

February 1984

\$3.95 U.K.

or you  
COLOR  
System 100  
agon & MC-10

# RAINBOW<sup>®</sup>

THE COLOR COMPUTER MONTHLY MAGAZINE

## ADVENTURE ISSUE

THREE EXCITING PROGRAMS INSIDE

**BASKETBALL:**  
TWO ON ONE SPECIAL  
STATS AND SIMULATION

INTRODUCING:  
RAINBOW  
CHECK PLUS

**RAINBOWTECH**  
A NEW SECTION

**BUILD YOUR OWN  
JOYSTICK FOR  
UNDER \$10**

**PLUS**  
GAMES GRAPHICS UTILITIES and  
MORE THAN 30 PRODUCT REVIEWS

**COMPUTERWARE  
SPECIAL SECTION**





32K MACHINE LANGUAGE

TAPE \$27.95

DISK \$30.95

By Rugby Circle



We've done it again! You thought The King was great? Wait 'til you see this!! Outstanding high resolution graphics, tremendous sound make this "Joust" type game a must for your software collection. As you fly from cloud to cloud you will enjoy sky high excitement dealing with the challenges presented to you by this newest release by Tom Mix Software.



**TOM MIX SOFTWARE**

3424 COLLEGE N.E.  
GRAND RAPIDS, MI 49505

To Order Call 364-4791  
To Place Orders After 5:00 P.M.  
Call Our BBS At  
(616)364-8217

•ADD \$1.00 POSTAGE & HANDLING•TOP ROYALTIES PAID•  
•MICHIGAN RESIDENTS ADD 4% SALES TAX•  
LOOKING FOR NEW SOFTWARE



**ARCADE ACTION GAMES**



From Computer Plus to YOU ...

# PLUS after PLUS after PLUS



Model 100 8K \$679  
Model 100 24K \$835



Color Computer II 16K \$145  
w/16K Ext. Basic \$210

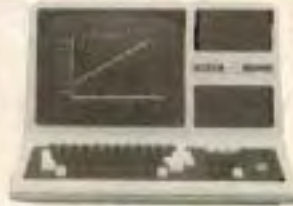

Model 4 16K \$849  
Model 4 64K  
2 Disk & RS232 \$1699



DMP120 \$395  
DMP200 \$520



CoCo Drive 0 \$329  
CoCo Drive 1 \$235



DWP210 \$629

## BIG SAVINGS ON A FULL COMPLEMENT OF RADIO SHACK COMPUTER PRODUCTS

### COMPUTERS

Model 4 Portable	
64K w/2 Drives	1525
Color Computer	
64K ext. basic	305
Pocket Computer 2	165
Model 12 1 Drive	2699
Model 16B 1Dr 256K	4249

### MODEMS

Hayes Smartmodem II	235
R.S. AC-3	129
R.S. Modem I	89
R.S. Modem II	160

### PRINTERS

Silver Reed EXP500 D.W. Ser.	455
Silver Reed EXP550 D.W. Ser.	665
CGP115	159
CGP220 Ink Jet	545
DMP100	315
DMP420	735
Gemini 10X	315
Delta-10	515
Gemini 15X	399
CITOH Prowriter	375

CITOH Prowriter II	649
Okidata	CALL
Epson	CALL

### ETC.

Disk Drive Controller	139
Extended Basic Kit	69
Botek Ser/Par Conv.	69
64K Ram Chips	75
R.S. Deluxe Keyboard	35.95
Superpro Keyboard	69.95
CCR-81 Recorder	52
R.S. Deluxe Joystick (each)	35.95
R.S. Joysticks (pair)	22
Video Plus (monitor adapter)	24.95
Amdek Color 1+ Monitor	299

### SOFTWARE

	(Tape Version)
Zaxxon	39.95
The King	26.95
Trap Fall	27.95
Screen Print	19.95
Buzzard Bait	27.95
Devil Assault	27.95
Colorpede	29.95
Juniors Revenge	28.95

Pac Attack	24.95
Block Head	26.95
Froggie	24.95
Lunar Rover Patrol	24.95
Lancer	21.95
Color Zap	9.95
Typing Tutor	19.95
Galagon	24.95
Scott Adams Adventures	19.95
Sea Dragon	34.95
Colorcome	49.95
Telewriter 64	49.95
FHL Flex (disk)	69.95
O-Pak (disk)	34.95
Key-264K	35.95
Elite-Calc	59.95
VIP Writer	59.95
VIP Calc	59.95
VIP Terminal	49.95
VIP Database (disk)	59.95

Order any 2 software pieces listed and take 10% off their listed price. All R.S. software 10% off list. Send for complete list.

## CALL TOLL FREE 1-800-343-8124

- LOWEST POSSIBLE PRICES
- BEST POSSIBLE WARRANTY
- KNOWLEDGEABLE SALES STAFF
- TIMELY DELIVERY
- SHOPPING CONVENIENCE



# computer plus

P.O. Box 1094  
480 King Street  
Littleton, MA 01460

SINCE 1973

IN MASSACHUSETTS CALL (617) 486-3193

# Under the Rainbow

## FEATURE ARTICLES

- Rainbow Check Plus/ H. Allen Curtis** ..... 21  
**Utility** New Rainbow Check for CoCo and the MC-10
- The Search For Merro's Crown/ Jeff Craig** ..... 26  
**Adventure** The Amazon jungle is rife with hazards
- Recipe For Adventure/ Eric W. Tilenius** ..... 33  
**Adventure Tutorial** The well-done Adventure requires a proper mix of elements
- The Making Of An Adventure/ Bob Liddil** ..... 52  
**Adventure Tutorial** Advice on creating the Adventure program
- Cavern Copter/ Jason Nannen** ..... 64  
**Game** Your mission is to recover a precious artifact
- The CoCo Open/ Mike Knolhoff**  
**Game** In micro-golf do they yell "Point Fore?"
- All In The Family/ Richard Seaberg** ..... 78  
**Genealogy** A file program
- The Mysterious Epistle/ Michael J. Himowitz & Julius Nelson** .... 88  
**Printer Graphics** A printer mystery Valentine
- The Amazing Adventures Of Karrak/ Gregory Clark** ..... 90  
**Adventure** Exploits of the potent paladin with the palendromic praenomen
- Winter Wonders/ Andrew L. Shemo** ..... 120  
**Graphics** Let CoCo draw a winter wonderland
- Creating Solid Documentation/ Robert K. Tyson, Ph.D.** ..... 130  
**Commentary** Eight steps to better documentation
- The Computerized Scorecard/ Richard A. White** ..... 140  
**Sports Statistics** CoCo works up basketball stats
- A Slam Dunkin' Simulation/ Gary L. Carter** ..... 160  
**Game** Make your own on-court action decisions
- Cheapstick — A Joy For Under \$10/ J.D. German** ..... 186  
**Hardware Projects** Build your own rugged, inexpensive joystick
- Keyboard Shorthand/ Roger Schrag** ..... 188  
**Utility** A handy keystroke multiplier for programmers
- What Is Image Processing?/ Robert K. Tyson, Ph.D.** ..... 196  
**Graphics** Filter noise from useful information
- Are You Compatible?/ Simon Clift** ..... 292  
**Game** Test your compatibility rating with spouse or friends
- Tiny Dump/ Dave Anthony** ..... 306  
**Graphics** A two-line graphics dump to the DMP-100



26



90



196

COVER art © by Fred Crawford

**NEXT MONTH:** March is our Business iss and in small businesses. For instance, we'll show you how to use an electronic spread sheet program to organize a business trip and how to use it to keep track of auto expenses. We also will have a cost calculation program for business use, a listing to provide first-time buyers a look at the total cost of home ownership, a program to project the effects of inflation and a special called "Lil' Ole Person's Goldpile."

It won't be all work and no play for CoCo in March, though, because our March issue has a full measure of games, utilities, home helpers and educational programs — including some three dozen hardware and software reviews.

In March, as in every month, look to *the Rainbow* for more on the Color Computer than is available from any other source.

## DEPARTMENTS

Advertiser Index .....	337
Assembly Corner/ <i>Dennis Lewandowski</i> .....	281
Taking the correct approach to problem solving	
Back Issue Information .....	282
Basic Training/ <i>Joseph Kolar</i> .....	284
Making the ABCs out of graphic characters	
Bits And Bytes Of BASIC/ <i>Richard White</i> .....	154
Answers to some basic questions	
Building February's Rainbow/ <i>Jim Reed</i> .....	16
A many-hued preview to this month's issue	
Captain Eighty/ <i>Bob Liddil</i> .....	205
Stylish Adventures	
CoCo Clubs .....	290
Corrections .....	334
The Dragon's Byte/ <i>Bill Nolan</i> .....	178
A character generator program	
Education Notes/ <i>Steve Blyn</i> .....	60
Drawing and saving pictures	
Education Overview/ <i>Dr. Michael Plog</i> .....	62
Microcomputers vs. the mainframes in school	
GameMaster's Apprentice/ <i>Bob Albrecht</i> .....	296
Saving your role-playing characters to tape	
Greetings From Uncle Bert/ <i>Dale Peterson</i> .....	301
Wishing upon a star	
Letters To Rainbow/ <i>Our Readers</i> .....	6
The Pipeline/ <i>Staff</i> .....	150
PRINT #-2,/ <i>Lawrence C. Falk</i> .....	14
Editor's Notes	
RAINBOW Info .....	194
Rainbow Scoreboard .....	202
Received And Certified .....	210
Reviewing Reviews .....	212
School Is In The Heart Of A Child/ <i>Fran Saito, Bob Albrecht</i> .....	132
A new column for young children and parents	
Submitting Material To Rainbow .....	154
Subscription Information .....	149
Turn Of The Screw/ <i>Tony DiStefano</i> .....	330
Making the program pak connection	
Using Graphics/ <i>Don Inman</i> .....	54
Pic is on the menu	

Tom Nelson's *CoCo Counsel* will return next month.

## RAINBOWTECH

The Advanced Operator/ <i>Frank Hogg</i> .....	332
Free up more OS-9 workspace	
Downloads/ <i>Dan Downard</i> .....	308
Answers to your technical questions	
KISSable OS-9/ <i>Dale L. Puckett</i> .....	324
Some technical potpourri	
OS-9 Meets The Wolfbug Monitor/ <i>William C. Clements, Jr.</i> .....	322
Switch on Wolfbug for OS-9 applications	
Prospecting The MC-10/ <i>H. Allen Curtis</i> .....	314
Hidden gold in the ROM	
Random Basics/ <i>Paul Searby</i> .....	310
The process of designing and developing software	

## PRODUCT REVIEWS

Product Review Contents .....	209
-------------------------------	-----

# THE RAINBOW

February 1984

Vol. III No. 7

Editor and Publisher  
Lawrence C. Falk

Managing Editor James E. Reed

Senior Editor Courtney Noe

Technical Editor Dan Downard

Copy Editor Susan Remini

Submissions Editor Jutta Kapfhammer

Editorial Assistants Valarie Edwards,  
Wendy Falk, Lynn Miller, Shirley Morgan,  
Noreen Morrison, Kevin Nickols

Contributing Editors Bob Albrecht, Steve Blyn,  
Tony DiStefano, Frank Hogg, Don Inman, Joseph  
Kolar, Dennis Lewandowski, Tom Nelson, Bill  
Nolan, Dale Peterson, Michael Plog, Dale Puckett,  
Paul Searby, Richard White

Art Director Sally Nichols

Assistant Art Director Jerry McKiernan

Designers Peggy Henry, Neal C. Lauron

Advertising Manager Charlotte Ford

Advertising Assistant Lynda Wilson  
(502) 228-4492

General Manager Patricia H. Hirsch  
Assistant General Manager for Finance  
Donna Shuck

Bookkeeper Diane Moore

Administrative Assistant to the Publisher  
Marianne Booth

Customer Service Manager Suzanne  
Kurowsky

Assistant Customer Service Manager  
Deidra Henry

Rainbow On Tape Subscriptions

Monica Wheat

Research Assistants Laurie Falk,  
Wanda Perry

Dispatch Mark Herndon

Garland Associates, Inc., is the advertising representative for The RAINBOW in the eastern United States. Advertisers east of the Mississippi may contact them for further information. Garland Associates, Inc., P.O. Box 314, S.H.S., Duxbury, MA 02331, (617) 934-6464 or 934-6546.

RAINBOW Advertising Representative for the western states: Cindy Shackelford

The RAINBOW is published every month of the year by FALSOFT, Inc., 9529 U.S. Highway 42, P.O. Box 209, Prospect, KY, 40059. Phone (502) 228-4492. The RAINBOW and The RAINBOW logotypes are ®. Trademarks of FALSOFT, Inc.

Second class postage paid Prospect, KY and additional offices. USPS N. 705-050 (ISSN No. 0746-4797). POSTMASTER: Send address changes to The RAINBOW, P.O. Box 209, Prospect, KY 40059. Forwarding Postage Guaranteed. Authorized as second class postage paid from Hamilton, Ontario by Canada Post, Ottawa, Ontario, Canada.

Entire contents © by FALSOFT, Inc., 1984. The RAINBOW is intended for the private use and pleasure of its subscribers and purchasers and reproduction by any means is prohibited. Use of information herein is for the single end use of purchasers and any other use is expressly prohibited. All programs herein are distributed in an "as is" basis, without warranty of any kind whatsoever.

TRS-80, Color Basic, Extended Color Basic, Scripsit and Program Pak are ®.

CompuServe is a ® Trademark of CompuServe Inc.

Subscriptions to The RAINBOW are \$28 per year in the United States. Canadian and Mexican rates are U.S. \$35. Surface mail to other countries is U.S. \$65, air mail U.S. \$100. All subscriptions begin with next available issue.

Limited back issues are available. Please see notice for issues which are in print and costs. Payment accepted by VISA, MasterCard, American Express Cash, Check or Money Order in U.S. currency only.

# RAINBOW

## ROOM AND BAUD?

Editor:

I recently saw the following ad on BUY-PHONE, Los Angeles' "Computerized Yellow Pages":

"ROOMMATE WANTED: I am looking for a roommate to share a two bedroom apartment in San Gabriel, CA. Rent is \$225/month. You also may have partial use of my IBM PC computer."

Is Los Angeles setting a trend towards "Room and Baud?"

*William Lappen  
Los Angeles, CA*

## A CHARITABLE CONTRIBUTION

Editor:

San Pable Institute, a non-profit public charity, is forming a computer education program for economically disadvantaged children in San Francisco, especially those whose families would otherwise be unable to afford computers and extensive instruction. The club is a free service program of San Pablo Institute. No membership fees are charged nor are children expected to pay for any club services. The computer club offers programming instruction and gives children an opportunity to meet and share ideas with other children interested in computers, allowing them to constructively apply their time, talents and intellect.

The San Pable Computer Club is seeking donations of computers and peripherals. Equipment that is donated will be lent out to club members for "hands-on" learning at home. All donations are tax deductible and we pay for shipping.

Get a tax break on that old clunker and receive the satisfaction of knowing that the computer you cut your teeth on is being put to good use by a kid that couldn't otherwise have a computer at home. To donate, please write me: San Pable Institute, 234 Mullen Street, 94110.

*Keith Wood  
San Francisco, CA*

## INFORMATION PLEASE

Editor:

First, I would like to congratulate the entire staff of *the Rainbow* for producing a truly fine magazine. I have been unable to find another magazine that is even comparable to yours. Thanks!

Also, I have been looking for what is called a "host" program for my Modem II. Is there such a program around for the CoCo? If anyone could help me I would greatly appreciate it. My address is 14 Sunset Trail, 07866.

*Scott Doering  
Rockaway, NJ*

## CAR GAMES WHERE ARE YOU?

Editor:

I am a subscriber to your helpful magazine. I am also a very concerned game player. My favorite kind of game is a car game. In the past months I've been looking for a program for a car game and there doesn't seem to be many in your magazine. If anyone who also reads the magazine is interested in helping me, send in your car games! Please!

*Scott March  
Barrie, Ontario*

## DRAWING DILEMMA

Editor:

Does anyone know of a machine language program to draw a line between two points in the highest graphic mode (6R)? I have a ML points routine and a great three-dimensional object rotation program that puts people to sleep watching Color BASIC draw. Please help: 2232 Grand Ave., 14301.

*Joseph Fiore  
Niagara Falls, N.Y.*

Editor:

I need a program that I can use my CoCo to send Telex overseas. I am not very familiar with this subject and so I sincerely wish you can give me some advice.

What kind of program I am looking for? Does anybody already have the program on the market? (for CoCo)?

Sure appreciate a quick answer. I am forming a company now and really wish my CoCo can do something for me. Thanks a million.

*Roland C. Wong  
El Monte, CA*

**Editor's Note:**

**There is a system from Western Union called "Easy Link" that can be used to send Telex, cables and all sorts of other stuff. You can buy a subscription from ComputerWare.**

Editor:

For a long time now I have wanted to start my own BBS, but since I am only 14 years old, I haven't had a lot of money for a BBS program. Then when I got your November issue on Data Communications, I was thrilled when I read the "Supreme Sysop" programs, but I have a question: Do I have to have a disk drive and disks to run it, or can I use cassettes?

*Ken Clark  
Washington, DC*

**Editor's Note:**

**Sorry Ken, a disk is required for this particular BBS.**

## COCO POWER

Editor:

Are CoCos better than Vic 20s, Commodore 64s, TI-99/4As and Atari computers?

I'd like to know because my friends think that CoCos are second rate computers and that Vic-20s have better graphics than CoCos do. Also I'd like to know about how many software programs there are for the CoCos.

I think that your magazine is the best TRS-80 Color Computer magazine. Thank you.

*Eric Onoferychuk*

**Editor's Note:**

**Give your friends a copy of the *Rainbow* and let them look at the ads. Ask them if all of these programs can run on their computers.**

Editor:

I would like to upgrade my computer to 64K. Being in Germany, I am unable to get the job done by Tandy, however, I understand there are chips on the market which are easily fitted by the owner. If you could give me any information on reliability of makes and ease of installation, I would be very grateful.

*Philip Judd  
Detmold, Germany*

**Editor's Note:**

**You need eight 4164 chips. Most suppliers give installation instructions.**

Editor:

Has anyone ever discovered how a program tape (from CoCo) can be loaded into a Model III? I want to use the Model III printing facilities but cannot load my CoCo type into the Model III. Can anyone advise? My address is Box 504, 12839.

*Glenn Churchill  
Hudson Falls, NY*

Editor:

I have recently purchased a GEMINI-10X printer. I am very pleased with its capabilities, yet I am having a difficult time understanding how to use the Bit-Imaging and the downloadable characters. The manual that came with it was much too vague for me to comprehend it. Any help would be greatly appreciated.

*Rich Trawick  
North Adams, MI*

## ADVENTURE: PITS AND TIPS

Editor:

I tried out many Color Computer magazines and found yours was the best. There was so much in it compared to other magazines.

I just purchased two Adventure games: *Pyramid* and *Madness and the Minotaur* from Radio Shack, about two weeks ago. Right now I am stuck in both.

In *Pyramid*, I can't make it past Pharaoh's chamber, the one with the serpent in it. And in *Madness and the Minotaur*, I'm having problems getting out, killing monsters and obtaining spells. If you know the solution to any or all of my problems, then send it to me at: 203 South Road, 06447.

Jay Aust  
Marlborough, CT

Editor:

To all those Adventure addicts out there who are having difficulty getting past the snake in *Pyramid* or are stuck at the sarcophagus in *Sands Of Egypt*, don't despair. Here are some hints from someone who was once in the same predicament. In *Pyramid*, the bird statue will defeat the snake when thrown if you find a way to carry it, but beware the ANKH STAFF. The last treasure that no one can seem to find is within the maze, past the pit. When you find the pit in the maze, go east once more then northwest, and don't ever waste the coins on batteries.

In the *Sands Of Egypt* you must place the scepter on the sarcophagus to get to the treasure room. If you didn't get this far, then you must go into the pool and drain it, then go down with the torch lit and use the boat and shovel as an oar. What ever you do, don't

drink the water in the stream. Good luck and keep Adventuring.

Steve Jeromos  
Hauppauge, NY

## HINTS AND TIPS

Editor:

Frank Garhau's line voltage fluctuation problem is not uncommon. May I suggest that he, and all others with this problem, purchase a constant voltage transformer. Not only do these correct for line voltage fluctuations but also offer excellent protection against over voltage surges. For computer use only, a 30VA size is adequate however to feed the CoCo and the disk drive, a 60VA size would be required. The best known supplier of CV (constant voltage) transformers is Sola Electric Co., 1717 Busse Road, Elk Grove Village, Ill. They can supply the names of a distributors. Allied Radio, Ft. Worth, Texas also has CV transformers.

Francis Sherwood  
Ft. Pierce, FL

## CHANGING A ROUTINE

Editor:

In *POKEing* up the *Disksort* routine submitted by Matt Stephens on Page 64 of the December issue, I found that it performed two sort routines, the primary sort was on the "EXT" and secondary sort on "FILENAME," hence the final product is

alphabetical on the EXT first and FILENAME second. In order to list the "FILENAME.EXT" in alphabetical order, the following changes were made. Delete lines 190 thru 260 and make the following change to line 270.

```
270 FOR X=1 TO S:ES(X)=MID$(F$(1),
9,3):NEXT X
```

By making this change, the routine runs very good in sorting the directory by file name.

Since all of my files and other material is listed in alphabetical order I found this routine extremely helpful in allowing my directories to also be the same way. Thank you, Matt, for an excellent utility.

Barry Baker  
Pacific Beach, CA

Editor:

You know how good *Rainbow* is so I don't need to tell you that, just that I love it and don't even thumb through the other CoCo magazines any more. Here's a handy hint I don't think I have heard of anywhere:

For short but frequently used programs, I keep one working copy of each on Realistic Endless Loop cassettes (R.S. Cat. No. 43-401 for 20 second loop or 43-403 for 15 second loop). The big advantage is never having to rewind these utility tapes. Just insert cassette, *CLOAD*, and *RUN*. This saves time and you don't feel guilty about wasting tape by *CSAVEing* only one program on a regular cassette.

I'm using a 16K ECB CoCo, Epson MX-80 with Micro Works S/P interface and a



## The Best Selling Program for Young Children Now Available for: TRS-80 Color Computer- 16K disk or cassette and TRS-80 Models I/III-32K disk or 16K cassette

Nine fun educational games for children ages 2½ to 6

counterpoint software, inc.  
4005 West Sixty-Fifth Street  
Minneapolis, Minnesota 55435

Phone Orders: 800-328-1223  
Minnesota: 612-926-7888

Educators Endorse: "Early Games can help children learn new concepts, information and skills, and also introduces them to the joys and benefits of home computers."

Peter Clark, Faculty  
Institute of Child Development  
University of Minnesota

No adult supervision required. The Picture Menu gives children control. They can:

- Match Numbers
- Match Letters
- Count Colorful Blocks
- Learn the Alphabet
- Add Stacks of Blocks
- Spell their Names
- Subtract Stacks of Blocks
- Compare Shapes
- Draw and Save Colorful Pictures

All  
nine games  
for \$29.95

**Yes!**

Please rush me *Early Games for Young Children*

Circle one:  
Model I Disk      Color Computer Disk      Model I/III Cassette  
Model III Disk      Color Computer Cassette

Name \_\_\_\_\_

Address \_\_\_\_\_

City \_\_\_\_\_ State \_\_\_\_\_ Zip \_\_\_\_\_

My check for \$29.95 is enclosed (Minnesota residents add 6% sales tax)

Charge to VISA       Charge to Mastercard

Acct. No. \_\_\_\_\_ Expiration Date \_\_\_\_\_

\$39.95 Panasonic Portable Tape Recorder.  
Don Langer  
Duncanville, TX

Editor:

Regarding Craig M. Arnold's hint in December on undocumented edit commands A, Q and E:

Also undocumented is command nKc, a handy tool that deletes characters from the cursor position up to (but not including) the "nth" occurrence of character "c," just as on the Model II or III.

Gary L. Carter  
Bloomington, Ill.

## FIREFLY'S REVENGE

Editor:

I caught an error in Josef A. Laake's program, *The Laserworm and The Firefly*. In line 26 it reads:

```
26 POKE 65495,0: CLEAR 350,16375
```

The periods should be commas. The line should read as follows:

```
26 POKE 65495,0: CLEAR 350,16375
```

Jim Partridge  
Clinton, CT

Editor:

For those going to disk systems for the first time and experiencing difficulty with the high speed *POKE* (65495,0) do the following:

Use a soldering iron or wire cutters to lift one leg of C85. This is a little disc ceramic capacitor near pin 40 of the cartridge connector. I have an "E" revision CoCo. The CP number (C85) may be different on other revisions.

Also, I would like to correspond with anyone who has built up and is programming the general automation A43-8910, music synthesizer project. If interested, please write to me at 5131 Raywood Lane, 37211.

Brian Carling  
Nashville, TN

## A WINNING TIP

Editor:

I truly enjoy your magazine, and was especially interested in Joe Kohn's *Color Blackjack* which appeared in the October 1983 issue.

I understand why Mr. Kohn chose to randomize his bets, but in reality few people use this method.

A winning tactic would make use of the card counting techniques spoken of in the article. I offer the following lines of code to do just that.

Anyone interested in how the calculations were arrived at would also be interested in the book "Beat the Dealer" by Edward O. Thorp.

```
900 IF QWL2 THEN BT=10 ELSE BT=10 * QW:BT$=MID$(STR$(BT),2):DRAW"BM20,102;C4":X$="your bet is $"+BT$+"!":GOSUB 1490
```

```
905 BT$=MID$(STR$(BT),2):DRAW"BM20,102;C4":X$="Your bet is $"+BT$+"!":GOSUB 1490
```

```
1290 QW=QW+ZY:LINE(0,68)-(255,
```

```
102),PRESET,BF:LO=0  
1675 QW=0  
1770 ZY=0:T=0:FORX=0 TO K  
'A=NUMBER OF ACES  
1781 IF CV(CD(H,X))> THEN 1785  
1783 IF CV(CD(H,X))<7 THEN 1787  
ELSE 1790  
1785 ZY=ZY - 1:GOTO 1790  
1787 ZY=ZY + 1
```

Lines 900, 1290, 1770 would be easiest to edit to make changes. The others should be added to existing program.

Philip A. Brouillet  
Queens, NY

## WHAT'S IN THE NAME?

Editor:

Ever since I bought my 32K Color Computer with a disk drive in January, I have met sharp prejudice when I mention that I have a Color Computer. I love this machine and find it to be more powerful than machines costing two and three times more. So I set out to find the reason for their ridicule; and I can now share my findings with you. It's the name, "Color Computer," a child's toy.

I may have also found a way to get over their put downs, *change the name!* I say we call our powerhouses the Model VIII (reason: an eight bit microprocessor). People will think it is some new innovative TRS-80, and the CoCo will finally get the recognition it deserves.

Mark Charney  
Denville, NJ

## WILD AND CRAZY CRIME

Editor:

I am enclosing the original of a clipping from the *Des Moines Register* dated October 13, 1983, captioned "Woman sues over computer message." The body of the short article indicates she filed the lawsuit (civil, not criminal) because her boyfriend called her computer terminal and left a message intended to intimidate and annoy her.

IOWA CITY, IA.(AP)—An Iowa City woman claims in a lawsuit that a former boyfriend harassed her by sending a message to her computer terminal.

In the suit, filed in Johnson County District Court, Lisa Schmidt alleges that James Brucher, also of Iowa City, sent a harassing message to her computer terminal. The message, according to court documents, said Schmidt was a "wild and crazy woman."

Schmidt said she and Brucher had dated, but were not dating at the time the incident allegedly occurred.

Schmidt claimed Brucher typed the message with the intent to intimidate and annoy her.

My first reaction was amusement, but on reflection, it occurred to me that many persons might not realize that in Iowa and many other states, it also constitutes a crime to use the telephone in this manner. With the proliferation of home computers and modems, people should be made aware that they

should not call someone with a modem to harass or intimidate them.

J. Hobart Darbyshire  
Iowa District Court Judge  
Davenport, IA

## BULLETIN BOARD SYSTEMS

Editor:

We'd like to let the readers of *the Rainbow* know about our new Bulletin board, the Falcon Color-80, that is now online 24 hours a day in California. We're a CoCo board, but we welcome all computer users.

In addition to our electronic mail section, we also have full upload and download capabilities. We welcome comments on our BBS, and hope to hear from your readers soon. The Falcon 437-3663.

Craig, Keith and Dan Daniel  
Fairfield, CA

Editor:

As a follower of all the great services your magazine gives, I would like to say thanks.

And now offering another great service for the CoCo, I am introducing "Creme De CoCo," Chicagoland's very first Bulletin Board service offered exclusively and most comprehensively for the Color Computer. The number is (312) 597-8485 and is available 24 hours, seven days a week except for occasional maintenance.

Eric Thred  
Blue Island, IL

Editor:

Saginaw's first Bulletin Board for the RS Color Computer is now undergoing testing. Technical information: protocol—8 data bits, 1 stop bit, no parity; Baud, 300; data line, (517) 793-1579; hours (E.S.T.), 4 p.m. to 10 p.m. Monday-Friday, 10 a.m. to 10 p.m. Saturday-Sunday; LOGON [ENTER]. For more information write 4814 Schneider St., 48603, or call 793-9035.

Tom Schopp  
Saginaw, MI

## A WEAVING WEB

Editor:

I have an idea for what I think will bring some *Rainbow* reader/programmer a lot of fame. My idea is for a game for the CoCo called "The Tholian Web." Remember the famous Star Trek show? If I could write the game I would, but I'm not that good yet. The object of the game would be to try and beam aboard all persons alive from a damaged starship, before the Tholians complete their web, then escape the web. The other starship would be "blinking" out often to make the game hard. Also, include 100 people on the ship and your transporter can only beam six at a time. The ship will appear at different locations, unknown to you. This game could be done in Extended BASIC. And *Rainbow* could print it! So, all you *Rainbow* readers who are looking for a new project, I dare you to try this one. Who knows, you may be famous for it one day! My address is 1502 Holly St., 39437.

J. Michael Long  
Ellisville, MS



# Give up on Word Processors for Fast Letter Writing & Mailing Labels

Instead use the

## DATABASE/MAILER 2.0 & LETTER WRITER 2.0

for FAST single page letters or  
1000's of form letters and labels

SEE EXCELLENT REVIEW DECEMBER 1983 ISSUE



plus shipping  
and handling



See Rainbow's  
**Coupon Page**  
in this issue for  
additional **savings!**

### NO WORD PROCESSING EXPERIENCE NECESSARY

#### — CC-DBM2/LW2 USES —

- Accounts
- Insurance
- Proposals
- Bulk Mail
- Dental Recall
- Lost Card Reporting
- Change of Address
- Christmas Lists/Labels
- Churches
- Club Membership
- Realtor Listings
- Sales Records

#### — BIG SYSTEM FEATURES —

- Active menus guide you to valid operations.
- 32K system allows 68 to 454 records per file.
- 16K system allows 13 to 95 records per file.
- 4 - 10 fields, 5 - 27 field widths, 20 - 270 char/record.
- All user definable with default values - simple.
- Memory sense adjusts files to system size.
- FAST key index sort by any field you choose.
- Adjusts for empty address lines - no gaps.
- Up to 9 line labels with up to 500 copies each.
- Master two column printout with field names.
- Master printout includes date, paging & filename.
- Selective printing by any field or field range.
- Accepts alpha or numeric zip codes up to 9 digits.
- Partial or whole item search by any chosen field.
- Single screen 10 record display by any field.
- Single key entry for hard copy of screen data.
- Fast single page letter writing with wordwrap.
- Embedded commands center, tab and line skip.
- Full screen edit allows delete, insert & change.
- Headings and closings are tabbed, spaced and printed - all automatically.
- No "Database Adventure" - over 40 page manual.
- Manual includes program operation flowcharts.
- Not needed, but included is user modification section.
- And many more features - too numerous to list.

**We ship within 24 hours**

**Call our 24 hour orderline  
619-695-1385**

or 619-566-6013, 9 — 5 p.m. PST weekdays  
or send check or money order to:

## EVS ENGINEERING

9528 Suite 35, Miramar Road  
San Diego, CA 92126

When ordering please provide:

NAME  
ADDRESS  
CITY/STATE  
ZIP CODE  
PHONE  
TAPE or DISK  
CREDIT CARD NO.  
EXP. DATE

Master Card holders —  
include interbank no.

Please include the following:  
\$3 postage and handling  
U.S. funds only  
CA residents add 6% tax  
COD orders add \$2

Dealer inquiries invited

Personal checks — OK  
we won't make you wait.



"Serving the Defense and Space Industry since 1979"

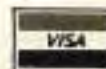

# TRS-80® Color

Come to Radio Shack

16K Standard  
Color Computer 2

**15995**  
26-3026

Was \$239.95  
In Cat. RSC-10

16K Extended  
Color Computer 2

**19995**  
26-3027

Was \$319.95  
In Cat. RSC-10

USE YOUR



**Great Savings.** We've cut the price of our most popular family computer by 33% over last year's price! With its compact, white case and electric typewriter-quality keyboard, the TRS-80 16K Standard Color Computer 2 is truly your best buy!

**Ready-to-Use.** Just attach your Color Computer to any TV and plug in a Program Pak™ to set up a household budget, track investments, help your kids sharpen math and reading skills—or play exciting space, sports and logic games!

**Learn to Program.** It's easy to teach yourself to program with the help of our entertaining beginner's manual. Simplified commands make it easy to program in eight vivid colors and sound. In no time at all you'll be producing



TP-10  
Thermal  
Printer

**9995**  
26-1261



CGP-115  
Color Graphics  
Printer

**19995**  
26-1192

# Computers at New Low Prices!

## for Printers, Software and More for Your Color Computer

great-looking drawings, charts and diagrams! The Standard BASIC language includes data and string handling capabilities, dimensioned arrays, math functions and 9-digit accuracy.

**Easy to Expand.** The Color Computer expands when you're ready with a cassette recorder, joysticks, color mouse controller, printer and telephone modem. You can add more memory and up to four disk drives, too!

**Extend Your Abilities.** Want to create high-resolution graphics or write sophisticated programs? Then the 16K Extended Color Computer 2 is the answer. You'll find it's easy to create elaborate geometrical shapes and drawings—even simple animation! You can even teach yourself how to create your own arcade-type games. You get all the great features of the 16K Standard version, plus Extended Color BASIC's powerful programming features, such as PEEK, POKE and USR commands, multi-character variable names, string arrays up to 255 characters, full-featured editing and tracing. You also get both the Standard and Extended BASIC tutorial manuals, so you can become an expert programmer in no time at all.

**CGP-115 Color Graphics Printer.** A perfect match for the Color Computer. It easily prints charts, graphs, computer-generated "doodles," programmed pictures and more in red, blue, green and black on 4 1/2"-wide paper. Commands built into this "smart" printer simplify drawing and plotting. Text mode prints 40 or 80 characters per line at 12 characters per second. Software controls additional character sizes and rotation. The CGP-115 uses easily replaceable ink cartridges. Measures only 2 15/16 x 8 1/4 x 8 1/2" and weighs just 1 3/4 pounds!

**TP-10 Thermal Printer.** The affordable way to get program listings, text and data printouts. Prints non-color graphics, too. And TP-10's thermal operation is so quiet you'll hardly know it's there! Text mode prints 32 characters per line at 30 characters per second. A special repeat function makes graphics programming easier than ever! Uses 4 1/8"-wide paper. Measures just 3 x 8 x 5".

**Available Nationwide.** Find out how your family can benefit from owning the exciting Color Computer 2. Visit your nearby Radio Shack Computer Center, participating store or dealer today and ask for a "hands-on" demonstration.

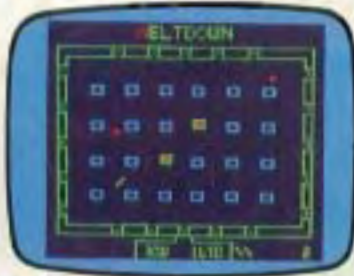

**New! Reactoids\* Tests Your Skill**

**1995**  
26-3092

**Stop the Atomic Threat**

Meltdown at a fusion reactor! Take control of the reactor's computer system to try and contain the wandering atoms! A real-time game to test your skill and dexterity.



**New! Dungeons of Daggorath™  
—The Ultimate in Adventure**

**2995**  
26-3093

**Find the Hidden Treasures**

You're pitted against a succession of awesome beasts. Each victory brings you closer to your enemy—the wizard!

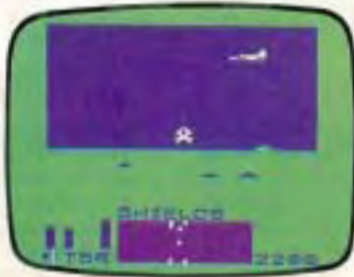

**New! Star Blaze\* for Galactic Fun**

**1995**  
26-3094

**"Captain, What Are Your Orders?"**

Your mission: protect the Milky Way. Seek and destroy alien vessels, then check the radar for the next wave. There's no let-up in the excitement.



**New! Baseball\* for Great On-the-field Sports Fun**

**2495**  
26-3095

**Hit 'Em!  
Field 'Em!**

You're in full control of this exciting sports simulation. Lets you bring the World Series home!

**Your Nearby  
Radio Shack  
Has the Latest  
in Color  
Software**

\* Joysticks required

Send me your free TRS-80 Computer Catalog.

Mail To: Radio Shack, Dept. 84-A-624  
300 One Tandy Center, Fort Worth, Texas 76102

NAME \_\_\_\_\_  
ADDRESS \_\_\_\_\_  
CITY \_\_\_\_\_ STATE \_\_\_\_\_ ZIP \_\_\_\_\_  
TELEPHONE \_\_\_\_\_

**Radio Shack®**

**The biggest name in little computers®**

A DIVISION OF TANDY CORPORATION

# eeny meeny miney mo

## FIVE HOT GAMES FOR YOUR HOT CoCo

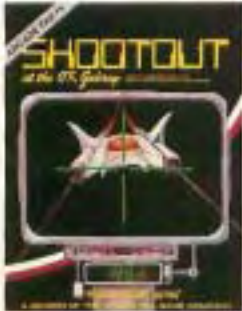

ARCADE



WARGAME



SCIENCE FICTION



SPORTS



WARGAME



Shootout Screen

### SHOOTOUT (at the OK Galaxy)

30 ALIEN WARSHIPS HAVE ENTERED YOUR PATROL ZONE. OK, shields up?, energy level . . . check, azimuth set? Yup. This may sound like the latest summer space movie thriller but in fact it's the preparations YOU will make when playing Avalon Hill's new **arcade** strategy game SHOOTOUT AT THE OK GALAXY. Over 2 years in the making, SHOOTOUT is purely graphical combining arcade excitement with just the right touch of strategy.

Cassette for TRS-80® Color (16K): \$20.00

### VOYAGER

A solitaire **science fiction** game that challenges you to explore the four levels of an alien spacecraft's maze-like corridors and rooms in 3-D simulated graphics, all the while avoiding robots programmed to blast any intruders. In order to win, you must destroy all power generators and escape or hunt out and annihilate all of the killer robots. VOYAGER comes with color-animated graphics and sound capabilities for computers so equipped.

Cassette for TRS-80® Color (16K): \$20.00

### MIDWAY CAMPAIGN

Your computer controls a huge force of Japanese ships whose objective is to invade and capture Midway Island in this tense **wargame**. In the actual engagement, the Japanese made several tactical errors which cost them the battle. Your computer probably won't make the same mistakes! You command the badly out-numbered and outranged U.S. Naval Forces. Your only advantage is surprise.

Cassette for TRS-80® Color (16K): \$16.00

Whether your interest is in quick-reflex **arcade** games, **sport** simulations, **science fiction** adventures or **war** games, you're sure to find many challenging contests from Avalon Hill's **Microcomputer Games**. Your only problem will be deciding which one to pick!

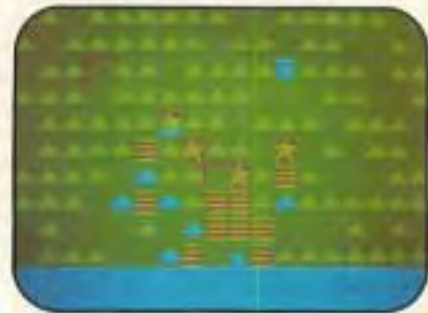

V.C. Screen

### BREAKTHRU (in 3-D)

Don't take our word for it! Here's what *Color Computer* magazine has to say: "This is truly a good game". Short and sweet as this description may be, BREAKTHRU is really much more than just a truly good game! It's a combination of racquet and WALLBALL. The object is to knockout five consecutive walls at the opposite end of the court using a joystick paddle to strike or deflect the lively ball. BREAKTHRU is written in pure machine language to give you a fast-action, three-dimensional, high-resolution **sports** experience for hundreds, maybe even thousands of hours of entertainment.

Cassette for TRS-80® Color (16K): \$20.00

### V.C.

V.C. (short for Viet Cong) is Avalon Hill's first **wargame** on the controversial Viet Nam War. Under your command is the chopper based air-mobile and heavily armed 1/509th Air Cavalry and 9/15th Field Artillery for fire support. It is an unconventional conflict. You have the task of bringing the civilian population under your protection where the enemy can hide amongst the people, and where the politics of terrorism and friendship can turn the people you want to save against you. V.C. faithfully re-creates this struggle in which you can lose without ever being defeated.

Cassette for TRS-80® Color (16K): \$20.00

® Trademark of Tandy Corporation

## TAKE YOUR PICK NOW!

THESE GAMES ALSO AVAILABLE FOR MOST OTHER COMPUTER SYSTEMS AT LEADING COMPUTER GAME STORES.

Call Toll-Free for more information:  
1 (800) 638-9292. Ask for Operator C.



# microcomputer games®

A DIVISION OF

## The Avalon Hill Game Company

4517 Harford Road • Baltimore, MD 21214 • (301) 254-5300

## A DIFFERENT STANCE

*Editor:*

Your stand against software piracy is admirable and some of the measures that you have taken will surely have a positive effect, but I think you are off the track on one point. Specifically, your request that all tape copy utilities be removed from the market. This type of utility is essential for anyone that is trying to manage a reasonably large tape-based software library. Besides, anyone that is skilled enough to write a valuable program could easily protect it against a general purpose tape copy utility. I have written and marketed a utility program that, among other things, will, as advertised, copy "virtually" any program. The reason that I was able to do this was, up until now anyway, "virtually" all software for the Color Computer is minimally protected. A far more damaging program, which I would not advocate removing from the market, is the disassembler. Although it is very easy to defeat a general purpose copy utility, I challenge anyone to encrypt a program such that I could not "break" it with the help of a disassembler.

In my opinion, your stand on this particular issue will be more damaging than beneficial to the CoCo community.

*Darrel Price  
DP Development*

*Editor:*

In the letters to *Rainbow* column of the December issue there is a letter from Ron Krebs of Mark Data Products. In the letter, Mr. Krebs states that none of their software is protected.

Well, Mr. Krebs, I own tape copies of both your *Astro Blast* and your *Color Haywire* programs and they are both autoexecuting with no way to back them up or convert them to disk.

If this is not protected, then what do you call it?

*Marlin Simmons  
Bridgewater, VA*

*Editor:*

I have been following the controversy about piracy in your magazine with some interest. As a software producer I am interested in both a personal and professional way, and when I chose to publish *Omni-Clone* and *Clone-Master* I made it clear that I believe the consumer has a right to make backup copies of their tapes and disks to prevent loss.

Nevertheless, I have seen several letters from consumers that seem to make the same point (the latest was in your December issue), and I must respond.

The premise of these letters seems to be that commercial software for the Color Computer is overpriced, and thus it is fair game for the pirates. To quote one letter: "... and another firm puts out a lousy program for \$17.95, so who is the pirate?"

Frankly, I find this entire premise to be so much throughput from male cows. I personally think that new cars are high in price, but that certainly gives me no right to steal them! It amazes me that anyone could even suggest such an idea.

As consumers you have the final power in this market, but it isn't the power to steal and then justify it with some self-righteous gobbledegook. It's quite simple. If I think the cars are too expensive, I am free to not buy them, and as a merchant, I am free to price my products however I like. If someone thinks a program is too expensive, they are free to keep their money in their wallet. If you think differently, try shoplifting something from a high priced store in your area, and then tell the judge it was okay, because the stuff was overpriced anyway. No, that's just not how it works. But, as the man said in the last line of his letter, "everyone wants an alibi."

*William A. Nolan  
Prickly-Pear Software*

## KUDOS

*Editor:*

Thank you for the excellent quality magazine you are publishing. It gets better with every issue. I would like to suggest that you publish more articles on the fundamentals of machine language programming. Many of the articles involving this type of programming are hard for me to understand, probably because I don't know what's going on.

*Paul Cournoyer  
Ballston Spa, NY*

*Editor:*

Thank you for publishing a truly informative and excellent magazine. Please keep up the articles on assembly language, and the hardware articles. There should be at least one, maybe two or three hardware articles each month in *Rainbow*. I will try to eventually contribute some ideas or articles myself.

*Brian Carling  
Nashville, TN*

*Editor:*

*The Rainbow* is the greatest thing that has happened to the Color Computer.

My thanks to Dan Downard for the CoCo Nets on Amateur Radio. I'm glad I also get *Rainbow On Tape*. The Amateur Radio-Frequency Allocations by B.B. Witham Jr., in the December issue, is a long one. I also like Jorge Mir's "practical" programs.

*Hamilton C. Appawa  
Chicago, IL*

## HOW DOES NIDA SPELL RELIEF?

*Editor:*

Relief can also be spelled FRAYSSE, for allowing himself to be on call when uncoordinated fingers fumble through his *Marathon*. And what a game that is! I'm too old and slow to play and succeed, but my kid plays it with *POKE 65465.0* although he occasionally slightly decreases speed by pressing the fire button.

I will continue to read *Rainbow* in hopes of learning all things wonderful, including what is a "bubble sort"; "screen dump"; "concatenate"?

*Nida Lewis  
Follett, TX*

*Editor:*

I find your magazine very interesting and useful. The balance of software, hardware and tutorial articles is excellent! The continuing good articles are strong evidence that the CoCo is a powerful machine and a great choice for home computing.

One program I really enjoyed was *Rainbow Roach* by John Fraysse. I sent him a tape and he promptly sent back a copy which I found to be a super game. In fact a friend, who is an Apple devotee and sold computers for a while, was flabbergasted that such a fast, High-Res program could be done on a lowly CoCo. I'll be expecting to see more articles from John.

Keep up the good work! You have the best CoCo magazine going!

*Mike Spring  
Utica, MI*

## BOUQUETS AND BRICKBATS

*Editor:*

I just received a defective keyboard (which I'm sure does not occur very often). I sent it back for repair. The board was lost in transit.

After one phone call we (H.S.L. Products and I) came to an agreement that they would replace my keyboard and this was just on my word that if they did not receive the board and after the claim from our postal services came across, I would send them the amount of the claim (which might take up to six months).

As far as I'm concerned, H.S.L. is top notch in my book and I recommend their services. As the saying goes "you learn something new everyday."

My lesson for today is there are still some people who are honest, reliable and most of all have respect for customer relations.

Again, H.S.L., thank you.

*Richard Nantel  
LaSalle, Quebec*

*Editor:*

I'm not one to complain but in this case I've just got to speak up. My "beef" has to do with the advertisements I see in *Rainbow*.

Now, I don't want you guys to stop using pretty girls to catch the reader's attention, but there are quite a few feminine fingers flickering over the keyboard (me, for one) and speaking for myself I wouldn't mind seeing a nice looking young man touting software, or hardware for that matter. A good looking guy smiling over a disk drive or, say, showing the maneuverability of a joystick would catch my eye and hold my attention at least long enough to find out who the dealer is.

I really do think you produce one of the best magazines for the CoCo around. I really look forward to mine coming the first part of every month, that is if the postman doesn't decide to read it first.

*Evalea A. Siverly  
Terre Haute, IN*



This is our big Adventure Issue and it is a pretty auspicious occasion for *the Rainbow*. First of all, this marks the beginning of our Second Annual Adventure Contest and the publication of the first book that Falsoft, Inc., our parent firm, has ever put out.

I was really pleased with the first Adventure Contest for several reasons. First of all, it made us a lot of new friends, and second, it brought some real quality programs to *the Rainbow* and to you. And we expect that this year's contest will be much the same — but, probably more so.

First prize in the Second Annual Rainbow Adventure Contest is a complete disk drive 0, including controller. This prize is being offered by *the Rainbow*. Other prizes will be announced next month but, this time around, everyone who enters gets a bonus: A free three-day pass to the **RAINBOWfest** of his or her choice. When you send in your entry, please specify which **RAINBOWfest** you want your free ticket for.

The rules for the Second Annual Rainbow Adventure Contest are pretty much the same as last year. All programs become the property of Falsoft, Inc., and none can be returned. By

entering the contest you warrant that the work is yours originally, and that you have the right to offer it as yours. Winners will be notified by mail and telephone, so please make sure we have both your address and telephone number.

Finally, there is the deadline. All entries must be postmarked on or before May 1, 1984. (We have extended our March 1 deadline that we previously announced.) Also, entries *must* be submitted on magnetic media — disk or cassette. Please be sure to give us complete loading instructions and, as you feel necessary, give us plenty of information on the game. Also, for the purposes of judging, please give us the *answer* to the program. In order to properly judge the contest, we have to know how a player can win and what happens when he or she does.

Secondly, as you read this, *The Rainbow Book of Adventures* is available. You might check your local store that carries *the Rainbow* to see if they have it in stock. If not, you can order it from us or from several of the mail order firms which we anticipate will be advertising it. Cost of the book is \$7.95 (Kentucky residents please add sales tax if you order from us). A tape version of the Adventures is \$8 and, yes, just like *Rainbow On Tape*, you must have the book to get the instructions on how to load and run the programs on the tape.

We think both are a bargain. We've tried to keep the price low in order to make it as affordable as possible. There are 14 programs in the book and on the tape and the book is an attractive 100-plus pages with nice artwork, a four-color cover and a true "spine," just like *the Rainbow* itself.

I'm really proud that we have been able to publish this, our first book. More will be coming. And, it would be very inappropriate to mention *The Rainbow Book Of Adventures* without mentioning the names of Susan Remini and Peggy Henry, the editorial and art directors for this project. Both of them worked long and hard extra hours and are justifiably proud of what they have accomplished.

And we're proud to be able to bring it to you!

By the time you read this, **RAINBOWfest** will be close at hand in Long Beach, California. I believe it is going to be a great show, but I told you a lot about that a month ago so I won't repeat myself here.

However, we have some extra special things which have just come together that I think will add a little icing on the cake to this **RAINBOWfest** that will make it even more worth your while to come.

First, Phil Kitchen, who runs the Third Party Software Support operation for Radio Shack will be conducting a special seminar during the show. As you may know, Radio Shack has a program which helps software authors and Phil will be explaining the program at length. It will also give you an opportunity to ask questions concerning Third Party Support. It is a must if you are in the software business, or have any interest in becoming involved.

Second, Radio Shack will be conducting a show-long class on computing and CoCo during **RAINBOWfest**. Here's a great chance for some extra hands-on instruction about CoCo and, too, here is an opportunity for you to "turn on" a friend, neighbor, child or spouse to the wonderful world of CoCo. Admission to the classroom is included with your admission to **RAINBOWfest** itself.

All that, plus the best single Color Computer show ever held, makes Long Beach look great. I hope to see you there!

(continued on page 304)

# Telewriter-64™

## the Color Computer Word Processor

- **3 display formats: 51/64/85 columns × 24 lines**
- **True lower case characters**
- **User-friendly full-screen editor**
- **Right justification**
- **Easy hyphenation**
- **Drives any printer**
- **Embedded format and control codes**
- **Runs in 16K, 32K, or 64K**
- **Menu-driven disk and cassette I/O**
- **No hardware modifications required**

### THE ORIGINAL

Simply stated, Telewriter is the most powerful word processor you can buy for the TRS-80 Color Computer. The original Telewriter has received rave reviews in every major Color Computer and TRS-80 magazine, as well as enthusiastic praise from thousands of satisfied owners. And rightly so.

The standard Color Computer display of 32 characters by 16 lines without lower case is simply inadequate for serious word processing. The checkerboard letters and tiny lines give you no feel for how your writing looks or reads. Telewriter gives the Color Computer a 51 column by 24 line screen display with *true lower case characters*. So a Telewriter screen looks like a printed page, with a good chunk of text on screen at one time. In fact, more on screen text than you'd get with Apple II, Atari, TI, Vic or TRS-80 Model III.

On top of that, the sophisticated Telewriter full-screen editor is so simple to use, it makes writing fun. With single-letter mnemonic commands, and menu-driven I/O and formatting, Telewriter surpasses all others for user friendliness and pure power.

Telewriter's chain printing feature means that the size of your text is never limited by the amount of memory you have, and Telewriter's advanced cassette handler gives you a powerful word processor without the major additional cost of a disk.

*...one of the best programs for the Color Computer I have seen...*

— Color Computer News, Jan. 1982

### TELEWRITER-64

But now we've added more power to Telewriter. Not just bells and whistles, but major features that give you total control over your writing. We call this new supercharged version Telewriter-64. For two reasons.

### 64K COMPATIBLE

Telewriter-64 runs fully in any Color Computer — 16K, 32K, or 64K, with or without Extended Basic, with disk or cassette or both. It automatically configures itself to take optimum advantage of all available memory. That means that when you upgrade your memory, the Telewriter-64 text buffer grows accordingly. In a 64K cassette based system, for example, you get about 40K of memory to store text. So you don't need disk or FLEX to put all your 64K to work immediately.

### 64 COLUMNS (AND 85!)

Besides the original 51 column screen, Telewriter-64 now gives you 2 additional high-density displays: 64 × 24 and 85 × 24! Both high density modes provide all the standard Telewriter editing capabilities, and you can switch instantly to any of the 3 formats with a single control key command. The 51 × 24 display is clear and crisp on the screen. The two high density modes are more crowded and less easily readable, but they are perfect for showing you the exact layout of your printed page, *all on the screen at one time*. Compare this with cumbersome "windows" that show you only fragments at a time and don't even allow editing.

### RIGHT JUSTIFICATION & HYPHENATION

One outstanding advantage of the full-width screen display is that you can now set the screen width to match the width of your printed page, so that "what you see is what you get." This makes exact alignment of columns possible and it makes hyphenation simple. Since short lines are the reason for the large spaces often found in standard right justified text, and since hyphenation is the most effective way to eliminate short lines, Telewriter-64 can now promise you some of the best looking right justification you can get on the Color Computer.

### FEATURES & SPECIFICATIONS:

**Printing and formatting:** Drives any printer (LPV11/VIII, DMP-100/200, Epson, Okidata, Centronics, NEC, C. Itoh, Smith-Corona, Terminus, etc).

Embedded control codes give full dynamic access to intelligent printer features like: underlining, subscript, superscript, variable font and type size, dot-graphics, etc.

Dynamic (embedded) format controls for: top, bottom, and left margins; line length, lines per page, line spacing, new page, change page numbering, conditional new page, enable/disable justification.

Menu-driven control of these parameters, as well as: pause at page bottom, page numbering, baud rate (so you can run your printer at top speed), and Epson font. "Typewriter" feature sends typed lines directly to your printer, and Direct mode sends control codes right from the keyboard. Special Epson driver simplifies use with MX-80.

Supports single and multi-line headers and automatic centering. Print or save all or any section of the text buffer. Chain print any number of files from cassette or disk.

**File and I/O Features:** ASCII format files — create and edit BASIC, Assembly, Pascal, and C programs, Smart Terminal files (for uploading or downloading), even text files from other word processors. Compatible with spelling checkers (like Spell 'n Fix).

Cassette verify command for sure saves. Cassette auto-retry means you type a load command only once no matter where you are in the tape.

Read in, save, partial save, and append files with disk and/or cassette. For disk: print directory with free space to screen or printer, kill and rename files, set default drive. Easily customized to the number of drives in the system.

**Editing features:** Fast, full-screen editor with wordwrap, block copy, block move, block delete, line delete, global search and replace (or delete), wild card search, fast auto-repeat cursor, fast scrolling, cursor up, down, right, left, begin line, end line, top of text, bottom of text; page forward, page backward, align text, tabs, choice of buff or green background, complete error protection, line counter, word counter, space left, current file name, default drive in effect, set line length on screen.

Insert or delete text anywhere on the screen without changing "modes." This fast "free-form" editor provides maximum ease of use. Everything you do appears immediately on the screen in front of you. Commands require only a single key or a single key plus CLEAR.

*...truly a state of the art word processor...  
outstanding in every respect.*

— The RAINBOW, Jan. 1982

### PROFESSIONAL WORD PROCESSING

You can no longer afford to be without the power and efficiency word processing brings to everything you write. The TRS-80 Color Computer is the lowest priced micro with the capability for serious word processing. And only Telewriter-64 fully unleashes that capability.

Telewriter-64 costs \$49.95 on cassette, \$59.95 on disk, and comes complete with over 70 pages of well-written documentation. (The step-by-step tutorial will have your writing with Telewriter-64 in a matter of minutes.)

To order, send check or money order to:

Cognitech  
704 Nob Street  
Del Mar, CA 92014

Or check your local software store. If you have questions, or would like to order by Visa or Mastercard, call us at (619) 755-1258 (weekdays, 8AM-4PM PST). Dealer inquiries invited.

(Add \$2 for shipping. Californians add 6% state tax. Allow 2 weeks for personal checks. Send self-addressed stamped envelope for Telewriter reviews from CCN, RAINBOW, 80-Micro, 80-U.S. Telewriter owners: send SASE or call for information on upgrading to Telewriter-64. Telewriter-compatible spelling checker (Spell 'n Fix) and Smart Terminal program (Colorcom/E) also available. Call or write for more information.)

Apple II is a trademark of Apple Computer, Inc.; Atari is a trademark of Atari, Inc.; TRS-80 is a trademark of Tandy Corp; MX-80 is a trademark of Epson America, Inc.



# COLOR CONNECTION SOFTWARE

1060 Buddlea Dr., Sandy, Utah 84070 (801) 571-5023



## ATTENTION!!

Watch for next month's ad to see some exciting new products from COLOR CONNECTION SOFTWARE, including our first strategic arcade game!!

### COLOR DESIGNER



The ultimate Hi-Res Graphics Processor!!! Great for doodling, sketching, and most of all, creating entire graphics screens. Options include: 8 key cursor control with key repeat. Draw command that follows your cursor. FILL command that "PAINTS" the screen with more than 1000 different color/texture combinations, and much much more!!

16/32K cas \$26.95 disk \$28.95.

### QUIZ ALL



A versatile quiz program. Has study and test formats and allows printing of quiz. Even includes an option for the computer to generate multiple choice answers!

cas \$18.95 disk \$20.95

### COMPU SCRIBE B.S.A.

Got a headache keeping track of merit badges, rank advancements, etc. Compu Scribe keeps tabs on the whole troop and creates printouts by scout, by rank, or alphabetically. Requires a printer with 132 character mode.

Available on disk only - \$26.95.

### OKI DUMP

Eight bit screen dump from CoCo to an Okidata printer without dot addressable graphics! Includes hints on printing pictures of game screens, etc. ("The King" by Tom Mix, is the example) a steal at

16K cas \$8.95 16K disk \$10.95

Call or write for our free newsletter.



It's not just puppy love  
between us and our  
CoCo!



All cassette orders include disk version on cassette with instructions to transfer to disk. Unless otherwise specified, programs require 16K extended for cassette or 32K extended for disk. Add \$2.00 shipping and handling. Utah residents add 5% sales tax. Orders paid by personal check allow 1-2 weeks; all others shipped within 48 hours. No COD.

To order, call 24 hours a day or write  
COLOR CONNECTION SOFTWARE  
1060 Buddlea Drive, Sandy, Utah 84070



For information:



Call Weekdays between 6:30 pm and 10 pm MST  
(801) 571-5023

## Our Adventure Issue . . .

## Basketball to Image Processing . . .

## And, Introducing Rainbow Tech . . .

Yes, it's Adventure Contest time again and we not only have plenty of prizes for our Second Annual *Rainbow Adventure Contest*, but we also have several tutorials to get you started and some sample programs for you to learn from — including *Karrak*, a special four-part Adventure written by one of last year's top contest winners, Gregory Clark. The contest deadline for entries is May 1, 1984, and we'll award prizes in all sorts of categories so, even if you're a novice Adventurer, you have plenty of time to develop an entry.

Check out Captain 80's column for his "Adventuring in Style" commentary, and also read Liddil's tutorial on how to create a winning Adventure. Then, Eric Tilenius will provide an excellent short course in Adventure programming as he walks you through the creation of his *MiniAdventure*. For still more, head for the jungle in search of King Merro's crown in Jeff Craig's Adventure. And, when you begin *Karrak*, take my advice: Don't mess with the turtle.

Back issues of *the Rainbow* have many other Adventures and Adventure tutorials if you want to learn more before you try your hand and, yes, *The Rainbow Book of Adventures* is a reality, 112 pages of winning programs from last year's contest. It's \$7.95 and, if you can't find it at your computer store, call or write us — and ask about the *Rainbow Adventure Tape* (\$8), too.

Adventure and more. How about golf? Mike Knolhoff offers us an invitation to "The CoCo Open" in one of several games in this issue. On the more serious side, Dr. Bob Tyson, winner of our recent simulation contest, delves into "image processing," a technique used to enhance pictures sent back by space probes.

Both the game and the statistical sides of basketball come into play in this issue as Gary L. Carter offers a sports simulation and Dick White gives us a computer program to keep up with all the game stats from your favorite teams.

Making its debut this month is "School is in the Heart of A Child," by longtime *Rainbow* columnist Bob Albrecht and his new co-author Fran Saito. We welcome this series for the parents of very young children with the expectation that it will be as big a success as Bob's continuing series, the "GameMaster's Apprentice."

Also new this month is *Rainbow Check Plus*, by H. Allen Curtis. Allen offers us a markedly improved version of our familiar *Rainbow Check* program begun in January 1983. This month, values for both our old checksum program and Allen's new one appear in the "checkboxes" at the beginning of each listing, but next month we will begin using this new version exclusively.

Still another addition is *RainbowTech*, a special section for the more technically minded. While it is by no means forbidden territory for the beginner, we are putting some of our more advanced features in this portion of the magazine. Dale Puckett's "KISSable OS-9" will be a regular *RainbowTech* column. And *Rainbow* Technical Editor Dan Downard — we call him Dan Landers around these parts — will answer your technical questions in his new monthly Q & A feature, "Downloads."

Joining us this month and rounding out the faculty of *RainbowTech* are two CoCo community celebrities, Frank Hogg and Paul Searby. Frank will be writing about advanced operating systems, including OS-9, FLEX and 64K topics while Paul launches a regular feature on the design and development of application software for the CoCo.

No, we aren't offering advanced degrees from *RainbowTech*, but we do think there is much that can be learned by reading the *Rainbow*, and the tuition is very reasonable: For just \$28, you get a full year's worth of educational material at a rate of more than a dozen pages a day. So, if your name's not yet on the roster, why not enroll and keep the Adventure going all year 'round.

-- Jim Reed



# FIRE COPTER

WITH  
3-DIMENSIONAL  
GRAPHICS



## NOW

BY DALE LEAR

Down there — below and to the right — tongues of fire play across the face of a skyscraper like living things. Inside the copter, runaway temperatures nearly rip the consciousness from your heat-punished body, momentarily throwing you off course. BUT panic taps a hidden reservoir of strength, and with an adroit push on the throttle, your FIRE COPTER continues to knife through the swirling plume of smoke, carrying its lifesaving water jets directly into the flames. FIRE COPTER (a joystick controlled and accommodates one or two players). Ready for three-dimensional realism? Then you're ready for FIRE COPTER — the hot new arcade game from Adventure International!

Color Computer IIK Cassette

\$24.95

**ai** Adventure  
INTERNATIONAL

A SUBSIDIARY OF SCOTT ADAMS, INC.  
BOX 3435 • LONGWOOD, FL 32750 • (305) 862-0917

To order, ask your local dealer. If he does not have the program, then call 1-800-327-7172 (orders only please) or write for our free catalog. DEALER INQUIRIES ARE INVITED!



# FOR YOUR COLOR COMPUTER

# SUPER PRO KEYBOARD



- Only \$69.95
- Original key layout.
- No special software required.
- Fast, simple installation—no soldering.
- Individually boxed with full instructions.
- Professional, low profile, finished appearance.
- U.S. made—high quality, quad gold contacts.
- Smooth "Touch Typist" feel—no sagging.

#### **Rainbow, April '83**

A fine piece of hardware from Mark Data Products... It is super and it is professional too... If you are searching for a replacement keyboard, it is an excellent buy...

#### **Hot CoCo, August '83**

Like putting leather upholstery in your Volkswagen... Very impressed with the appearance and performance... Could easily pass as original equipment... Installation is very simple...

#### **Color Computer Magazine, June '83**

The installation procedure is well detailed and quite simple... Has a professional feel, reacts well to the touch... has held up to some purposeful pounding...

#### **Color Computer News, June '83**

Mark Data Products is well known to us "longtimers"... Every bit as finished as if Tandy had done it... The Mark Data Super-Pro is your best buy... The one that is in my CoCo to stay...

## **Great Computer Software Also**

- Adventure Games
- Arcade Games and Utility Software



**Mark Data Products**

24001 ALICIA PKWY., NO. 207 • MISSION VIEJO, CA 92691 • (714) 768-1551

All Orders: Please add \$2.00 shipping and handling in the continental U.S. All others, add air shipping and \$3.00 handling. California residents add 6% sales tax. Foreign orders please remit U.S. funds. Software authors—contact us for exciting program marketing details.

# SUPER SCREEN



- A big 51 character by 24 line screen.
- Full upper and lower case characters.
- Easily combine text with hi-res graphics.
- PRINT @ is completely functional on the big screen.
- The powerful ON ERROR GOTO is fully implemented.
- Auto-key repeat for greater keyboard convenience.
- Control codes for additional functions.
- Works with 16K, 32K or 64K computers.
- Available on disc or cassette.
- Works with extended and/or disc BASIC.

## 51 CHARACTERS BY 24 LINE DISPLAY

Super Screen is a powerful, machine language program that significantly upgrades the performance and usefulness of 16K or greater. Extended and Disc Basic Color Computers. The standard Color Computer display screen is totally inadequate for serious, personal or business applications so Super Screen replaces it with a brand new, 51 character wide by 24 line screen including full upper and lower case characters. Instead of a confusing checkerboard appearance, you now have true lower case letters along with a screen that is capable of displaying 1224 characters. The difference is startling! Your computer takes on new dimensions and can easily handle lines of text that were simply too long and complex to display on the old screen.

## COMBINE TEXT WITH HI-RES GRAPHICS

You can now write truly professional looking programs that combine text with hi-res graphics. Super Screen allows you to create graphics displays with the Basic LINE, DRAW and CIRCLE statements and then notate the graphics with descriptive text. You can even use PRINT @ if you wish for greater programming convenience. Super Screen's versatility will amaze you.

## PRINT @ IS FULLY IMPLEMENTED

The PRINT @ statement is a valuable asset to the programmer when formatting text on the screen. The standard Color Computer will report an error if you specify a location higher than 511 but Super Screen allows locations all the way to 1223! You get a big screen and a powerful formatting tool as well. Of course, Super Screen also supports the CLS command allowing you to clear the big screen using standard Basic syntax.

## ON ERROR GOTO

That's right! Super Screen gives you a full implementation of ON ERROR GOTO including the ERR and ERL functions. Now you can trap errors and take corrective action to prevent crashed programs and lost data using the same standard syntax as other computers. The ON ERROR GOTO capability overcomes a serious deficiency of Color Computer Basic and greatly improves your capability to handle sophisticated tasks. All well written, "user friendly" programs use error trapping techniques and yours can too! Now that's power!

## AUTO KEY REPEAT

No more frustration as you edit a long line in your Basic program: just hold the space bar down and automatically step to the desired position in the line. Need a line of asterisks? Hold the key down and auto repeat will give them to you. Those of you who spend many hours at your keyboard will appreciate this outstanding addition to Super Screen's long list of impressive capabilities.

## CONTROL CODES FOR ADDITIONAL FUNCTIONS

Super Screen recognizes several special control code characters that allow selection of block or underline, solid or blinking cursor and other functions. You can "Home Up" the cursor or you may erase from the cursor to the end of a line or to the end of the screen just like many other computers. These special codes give you an extra dimension of versatility and convenience that put Super Screen in a class by itself.

## AND MORE GOOD NEWS...

Super Screen comes with complete, well detailed instructions and is available on cassette or disc. It adjusts automatically to any 16K or greater, Extended or Disc Basic Color Computer or TDP-100 and uses only 2K of memory in addition to the screen memory reserved during power up. Guaranteed to be the most frequently used program in your software library... once you use it, you won't be without it! Super Screen's low price will really please you: only \$29.95 on cassette or \$32.95 on disc!

## 64K Memory Expansion Kit

All parts and complete instructions  
**\$64.95**



# Mark Data Products

24001 ALICIA PKWY., NO. 207 • MISSION VIEJO, CA 92691 • (714) 768-1551

All Orders: Please add \$2.00 shipping and handling in the continental U.S. All others add air shipping and \$3.00 handling. California residents add 6% sales tax. Foreign orders please remit U.S. funds. Software authors—Contact us for exciting program marketing details. We accept MasterCard and VISA. Distributed in Canada by Kelly Software.

## ACCOUNTING SYSTEM

The Mark Data Products accounting system is ideal for the small businessman needing a fast, efficient means to process income and expenses, prepare detailed reports and maintain most of the information required at tax time. The system is a family of programs which operate by means of a "menu" selection scheme. When the operator selects a task to perform, the computer loads a program designed to handle that task from the system disc. The system disc contains all of the programs required to create, update and maintain data files and prepare the necessary accounting reports including a transaction journal, a P&L or income report, an interim or trial balance and a balance sheet.

Up to 255 separate accounts may be defined and a single disc system can hold over 1,400 transactions. This system automatically enhances the monitor screen to a 51 character by 24 line display. 32K of memory is required along with an 80-column printer and one or more disc drives.

The MDP system:

- Is accurate, user friendly and simple to use.
- Is easy to customize for specific user requirements.
- Immediately updates the chart of accounts.
- Provides an audit trail.
- Includes end of period procedures.
- Is capable of future expandability.

This accounting software equals or exceeds higher priced packages for other computers and includes a detailed operating manual.

Requires 32K and a Single Disc Drive  
PRICE: \$99.95

## ORDER ENTRY SYSTEM

The Mark Data Products sales order processing system provides a fast, efficient means to enter orders, print shipping papers and invoices, prepare sales reports, and monitor receivables. The system automatically enhances the monitor screen to a 51 character by 24 line display. 32K of memory is required along with an 80-column printer, and one or more disc drives.

The MDP order entry system is a family of programs which operate interactively by means of a "menu" selection scheme. Up to 900 products may be defined and a single disc system can hold over 600 transactions. When the operator selects a task to be performed, the computer loads a program designed to handle that task from the system disc. The system disc contains all of the programs required to create, update and maintain data files and prepare the necessary paperwork including shipping and invoice forms, daily sales reports, a monthly (or other period) sales report and a receivables report.

The MDP system:

- Is accurate, user friendly and simple to use.
- Is easy to customize for specific user requirements.
- Produces a traceable invoice.
- Handles receivables as well as closed orders.
- Is capable of future expandability.

This order entry software equals or exceeds higher priced packages for other computers and includes a detailed operating manual.

Requires 32K and a Single Disc Drive  
PRICE: \$99.95

## THE MARK DATA PRODUCTS SUPER PRO KEYBOARD...

The most popular replacement keyboard for your CoCo

- Original key layout.
- No special software required.
- Fast, simple installation—no soldering.
- Individually boxed with full instructions.
- Professional, low profile, finished appearance.
- U.S. made—high quality, quad gold contacts.
- Smooth "Touch Type" feel—no sagging.

Only \$69.95

## IMPORTANT NEW BOOKS

"Your Color Computer" by Doug Mosher. Over 300 pages of detailed information—A CoCo encyclopedia. \$12.95.

"Programming the 6809" by Rodney Zaks and William Labiak. One of the best 6809 machine language texts available—required reference material. \$15.95.

## WE STOCK SOFTLAW PRODUCTS

The VIP WRITER Text Processor is rated tops by Rainbow, Hot CoCo and Color Computer Magazine. After evaluation we rate it tops too. Disc \$59.95.

# COLOR COMPUTER SOFTWARE



GAME PRICES  
Cassettes \$24.95  
Disc \$27.95

SUPER SCREEN  
Cassette \$29.95  
Disc \$32.95

- SPACE RAIDERS**—A sensational rendition of the arcade classic. No collection is complete without this invaders type game. Great sounds and tense action. We think it's the best. **Cassette—\$24.95 / Disc \$27.95.**
- CAVE HUNTER**—Maneuver your way to the bottom of a spooky old cave to retrieve the treasures. It's fun but not easy! Passages lead in all directions and angry cave creatures pursue you relentlessly. A fast placed arcade game. **Cassette—\$24.95 / Disc \$27.95.**
- ASTRO BLAST**—Wave after wave of alien attackers—each one different and unique. A great space "shoot-em-up" with hi-res graphics, lots of color and dramatic sound effects. A continuing best seller. **Cassette—\$24.95 / Disc \$27.95.**
- HAYWIRE**—This challenging combination of angry robots and the evil menace will provide many hours of fun and excitement. Haywire is the best Color Computer version of the Berzerk arcade game you can get. **Cassette—\$24.95 / Disc \$27.95.**
- BLACK SANCTUM**—If you enjoy suspense, you'll love this one. Encounter the forces of black magic as you roam around an old 18th century monastery. Watch out for the black hooded figures! **Cassette—\$19.95.**
- CALIXTO ISLAND**—A challenging puzzle with an occasional twist of humor. You'll visit a secret laboratory, a Mayan pyramid and you'll meet crazy Trader Jack who adds to the fun. **Cassette—\$19.95.**



Mark Data Products

24001 ALICIA PKWY., NO. 207 • MISSION VIEJO, CA 92691 • (714) 768-1551

All Orders: Please add \$2.00 shipping and handling in the continental U.S. All others, add air shipping and \$3.00 handling. California residents add 6% sales tax. Foreign orders please remit U.S. funds. Software authors—contact us for exciting program marketing details.

# RAINBOW CHECK PLUS FOR THE COCO AND THE MC-10

By H. Allen Curtis

Since the January 1983 issue, *the Rainbow* has provided you with a program, *Rainbow Check*, to ease the labor of your typing its BASIC programs. *Rainbow Check* was the means of determining a class of typing errors that would change the byte count of a specified number of lines of BASIC programming.

There were some important classes of typing errors that *Rainbow Check* could not detect:

- 1) It could not distinguish between incorrect and correct line numbers, such as 300 CLS from an intended 390 CLS.
- 2) It could not distinguish between incorrect and correct variables, such as F from an intended E.
- 3) It could not distinguish between incorrect and correct command words, such as SIN from an intended SGN.

For your further convenience a new, more comprehensive checking program, called *Rainbow Check Plus*, has been developed. It will detect errors of the classes 1), 2) and 3) as well as the class detected by *Rainbow Check*. There are two

*(H. Allen Curtis, who earned degrees from the College of William and Mary, M.I.T., and Harvard, recently won an award for meritorious service from the IEEE Computer Society. He has had published a college reference book in the computer science field, as well as many papers and articles.)*

versions of *Rainbow Check Plus*—one for CoCo users and another for MC-10 users.

The BASIC interpreter puts every program into the following form: Every number initiating a line of BASIC programming is represented by two bytes—a most significant byte and a least significant byte. Every command word is represented by a token byte. In the case of CoCo some command words are represented by 2-byte tokens. Each character, other than those comprising command words, is represented by a single byte in ASCII code.

*Rainbow Check Plus* includes each of the aforementioned bytes in the calculation of checksums. In those calculations *Rainbow Check Plus* employs a number system in which the successor of 255 is 0.

When you erroneously type 300 CLS when 390 CLS was intended, *Rainbow Check Plus* uses the bytes 1 and 44, instead of the correct byte values 1 and 134, in calculating the checksum. The ensuing incorrect checksum indicates that a typing error has occurred.

Similarly, when F is mistakenly typed for E, the ASCII code 70 is used instead of the correct code 69 in checksum calculations.

If a typed character is part of a valid BASIC command word, the value of the token used by the BASIC interpreter to represent that word is associated with all the characters in the word. For example, the value associated with F, O and R

The world's largest  
manufacturer of software  
presents . . .

\*OS-9 is a registered trademark of Microware Inc. and  
also FLEX is a registered trademark of Technical Systems  
Consultants, Inc.

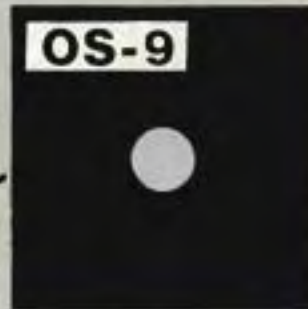
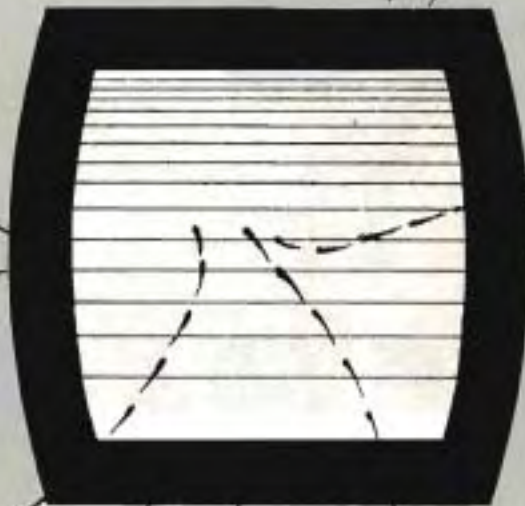

**-PAK**

**O-PAK**  
for OS-9

**Hi Res Screen &  
Utilities Package**

Use one of the available Hi-res  
character sets, or create your own! Mix  
graphics with text on a screen with  
unlimited flexibility. The utilities  
include the ability to copy files three  
ways, between FHL FLEX, RS OS-9 and  
Radio Shack DOS. For CoCo OS-9 - **\$34.95**

**INCLUDE \$3.50 SHIPPING & HANDLING**

**FHL** **FRANK  
HOGG  
LABORATORY**

THE REGENCY TOWER • SUITE 215 • 770 JAMES ST. • SYRACUSE, NY 13203  
PHONE (315)474-7856 • TELEX 646740

# LANGUAGES

## A/BASIC COMPILER for OS9 and FLEX

Produce fast, compact, ROMable object code from easy to write BASIC source code.

OS9 or FLEX Object only: **\$75.00** Available for CoCo

## DYNASOFT PASCAL for OS9 and FLEX

This remarkable Pascal Subset is a p-code implementation that only requires 12K of RAM!

OS9:	FLEX:		
Object only:	<b>\$69.95</b>	Object only:	<b>\$59.95</b>
With Source:	<b>\$99.95</b>	With Source:	<b>\$89.95</b>

Available for Color Computer

## NEW! DYNA-C for OS9 and FLEX

This new "C" subset runs circles around any others in its price class!

OS9:	FLEX:		
with Source:	<b>\$109.95</b>	with Source:	<b>\$99.95</b>

Available for Color Computer

## INTROL-C COMPILER for OS9 and FLEX

A complete, efficient, fast C compiler which includes a Macro Relocating Assembler/Linking Loader, Runtime Library, and Library Manager.

OS9 or FLEX Object only: **\$375.00**

Available for Color Computer

## COMPUTERWARE'S RANDOM BASIC

11 Digits of precision. Conforms closely to the ANSI standard.

OS9:	<b>\$195.00</b>
FLEX:	<b>\$100.00</b>
CoCo FLEX Version:	<b>\$ 75.00</b>

# APPLICATION SOFTWARE

## DYNASTAR SCREEN EDITOR /

### WORD PROCESSOR for OS9 or FLEX

This extremely powerful, menu-driven Word Processing system is composed of Dynastar, the Text Generator and Dynaform, the Text Formatter/Mail Merge program.

DYNASTAR:		Color Computer Versions:
for OS9 or FLEX:	<b>\$149.95</b>	\$49.95
DYNAPFORM:		
for OS9 or FLEX:	<b>\$149.95</b>	\$49.95
Purchased together:	<b>\$275.00</b>	\$99.90

## DYNASPELL Spelling Checker

Dynaspell is the most versatile 68XX Spelling Checker available. Use it with Dynastar or Stylograph for a complete word processing system. Now with new LOOKUP command!

FLEX or OS-9	\$199.00
CoCo Version	\$ 59.95

## DO - JOB CONTROL LANGUAGE for OS9

This easy to use, "BASIC-like" Job Control Language is great for Batch processing.

CoCo OS9 version: **\$49.00** General OS9 version: **\$99.00**

## RMS RECORD MANAGEMENT SYSTEM

RMS is a complete Database Management package made up of five machine language programs. One of the most powerful and versatile on the market!

OS9 Object only: **\$250** FLEX Object only: **\$300**

# SOFTWARE DEVELOPMENT TOOLS

## OSM - A 6809 MACRO ASSEMBLER for OS9 and FLEX

This is an extended Macro Assembler with conditional directives which will generate OS9 or FLEX binary files.

OS9 or FLEX Object only: **\$99.00**

Available for Color Computer

## CRASMB - MACRO CROSS ASSEMBLER FOR OS9 and FLEX

Use the Macro Cross-Assembler and any of the following CPU Personality Modules (CPM's) to assemble that CPU's Source code into OS9, FLEX, Motorola S1-S9 or INTEL-HEX formatted Object code files. Available CPM's: Motorola 6800-2-8, 6801-3, 6805, 6809, Mostek 6502, RCA 1802, INTEL 8080-5, ZILOG Z-80.

OS9 or FLEX:	
CRASMB Object only:	<b>\$200.00</b>
CPM's Object only:	<b>\$ 35.00 each</b>
CPM's with Source:	<b>\$ 70.00 each</b>

Available for Color Computer

\* SPECIAL \* Purchase CRASMB with all modules (Source included) for **\$499.00**

## CROSS ASSEMBLER MACROS

Use the appropriate MACRO with a standard Assembler to assemble Source code into Object code for any of the following CPU's: 6800/1, 6805, 6502, 8080/5, and Z-80.

Object only MACROS:	
OS9:	<b>\$55.00 each or 3/\$110.00</b>
FLEX:	<b>\$50.00 each or 3/\$100.00</b>

Available for Color Computer

## SUPER SLEUTH

Examine and modify or disassemble binary program files into source code format. Object code for 6800, 01, 02, 03, 05, 08, 09, or 6502 may be processed.

Object only:		With Source:	
CoCo OS9	<b>\$49.95</b>	OS9	<b>\$ 99.00</b>
CoCo FLEX	<b>\$50.00</b>	FLEX	<b>\$ 99.00</b>
RS DOS	<b>\$49.00</b>	UniFLEX	<b>\$100.00</b>

## Z-80 SUPER SLEUTH

Functions the same as the above SLEUTH though this analyzes Z-80, 8080, 8085 object programs.

Same prices as Super Sleuth. Not available for RS DOS.

## DYNAMITE +

Easy to use disassembler complete with cross-reference generator, and label files maintained in text form only.

OS9:	FLEX:		
Object only:	<b>\$150.00</b>	Object only:	<b>\$100.00</b>

Available for Color Computer

## 6800 - 6809 and 6809 PIC/PID TRANSLATORS

Convert 6800/1 assembly language programs to 6809 assembly language programs, and 6809 Assembly code to position-independent code and data.

OS9	Object only:	<b>\$75.00</b>
FLEX	Object only:	<b>\$50.00</b>
UniFLEX	Object only:	<b>\$75.00</b>

Available for Color Computer

## EDIT / ASSEMBLE for OS9

Editor with "Screen-like" line editing capabilities and a Conditional Macro Assembler. Both much more powerful than those inclusive with the Color Computer.

CoCo OS9 Object only: **\$69.95**



of FOR would be 128, the token representing FOR in both CoCo and MC-10.

Suppose that you mistakenly typed SIN when SGN was intended. In CoCo, the token for SIN consists of two bytes whose values are 255 and 132. These values would be employed in checksum calculations instead of the correct ones, 255 and 128, for SGN. In MC-10, the SIN token, 185, would be used instead of the correct value, 177.

Thus, it is seen that for every error you make in typing a BASIC program, an incorrect byte value is employed in *the Rainbow Check Plus* checksum calculations.

The Listings 1 and 2 show CoCo and MC-10 versions, respectively, of *Rainbow Check Plus*. It is part BASIC and part machine language. The BASIC part generates the machine language part which does the actual checking. The BASIC portion stores the machine language program at the 78 and 91 highest RAM addresses of CoCo and MC-10, respectively. Regardless of whether your CoCo is a 4K, 16K or 32K RAM system, the machine language program will be stored in high RAM. The former *Rainbow Check* did not support 4K CoCo systems.

You use *Rainbow Check Plus* as follows: Suppose you wish to type from *the Rainbow* a BASIC program having a *Rainbow Check Plus* box such as:

```
765....229
1600.... 37
END....184
```

With the machine language program stored in high RAM as a result of running *Rainbow Check Plus* (do not run the BASIC part more than once), type *NEW* and press [ENTER]. Then type all lines up to and including Line 765 of *the Rainbow* program. Next, press the down-arrow key of your computer. A decimal checksum will immediately be printed on the screen. It should be 229. If it is not, you have made a typing error. When you have correctly typed in all lines

through 765, type all lines from 765 through 1600. Again press the down-arrow to display the next checksum. It should be 37, if your typing was correct. When you have all lines through 1600 correctly typed, finish typing the program. Then, pressing the down-arrow should display the number 184 if your typing has been perfect.

It should be pointed out that your typing accuracy can be further facilitated if you take advantage of the following fact: *the Rainbow* duplicates your computer's 32-character per screen line format in its presentation of BASIC programs. This makes it easy to discover whether or not your typing is properly spaced.

#### Listing 1 (CoCo):

```
10 CLS: X=256*PEEK(35)+178
20 CLEAR 25, X-1
30 X=256*PEEK(35)+178
40 FOR Z=X TO X+77
50 READ Y: W=W+Y: PRINT Z, Y; W
60 POKE Z, Y: NEXT
70 IF W=7985 THEN 80 ELSE PRINT "DATA
ERROR": STOP
80 EXEC X: END
90 DATA 182, 1, 106, 167, 140, 60, 134
100 DATA 126, 183, 1, 106, 190, 1, 107
110 DATA 175, 140, 50, 48, 140, 4, 191
120 DATA 1, 107, 57, 129, 10, 38, 38
130 DATA 52, 22, 79, 158, 25, 230, 129
140 DATA 39, 12, 171, 128, 171, 128
150 DATA 230, 132, 38, 250, 48, 1, 32
160 DATA 240, 183, 2, 222, 48, 140, 14
170 DATA 159, 166, 166, 132, 28, 254
180 DATA 189, 173, 198, 53, 22, 126, 0
190 DATA 0, 135, 255, 134, 40, 55
200 DATA 51, 52, 41, 0
```

#### Listing 2 (MC-10):

```
10 CLS: X=256*PEEK(16976)+165
20 CLEAR 25, X-1
30 X=256*PEEK(16976)+165
40 FOR Z=X TO X+90
50 READ Y: W=W+Y: PRINT Z, Y; W
60 POKE Z, Y: NEXT
70 IF W<>8995 THEN PRINT "DATA ERRO
R": STOP
80 EXEC X: END
90 DATA 182, 66, 133, 167, 78, 182
100 DATA 66, 134, 167, 79, 182, 66
110 DATA 135, 167, 80, 134, 126, 183
120 DATA 66, 133, 198, 27, 58, 255, 66
130 DATA 134, 57, 129, 10, 38, 47, 60
140 DATA 54, 55, 79, 222, 147, 230, 0
150 DATA 39, 15, 8, 8, 171, 0, 8, 171, 0
160 DATA 8, 230, 0, 38, 249, 8, 32, 237
170 DATA 183, 66, 192, 252, 66, 134
180 DATA 195, 0, 54, 55, 54, 56, 223
190 DATA 244, 166, 0, 189, 229, 73, 51
200 DATA 50, 56, 126, 0, 0, 134, 188
210 DATA 40, 49, 55, 48, 56, 56, 41, 0
```

Hint . . .

## RS-232 Baud Rates

These poke values for the CoCo will create the 16 most commonly used Baud rates. They are as follows:

Baud Rate	POKE 149	POKE 150
50	4	88
75	2	227
110	1	246
134.5	1	153
150	1	110
300		180
600		87
1200		40
1800		25
2000		23
2400		18
3600		10
4800		7
7200		3
9600		1

To achieve 19200 Baud, one must use the pokes for 9600 Baud and then use the bold poke (65497,0) to double the CoCo's speed. (Use *POKE 65496,0* to restore normal speed.)



# Five Easy Ways To Clean Up Your Finances.



actual screen display \*Indicates function being shown

1  
Chart of Accounts  
\*Checkbook Maintenance  
Check Search  
Prints Checks

2  
\*Detail Budget Analysis  
Summary Budget  
Analysis  
Income/Expense  
Statements  
Net Worth Statement

3  
Appointments Calendar  
Payments Calendar  
\*Color Chart Package  
Mailing List

4  
\*Spreadsheet  
Compatible with  
Finance 1, 2 and 5

5  
\*Income Tax  
Prints forms  
Most schedules  
Uses Finance 1, 2 and 4

## the Complete Personal Accountant™



Whether you're cleaning up at home or around the office, there's NOW a COMPLETE line of money management software that will attend to all the details, while letting you see the whole financial picture. The *Complete Personal Accountant's* exclusive combination of easy to use programs give the wise investor a quick and dependable way to control finances and plan for the future.

FINANCE 1 gets you organized with a standard chart of accounts adaptable to any situation. The Checkbook Maintenance program with *full screen editing* and special 'Help' commands let you find any check by any field. You can flag tax deductibles, reconcile your bank statement, print checks and more.

FINANCE 2 tells you where your money is, where it's going and where it's coming from. The Detail and Summary Budget programs show exactly where you're spending your money. The Income/Expense and Net Worth programs provide professional-looking statements that can be printed with any 80 column printer.

FINANCE 3 separates the CPA from the competition. No other finance package for the home or small business gives you Ap-

pointments and Payments Calendars for scheduling your time and money. Few packages offer the ability to chart each account in color. And only the CPA includes a mailing list with a 1200 name capacity\*. All reports are printable with an 80 column printer.

FINANCE 4 lets you determine the "what ifs" of your financial future. With this easy to learn spreadsheet you'll spend more time making decisions and less time crunching numbers.

FINANCE 5, The Tax Handler™, uses your files from Finance 1, 2 and 4 to complete your taxes in a fraction of the normal time.

The Complete Personal Accountant™ line of money management software is simply the most comprehensive, easy to use financial software available anywhere.



	Disk	Cassette
Finance 1	39.95	36.95
Finance 2	29.95	26.95
Finance 3	29.95	26.95
Finance 4	29.95	26.95
Finance 5	59.95	54.95

SAVE when you purchase Finance 1, 2 and 3 as a set

79.95 74.95

Available for Atari 400/800/1200\*, Commodore 64\*, IBM PC\*, TRS 80 Color™ and Vic 20\*

Prices subject to change without notice. Add \$3.00 for postage and handling.

Ask your local dealer to see a running demo or call 1-800-334-SOFT to order direct.

\*Varies according to computer.

programmer's institute

a division of

p.o. box 3470, department rr, chapel hill, north carolina 27514



# THE CROWN



# OF MERRO



By Jeff Craig

I was first introduced to Adventures on the TRS-80 Model III and it wasn't until I got a CoCo, a year later, that I actually started playing Adventures. At first it was pretty confusing, but after awhile I got the hang of it and I started solving them. I thought then and I still think that Adventures are great. I'd even go as far as to say that I like Adventures better than most arcade-type games.

One day I sat down with my computer and began to make a two-word Adventure. I soon found out that it wasn't as easy as I thought! I wanted to find a way of identifying the words entered without using a whole bunch of *LEFTS* and *RIGHTS* garble. After a few days of searching and thinking, I found the long-lost *INSTR* command. With some help from my dad, who is also a CoCo enthusiast, I created a faster and shorter subroutine than other Adventures. In this program, the *INSTR* command compares the words entered with those in the program's vocabulary and converts the words into numbers. If the word is not in the vocabulary, then the number will come out as 0. Another thing that I think is pretty nifty is my scrolling routine. It's not really part of the the Adventure, but I think it adds spice. To scroll the phrase across the screen, I used *FOR* loops and *LEFTS*, *RIGHTS*. You can change this subroutine and use it in different programs.

As in most Adventures, *Merro* has a main objective. Your mission is to find the ancient crown of King Merro, which is hidden somewhere in the Amazon jungle. Be careful, there are many hazards to face in the jungle!

This Adventure recognizes commands such as GET, LOOK, N to go north, and even GO as in GO RIVER. The vocabulary does not contain different words that mean the same thing, such as EXAMINE and LOOK, so if one word doesn't work, try another, I have not incorporated a save feature in this game because I didn't really find it necessary, but if you find otherwise, I am sorry. I don't have any hints for you because I don't want to make it any easier for you (hee hee).

This game takes almost all of my 16K so it is necessary to type in *POKE25,6:NEW* before you load it or finish typing it in. Also, it is necessary to unplug your disk drive when *RUNning*.

I hope you enjoy playing this game. If you require any assistance in solving it, please write: Jeff Craig, 2556 James Ave., Muskegon, Mich., 49442. Good luck!

*(Jeff Craig is a sophomore and honor student at Muskegon, Michigan's, Orchard View High School. He is interested in science fiction and role playing games. In the future, he hopes to attend the Air Force Academy and major in aviation or computer science.)*

**Rainbow  
Check  
Plus**

90	041F	80	920	1E5D	180
240	0A03	106	970	20A6	244
400	0D3D	247	1050	243C	217
450	0F5A	4	1110	26DB	35
560	12CB	155	1270	2953	203
670	158D	179	1390	2BAF	189
750	1876	89	1530	2ED6	217
830	1AED	111	END	2FF6	5

The listing:

```

1 * THE CROWN OF MERRO
2 * BY
3 * JEFF CRAIG
4 * (C) DEC. 1983
5 *
10 CLS4:PRINT@7,"THE CROWN OF ME
RRO";:SCREEN0,1
20 CLEAR100:DIMD(32,4),B(42),B$(
42),R$(17):R=1:P=3
30 FORY=1TO4:FORX=1TO32:READD(X,
Y):NEXTX,Y
40 DATA,1,,24,,,,,32,11,12,,,1
5,16,,2,19,,23,22,4,,5,,,,,10,,
3,,21,25,,,,30,,,,,13,,,2,,,20,
4,22,,,29,27,,10,,,2,19,,24,26,
,,,,,13,14,,,,,20,,,23,22,5,,,
,,,,,10,11,,18,2,22,,,,,29,30,,,1
5,,,,,,4,23,22,,5,,28,,27,,,
50 FORX=1TO38:READB(X):NEXTX
60 DATA100,100,100,2,,25,8,30,1
0,12,,28,1,29,3,20,4,5,25,26,26,
6,27,29,10,14,15,,17,,30,,11,,11
,16,16
70 FORX=1TO38:READB$(X):NEXTX
80 DATA SOME 'SUPER FLARE' MATCH
ES,SURVIVAL RATIONS,AN EMPTY CAN
TEEN,A PRIMITIVE WEAPON,A DELICI
OUS BANANA,AN * IVORY TUSK *,AN
OLD MAP,A THUUNOON EGG,A HUMAN L
IMB,A SHRUNKEN HEAD,A BRONZE TOR
CH,* MERRO'S CROWN *,A HACKSAW
90 DATATHE AMAZON RIVER,A RIVER
OF PIRANHA,MANY TREES,A HAIRY AP
E,AN ANCIENT FOUNTAIN,ELEPHANT S
KELETONS,A * LARGE RUBY *,MANY A
RMY ANTS,A BRANCHY TREE,A STURDY

```

VINE,AN OLD TREE,A TALL TREE,A  
GROUP OF CANNIBALS,A RUSTY GATE,  
A SACRIFICIAL ALTAR  
100 DATAA ROTTING SKULL,A DUSTY  
COFFIN,KING MERRO,A LOG OVER A  
RIVER,A LOG,AN ANCIENT STRUCTURE,  
A DARK CAVE,AN EVIL EXPLORER,THI  
CK WHITE WEBS,MANY BLACK WIDOW S  
PIDERS

```

110 FORX=1TO17:READR$(X):NEXTX
120 DATASTANDING ON A SHORE,ON A
PATH,EAST OF THE PATH,IN A SMAL
L CLEARING,IN A ELEPHANT GRAVEYA
RD,IN A BRANCHY TREE,,IN AN OLD
TREE,ON A LONG LOG,IN A SMALL VI
LLAGE,IN A CLEARING,IN A DISMAL
CAVE,IN A DAMP CAVE,IN A DREARY
ALCOVE

```

```

130 DATAIN A ERIE TEMPLE,IN A SP
OOKY CRYPT,IN MERRO'S TOMB

```

```

140 FW$="N E S W I GO
GET DROPSWINLOOKGIVEPUSHDRINFIL
LKILLCLIMCHOPSWIMEAT LIGHSAW BUR
NTURNOPENSAY QUIT"

```

```

150 SW$="MATCRATICANTAXE BANATUS
KMAP EGG LIMBHEADTORCCROWHACKTRE
EAFE FOUNFACENOSEWATEVINELG CAN
NSTRUGATETEMPALTASKULPASSWEBSSPI
DCOFFMERRORRECAVESKELRIVEANTSUB
YEXPLWEAPEYESMOUT"

```

```

160 CLS2:PRINT@1,"
"
```

```

170 PRINT@64," THIS IS A BASIC
TWO WORD ADVENTURE. USE COM
MANDS SUCH AS 'KILL APE' & 'DRIN
K WATER'. IF ONE COMMAND DOESN'
T WORK TRY ANOTHER! USE COMMA
NDS SUCH AS 'N' TO MOVE A DIRE
CTION AND 'I' TO TAKE INVENTORY.
"
```

```

180 PRINT:PRINT" I AM AN ENGLI
SH EXPLORER OUT TO FIND THE LOST
CROWN OF MERRO.WHEN MY BOAT STO
PPED, MY PARTNERKNOCKED ME OUT A
ND TOOK OFF, TAKING MOST OF M
Y EQUIPMENT. YOU MUST HELP ME FIN
D THE CROWN."

```

```

190 IFH<1THENK$="--* THE CROWN O
F MERRO *=- " :H=1:L$=""ELSEK$
="....BY JEFF CRAIG....
":H=0:L$=""

```

```

200 FORI=1TO30:L$=LEFT$(K$,I):PR
INT@31-I,L$::IFINKEY$=""THEN210E
LSE240

```

```

210 FORTD=1TO50:NEXTTD,1:FORI=29
TOOSTEP-1:L$=RIGHT$(L$,I):PRINT@
1,L$::IFINKEY$=""THEN220ELSEGOTO
240

```

```

220 FORTD=1TO50:NEXTTD,I:GOTO190
230 IFINKEY$=""THEN230

```

```

240 CLS3:PRINT"I AM ";
250 IFR>17THENPRINT"IN A VERY DE
NSE JUNGLE." ELSEPRINTR$(R);"."
260 PRINT"OBVIOUS EXITS:":GOSUB
1180
270 PRINT"I SEE...":GOSUB1230
280 PRINT"*";STRING$(30,"-");"*"
290 GOSUB1260:V=0:W=0
300 IFM$=""THENV=0:GOTO340
310 V=INSTR(1,FW$,M$):V=(V+3)/4:
IFV<1THENV=0
320 IFN$=""THENW=0:GOTO340
330 W=INSTR(1,SW$,N$):W=(W+3)/4:
IFW<1THENW=0
340 IFV=0THEN1310ELSEIFV=26THENC
LS:PRINT:PRINT:PRINT:GOTO1580
350 IFQ8>0 ANDZ1<1THENQ9=Q9+1:IF
Q9>3THEN1520
360 IFV<6 AND W=0THEN1320ELSEIFV
=25 ANDR<>17THENPRINT:PRINT"OK..
.NOTHING HAPPENS.":GOTO290
370 IFV=7 ANDW=12 ANDB(12)=R THE
NGOTO1130ELSEIFV=7 ANDW=12THEN14
70ELSEIFV=10 ANDW<>0 ANDW<14 AND
B(W)<>100 AND B(W)<>R THEN1470
380 IFV=10 ANDW=0THENGOTO240ELSE
IFV=10 ANDW=11 AND(B(11)=R OR B(
11)=100)ANDQ7<1THENPRINT:PRINT"THE
TORCH JUST LIT UP!":B$(11)="A
LIT TORCH":Q7=1:GOTO290ELSEIFV=
10 ANDW=11 ANDQ7>0THEN1410ELSEIF
V=10 ANDW=11THEN1420
390 IFV=10 ANDW=13 ANDB(13)=100T
HENPRINT:PRINT"IT LOOKS LIKE THE
ONE THAT WAS STOLEN FROM ME.":
GOTO180ELSEIFV=10 ANDW=13THEN142
0
400 IFV=16 ANDB(23)=100THENPRINT
:PRINT"I CAN'T...I'VE GOT THE VI
NE!":GOTO290
410 IFV=10 ANDW=38 ANDB(20)=100T
HENPRINT:PRINT"IT'S MADE OF GLAS
S":B$(20)="A GLASS RUBY":GOTO290
ELSEIFV=10 ANDW=38THEN1420ELSEIF
V=10 ANDW=8 ANDB(8)=100THENPRINT
:PRINT"IT'S YELLOW WITH BROWN SP
OTS.":GOTO290ELSEIFV=10 ANDW=8TH
EN1420
420 IFV=10 ANDW=7 ANDB(7)=100THE
NPRINT:PRINT"IT SAYS: GO DIRECTL
Y TO JAIL, DO NOT PASS GO, AND
DO NOT", "COLLECT $200.":GOTO290
ELSEIFV=10 ANDW=7THEN1420
430 IFV=10 ANDW=40 AND(B(4)=100
ORB(4)=R)THENPRINT:PRINT"IT'S VE
RY SIMILAR TO AN AXE.":B$(4)="A
VERY SHARP AXE":GOTO290ELSEIFV=1
0 ANDW=40THEN1470
440 IFV=7 ANDW=38 ANDB(20)=R THE
NP=P+1:IFP>3THEN1390ELSEIFV=7 AN

```

```

DW=38 ANDB(20)=R THENB(20)=100:P
RINT"OK.":IFB(12)=100THEN1130ELS
EGOTO290
450 IFW=40THENW=4
460 IFV=7 ANDW=38THEN1470
470 IFV=7 ANDN$="WATE"THENPRINT:
PRINT"TRY PUTTING IT IN SOMETHIN
G.":GOTO290ELSEIFV=7 ANDW=20 AND
B(23)=R THENP=P+1:IFP>3THEN1390E
LSEIFV=7 ANDW=20 ANDB(23)=R THEN
B(23)=100:PRINT"OK.":GOTO290
480 IFV=7 ANDW>13THEN1480
490 IFV=7 AND B(W)=R THENP=P+1:I
FW=5 THENQ3=1:GOTO1390ELSEIFP>3T
HEN1390ELSEB(W)=100:PRINT"OK.":G
OTO290
500 IFV=7 AND(W>13 AND W<>20)THE
N1450ELSEIFV=8 ANDW=20 AND B(23)
=100THENPRINT"OK.":B(23)=R:P=P-1
:GOTO290
510 IFV=8 ANDW=38 ANDB(20)=100TH
ENP=P-1:B(20)=R:GOTO290ELSEIFV=8
ANDW=38THEN1420
520 IFV=8 AND B(W)=100 THENP=P-1
:B(W)=R:PRINT"OK.":GOTO290ELSEIF
V=8THEN1420
530 IFV=20 AND W=1 AND B(1)=100
ANDR<>10THENPRINT:PRINT"OK...THE
MATCH LIGHTS AND FLARES BRIEFLY.
":GOTO290 ELSEIFV=20 AND W=1 AND

```

## OUR PROGRAMS AREN'T JUST FOR KIDS

EVERYONE LOVES OUR ENTERTAINMENT AND BUSINESS PROGRAMS

■ **GOLF Tee-off** to great fun with our golf game. One to four players can enjoy these 18 holes while your computer keeps track of players, scores, and delivers a scorecard at the end of each round. Use on Radio Shack Color Computer (16K Extended Color Basic).

■ **FORGET-ME-NOT MAIL MYNDER** Never forget a friend. With Mail Mynder you can update your mailing list quickly. You'll even be able to print a return address with each entry. Mail Mynder prints on two wide dry gum, or adhesive-backed mailing labels. Disk System allows maximum storage capacity; Cassette System stores up to 75 addresses. Use on Radio Shack Color Computer (16K Extended Color Basic).

YES! Send me the programs I have checked below. I have enclosed a check or money order.  
 Send me further information about great business and entertainment programs.

QTY	PRICE EACH	EXTENDED PRICE
GOLF Computer Cassette (No. REM1000)	\$19.95	
Disk (No. REM1000)	\$24.95	
FORGET-ME-NOT MAIL MYNDER Color Computer Cassette (No. REM1300)	\$9.95	
Disk (No. REM1300)	\$12.95	

YOUR ADDRESS

Name \_\_\_\_\_  
Address \_\_\_\_\_  
City \_\_\_\_\_ State \_\_\_\_\_ Zip \_\_\_\_\_

Sub Total (Shipping Included) \_\_\_\_\_  
Tax (No. Res. add. 4%) \_\_\_\_\_  
Total \_\_\_\_\_

US Funds Only

# APM

Access Programs Marketing, Ltd.  
PO Box 23275  
Charlotte, NC 28212

```

B(1)<>100THEN1420
540 IFV=18THEN1430ELSEIFV=19 AND
W=5 ANDB(5)=100THENB(5)=0:P=P-1:
GOTO1440ELSEIFV=19 ANDW=9 ANDB(9
)=100THENB(9)=0:P=P-1:GOTO1440EL
SEIFV=19 ANDW=8 ANDB(8)=100THENB
(8)=0:P=P-1:GOTO1440
550 IFV=19 AND(W>0 AND W<14) AND
B(W)=100THEN1450ELSEIFV=19 AND(W
>0 AND W<14) AND B(W)<>100THEN14
20ELSEIFV=19THENPRINT:PRINT"EAT
WHAT?":GOTO290
560 IFV=17 AND B(4)<>100 THENPRI
NT:PRINT"I DON'T HAVE THE AXE.":
GOTO290
570 ON R GOTO840,840,600,670,740
,800,290,820,840,890,940,980,100
0,1020,1040,1060,1080,840,840,63
0,840,840,840,840,840,760,850,84
0,870,930,840,840
580 IFV=10THEN1410
590 GOTO1310
600 IFV=10 AND W=14 AND B(16)=3
ANDQ3<1THENPRINT:PRINT"ONE OF TH
E TREES HAS A BANANA.":B(5)=3:GO
TO290ELSEIFV=10 ANDW=14 ANDB(16)
=3THEN1410
610 IFV=17 AND W=14 AND B(16)=3T
HENB(16)=0:GOTO1490
620 IFV=10THEN1410ELSEIFV>0THEN1
480ELSEGOTO1310
630 IFV=10THEN1410
640 IFV=11 AND W=5 AND B(5)=100T
HENPRINT:PRINT"THE APE GRABBED T
HE BANANA AND RAN OFF.":B(17)=0
:B(5)=0:D(20,4)=21:P=P-1:GOTO290
ELSEIFV=11 AND W=5THEN1420
650 IFV=15 OR V=17THENPRINT:PRIN
T"THE APE JUST MANGLED YOUR BODY
.":GOTO1570
660 IFV>0THEN1480ELSEGOTO1310
670 IFV=10 ANDW=16 ANDWW=1THENPR
INT:PRINT"IT'S BASIN IS FULL.":G
OTO290ELSEIFV=10 AND W=16 THENPR
INT:PRINT"THE FOUNTAIN IS A STAT
UE WITH A STRANGE FACE.":GOTO290
680 IFV=10 ANDW=17THENPRINT:PRIN
T"THE FACE HAS TWO BEADY EYES, A
BIG NOSE AND AN OPEN MOUTH.":G
OTO290ELSEIFV=10 AND W=18THENPRI
NT:PRINT"IT LOOKS LIKE IT CAN BE
MOVED.":GOTO290
690 IFV=10THEN1410ELSEIFV=12 AND
W=18 ANDWW<>1 ANDCC<>1THENPRINT:
PRINT"CRYSTAL CLEAR WATER CAME O
UT OF THE MOUTH AND INTO A BASIN
.":WW=1:GOTO290ELSEIFV=12THEN146
0
700 IFV=14 ANDW=3 ANDWW=1 ANDB(3
)=100THENPRINT:PRINT"OK...THE CA

```

```

NTEEN IS FULL.":CC=1:WW=0:B*(3)=
"A FULL CANTEEN":GOTO290ELSEIFV=
14 AND W=3 AND WW<>1THENPRINT:PR
INT"HERE IS NO MORE WATER.":GOT
O290
710 IFV=14 AND W=3 AND WW=1THENP
RINT:PRINT"I DON'T HAVE ANYTHING
TO FILL.":GOTO290
720 IFV=13 AND W=19 AND (CC=1 OR
WW=1)THENPRINT:PRINT"GLUB, GLUB
,, GLUB. YUMM!":CC=0:WW=0:B*(3)="
AN EMPTY CANTEEN":GOTO290
730 IFV>0THEN1480ELSEGOTO1310
740 IFV=10 ANDW=35 ANDB(6)=0THEN
PRINT:PRINT"ONE OF THE SKELETONS
HAS AN IVORY TUSK!":B(6)=5:
GOTO290ELSEIFV=10THEN1410
750 IFV>0THEN1480ELSEGOTO1310
760 IFV=10 ANDW=37THENPRINT:PRIN
T"THESE ARE 1,957,321 OF THE
LITTLE SUCKERS!!":GOTO290ELSEI
FV=10THEN1410
770 IFV=15 ORV=19THEN1480
780 IFV=16 ANDW=14 ANDB(22)=R TH
ENR=6:PRINT"OK.":FORT=1TO500:NEX
TT:GOTO240ELSEIFV=16 ANDW=14THEN
1480
790 IFV>0THEN1480ELSEGOTO1310
800 IFV=10THEN1410ELSEIFV=9 ANDW
=20 ANDB(23)=100THENPRINT:PRINT"
ALL RIGHT!...WOODOSH...CLUNK."
:B(23)=8:P=P-1:R=8:FORT=1TO1500:
NEXTT:GOTO240ELSEIFV=9 ANDW=20TH
EN1420ELSEIFV=17 AND W=14THENB(2
2)=0:GOTO1490
810 IFV=16 ANDW=14 ANDB(22)=26TH
ENPRINT"OK.":R=26:FORT=1TO500:NE
XTT:GOTO240ELSEIFV>0THEN1480ELSE
GOTO1310
820 IFV=10THEN1410ELSEIFV=9 ANDW
=20 ANDB(23)=100THENPRINT:PRINT"
HERE I GO AGAIN...WOODOSH...":
R=6:B(23)=6:P=P-1:FORT=1TO1500:N
EXTT:GOTO240ELSEIFV=9 ANDW=20THE
N1420
830 IFV=16 AND W=14THENPRINT"OK.
":R=27:FORT=1TO500:NEXTT:GOTO240
ELSEIFV>0THEN1480ELSEGOTO1310
840 IFV=10THEN1410ELSEIFV>0THEN1
480ELSEGOTO1310
850 IFV=10THEN1410ELSEIFV=16 AND
W=14 ANDB(24)=27THENPRINT"OK.":R
=8:FORT=1TO500:NEXTT:GOTO240
860 IFV=17 AND W=14THENB(24)=0:G
OTO1490ELSEIFV>0THEN1480ELSEGOTO
1310
870 IFV=10THEN1410ELSEIFV=6 ANDW
=36THENCLS:PRINT"THE PIRANHA ATE
ME ALIVE... I'M DEAD.":GOTO1
570ELSEIFV=17 ANDW=14 ANDQ4<1THE

```

```

NB$(25)="A LOG OVER A RIVER.":Q4
=1:GOTO1490ELSEIFV=17 ANDW=14 TH
EN1480
880 IFV=6 ANDW=21 ANDQ4>0THENPRI
NT"OK.":FORT=1T0500:NEXTT:R=9:GO
T0240ELSEIFV>0THEN1480ELSEGOTO13
10
890 IFV=10 ANDW=22 ANDQ5<1THENPR
INT:PRINT"THEY SEEM TO BE VERY A
NGRY!":GOTO290ELSEIFV=10 ANDW=22
THENPRINT:PRINT"THEY'RE HUDDLED
TOGETHER","STUDYING THE MATCHES.
":GOTO290ELSEIFV=10THEN1410
900 IFV=20 ANDW=1 ANDB(1)=100THE
NPRINT:PRINT"THE CANNIBALS ARE A
WED BY THE MATCH FLAME.":Q5=1:
GOTO290ELSEIFV=20 ANDW=1THEN1420
910 IFV=11 ANDW=1 ANDB(1)=100 AN
DQ5=1THENB(1)=0:P=P-1:Q4=1:PRINT
:PRINT"THE CANNIBALS GRAB THE MA
TCHES.":B$(26)="CANNIBALS WITH M
ATCHES":D(10,1)=31:D(10,3)=32:GO
T0290ELSEIFV=11 ANDW=1 ANDB(1)=1
00THENPRINT:PRINT"THE CANNIBALS
AREN'T INTERESTED.":GOTO290
920 IFV=11 ANDW=1THEN1420ELSEIFV
>0THEN1480ELSEGOTO1310
930 IFV=10THEN1410ELSEIFV=6 ANDW
=21THENPRINT"OK.":R=9:FORT=1T050
0:NEXTT:GOTO240ELSEIFV>0THEN1480
ELSEGOTO1310
940 IFV=10 ANDW=39 ANDQ6<1THENPR
INT:PRINT"HE LOOKS VERY GREEDY."
:GOTO290ELSEIFV=10 ANDW=23 THENP
RINT:PRINT"IT HAS A CAVE ENTRENC
E.":GOTO290ELSEIFV=10 ANDW=39THE
N1470ELSEIFV=10THEN1410
950 IFV=11 ANDW=38 ANDQ6<1 ANDB(
20)=100THENB(20)=0:P=P-1:GOTO150
0ELSEIFV=11 ANDW=38 ANDQ6<1THEN1
420ELSEIFV=11 ANDW=6 ANDQ6<1 AND
B(6)=100THENB(6)=0:P=P-1:GOTO151
0ELSEIFV=11 ANDW=6 ANDQ6<1THEN14
20
960 IFV=11 ANDQ6<1THENPRINT:PRIN
T"HE SAYS: HA! HA! YOU MUST THIN
K I'M STUPID!":GOTO290ELSEIFV=11
THENPRINT:PRINT"TO WHOM?":GOTO2
90ELSEIFV=6 AND(W=34 OR W=23)AND
Q6>0THENR=12:PRINT"OK.":FORT=1T0
500:NEXTT:GOTO240
970 IFV=6 ANDW=34THENPRINT:PRINT
"THE EXPLORER WON'T LET ME.":GOT
0290ELSEIFV>0THEN1480ELSEGOTO131
0
980 IFQ7<1THENPRINT:PRINT"THE TO
RCH JUST LIT UP!":B$(11)="A LIT
TORCH":Q7=1:GOTO290
990 IFV=10THEN1410ELSEIFV>0THEN1
480ELSEGOTO1310

```

```

1000 IFQ8<1THENCLS4:PRINT"AAAARG
H!! A SPEAR TRAP!","THE SPEAR WA
S COATED WITH DEADLYKATOOMO POIS
ON! I'LL BE DEAD IN A MATTER OF
SECONDS!":Q8=1:GOTO290
1010 IFV=13 ANDW=19 ANDCC=1 ANDB
(3)=100THENZ1=1:CC=0:B$(3)="AN E
MPTY CANTEEN":PRINT:PRINT"AAAAAH
! THE ANTIDOTE!":GOTO290ELSEIFV=
13 ANDW=19THEN1420ELSEIFV=10THEN
1410ELSEIFV>0THEN240ELSEGOTO1310
1020 IFV=3THEN240ELSEIFZ2<1THENC
LS4:PRINT"A LARGE GATE JUST FELL
AND
BLOCKED THE ONLY EXIT!
":Z2=1:B(27)=14:GOTO290ELSEIFV=1
0THEN1410
1030 IFV=21 ANDW=24 ANDB(13)=100
ANDZ3<1THENPRINT"OK...I SAWED T
HROUGH.":B(27)=0:D(14,1)=13:Z3=1
:GOTO290ELSEIFV=21 ANDW=13 ANDB(
13)<>100THEN1530ELSEIFV=21 ANDW=
13 ANDZ3>0THEN1470ELSEIFV>0THEN1
480ELSEGOTO1310
1040 IFV=10 ANDW=26THENPRINT:PRI
NT"IT HAS A SKULL ON IT.":B(29)=
15:GOTO290ELSEIFV=10 ANDW=27THEN
PRINT:PRINT"THE SKULL HAS THE WO
RD -","(ORREMKNIG) ON IT'S FOREH
EAD.":GOTO290ELSEIFV=10THEN1410
1050 IFV=23 ANDW=27THENPRINT:PRI
NT"OK...THE WALL OPENS UP","REVE
ALING A PASSAGE.":D(15,3)=16:GOT
0290ELSEIFV>0THEN1480ELSEGOTO131
0
1060 IFV=10THEN1410ELSEIF(V=6 OR
V=15 ORV=17)AND(W=29 ORW=30)THEN
1450ELSEIFV=22 ANDW=29 ANDB(11)=
100 ANDZ4<1THENPRINT:PRINT"THE W
EBS BURN AWAY AND THE","SPIDERS
DISAPPEAR!":B(37)=0:B(38)=0:D(16
,3)=17:Z4=1:GOTO290ELSEIFV=22 AN
DW=29 ANDB(11)<>100THEN1540
1070 IFV=22 ANDW=29 ANDZ4>0THEN1
470ELSEIFV>0THEN1480ELSEGOTO1310
1080 IFV=10 ANDW=31 ANDZ5<1 THEN
PRINT:PRINT"IT'S CLOSED.":GOTO29
0ELSEIFV=10 ANDW=31THENPRINT:PRI
NT"IT'S OPEN.":GOTO290ELSEIFV=10
ANDW=32 ANDZ5>0THENPRINT:PRINT"
HE LOOKS VERY MEAN AND HE'S
WEARING A CROWN.":GOTO290ELSEIFV
=10 ANDW=32THEN1470
1090 IFV=10THEN1410
1100 IFV=24 ANDW=31 ANDZ5<1THENP
RINT"OK.":PRINT"OH, OOH...THE GH
OST OF KING
MERRO JUST JUMPE
D OUT!":B(31)=R:Z5=1:GOTO290ELSE
IF(V=15 ORV=22 ORV=17) ANDW=32TH
EN1560
1110 IFV=25 ANDW=33 ANDZ5>0THENF

```

```

ORT=1T019:CLSO:FORCV=1T010:NEXTC
V:CLS5:FORCV=1T010:NEXTCV:NEXTT:
B(31)=0:B(12)=17:GOTO240
1120 IFV=25 ANDW=33THEN1460ELSEI
FV>0THEN1480ELSEGOTO1310
1130 CLS:PRINT:PRINT"YOU HAVE WO
N THIS ADVENTURE... GOOD GOING!
I HOPE YOU ENJOYED IT.":IFB(6)
=100 OR B(6)=R THENK=2
1140 IFK<1THENK=1
1150 PRINT:PRINT"YOU FINISHED WI
TH ";K;" OUT OF TWOTREASURES.":P
RINT@426,"TAP ANY KEY.":SCREENO,
1
1160 IFINKEY$=""THEN1160ELSECLS:
END
1170 GOTO290
1180 IFD(R,1)<>0THENPRINT" NORTH
";
1190 IFD(R,2)<>0THENPRINT" EAST"
;
1200 IFD(R,3)<>0THENPRINT" SOUTH
";
1210 IFD(R,4)<>0THENPRINT" WEST"
;
1220 PRINT:RETURN
1230 FORX=1T039:IFB(X)=R THENPRI
NTB$(X):Q1=1
1240 NEXTX:IFQ1<1THENPRINT"NOTI
NG OF INTEREST."
1250 Q1=0:RETURN
1260 M$="":N$="":INPUT"WHAT SHOU
LD I DO";M$:IFLEN(M$)<4THENFORX=
1T0(4-LEN(M$)):M$=M$+" ":NEXTX
1270 FORX=1T0LEN(M$):IFMID$(M$,X
,1)=" "ANDLEN(M$)>(X+2)THENN$=MI
D$(M$,X+1,4):IFLEN(N$)<4THENN$=N
$+" ":GOTO1290ELSEGOTO1290
1280 NEXTX
1290 IFLEFT$(M$,3)="GO "THENM$="
GO ":RETURN
1300 M$=LEFT$(M$,4):RETURN
1310 PRINT:PRINT"I'M SORRY. I DO
N'T UNDERSTAND.":GOTO290
1320 IFV=1ANDD(R,1)<>0THENR=D(R,
1)ELSEIFV=2ANDD(R,2)<>0THENR=D(R
,2)ELSEIFV=3ANDD(R,3)<>0THENR=D(
R,3)ELSEIFV=4ANDD(R,4)<>0THENR=D
(R,4)ELSEIFV=5THEN1340ELSEPRINT:
PRINT"USE YOUR HEAD...", "YOU CAN
'T GO THAT WAY!":GOTO290
1330 IFR=13THEN1000ELSEIFR=14THE
N1020ELSEGOTO240
1340 CLS4:PRINT"YOU HAVE IN YOUR
POSSESSION.":IFB(23)=100THENPRI
NT:PRINTB$(23):Q2=1ELSEPRINT
1350 FORX=1T020:IFB(X)=100THENPR
INTB$(X):Q2=1
1360 NEXTX:IFQ2<1THENPRINT:PRINT
"NOTHING AT ALL."

```

```

1370 PRINT@426,"TAP ANY KEY.":Q
2=0:SCREENO,1
1380 IFINKEY$=""THEN1380ELSE240
1390 IFP>3THENPRINT:PRINT"YOU'RE
CARRYING TOO MUCH. TAKE (I)NVE
NTORY.":P=P-1:GOTO290ELSEIFW=12T
HEN1400ELSEB(W)=100:PRINT"OK.":B
OTO290
1400 ? INPUT RESPONSES
1410 PRINT:PRINT"I SEE NOTHING S
PECIAL.":GOTO290
1420 PRINT:PRINT"I DON'T HAVE IT
.":GOTO290
1430 PRINT:PRINT"I DON'T KNOW HO
W TO SWIM.":GOTO290
1440 PRINT:PRINT"MMMMMM...THAT T
ASTED GOOD!":GOTO290
1450 PRINT:PRINT"I CAN'T DO THAT
...I'LL BREAK A TOOTH!":GOTO290
1460 PRINT:PRINT"OK...NOTHING HA
PPENS.":GOTO290
1470 PRINT:PRINT"I DON'T SEE IT
HERE.":GOTO290
1480 PRINT:PRINT"I'M SORRY, BUT
I CAN'T DO THAT.":GOTO290
1490 PRINT:PRINT"OK!..CHOP...CHO
P...CHOP...CHOP...KKKRT...TIMBER!
":GOTO290
1500 PRINT:PRINT"THE EVIL EXPLOR
ER TOOK THE RUBY AND RAN INTO TH
E JUNGLE. AS HE RAN HE SAID: SO
LONG SUCKER!":Q6=1:B(36)=0:GOTO
290
1510 PRINT:PRINT"THE EVIL EXPLOR
ER TOOK THE TUSK AND SAID: THIS
TUSK WILL EARN MEA FORTUNE, UNLI
KE THAT GLASS RUBY YOU HAVE!":
Q6=1:B(36)=0:GOTO290
1520 CLS:PRINT:PRINT"THE POISON
SWIFTLY TRAVELED MY BLOOD STREA
M TO YOUR HEART... I AM DEAD."
:GOTO1570
1530 PRINT:PRINT"I DON'T HAVE TH
E HACKSAW.":GOTO290
1540 PRINT:PRINT"I DON'T HAVE AN
Y FIRE!!":GOTO290
1550 CLS:PRINT:PRINT"THE SPIDERS
SWARMED OVER ME... I AM DEAD."
:GOTO1570
1560 CLS:PRINT:PRINT"THE GHOST O
F KING MERRO NOW HAS MY HEAD AS
A COFFIN ORNAMENT..I AM DEAD.":G
OTO1570
1570 PRINT:PRINT"SORRY SUCKER...
"
1580 PRINT"PLAY AGAIN (Y/N)?":S
CREENO,1
1590 A$=INKEY$:IFA$=""THEN1590EL
SEIFA$="Y"THENRUNELSECLS:END

```



# CoCo HEADQUARTERS

Looking to unlock the capacity of your Color Computer?  
Search no more.....

**TOLL FREE  
1-800-251-5008**



## SPECIALS

R/S CoCo upgrades	\$ CALL	26-3026 Color Computer 2 16k	\$ 149.95
64k Memory Upgrade	\$ 59.95	26-3026E Extended CoCo 2 16k	\$ 219.95
Amdek Disk Drives	\$ 499.95	26-3026E64 64k Extended CoCo 2	\$ 299.95
26-3029 CoCo 2 Drive 0	\$ 349.95	26-1261 IP-10 Thermal Printer	\$ 89.95
26-3023 Drive 1	\$ 239.95	26-1192 CGP-115 Printer/Plotter	\$ 179.95
Super Pro Keyboard Kit	\$ 64.95	C. Itoh Banana Serial 50 cps	\$ 249.95
HJL Keyboard kit	\$ 79.95	C. Itoh Prowriter 8510 (par)	\$ 399.95
26-3012 Deluxe Joystick	\$ 34.95	26-1268 CGP-220 Color Jet Ptr.	\$ 599.95
Wico Analog Joystick	\$ 49.95	26-3024 RS Multi-Pac Interface	\$ 149.95

## ACCESSORIES

RS D.C. Modem IB	\$ 89.95	Elephant Disks ssdd	\$ 22.95
Novation J-Cat Modem	\$ 129.95	Verbatim Disks ssdd	\$ 27.95
RS D.C. Modem II	\$ 179.95	Wico Adapter	\$ 19.95
Hayes SM 300 Modem	\$ 239.95	CoCo Switcher	\$ 39.95
USR Password 300/1200	\$ 449.95	Botek ser/par Interface	\$ 69.95

## SOFTWARE & BOOKS

OS-9 (req. 64k)	\$ 64.95 (Disk)	Elite Calc	\$ 59.95 (Disk)
Basic-09 (req. OS-9)	\$ 87.95 (Disk)	Elite Word	\$ 59.95 (Disk)
Color Logo	\$ 44.95 (Rom)	Pooyan by Konami (32k)	\$ 34.95 (C & D)
MSI Diskutil	\$ 19.95 (Disk)	Color Computer Graphics	\$ 5.95
MSI Namelist	\$ 24.95 (Disk)	CoCo Assembly Prog.	\$ 6.95
MSI Color Finance	\$ 49.95 (Disk)	CoCo Programs	\$ 9.95
MSI Color Finance II	\$ 69.95 (Disk)	101 CoCo Programs	\$ 9.95
Color Term Plus	\$ 39.95 (D or R)	Programming the 6809	\$ 14.95
Lancer	\$ 24.95 (Cass)	Basic Faster and Better	\$ 29.95

\*\*\*\*\*  
Call for prices and availability of your other favorite software  
All advertised items subject to availability  
Prices do not include shipping & handling

**TOLL FREE  
TENNESSEE**

**1-800-545-2502**

All of the above units covered by our 120 day carry in warranty.

TRS-80 Trademark Tandy Corporation. Prices subject to change without notice.

Write for our FREE newsletter!

FACTORY DIRECT  
PURE RADIO SHACK EQUIPMENT  
"THE COCO PROFESSIONALS"



**TOLL FREE**  
**1-800-251-5008**  
DELKER ELECTRONICS, INC.  
P.O. BOX 897 DEPT D  
SMYRNA, TN 37167  
800-251-5008  
800-545-2502 (TENNESSEE)  
615-459-2636 (TENNESSEE)  
615-254-0088 (NASHVILLE)

# Creating the Well-Blended Adventure

## Mix

## Mix

ACTIVE INGREDIENTS:

MONSTERS, MAZES,  
DRAGONS, DUNGEONS,  
SERPS, VILLAINS,  
TRIALS, ERRORS,  
RICHES, RUINS,  
MAPS, TRAPS,  
TREASURES, TRASH,  
AND NO ADDED SUGAR

NET WT. 16OZ.

By Eric W. Tilenius

Are you tired of trying to write "Munch Man" in BASIC and having it turn out as "Mush Man"? Turn your creativity to something more rewarding—creating *ADVENTURES*.

This article will show you how you can design your own Adventures in BASIC. As an example, a *Miniventure* will be built step-by-step. I call it a *Miniventure* since it is very small (9 rooms), but contains all the elements you find in most larger adventures.

With a good imagination and your trusty Color Computer, you will soon be on the road to . . . Adventures!

The first step in creating an Adventure program is to come up with a scenario, or setting, for the Adventure. The scenario should give a background to the

*(Eric W. Tilenius is a sophomore at Walt Whitman High School and has been programming and working with computers for several years. He is currently serving as an advisor and consultant to people new to the computer field. During his freshman year, Eric was editor of The Stinson Stylus, a school newspaper.)*

Adventure as well as provide the Adventurer with a main goal to accomplish. Some examples of scenarios are:

- The Adventurer is trapped in an old haunted house. He must search for a lost treasure and find a way out, while avoiding the ghosts, monsters, and other assorted hazards that await him within.
- The Adventurer is on an intergalactic spaceship when it is attacked by hostile enemies. He takes a small shuttlecraft and flees from the ship just before it is destroyed by the enemy. The shuttlecraft, however, runs out of fuel before it can get him to the nearby space station. It crash lands on a nearby planet and is almost totally destroyed by the crash. The Adventurer must now deal with possibly hostile aliens and the many other dangers of the alien environment and try to get off the planet and back to the space station.
- The player lives in a realm of magic and sorcery. He must defeat enemy wizards, battle fierce dragons, and outwit many other creatures in an attempt to rescue a captive princess.

# INTERCEPT 4

By J. Weaver, Jr.

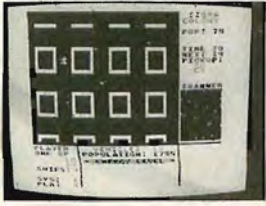

Your ship and the planet are under attack. Hostile alien craft whip around the ship, releasing flaming bolts of energy upon the hull of the INTERCEPT. Immediately your own guns come alive, warding off the sudden attackers, but will it be enough? Already many of the fighters have escaped past your ship toward the defenseless colonies below. Once the air battle is over, you must transport down to the planet, try to find the alien foe, and destroy them. Then, the hardest task awaits: Using the full power of the INTERCEPT, you must battle and destroy the mother ship!! Three separate



screens or levels of play. Each screen scrolls in all four directions. A fantastic new game by the author of Outhouse. Requires two joysticks. 32K..... \$27.95/29.95

## GRAPHICOM

The hit of the Pasadena Color Expo. The greatest graphics program to ever be written for the COCO. Graphicom uses two joysticks or one joystick and one kola pad. The program uses rubber-band graphics and unique method of making stamps and using colors. Each screen is saved on a special disk. When you call up a directory it comes up in pictures to show you what is on the disk.

Graphicom can screen dump graphics to over 20 different printers! Graphicom can send pictures over the modem! Graphicom can reverse the video, rotate pictures, and make mirror images. Graphicom can do more than any other graphics program and its only \$29.95.

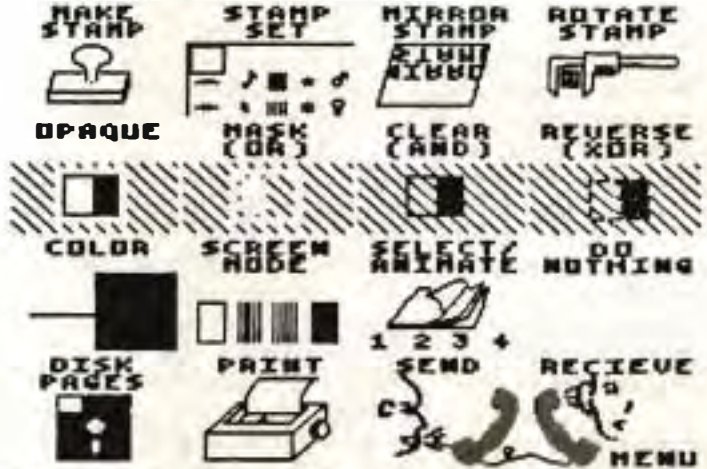

\$10
\$10

This coupon is good on mail order or phone in orders. But you must ask for discount at time of order. Expires 1/31/84.

This coupon is good for \$10 off any order that is for more than \$35.00. (Note: only one discount per order)

\$10
\$10

## TOP TEN FOR THE MONTH OF JANUARY

- |  |   |
|--|---|
| <p><b>#1 TIME BANDIT</b>      <b>Computer Shack</b><br/>A great game written for the COCO this is an original game. The closest arcade game is Tutenkham to which it has a very loose resemblance. Great color and super fun to play..... \$27.95/29.95</p>  | <p><b>#5 POOYAN</b>      <b>Datasoft</b><br/>With their first game since Zaxxon, Datasoft has again paid for the license to bring the arcade game Pooyan to the COCO. This is a very realistic copy of the arcade game. TAPE/DISK ..... \$29.95</p> |
| <p><b>#2 CASHMAN</b>      <b>Computer Shack</b><br/>A great original game for the COCO! A combination of Jumpman and Bagman with many totally original concepts specially designed for the COCO. Excellent one player game. Unbelievably fun to play with 2 players simultaneously. TAPE/DISK..... \$27.95/29.95</p> | <p><b>#6 LUNAR PATROL</b>      <b>Spectral</b><br/>This is an exact copy of the arcade game Moon Patrol. Excellent graphics. TAPE/DISK..... \$24.95/28.95</p>   |
| <p><b>#3 DEMON SEED</b>      <b>Computer Shack</b><br/>Somewhat like the game Phoenix. 3 different waves of demons and bats attack you. Plus you have challenge rounds! Great graphics and fast action. TAPE/DISK..... \$27.95/29.95</p>   | <p><b>#7 FURY</b>      <b>Computer Shack</b><br/>A very loose copy of the arcade game Time Pilot. Excellent color, very fast. TAPE/DISK..... \$27.95/29.95</p>  |
| <p><b>#4 GALAGON</b>      <b>Spectral</b><br/>By the same author who brought you Lunar Patrol. Excellent color and Graphics. A very, very good copy of the arcade game Galaga..... \$24.95/28.95</p>   | <p><b>#8 LANCER</b>      <b>Spectral</b><br/>This is a copy of the arcade game Joust. Excellent graphics and playability. TAPE/DISK..... \$24.95/28.95</p>  |
|  | <p><b>#9 THE KING</b>      <b>Tom Mix</b><br/>A copy of the arcade game Donkey Kong. Very good graphics. TAPE/DISK..... \$26.95/29.95</p>   |
|  | <p><b>#10 OUTHOUSE</b>      <b>Computer Shack</b><br/>A totally new outrageously funny game only available on the COCO. TAPE/DISK..... \$27.95/29.95</p>  |



1691 Eason • Pontiac, Michigan 48054  
 Information: (313) 673-1205  
 Orders Only: Toll Free (800) 392-8881  
 Master Charge and VISA OK. Please add \$3.00 for shipping in the U.S.A. - \$5.00 for Canada. Dealer Inquires Invited.



- The player is a private detective who one day receives an anonymous phone call saying that terrorists have planted a powerful bomb in the center of L. A. He tries to tell the police about this but no one listens. He must discover the bomb's location on his own and deactivate it before it is too late.

As you can see from the examples above, the scenario can be set just about anywhere — real or fictional — but there are a few general rules which should be applied in creating a scenario. First of all, it should be large enough to give the player plenty of room to move about. An Adventure set in Joe's Auto Garage just won't work. Secondly, it should provide the Adventurer with one main goal (finding treasures, for example). Lastly, it should lend itself to the creation of puzzles and obstacles which the Adventurer has to solve. Remember: the more imaginative and creative the scenario, the more fun the Adventure will be to play.

The second step in creating an Adventure is the formation of puzzles and obstacles which the Adventurer must solve and overcome in order to achieve his main goal. You can often get ideas for good puzzles by playing other adventures, but the best puzzles are those that are both original and logical. Obstacles include anything that the player must "physically" overcome (as opposed to puzzles, which are solved mentally) and include anything from locked doors to wandering monsters. Try to think up as many of these as you can that would go with your scenario, and then select those that you think are best. For example, if your scenario was similar to the one with the spaceship above, you might think up some puzzles and obstacles such as these:

- Aliens surround the Adventurer and gesture menacingly at him. He must get past them somehow without arousing their anger.
- The Adventurer must obtain a golden disk in order to enter the walled city of the ancients.
- Once inside the city of the ancients, he must decipher the old scrolls of knowledge which tell where things that he needs are hidden.

### MAPPING IT OUT

Up to now, all you have done is to think about what your scenario would be, and what puzzles and obstacles you could use in such a scenario. Now, however, we begin the "drawing up" of the main part of the Adventure itself.

An Adventure is divided into many locations called rooms. A room can be anything from a closet to a forest. It may have one or more objects in it and may have exits in any of four directions — north, south, east, or west. (Some adventures use up and down also.) When the player enters a room, the computer tells him the above information. Here is an example:

YOU ARE IN A SMALL ALCOVE  
 YOU SEE: HAMMER SHOVEL  
 OBVIOUS EXITS LEAD: EAST WEST

What you have to do now is to create and map out rooms in your Adventure. Take a large piece of paper and draw boxes on it — as many boxes as there are rooms in

your Adventure. If you are not sure how many rooms you will have, start with several boxes and leave room to add on. Each box will represent one room in the Adventure. Now, number each box starting with #1 then 2 then 3, etc. . . . Do not skip numbers! It does not matter what box gets what number, or even if the numbers are in order — only that each box has its own number. It is a good idea to put each number in a corner of the box so that there is room in the box for other things which we will add shortly. Each room in the Adventure will be identified to the computer by the number which you have put in the box.

Now give each room a name and list what, if any, objects are in it. You must also indicate the exits using the following procedure:

1. Connect "rooms" (boxes) that lead to one another by drawing a line from one to another.
2. If one room leads to another but is blocked (by a door, for example), draw a line but mark on that line whatever is blocking it.

If you are a little confused, see Diagram 1. It should help to clear things up.

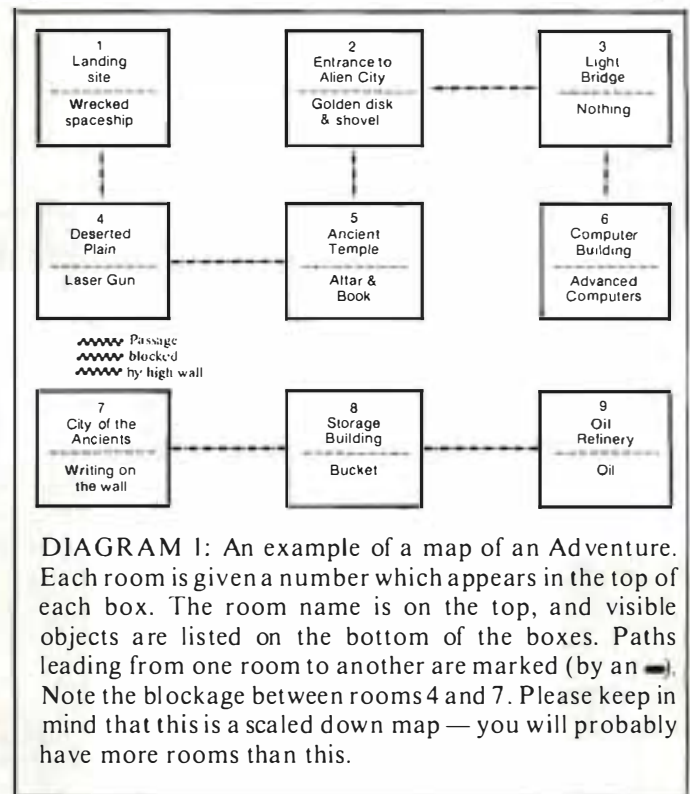

DIAGRAM 1: An example of a map of an Adventure. Each room is given a number which appears in the top of each box. The room name is on the top, and visible objects are listed on the bottom of the boxes. Paths leading from one room to another are marked (by an —). Note the blockage between rooms 4 and 7. Please keep in mind that this is a scaled down map — you will probably have more rooms than this.

Try to incorporate the puzzles and obstacles which you have thought up into the map. For example, in the sample map, the Adventurer must find a way to get over the high wall. Also, in order to get the oil, he must first get the bucket.

Once you have done this and completed your map, you are ready to . . .

### START PROGRAMMING

So far, your CoCo might have just as well been a flower stand. We haven't even touched it! But now let's change all that. Put your map down by your computer, power it up, and get ready to go!

The first step is to get CoCo to remember a "map" of your Adventure. This is done by putting it into *DATA* statements and then reading it into *ARRAYS*. (In case you're a little rusty on your arrays, see chapters 20 & 21 in "Getting Started with Color BASIC." To review *READ* and *DATA* see Pages 94—100 & 127 in the same book.)

Start your program at about line 100. Type in the room names as *DATA*, going in order according to the room numbers. So, for the map above, you would type:

100 DATA LANDING SITE,  
ENTRANCE TO ALIEN CITY,  
LIGHTBRIDGE,DESERTED  
PLAIN,ANCIENT TEMPLE,  
COMPUTER BUILDING,CITY  
OF THE ANCIENTS,STORAGE  
BUILDING, OIL REFINERY

You will probably need more than one program line to do this. Next, type in the data for the objects using this format: *LONG OBJECT NAME, SHORT OBJECT NAME, ROOM* where object is at start of the Adventure. The long object name is a description of the object, such as is on the map. The short object name is one word which the person can use if he wants to *TAKE* the object. (For example, to take the golden disk, a person would say "*TAKE DISK*".) If the object can not be taken (a spaceship, for instance) type an \* instead of a short object name. For the objects on the sample map, you would type in:

200 DATA WRECKED SPACE  
SHIP , \* , 1, GOLDEN DISK,  
DISK,2,,ALTAR,\* ,5, BOOK,  
BOOK,5, LASER GUN, GUN,4,  
ADVANCED COMPUTERS,\* ,  
6,OIL,\* ,9,BUCKET,8,WRITING  
ON THE WALL,\* ,7

The next step is to create what is known as a travel table. The travel table tells what room the player will be in if he moves in one of the four directions. Its format is: *NORTH,SOUTH,EAST,WEST*—each of which represents the number of the room the player would get to if he moved in that direction. If the player cannot move in a certain direction, a zero (0) would

## COLOR FURY

By Tim Purves



The skies the limit in this action packed, airborne, dog fight simulation. All alone, you're surrounded by enemy fighters. Dodge behind a cloud and come out shooting! You'll be passed by paratroopers and tri-fighter forces. Destroy 'em all, and don't spare the ammo. This is a life and death struggle with only one victor!!!

The battle takes place in the air! The enemy attacks with everything they've got, airplanes, helicopters, hot air balloons, paratroopers and magnetic air mines. 16K or 32K. (Tape/Disk) ..... \$27.95/\$29.95

## TIME BANDIT

This month is the first month that the entire top ten panel had copies of Time Bandit and they overwhelmingly voted it into first place. Never before has a game received so many first place votes. At the Dallas Rainbowfest and at the Pasadena Color Expo, arcade players were unanimous in the praise of Time Bandit. "The best original game ever written for the COCO"... "My dad said I could buy only one game and this is the best game here"... "Best game at the show"... "Best game I've ever seen on a home computer"... "Great Game"... Only game I bought at the show"... These are comments we heard about Time Bandit at these two shows... I can say without a doubt that TIME BANDIT is the best game on the market for the COCO.



**WESTERN WORLD:** Visit the Lost Maverick Mine, Dead Man's Pass, (Visit? Escape!) Tombstone Jail, and many more! A variety of screens.

**SPACE WORLD:** Explore Hy-perspace, the bizarre Light Barriers, the Insidious Grid, Gamma Station the Enterprise and others! Bright, Clear graphics!



**FANTASY WORLD:** Conquer the halls of Doom, the Mystic Maze, the Underworld Arena, and other medieval places. Pictured are the three different time gates.

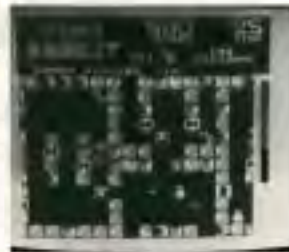

FANTASTIC ADVENTURES AND UNLIMITED RICHES ABOUND  
WHEN ONE TRAVELS THROUGH TIME — YOU ARE THE TIME BANDIT!

Thanks, to Bill Dunlevy and Harry Lafnear, you can transform your Color Computer into the ultimate arcade experience. 32K has never looked or played better!

Tired of games that have only a few screens or force you to follow a strict order of levels? In *TIME BANDIT*, you virtually create your own game! You can choose from more than *TWENTY* places during the entire game, and each place has more than 15 distinct variations and levels of difficulty; this means over 300 variations in all!

You can use the *TIMEGATES* to travel to three different Worlds of Time, each one containing a multitude of colorful and unique adventuring areas. Visit *FANTASY WORLD*, *WESTERN WORLD*, or *SPACE WORLD*. Avoid or destroy the Evil Guardians: the Watching Lurker, Angry Elmo, Killer Smurphs, and lots more! Find the keys which remove various locks preventing your escape. But hurry Bandit—your power is dwindling and time is fleeting! This new machine language game is so exciting, challenging, and fun that you need never leave your home to find an arcade again! Ultra crisp Supergraphics that include colorful scrolling landscapes and full animation of a multitude of characters, amazing sound, and literally *HUNDREDS* of screens - it's all here! The conquest of time and space awaits you..... (32K) \$27.95/\$29.95

1691 Eason ● Pontiac, Michigan 48054

Info: (313) 673-1205

Orders Only: Call Toll Free (800) 392-8881

Master Charge and VISA OK. Please add \$3.00 for shipping in the U.S.A.

**Michtron**

be placed under that direction. If the Adventurer dies by going in that direction, a 1000 would be placed in that direction. If the direction is blocked, a negative number would be placed for that direction. Each room has its own data entry for this, as seen in the travel table for the sample map listed below:

```
300 DATA 0,4,0,0 :REM GOING SOUTH LEADS
TO ROOM 4
310 DATA 0,5,3,0 :REM DATA FOR ROOM #2
320 DATA 0,6,0,2, :REM DATA FOR ROOM #3
330 DATA 1,-1,5,0:REM PASSAGE SOUTH IS
BLOCKED
340 DATA 2,0,0,4
350 DATA 3,0,0,0
360 DATA -1,0,8,0:REM PASSAGE NORTH
BLOCKED
370 DATA 0,0,9,7
380 DATA 0,0,0,8
```

You can make up a list of obstructions and create a value for each. For example: -1 if a wall is blocking the way, -2 if a door is in the way, -3 if a monster blocks the way, etc. . . .

Next, type in the commands (verbs) which you wish your Adventure to recognize. Next to each verb, place a VERB NUMBER. If two verbs are the same (e.g. GET and TAKE) place the same number for each. Use low numbers as it will make things easier for you. These numbers will be used to identify the verbs later on. A

common verb listing is:

```
400 DATA TAKE,1,GET ,1,DROP, 2,GO,3,LOOK,4,
READ,4, MOVE,5, PUSH,5, PULL,5, UNLOCK,6,
OPEN,7, INVENTORY,8
```

Now that you have all your data statements in, we can proceed with the rest of the program. The next thing we are going to do is to READ all of the data into arrays so that we can use it during the game. First we must DIMension the arrays which we will be using. L\$ will stand for the LOCATION and will be used to hold the room names. LO\$ will be used for LONG OBJECT descriptions, O\$ for the short OBJECT names, and O for the room the object is in. C\$ will be for the COMMANDS, and C for the COMMAND numbers. T will be a two dimensional array in which the TRAVEL table will be stored. DIMension them at the start of the program by typing:

```
10 DIM L$(X+1),LO$(Y+1)O$(Y+1),C$(20),T(4,X),
C(20)
```

Replace X in the above statement with the number of rooms you have and replace Y with the number of objects you have. DIMensioning the variables to X+1 and Y+1 leaves room to add objects in later.

Now we can read the data . . . To read the rooms, type: 600 FOR C=1 TO X:READ L\$(C):NEXT C. Simple enough? Just remember to replace X with the number of rooms that you have.

Now for the objects. Type the following, replacing Y

## TDP System 100<sup>®</sup> Color Computer II<sup>®</sup> TRS-80 Color Computer<sup>®</sup>

### SOLDERLESS MEMORY UPGRADES

4K-16K . . . . \$20<sup>00</sup> • 16K-32K . . . . \$40<sup>00</sup> • 4K-32K . . . . \$50<sup>00</sup>  
Installs in 15 minutes without removing SAM chip. Includes Easy-to-follow instructions. IC extractor, RAM button, and 90-day unconditional warranty. Please specify board series. These upgrades are not compatible with the Color Computer II.

### SERIAL SWITCHER

Bi-directional switcher allows you to expand your serial port to two or three peripherals or to connect one peripheral to two or three computers. 2 Ports . . . . \$25<sup>00</sup> 3 Ports . . . . \$30<sup>00</sup>  
Available with mounted Pilot Light—Add \$5<sup>00</sup>

### I.C.s

Basic ROM 1.2 . . . . \$35<sup>00</sup>  
E.C.B. ROM 1.1 . . . . \$100<sup>00</sup>  
D.E.C.B. ROM 1.1 . . . . \$35<sup>00</sup>  
6809E—CPU . . . . \$25<sup>00</sup>  
6883—SAM . . . . \$25<sup>00</sup>  
6847—VDG . . . . \$20<sup>00</sup>  
6821—PIA . . . . \$8<sup>00</sup>  
All four, only . . . . \$65<sup>00</sup>  
4164—64K RAM . . . . \$6<sup>00</sup>  
Set of eight . . . . \$45<sup>00</sup>  
4116—16K RAM . . . . \$1<sup>00</sup>  
Set of eight . . . . \$8<sup>00</sup>

### 64K FOR \$75<sup>00</sup>

This price includes expert installation, a 64K RAM Button, 64K Software (specify disk or cassette), a 64K User Sheet, Return Shipping, and a 90-DAY UNCONDITIONAL WARRANTY. Requires 1.1 or newer Basic ROM and an operating 285 (F) Series Color Computer (D or E Series boards add \$20<sup>00</sup>), TDP-100, or Color Computer II. For fastest response, pay by Cashier's Check or Money Order.

**TERMS:** Cashier's checks and money orders for immediate delivery • Personal checks allow 2 weeks • Orders \$100 to \$199 save 10% • \$200 and over save 15% • California residents add 6% • Orders under \$25 add \$2 shipping • C.O.D. add \$2

4418 E. Chapman Ave., Suite 284  
Orange, CA 92669  
(714) 639-4070

**VIDTRON**

★ FREE ★  
CATALOG

## POKES, PEEKS & EXECS FILE

Get complete Color Computer power with this exhaustive file containing over 100 pokes, peeks & exec commands with full comments for each. Hi-speed pokes, break disables, list disables and much more! We will even give you a bonus - Tape-to-Disk copy program. All this for only \$5.00 (Postpaid). File on Tape \$7.50, File on Disk \$9.50 (Postpaid).

Recent Supplement to Pokes, Peeks & Execs file with 50 additional pokes, peeks & execs, only \$3.00 (Postpaid).

## HIDE-A-BASIC

A perfect utility to protect your programs with 4 self-executing ML routines to disable list, break-key, reset and create an error skip routine. 16K Ext. Basic. Cassette \$16.95.

## CARTRIDGE DUMP

Transfer most Rompaks to tape or disk. No need to take out the disk controller. 16K or 32K Ext. Basic Cassette \$14.95.

## ORDER TODAY!

Send cash, check or MO. We pay shipping & Handling. NYS Residents please add Sales Tax.

MICROCOM SOFTWARE

P.O. BOX 214  
Fairport, NY 14450  
(716) 425-1824

with the number of objects in your Adventure. 700 FOR C=1 TO Y:READ LO\$(C),O(C):NEXT C

This will put all the objects in their place. Now for the travel table. (Remember: X=# of rooms.)

```
800 FOR C=1 TO X:READ
T(1,C),T(2,C),T(3,C),T(4,C):
NEXT C
```

This will store the values of the travel table where T(1,C) is North for room C, T(2,C) is South for room C, etc. . . .

Tell CoCo what each column in the travel table relates to by entering this line:

```
850 T$(1)="NORTH":T$(2) =
"South":T$(3)="EAST":T$(
4)="WEST"
```

Finally, let's string up the commands and command numbers. Count up how many commands you have and replace N in the statement below with that number.

```
900 FOR C=1 TO N:READ
C$(C),C(C):NEXT C
```

Now that you have taken care of all your DATA, tell the computer what room the player will start off in by typing: 950 L=R. Replace R with a room number.

YOU DID IT. All the data is now ready to be used.

### MAKE IT WORK

Data is no good if it is not used, so let's proceed to use it. The first thing the adventure should do is tell the player about his surroundings: the room he is in, visible objects, and visible exits. This is accomplished by these lines. Substitute the number of rooms you have for Y.

```
1000 PRINT "YOU ARE AT
THE ";L$(L)
1010 PRINT"YOU SEE:";
1020 FOR C=1 TO Y:IF O(C)
=L THEN PRINT LO$(
C);" ";
1030 NEXT C
1040 PRINT"OBVIOUS EX-
ITS LEAD:";
1050 FOR C=1 TO 4:IF T(C,L)
>0 THEN PRINT T$(C);
" ";
1060 NEXT C
```



## DEMON SEED

By Jeffrey Sorenson and Philip MacKenzie



### DEMON SEED

Ranked in the top three games for the past four months. An exceptional game with outstanding color and graphics. Fast, fast, fast action and excitement. Many different screens and many different challenge rounds keeps you playing for a long, long time. 32K. \$27.95/29.95

### OUTHOUSE

Reviewed in Hot COCO and Rainbow magazine. Hot COCO says: "I was totally taken by its originality, its outstanding graphics, its delightful sound effects, and, most of all, by its brilliant playability." "It is one of the finest of the genre that I have seen." "A truly superior game and enjoyable game." "I urge all COCO arcade players to purchase this game. It really is one of the best I've seen." All of this in November Hot COCO page 16. Rainbow says: "One of those rare arcade games you can love." "Everything about this game is right." "Outhouse is a winner. Four stars for originality, playability, visuality and pure genius in total presentation." These rave comments were in the December Rainbow page 255. 32K. \$27.95/29.95



### CHOPPER STRIKE

So, what are you waiting for? Pull on your helmet, start the engine, open up the throttle, and take off. You're about to pilot one of the most dangerous missions of our life! A deadly, never ending, obstacle course that'll rack your brains, test your reflexes, and push you to limits never achieved



before. Gun turrets, short range rockets, oil tanks, and ICBM's are just a few of the dangers you're going to encounter. Are you a good enough pilot to accept such a mission? CHOPPER STRIKE, colorful graphics, descriptive sounds, and all out action make it the best chopper game on the market! 16K or 32K. \$27.95/29.95

### CASHMAN

By Doug Frayer and Bill Dunley

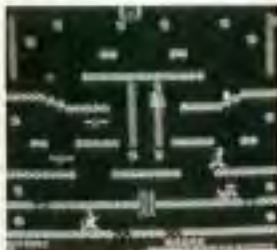

The screen is exploding with colorful, fast moving animation like you've never seen. The speaker is alive with every kind of sound imaginable! Best of all, the player's eyes are glowing with fascination and wonder of this classic creation. THE GAME? CASHMAN!

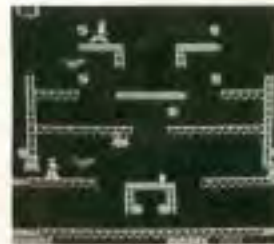

Dozens of levels and screens (more than FORTY!) let anyone from beginner to expert have as much excitement, challenge, and good clean fun as they can stand! Even the least adept player can have the time of their life with CASHMAN, yet with the increased excitement of special MYSTERY PIECES and EXPERT PUZZLE screens, the most experienced arcade addict is guaranteed to never stop playing!

32K COLOR COMPUTER (Tape/Disk)

\$27.95/29.95

# MichTron

1691 Eason • Pontiac, Michigan 48054

Information (313) 673-1205

Orders Only (800) 392-8881

Master Charge and VISA OK. Please add \$3.00 for shipping in the U.S.A. - \$5.00 for Canada. Dealer Inquires Invited.

Line 1000 prints the name of the room you are in (room L). Lines 1020 & 1030 scan to see what objects have the same object number as the room you are in and prints out a description of those objects, LO\$(C). Lines 1050 & 1060 check the *travel table* for the current room and print in what directions the exits lead. You may also add lines to tell the player if there are obstructions and if there are, in what directions they lie.

```
1054 IF T(C,L)=-1 THEN PRINT "A WALL
      BLOCKS YOUR PASSAGE TO THE";T$(C);
```

```
1056 IF T(C,L)=-2 THEN PRINT "A DOOR PRE-
      VENTS YOU FROM GOING";T$(C);"
```

If you have more obstacles, assign them a negative number and put them in their appropriate place in the travel table, and add on lines like the ones above.

Now that you have told the player about his surroundings, the next step is to ask him what he would like to do.

```
1100 PRINT "WHAT WOULD YOU LIKE TO DO
      NOW":INPUT A$
```

Most Adventures use the two-word commands, so that is the system we will adopt for now. The first word that the player types in should be one of the commands that you entered into the computer before. If so, we represent that word by its **COMMAND NUMBER** which you type after the verb in the *DATA* statement. If the first word in the player's command is not in the command list, we will tell the computer to print a message saying so. This procedure is listed below.

```
1199 REM FIND THE FIRST WORD TYPED IN
      (UP TO THE SPACE) AND CALL IT A1$
1200 FOR C=1 TO LEN(A$):IF MID$(A$,C,1)=" "
      THEN (A1$)=LEFT$(A$,C-1):B$=MID$*A$,
```

```
C+1,LEN(A$)-C):GOTO 1230 ELSE NEXT
1210 A1$=A$:REM ONE WORD COMMAND
      SUCH AS LOOK
1230 FOR C=1 TO N:REM N = NUMBER OF
      COMMANDS YOU HAVE IN VERB LIST
1240 IF C$(C)=A1$ THEN A=C(C):GOTO 1400:
      REM IF VERB IS IN COMMAND LIST
      THEN GOTO 1400
1250 NEXT C
1260 PRINT " I DO NOT UNDERSTAND THE
      VERB":GOTO 1100: REM GO BACK TO
      INPUT STATEMENT
```

That, long as it may seem, is one of the fastest ways to sort through a command input. The verb which the player typed in is known to the computer by its verb number (stored as A) and if the player typed in two words, such as GO SOUTH, the second word is stored as B\$. Line 1200 takes care of dividing A\$ into A1\$ and B\$. Lines 1230-1250 check to see if A1\$ is a recognized command.

What good is all that? Well, now that we have torn A\$ to bits and pieces, we can begin doing all sorts of things such as . . .

### MOVING AROUND

Now we tell the computer to *GOTO* various sections of the program depending upon what command was typed. Using the command *ON*. . . *GOTO* is the simplest way to accomplish this.

```
1400 ON A GOTO 2000,3000,4000,5000,6000,7000,
      8000,9000
```

This will send the program to line 2000 for verb #1 (GET or TAKE), line 3000 for verb #2 (DROP), line 4000 for verb #3 (GO), etc. . .

To get things moving, let's start with the routine for GO at line 4000.

#### Rainbow Check Plus

24	03F1	43
700	066F	250
1200	0913	177
2999	0B74	71
5030	0E00	120
END	10FE	42

The listing:

```
0 * LISTING #1
1 REM MINIVENTURE BY ERIC W.
  TILENIUS
2 * TO DEMONSTRATE ADVENTURE PRO
  GRAMMING TECHNIQUES
3 * REQUIRES 16K COLOR BASIC.
  CAN BE FIT INTO 4K BASIC
  IF ALL REMARKS AND SPACES
  ARE DELETED AND IF THE
  TITLE DISPLAY IS LEFT OUT.
4 * DIMENSION ARRAYS USED:
```

L\$=ROOM NAMES

LO\$=LONG OBJECT DESCRIPTION

O\$= SHORT OBJECT NAME

C\$= COMMAND ARRAY

C()=COMMAND NUMBERS

T=2-D ARRAY FOR TRAVEL TABLE

T\$=DIRECTIONS

5 \* O=OBJECT ROOM NUMBER

6 \* DESIGNED TO BE USED WITH  
ACCOMPANYING TUTORIAL

7 X=9 : \* CHANGE TO NUMBER OF ROOM  
S

8 Y=9: \* CHANGE TO # OF OBJECTS

10 DIM L\$(X+1),LO\$(Y+1),O\$(Y+1),  
C\$(20),T(4,X),C(20),O(Y+1)

20 \* TITLE & INSTRUCTIONS

22 CLS3:PRINT " MINIVENTURE"

24 PRINT@128,"DESIGNED TO BE USE  
D WITH ACCOMPANYING TUTOR  
IAL. THIS MINIVENTURE H

AS 9 ROOMS AND 10 OBJECTS ONLY.TH



# CIII

This program lets you copy a color computer disk file (any file basic, text or machine language) to a Model I/III or 4 disk or from a Model I/III or 4 to a color computer disk. This program does no conversions but it will transfer any file to or from a disk. You must have a Model I/III or 4 with 2 disk drives (Model I must be double density). Compatible with most Model I/III operating systems.

Price is \$24.95 for the Model I/III or 4 disk.



## SUPERZAP

An amazing new program for the serious Color Computer Disk user. This program allows the user full access to all of the information on any disk. With 17 menu options, this user-friendly program takes you step by step through the function it performs.

SUPERZAP has a main screen menu that tells you all the options and their corresponding keys. All you do is decide what you need done and the program does the rest. Disk backups, copy sectors, erase tracks, granule maps, kill and list files, modify sectors in HEX or ASCII and more!

No more lost time because of disk problems. SUPERZAP can do it! The ultimate in disk repair and information retrieval. No color computer disk operator should be without it.

DISK ONLY ..... \$29.95

## 64K UPGRADE

If you purchased your COCO within the last year you can plug these chips into it with no trouble. Complete instructions for installing the chips in any computer, (including COCO II). Now only \$59.95.

## BOOK SALE! SAVE UP TO \$6.00

All of our books are discounted during **January**. All books are 10% off and if you buy two or more you will get 20% off the list price. All the books in this ad are only **\$13.25** in January. If you purchase two or more books you will only pay **\$11.95** for each book. These special prices are for Rainbow readers only. You must ask for special prices when ordering. **Order now**. Time is limited.

### PERSONAL COMPUTER COMMUNICATIONS

By Alfred Glossbrenner **\$14.95**  
Everything you need to know about using a modem. How to download free software, how to buy modems, money saving techniques. Best book ever on using your COCO to link up to the outside world.

### ASSEMBLY LANGUAGE GRAPHICS FOR THE TRS-80 COLOR COMPUTER

By Don Inman **\$14.95**  
Written specifically for the TRS-80 Color Computer. This book uses sound and graphics to show how 6809 assembly language can be used to perform tasks that would be difficult or impossible with BASIC. All of the explanations are hands-on, so that the manual can serve as a tutorial.

### PROGRAMMING THE 6809

By Zaks & Labiak **\$14.95**  
This book explains how to program the 6809 in assembly language, covering all aspects progressively and systematically. Beginning with the basics of programming. **Programming the 6809** goes on to explain register and buses, subroutines, the 6809 instruction set, addressing modes, I/O techniques and devices, and finally data structures.

### THE FACTS

By Spectral Associates **\$14.95**  
The facts is a compendium of data designed to explain in detail the internal workings of the Color Computer. A must for any machine language or basic programmer.

### TRS-80 COLOR COMPUTER GRAPHICS

By Don Inman ..... **\$14.95**  
Explore the creative and imaginative blending of computers and color using Color Computer Graphics. This book will enable you to explore all the graphics capabilities of Extended Basic. The book also provides application programs and useful subroutines. 303 pages.

## SMALL BUSINESS BILLING SYSTEM

Imagine having all your customers at your finger tips with the ability to print invoices or monthly bills easily and quickly. Now imagine being able to keep a running total of all customer accounts without having to even pick up a calculator. It's all automatic, just say so and it performs. You can access a customer file, *print a invoice*, *add sales tax*, *shipping cost*, *interest*, and even *service charges* with the simple ease of pushing a button. All at once you'll have time to get the important things done instead of constantly worrying about customer account. That's what you get with **BILLING SYSTEM**. Michtron's Small Business Billing System, not an elaborate accounts receivable program, but a simple and effective way of keeping track of people who owe you money.  
DISK OR TAPE ..... \$29.95



## Double Density Disks Only \$1.75@

At Michtron we buy thousands of disks a month for our own use. We have found that we can save considerable sums of money by buying disks in bulk. That is 100 disks in a box with no sleeves, no labels etc. We can put 10 disks in vinyl sleeves and a plastic box for less money than we can buy the same disks we buy in bulk in a paper box! So we do this and pass the savings on to you.

We buy Sentinal Disks. They are outstanding! We unconditionally guarantee them for the life of your computer. If you ever have a problem with them return them to us and we will give you a refund or exchange them for new ones within 24 hours.

10 disks with tyvek sleeves ... \$175.00  
10 disks with tyvek sleeves ..... \$19.95  
10 disks with vinyl sleeves ..... \$21.95

Disks with vinyl sleeves and a plastic library box, choice of colors, \$23.95

1691 Eason • Pontiac, Michigan 48054

Info: (313) 673-1205

Orders: (800) 392-8881

Master Charge and VISA OK. Please add \$3.00 for shipping in the U.S.A. - \$5.00 for Canada.

Dealers Inquires Invited.



If the person typed GO, B\$ (his second word) should be a direction (e.g. GO NORTH). Let's get oriented and take care of the directions. Remember: T\$(1)="NORTH", T\$(2)="SOUTH", etc.

```

4000 FOR C=1 TO 4:IF B$=T$(C) THEN DR=C:
      GOTO 4020 :REM DR=THE DIRECTION #
      (1-4)
4010 NEXT C: GOTO 4050 :REM NO DIRECTION
      INDICATED
4020 IF T(DR,L)>0 THEN L=T(DR,L): GOTO 4030
      :IF DIRECTION IS NOT BLOCKED THEN
      MOVE PLAYER TO NEXT ROOM AS IN-
      DICATED BY THE TRAVEL TABLE
4025 IF T(DR,L)=<0 THEN PRINT"CAN'T GO
      THAT WAY.":GOTO 1100
4030 IF L=1000 THEN PRINT"YOU JUST DIED."
      :END:REM IF YOU DIE BY GOING IN
      THAT DIRECTION (OFF A CLIFF, FOR
      EXAMPLE) THEN END GAME
4040 GOTO 1000 :REM DESCRIBE ROOM
4050 PRINT"TRY A DIRECTION":GOTO 1100

```

Now the player can move around the setting. Try it. Someone once said that you only *GET* what you *TAKE*. So get ready for the take routine.

There are two main types of objects in and Adventure — those which you can take, and those you can't. If you remember, when you typed in your data, you indicated the "untakable" objects with a \*. The takable objects, on

```

E OBJECT IS TOBRING THE OIL BACK
  TO YOUR SPACESHIP WHICH HAS CRA
  SHED ON AN ALIEN PLANET"
65 FOR C=1 TO 7000:NEXT
100 DATA LANDING SITE, ENTRANCE T
  O ALIEN CITY, LIGHT BRIDGE, DESERT
  ED PLAIN, ANCIENT TEMPLE, COMPUTER
  BUILDING, CITY OF THE ANCIENTS, S
  TORAGE BUILDING, OIL REFINERY
200 DATA WRECKED SPACESHIP, *, 1, G
  OLDEN DISK, DISK, 2, ALTAR, *, 5, BOOK
  , BOOK, 5, LASER GUN, GUN, 4, ADVANCED
  COMPUTERS, *, 6, OIL, *, 9, BUCKET, BU
  CKET, 8, WRITING ON THE WALL, *, 7
300 DATA 0, 4, 0, 0
310 DATA 0, 5, 3, 0
320 DATA 0, 6, 0, 2
330 DATA 1, -1, 5, 0
340 DATA 2, 0, 0, 4
350 DATA 3, 0, 0, 0
360 DATA -1, 0, 8, 0
370 DATA 0, 0, 9, 7
380 DATA 0, 0, 0, 8
400 DATA "TAKE", 1, "GET", 1, "DROP"
  , 2, "GO", 3, "LOOK", 4, "READ", 4, "MOV
  E", 5, "PUSH", 5, "PULL", 5, "UNLOCK",

```

## CP/M FOR YOUR COLOR COMPUTER

- Now have access to the largest library of programs available
- CP/M is the recognized leader in professional and personal software
- Adds the power of a 4 MHz, Z80A
- CP/M 2.2 included
- No modifications are necessary. Simply plug into the cartridge port and plug Radio Shack's disk controller into it.
- Maintains full Radio Shack compatibility
- Requires 64K memory and one or more disks with controller

**\$250.00**

**WAYNE TECHNOLOGY**

P.O. BOX 5196 • ANAHEIM, CA 92804-1196  
(714) 772-5757

Radio Shack™ Tandy / Radio Shack Corp. / CPM™ Digital Research

## EXPAND YOUR COLOR COMPUTER

Compare our prices and features

### TS6551 RS232 SERIAL INTERFACE

- Interface with modems, printers, or terminals
- Easily programmed from BASIC or Assembly Language
- Programmable protocol and baud rates (50 to 19,200)
- Terminal program with 51-column display & lower case
- Flexible programming—send line-feeds if needed
- Interrupt capability
- Comprehensive manual **\$69<sup>95</sup>** cable included  
specify disk or cassette

### TS6821 PARALLEL PRINTER INTERFACE

- Centronics compatible
- Print BASIC program listings, Disk BASIC directory listings and program outputs
- Frees your serial port **\$49<sup>95</sup>** cable included

#### Both interfaces include:

- Quality compact cartridge which plugs into the Color Computer expansion port or Multipak Interface
- Cable and connector (Save \$20 to \$30)

Add \$3.00 shipping

Send check or money order

CA residents add 6% sales tax

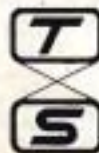

**T&S Electronics**

6111 Romany Drive • San Diego, CA 92120  
(619) 286-0661

```

6, "OPEN", 7, "INVENTORY", 8
600 FOR C=1 TO X:READ L$(C):NEXT
C
700 FOR C=1 TO Y:READ LO$(C),O$(
C),O(C):NEXT C
800 FOR C=1TOX:READ T(1,C),T(2,C
),T(3,C),T(4,C):NEXTC
850 T$(1)="NORTH":T$(2)="SOUTH":
T$(3)="EAST":T$(4)="WEST"
899 N=12:'CHANGE TO # OF VERBS I
N COMMAND LIST
900 FOR C=1 TO N:READ C$(C),C(C)
:NEXT C
950 L=1 :'ROOM TO START AT
999 CLS
1000 PRINT:PRINT"YOU ARE AT THE
";L$(L)
1010 PRINT"YOU SEE:";
1020 FOR C=1 TO Y:IF O(C)=L THEN
PRINT LO$(C);" ";
1030 NEXT C
1035 PRINT
1040 PRINT "OBVIOUS EXITS LEAD:"
;
1050 FOR C=1 TO 4:IF T(C,L)>0 TH
EN PRINT T$(C);" ";
1060 NEXT C

```

the other hand were given a one word name. The TAKE routine listed below checks for that name and also checks if the object is in the same room as you are. If so, the player may take the object. If an object is taken, its OBJECT VALUE, O(C), is changed to 1000.

```

2000 FOR C=1 TO Y:REM Y= # OF OBJECTS IN
ADVENTURE
2010 IF B$=O$(C) AND O(C)=L AND O$(C) < " "
THEN O(C)=1000:PRINTLO$(C)" HAS BEEN
TAKEN.":GOTO 1100:'PLAYER TAKES OB-
JECT
2020 NEXT C
2050 PRINT"SORRY, THAT IS NOT FOR THE
TAKING": GOTO 1100

```

That takes care of that. If, however, you have special cases, such as where you must take oil in a bucket, you can add them in in this fashion.

```

2030 IF B$="OIL" THEN GOTO 2060
2060 IF O(7)=L THEN INPUT"WITH WHAT";I$:IF
I$="BUCKET"AND O(8)=1000 THEN O(7)=
1000:PRINT"TAKEN":GOTO 1100
2062 PRINT"SORRY, YOU ARE UNABLE TO
TAKE THE OIL"

```

O(7) is the object number for oil and O(8) is the object number for the bucket. You can determine these by counting the place it is in in the object data (without counting numbers or long object descriptions).

# BEAR BONES

## COLOR COMPUTER SOFTWARE

# BEAR BONES

16K ST. BASIC ★ NEW RELEASES ★ 14<sup>95</sup> EA.

**Tutor Tapes, Inc.** presents "Tutee - Your Computer Tutor"  
 Providing Practice for Your Child in the Basic Skills of  
 Reading, Spelling, Grammar, Language, and Math (TRS-80/TDP)

### LANGUAGE ARTS

Skill	Grade Level
- Sight Words	K-1, 2, 3
- Rhyming Words	K-1
- Short Vowels	K-1, 2
- Long Vowels	2
- Vowel Combinations	2, 3, 4, 5/6
- Blends/Digraphs	K-1, 2
- Contractions	2
- Synonyms	3, 4, 5/6
- Antonyms	3, 4, 5/6
- Possessives	5/6
- Plurals	3, 4
- Pre-Fixes	4, 5/6
- Suffixes	4, 5/6
- Syllables	3, 4, 5/6
- Accents	5/6
- Vocabulary	5/6

### MATH

Skill	Grade Level
- Before & After	2
- Math:	K-6
Addition	
Subtraction	
Multiplication	
- Division	4, 5/6
- Roman Numerals	5/6
I-C	
- Metrics	5/6

★ 20% DISCOUNT ON  
 QUANTITY ORDERS

Available Soon for  
 ATARI, VIC 20, COMM. 64

MAIL TO: BEAR BONES SOFTWARE, INC.  
 G-3117 CORUNNA RD., SUITE 108  
 FLINT, MICHIGAN 48504

Enclose Check or Money Order  
 Dealer and School  
 Inquiries Welcome

### ORDER FORM

QTY.	SKILL	GRADE L.
_____	SIGHT WORDS	_____
_____	RHYMING WORDS	_____
_____	SHORT VOWELS	_____
_____	LONG VOWELS	_____
_____	VOWEL COMBO	_____
_____	BLENDS/DIGRAPHS	_____
_____	CONTRACTIONS	_____
_____	SYNONYMS	_____
_____	ANTONYMS	_____
_____	POSSESSIVES	_____
_____	PLURALS	_____
_____	PRE-FIXES	_____
_____	SUFFIXES	_____
_____	SYLLABLES	_____
_____	ACCENTS	_____
_____	SPELLING	_____
_____	BEFORE & AFTER	_____
_____	MATH	_____
_____	DIVISION	_____
_____	ROMAN NUMERALS	_____
_____	METRICS	_____
_____	<b>TOTAL @ \$14<sup>95</sup> ea.</b>	_____
_____	20% DISCOUNT If More Than 5 Programs	_____
_____	ORDER TOTAL: \$	_____
_____	Mich. Res. Add 4% Tax	_____
_____	TOTAL ENCLOSED: \$	_____

**SHIPPING FREE**

SHIP TO:

NAME \_\_\_\_\_

ADDRESS \_\_\_\_\_

CITY \_\_\_\_\_

STATE \_\_\_\_\_

ZIP \_\_\_\_\_

## TAKING INVENTORY

Now that the player can take things, he or she might want to get a list of things being carried. This is done by typing INVENTORY. Here is the "INVENTORY ROUTINE." It scans the list of object numbers and when it finds one equal to 1000 it prints that you have taken that object.

```
9000 CLS:PRINT"YOU ARE CARRYING THE
      FOLLOWING:"
9010 FOR C=1 TO Y:REM Y= # OF OBJECTS
      YOU HAVE
9020 IF O(C)=1000 THEN PRINT LO$(C)
9030 NEXT C:GOTO 1100
```

Too bad small shopkeepers don't have it this easy.

No Adventurer likes to carry around an armload of junk, so he may want to get rid of unwanted objects or objects that he no longer has use for. This procedure is naturally enough called . . .

## DROPPING OBJECTS

The drop routine, located at line 3000, checks to see if the player has the object he wants to drop and, if he does, it puts it in the room he is in by changing its object number to the room number.

```
1065 PRINT
1070 IF L=1 AND O(7)=1000 THEN C
LS3:PRINT"Y O U W O N!":PRINT:S
OUND 1,10:SOUND 20,9:SOUND 50,14
:END
1100 PRINT:PRINT"WHAT WOULD YOU
LIKE TO DO NOW":INPUT A$
1199 'FIND THE FIRST WORD TYPED
IN (UP TO THE SPACE) AND CALL IT
A1$
1200 FOR C=1 TO LEN(A$): IF MID$
(A$,C,1)=" "THEN A1$=LEFT$(A$,C-
1):B$=MID$(A$,C+1,LEN(A$)-C):GOT
O 1230 ELSE NEXT C
1210 A1$=A$: 'ONLY ONE WORD TYPED
IN
1230 FOR C=1 TO N
1240 IF C$(C)=A1$ THEN A=C(C):GO
TO 1400 : 'IF VERB IS IN COMMAND L
IST THEN GOTO 1400
1250 NEXT C
1260 PRINT"I DO NOT UNDERSTAND T
HE VERB":GOTO 1100 : 'BACK TO INF
UT STATEMENT
1400 ON A GOTO 2000,3000,4000,50
00,6000,7000,8000,9000
1999 'TAKE ROUTINE
2000 FOR C=1 TO Y
2010 IF B$=O$(C) AND O(C)=L AND
O$(C)<>"*" THEN O(C)=1000:PRINT
LO$(C)" HAS BEEN TAKEN":GOTO 110
0
```

```
3000 FOR C=1 TO Y:# OF OBJECTS
3010 IF B$=O$(C) AND O(C)=1000 THEN O(C)=L:-
PRINT LO$(C)" HAS BEEN DROPPED.":
GOTO 1100
3020 NEXT C
3030 PRINT"SORRY, YOU ARE NOT CARRY-
ING "B$:GOTO 1100
```

Now that the player can drop and take objects, he also might like to LOOK or READ the objects he has, or might just like . . .

## LOOKING AROUND

The LOOK and READ subroutine is different from the rest in that each item requires a separate entry. Look at the example below.

```
5000 'LOOK ROUTINE. B$= WORD FOLLOW-
ING "LOOK"
5010 IF A$=A1$ THEN 1000:'IF ONLY THE WORD
"LOOK" WAS TYPED, GO BACK TO ROOM
DESCRIPTION.
5020 IF B$="WRITING" THEN PRINT"THE WRI-
TING SAYS:'WITH A BUCKET AROUND,
THERE IS OIL TO BE FOUND' "
5030 IF B$="GUN" THEN PRINT"THE GUN IS
MARKED 'PRESS TO FIRE' "
5040 IF B$="DISK" THEN PRINT"THE DISK
```

```
2020 NEXT C
2030 IF B$="OIL" THEN GOTO 2060
2050 PRINT"SORRY, YOU CAN'T TAKE
      THAT":GOTO 1100
2060 IF O(7)=L THEN INPUT"WITH W
HAT";I$:IF I$="BUCKET" AND O(8)=
1000 THEN O(7)=1000:PRINT"TAKEN"
:GOTO 1100
2062 PRINT"SORRY, YOU ARE UNABLE
      TO TAKE THE OIL.":GOTO 1100
2999 'DROP ROUTINE
3000 FOR C=1 TO Y
3010 IF B$=O$(C) AND O(C)=1000 T
HEN O(C)=L:PRINT LO$(C)" HAS BEE
N DROPPED.":GOTO 1100
3020 NEXT C
3030 PRINT"SORRY, YOU ARE NOT CA
RRYING "B$:GOTO 1100
3999 'GO ROUTINE
4000 FOR C=1 TO 4:IF B$=T$(C) THEN
DR=C:GOTO 4020 : 'DR=DIRECTION #
4010 NEXT C:GOTO 4050 : 'NO DIREC
TION GIVEN
4020 IF T(DR,L)>0 THEN L=T(DR,L)
:GOTO 4030 'MOVE TO NEW ROOM
4025 IF T(DR,L)<=0 THEN PRINT"CA
N'T GO THAT WAY.":GOTO 1100
4030 IF L=1000 THEN PRINT"YOU HAV
E JUST DIED":END:'IF PLAYER DIES
, END GAME
4040 GOTO 1000
4050 PRINT"TRY A DIRECTION":GOTO
```

# VIP™

# Library

## ANNOUNCING The VIP Library™ With a Terrific Sale!

Nelson Software Systems is now Softlaw Corporation, under new management. Our Super "Color" Library programs have also undergone a name change. All programs are the same unbeatable Super "Color" Library programs you've heard so much about, but with new VIP names. To introduce our **VIP Library** we are having a special sale on the following pages. Our low prices for such high quality can't be beat so get started today!

### Official Library of Software for the TANO Dragon

(Sold for the TANO Dragon only by TANO Microcomputer Products, Corp. and its distributors)

#### The Library Concept

State of the Art, Quality, Integrity, Compatibility and Affordability. Five things good software must possess. Five things that epitomize the **VIP Library™**. Each program is the diamond of its class, true excellence. These programs are first in features, first in power, first in memory, and all are affordably priced. And for your convenience all disk programs can be backed up.

#### State Of The Art

All **Library** programs are written in machine code specifically for the Color Computer, to work without the interference of a separate operating system such as FLEX. From this comes speed and more workspace for you. Unlike other programs for the Color Computer which are said to be 64K compatible, **VIP Library™** programs are not limited to between 24 and 30K of workspace in 64K. **Library** programs have Memory Sense with BANK SWITCHING to fully use all 64K, thus giving up to 51K with a disk version and up to 53K with a tape version.

#### Easy To Use

Each **Library** program was carefully designed to be extremely easy to use. Built-in on-screen help tables are at your fingertips, as are menus of all kinds. Every effort is made to be logical, intuitive and easy-to-remember commands. The manuals have been thoughtfully prepared to cover every aspect of the program, and they have complete tutorials to get you going right away. We set the standard!

#### Lowercase Displays

State-of-the-Art graphics allow instant use of four display colors, and eight lowercase displays featuring descending lowercase letters. You can select from 51, 64 or 85 columns by 21 or 24 lines per screen, with wide or narrow characters in the 64 display. These screens provide a pleasant and relaxing way to perform your tasks, with as much text on the

---

*"... PICTURE getting your instantaneous investment report over the phone, using it in your spreadsheet calculation, generating a report, and writing a memo including that report and data from your database with your word processor, and all this with VIP Library™ programs . . ."*

---

screen as is possible. Each program is easy to learn and a joy to use. We take pride in the stringent testing done to make these programs perform flawlessly. Every feature, every convenience, sleek, simple and elegant.

#### Total Compatibility

All **Library** programs are compatible. Transfer and use of files between programs is easy and carefree. What's better, when you have learned one program the others will come easy. And every program is the best of its kind available.

#### The Library Programs

For your writing needs is the **VIP Writer™**, and its spelling checker, the **VIP Speller™**. For financial planning and mathematical calculations you can use the **VIP Calc™**. To manage your information and send multiple mailings there is the **VIP Database™**. For sending all these files to and from home or the office and for talking to your friends you can have the **VIP Terminal™**. Finally, to fix disks to keep all your **Library** files in good repair we offer the **VIP Disk-ZAP™**.

#### Mini Disk Operating System

The Disk versions each have a Mini Disk Operating System which will masterfully handle from 1 to 4 drives. It offers smooth operation for such features as the ability to read a directory, display free space on the disk, kill files, save and automatically verify files, and load, rename and append files. **Library** programs simply do not have the limitations of BASIC.

#### Professionalism

The **Library** comes handsomely bound in gold-embossed, padded leatherette binders to grace your work area with the professionalism it deserves. Welcome the **VIP Library™** into your home and office.

A description of each of the **Library** programs, with the special sale price, is contained in the following pages. Please indulge!

©1983 by Softlaw Corporation

# VIP Writer™

(Formerly Super "Color" Writer II)  
By Tim Nelson

RATED TOPS IN RAINBOW, HOT COCO,  
AND COLOR COMPUTER MAGAZINE

## The Official Dragon Microcomputer Word Processor†

The most powerful and easy-to-use word processor is available in the showpiece and workhorse of the **Library: The VIP Writer™**. Because of its undisputed superiority over all Color Computer word processors, it was selected by Dragon Data Ltd. of England and TANO in the U.S., to be the Official Word Processor for their line of Dragon microcomputers.

The result of two years of research, the **VIP Writer™** offers every feature you could desire from a word processor. It is the most powerful, fastest, most dependable and most versatile. With the hi-res display, workspace and compatibility features built into the **Library** the **Writer** is also the most usable.

... Nearly every feature and option possible to implement on the Color Computer. The design of the program is excellent; the programming is flawless... Features for the professional, yet it is easy enough for newcomers to master... Certainly one of the best word processors available for any computer... "October 1983 "Rainbow"

"Word processing with **VIP Writer** is like driving a high-performance vehicle... This Ferrari of a package has more features than **Telewriter**, **Easywriter** (for the IBM PC), or **Applewriter**." October 1983 "Hot CoCo"

The **Writer** will work with you and your printer to do things you always wanted to do. Every feature of your printer can be put to use, every character set, every graphics capability at any baud rate, **EVEN PROPORTIONAL SPACING**. All this with simplicity and elegance. You can even automatically print multiple copies.

Although all versions feature tape save and load, the disk version provides the Mini-Disk Operating System common to the whole **Library**, plus disk file linking for continuous printing.

### Professional features of particular note:

- Memory-Sense with **BANK SWITCHING** to fully utilize 64K, giving not just 24 or 30K, but up to 61K of workspace with the compact version and 50K with the disk version.
- **TRUE FORMAT WINDOW** allowing you to preview the printed page **ON THE SCREEN BEFORE PRINTING**, showing centered lines, headers, FOOTNOTES, page breaks, page numbers, & margins in line lengths of up to 240 characters. It makes **HYPHENATION** a snap.
- A **TRUE EDITING WINDOW** in all 9 display modes for those extra wide reports and graphs (up to 240 columns!).
- **FREEDOM** to limbed any number of **PRINTER CONTROL CODES** anywhere, **EVEN WITHIN JUSTIFIED TEXT**.
- Full 4-way cursor control, sophisticated edit commands, the ability to edit any **BASIC** program or **ASCII** textfile, **SEVEN DELETE FUNCTIONS**, **LINE INSERT**, **LOCATE AND CHANGE**, wild card locate, up to **TEN SIMULTANEOUS** block manipulations, word wrap around, programmable tabs, display memory used and left, non-breakable space, and headers, footers and **FOOTNOTES**.
- Automatic justification, automatic pagination, automatic centering, automatic flush right, underlining, superscripts, subscripts, pause print, single-sheet pause, and print comments.
- Type-ahead, typamatic key repeat and key beep for the pros, **ERROR DETECTION** and **UNDO MISTAKE** features, 3 **PROGRAMMABLE** functions, auto column creation, and an instant on-screen **HELP TABLE**.

32K (Comes with tape & disk) \$59.95

†Sold as the Dragon **Writer™** ONLY by Dragon Data Ltd. and its distributors.

# VIP Speller™

A BRAND NEW SPELLING CHECKER!

By Bill Argvros

Spelling checkers are an invaluable aid to every writer. Habitual misspellings and typos can be found without the eyestrain, boredom and fatigue associated with endless proofreading. The **VIP Speller™** is a fast, machine-code proofreading program to correct any **VIP Library™** file. It automatically proofreads your documents against a 30,000 word mock dictionary, plus a dictionary you can create, and corrects typos or marks them for special attention. Unlike other spelling checkers, the new **VIP Speller** distinguishes between upper and lowercase letters, and it shows the misspelled word in context so you can be sure of your correction. Compatible with all CoCos word processors.

32K DISK ONLY \$39.95

Lowercase displays not available with this program.

# VIP™

# Library

# VIP Calc™

(Formerly Super "Color" Calc)

**TRUE VISICALC™ POWER!**

By Kevin Herboldt

- \* **UP TO 5 TIMES THE SCREEN DISPLAY AREA OF OTHER SPREADSHEETS!**
- \* **STATE OF THE ART LOWERCASE DISPLAYS**
- \* **MEMORY SENSE WITH BANK SWITCHING FOR UP TO 40+K in 64K!**
- \* **EXCLUSIVE VIDEO DISPLAY WINDOWS — EVEN UP TO 16!**
- \* **USER-DEFINABLE WORKSHEET — UP TO 512 COLUMNS BY 1024 ROWS**
- \* **WORKS WITH ANY PRINTER, EVEN LETTER QUALITY!**
- \* **LOCATE COMMAND TO FIND SPECIFIC NUMBERS, LABELS OR FORMULAS**
- \* **SORT COMMAND FOR EASY RANKING OF RESULTS**
- \* **ALMOST UNLIMITED PROGRAMMABLE FUNCTIONS**

**VIP Calc™** is truly the finest and easily the most powerful electronic worksheet and financial modeling program available for the Color Computer. Now every Color Computer owner has access to a calculating and planning tool better than **VisiCalc™**, containing all its features and commands and then some, **WITH USABLE DISPLAYS**. Use **Visicalc** templates with **VIP Calc™**!

There's nothing left out of **VIP Calc™**. Every feature you've come to rely on with **VisiCalc™** is there, and then some. You get up to **5 TIMES** the screen display area of other spreadsheets for the Color Computer and Memory-Sense with **BANK SWITCHING** to give not just 24, or 30, but **UP TO 61K OF WORKSPACE IN 64K!!!** This display and memory allow you the **FULL SIZE, USABLE WORKSHEETS** you require. You also get: User definable worksheet size, up to 512 columns by 1024 rows! \* Up to **SIXTEEN VIDEO DISPLAY WINDOWS** to compare and contrast results of changes \* **15 DIGIT PRECISION** \* Sine, Cosine and other trigonometric functions, Averaging, Exponents, Algebraic functions, and **BASE 2, 8, 10 or 16** entry \* Column and Row, Ascending and Descending **SORTS** for comparison of results \* **LOCATE FORMULAS OR TITLES IN CELLS** \* Easy entry, replication and block moving all frames \* Global or Local column width control up to 78 characters width per cell \* Create titles of up to 255 characters per cell \* Limitless programmable functions \* Typamatic Key Repeat \* Key Beep \* Typeahead \* Print up to 255 column worksheet \* Prints at any baud rate from 110 to 9600 \* Print formats savable along with worksheet \* Enter **PRINTER CONTROL CODES** for customized printing with letter quality or dot matrix printer \* Combine spreadsheet tables with **VIP Writer™** documents to create ledgers, projections, statistical and financial reports and budgets.

Both versions feature Tape save and load, but the disk version also has the Mini-Disk Operating System of the entire **Library**.

32K (Comes with tape & disk) \$59.95

does not allow hi-res display in 32K

# NEW SALE PRICES!

## Check These Library Features:

- Fully CoCo 2 Compatible
- Nine Display Formats: 32 by 16  
51, 64, 85 by 21 or 24
- True Lowercase & Descenders
- Four Different Display Colors
- 32 & 64K Compatible
- Memory Sense - Bank Switching
- Up to 51K Disk, 53K Tape
- Mini Disk Operating System
- Compatible With All Printers

## A SPECIAL OFFER ON THE WHOLE LIBRARY —

The entire Library, all six great disk programs, can be purchased for only \$300!

# VIP Terminal™

(Formerly Super "Color" Terminal)

RATED BEST IN JANUARY 1984 "RAINBOW"

By Dan Nelson

From your home or office you can join the communication revolution. The **VIP Terminal™** opens the world to you. You can monitor your investments with the Dow Jones Information Service, or broaden your horizons with The Source or CompuServe, bulletin boards, other computers, even the mainframe at work.

For your important communication needs you've got to go beyond software that only lets you chat. You need a smart terminal so that you can send and receive programs, messages, even other **VIP Library** files. **VIP Terminal™**, the official Dragon microcomputer terminal, does much more than any other terminal and does it reliably. None can compare in features.

**FEATURES:** Choice of 8 hi-res lowercase displays \* Memory-Sense with BANK SWITCHING for full use of workspace \* Selectively print data at baud rates from 110 to 9600 \* Full 128 character ASCII keyboard \* Automatic graphic mode \* Word mode (word wrap) for unbroken words \* Send and receive **Library** files, Machine Language & BASIC programs \* Set communications baud rate from 110 to 9600; Duplex; Half/Full/Echo; Word length: 7 or 8; Parity: Odd/Even or None; Stop Bits: 1-9 \* Local linefeeds to screen \* Save and load ASCII files, Machine Code & BASIC programs \* Lowercase masking \* 10 Keystroke Multiplier (MACRO) buffers to perform repetitive pre-entry log-on tasks and send short messages \* Programmable prompt or delay for send next line \* Selectable character trapping \* Send up to ten short messages (KSMs), each up to 255 characters long, automatically, to save money when calling long distance.

All versions allow tape load and save of files and KSMs, but the disk version also has the Mini Disk Operating System common to the **Library**.

32K (Comes with tape & disk) \$49.95

16K Rompak (While they last) \$49.95

(Tape does not allow hi-res displays in 16K)

Softlaw

8072 Lyndale Avenue So. 812/961-2777

Minneapolis, Minnesota 55420 U. S. A.

TRS-80 is a trademark of Tandy Corp. VIPCalc is a trademark of VIP Corp.

**AUTHOR'S SUBMISSIONS  
ARE ENCOURAGED.**

# VIP Database™

(Formerly Super "Color" Database)

INCLUDES MAIL MERGE CAPABILITIES TOO!

By Tim Nelson

This high speed MACHINE LANGUAGE program fills all your information management needs, be they for your business or home. And it does so better than any other database program for the Color Computer, featuring machine code, lowercase screens and mailmerge capabilities. Inventory, accounts, mailing lists, family histories, you name it, the **VIP Database™** will keep track of all your data, and it will merge **VIP Writer™** files.

The **VIP Database™** features the **Library** Memory Sense with BANK SWITCHING and selectable lowercase displays for maximum utility. It will handle as many records as fit on your disk or disks. It is structured in a simple and easy to understand menu system with full prompting for easy operation. Your data is stored in records of your own design. All files are fully indexed for speed and efficiency. Full sort of records is provided for easy listing of names, figures, addresses, etc., in ascending or descending alphabetic or numeric order. Records can be searched for specific entries, using multiple search criteria. With database form merge you may also combine files, sort and print mailing lists, print "boiler plate" documents, address envelopes - the list is endless. The math package even performs arithmetic operations and updates other fields. Create files compatible with the **VIP Writer™** and **VIP Terminal™**. Unlimited print format and report generation with the ability to imbed control codes for use with all printers.

As with all other **Library** programs, the **Database** features the powerful Mini Disk Operating System.

32K DISK \$59.95

64K Required for math package.

# VIP Disk-ZAP™

(Formerly Super "Color" Disk-ZAP)

RAVED ABOUT IN THE APRIL 1983 "RAINBOW!"

By Tim Nelson

Your database file disk, form letter disk, or BASIC program disk goes bad. An I/O error stops loading, or even backing up of the disk. Weeks, even months of work sit on the disk, irretrievable. Now catastrophic disk errors are repairable, quickly and with confidence, using the **VIP Disk-ZAP™**. It is the ultimate repair utility for simple and quick repair of all disk errors. Designed with the non-programmer in mind, the **VIP Disk-ZAP™** will let you retrieve all types of bashed files, BASIC and Machine Code programs.

This high-speed machine code disk utility has a special dual cursor screen display to look at the data on your disk. You are able to: Verify or modify disk sections at will \* Type right onto the disk to change unwanted program names or prompts \* Send sector contents to the printer \* Search the entire disk for any grouping of characters \* Copy sectors \* Backup tracks or entire disks \* Repair directory tracks and smashed disks \* Full prompting to help you every step of the way \* 50-plus page Operators Manual which teaches disk structure and repair.

16K DISK \$39.95

Lowercase displays not available with this program.

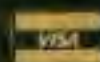

For Orders ONLY  
— Call Toll Free —



# 1-800-328-2737

Order Status and Software Support call (612) 881-2777

Available at Dealers everywhere.

If your Dealer is out of stock ORDER DIRECT!

In Canada distributed by Kelly Software Distributors, LTD.  
**MAIL ORDERS:** \$3.00 U.S. Shipping (\$5.00 CANADA; \$10.00 OVER-SEAS). Personal checks allow 3 weeks.

**All Disk Programs are also available on 3" Diskettes for the Amdek Color AMDISK-III Micro-Floppy Disk System for an additional \$3.00 each.**

©1983 by Softlaw Corporation

SHOWS A PICTURE OF A WALL. UNDER-  
NEATH THE PICTURE ARE THE WORDS  
'USE ME TO OPEN DOORS.'

5090 PRINT:GOTO 1100

As you can see from the above example, each object that can be LOOKed at is listed, followed by what the player sees when he looks at the object.

### MAKING THE RIGHT MOVE

In some Adventures, it is necessary to move certain objects to find other objects (such as moving a bed to reveal a trap door). We can keep track of these objects by assigning a variable to them. If that variable is O, as it is whenever the game is RUN, the object has not been moved. When the player MOVES the object, the object below it is revealed. Such is the case in the sample "Miniventure" we have been making as we go along. In it, the player must MOVE the altar in order to find a hidden door. Here is a sample MOVE routine.

```
6000 'MOVE ROUTINE
6010 IF B$="ALTAR" AND L=5 THEN PRINT
      "THE ALTAR MOVES, REVEALING A HIDDEN DOOR.":LO$(10)="DOOR":O$(10)="*":
      O(10)=5:ALTAR=1:GOTO 1100
```

If the player typed "MOVE ALTAR," and he was in the same room as the altar (room 5), the program would PRINT that a previously hidden door was revealed. It would then add the door at the end of the object list (in this case as object 10), identifying it as an immovable object, and placing it in room 5. Next it would change the value of ALTAR from 0 to 1 — indicating that the altar has been moved. From there, it zooms back to line 1100 to ask what the player wants to do. Note that in the verb list, if the player types PUSH or PULL the computer will go to the same routine.

```
1100
5000 'LOOK ROUTINE
5010 IF A$=A1$ THEN 1000:'ONLY L
      OOK TYPED
5020 IF B$="WRITING" THEN PRINT"
      THE WRITING SAYS 'WITH A BUCKET
      AROUND, THERE IS OIL TO BE FOUND
      ' "
5030 IF B$="GUN" THEN PRINT"THE
      GUN IS MARKED 'PRESS TO FIRE"
5040 IF B$="DISK" THEN PRINT"THE
      DISK SHOWS A PICTURE OF A WALL.
      UNDERNEATH THE PICTURE ARE THE
      WORDS 'USE ME TO OPEN DOORS'"
5090 PRINT:GOTO 1100
6000 'MOVE ROUTINE
6010 IF B$="ALTAR" AND L=5 THEN
      PRINT"THE ALTAR MOVES, REVEALING
      A HIDDEN DOOR.":LO$(10)="DOO
      R":O$(10)="*":O(10)=5:ALTAR=1:Y=
      Y+1:GOTO 1100
7000 'UNLOCK ROUTINE
7010 IF B$="DOOR" AND ALTAR=1 AN
```

### UNLOCKING SECRETS

The Adventurer has discovered a door. The door may be in one of three states: open and unlocked, closed and unlocked, or closed and locked. For the Adventure, we will represent these possibilities by numbers: 0 for closed and locked, 1 for closed and unlocked, and 2 for open and unlocked. DOOR will be the variable used for this purpose. If you have more than one door, you could call them D1, D2, etc.

When the player comes to the door, it is in its default position — closed and locked (0). Thus before he can open it, he must UNLOCK IT. Unlocking doors and the like can be achieved very simply:

```
7000 'UNLOCK ROUTINE
7010 IF B$="DOOR" AND ALTAR=1 AND L=5
      THEN INPUT"WITH WHAT";I$:IF I$=
      "DISK" AND O(2)=1000 THEN PRINT"THE
      DOOR UNLOCKS":DOOR=1:GOTO 1100
7030 IF B$="DOOR" THEN PRINT"YOU FIND
      YOURSELF UNABLE TO UNLOCK THE
      DOOR.":GOTO 1100
```

Line 7010 checks that the ALTAR has been moved, and if you are in the room with the door (room 5). If so, it asks you "WITH WHAT?" If the player had looked at the disk, he would have seen that it said "FOR UNLOCKING DOORS." If he replies DISK to the question and has the disk (object #2) then the door unlocks. (Unlocking doors with disks may seem out of place to you, but remember that this is an alien planet you crashed on.)

### AN OPEN AND SHUT DOOR

Now that the player has successfully unlocked the door he can OPEN it. In order for him to do that though, he must: 1) be in the same room as the door, and 2) have first unlocked the door. The OPEN routine listed

```
D L=5 THEN INPUT"WITH WHAT";I$:I
      F I$="DISK" AND O(2)=1000 THEN P
      RINT"THE DOOR UNLOCKS":DOOR=1:GO
      TO 1100
7030 IF B$="DOOR" THEN PRINT"YOU
      CAN'T UNLOCK THE DOOR."
8000 'OPEN ROUTINE
8010 IF B$="DOOR" AND L=5 AND DO
      OR=1 THEN DOOR=2:PRINT"THE DOOR
      SWINGS OPEN."
8020 IF DOOR=2 THEN T(2,5)=7:T(1
      ,7)=5
8025 IF DOOR=0 AND B$="DOOR"THEN
      PRINT"THE DOOR IS LOCKED"
8030 GOTO 1100
8999 'INVENTORY
9000 CLS:PRINT"YOU ARE CARRYING
      THE FOLLOWING:"
9010 FOR C=1 TO Y
9020 IF O(C)=1000 THEN PRINTLO$(
      C)
9030 NEXT C:GOTO 1100
10000 END
```



# ARIZONA DISCOUNT SOFTWARE

1110 S. ALMA SCHOOL RD #5 159 • MESA ARIZONA 85202 • PHONE (602) 839-8233 • COMPU SERVE ID # 71545.1236

## FEBRUARY SUPER SPECIALS

64K RAMS .....	49.95
W/PURCHASE OF TELEWRITER OR ANY VIP PROGRAMS	44.95
HAYS SMARTMODEM .....	235.00
SMARTMODEM W/VIP TERMINAL .....	275.00
LCA 47 LOWER CASE ADAPTER .....	59.95

## GAMES ARE 20% OFF

### TOM MIX

	TAPE	DISK
ELECTION .....	19.95*	NA
SR 71 .....	22.35*	NA
BUZZARD BAIT .....	22.35*	NA
CU*BER .....	22.35*	NA
DEVIL'S ASSAULT .....	22.35	NA
AIR TRAFFIC CONTROL .....	22.35*	NA
JOURNEY TO MT. DOOM .....	NA	22.35*
THE KING .....	21.55*	NA

### COMPUTERWARE

JR'S REVENGE .....	23.15*	NA
BLOC HEAD .....	21.55	NA
MOON HOPPER .....	19.95*	NA
TIME PATROL .....	21.55*	NA
HYPER ZONE .....	21.55*	NA

### SPECTRAL ASSOCIATES

LANCER .....	19.95*	23.15*
WHIRLYBIRD RUN .....	19.95*	23.15*
GALAGON .....	19.95*	23.15*
FROGGIE .....	19.95*	23.15*
LUNAR ROVER PATROL .....	19.95*	23.15*
CUBIX .....	19.95*	23.15*
MS GOBBLER .....	19.95*	23.15*

### COLORQUEST

FYR-DRACA .....	19.95*	23.15*
FEMBOT'S REVENGE .....	19.95*	23.15*
XYGOID .....	15.95	19.95*
BEYOND THE CIMEEON MOON .....	19.95*	23.15*
ADVENTURE TRILOGY .....	19.95	23.15*
MS. NIBBLER .....	15.95	19.95
INTERCEPTOR .....	15.95*	19.95*
KOMET-KAZE .....	15.95*	24.95

\*32K



## GREAT VALUES!!!!!! MICRO WORKS

MACRO 80C Disk Only	84.95
TOM MIX	
SCREEN PRINT-EPSON	14.35
SCREEN PRINT OKI	15.95

**THESE SPECIAL PRICES**  
Good Through Feb. 15,  
1984

### BUSINESS & UTILITIES

#### PRICKLY PEAR

	TAPE	DISK
CLONE MASTER .....	NA	29.95*
OMNI TAPE CLONE .....	23.95	NA
COLORKIT .....	29.70	33.95*
MAILING LIST .....	NA	39.95*
DISK ZAPPER .....	NA	27.95*
DISK MASTER .....	NA	19.95*
DISK MANAGER .....	NA	23.95*

For AMDEK Disks add 5.00

#### ELITE

	TAPE	DISK
ELITE*CALC .....	50.95	50.95
ELITE*WORD-Includes Mail Merge!!	47.95	47.95
ELITE*FILE .....	NA	50.95
ALL THREE ELITE PROGRAMS		144.95

#### SOFTLAW CORP

Vip Programs are Disk Only

	DISK
VIP WRITER .....	47.95
VIP CALC .....	50.95
VIP DATABASE .....	50.95
VIP TERMINAL .....	42.45
VIP SPELLER .....	42.45
VIP DISK ZAP .....	42.45
THE WHOLE LIBRARY (DISK)	250.00
THE BUSINESS LIBRARY	104.95

(Writer, Calc, Database, Speller on DISK)

	TAPE	DISK
COGNITEC .....		
TELEWRITER 64 .....	42.45	50.95

#### RAINBOW CONNECTION SOFTWARE

	TAPE	DISK
SUPER SCREEN MACHINE .....	38.70	40.70

(The Best Screen Utility around)

## DEALERS!!

For Complete COCO Support call:

DAVID COFFMAN



**ROADRUNNER** COMPUTER PRODUCTS

3908 E. Willow, Phoenix, AZ, 1-602-971-9131

AVAILABILITY SUBJECT TO CHANGE WITHOUT NOTICE

## TO ORDER:

WE ACCEPT VISA, MASTERCARD, PERSONAL CHECKS (2 WEEKS CLEARANCE TIME PLEASE), AND MONEY ORDERS. INCLUDE \$2.00 FOR POSTAGE AND HANDLING. ARIZONA RESIDENTS ADD 6% SALES TAX.

NO COD ORDERS PLEASE!

24 HOUR ORDER LINE

**800-221-9280 EXT. 988**

(ORDERS ONLY PLEASE)



INQUIRIES, ARIZONA ORDERS



**(602) 839-8233**

below takes care of that.

```
8000 ' OPEN ROUTINE
8010 IF B$="DOOR" AND L=5 AND DOOR=1
    THEN DOOR=2:PRINT"THE DOOR SWINGS
    OPEN."
8030 GOTO 1100
```

Of course, it does no good just to have an open door leading to nothing. So, let's modify our travel table so the door, which lies to the south, leads to the City of the Ancients (room 7).

```
8020 IF DOOR=2 THEN T(2,5)=7: T(1,7)=5
```

This modifies the travel so that a south passage from room 5 leads to room 7 and a north passage from room 7 leads to room 5. The player has now successfully gotten around the wall by taking another route.

### AND THE WINNER IS . . .

Congratulate yourself. Your Adventure is 95 percent complete (who said you couldn't write an Adventure). The remaining five percent is printing a title page and instructions (if necessary) and congratulating the player when he solves the Adventure.

Usually, the Adventure is solved when the player brings some key object or objects where they are supposed to be. You can put a check in where the Adventure prints the room description to see if this is the case. In this sample called *Miniventure*, the player must bring the oil back to the room with the spaceship. The check to see if

he won is this:

```
1070 IF L=1 AND O(7)=1000 THEN CLS3: PRINT"
    Y O U   W O N ! " : END
```

There! A 100 percent complete Adventure!

So get busy, think up some great ideas, and maybe you can win *the Rainbow's* Adventure Contest! But even if you don't, creating an Adventure can be a very rewarding experience. After all, an Adventure is just as much a creative piece of your imagination as it is a computer program.

### Suggested Further Reading:

**Writing BASIC Adventure Programs For The TRS-80.** by Frank Dacasta. TAB Books Inc., Blue Ridge Summit, PA 17214. Price: \$9.95. This is a well written book on Adventure programming, but it is primarily for the Models I and III. Available from local book stores or direct from the publisher.

**Adventure Writing Data Sheet.** Available from Aardvark, Ltd., 2352 S. Commerce Rd., Walled Lake, MI 48088. Price: \$4.95. Gives instructions primarily on how to program Adventures. Includes a program listing of an Adventure called *Deathship*.

**Micro Adventurer.** A monthly magazine devoted solely to Adventures and strategy games. Write to: Business Press International, 205 E. 42nd Street, New York, NY 10017 for more details.

**The Rainbow Book of Adventures.** A 112-page book just released by Falsoft, Inc., publishers of *the Rainbow*. It contains award winning Adventures selected from entries in the First Annual Rainbow Adventure Contest. Price: \$7.95. For an additional \$8, you may obtain the *Rainbow Adventure* Tape, a cassette with all 14 Adventures ready to load and run. Contact *the Rainbow* for details.

## + FIRST AID +

### TROUBLE FORMATTING PROGRAMS?

**Rx:** REUSABLE, DOUBLE-SIDED

### PRINT @ LOCATION FINDER

Now it's a breeze to locate any X,Y location at a glance . . . without leaving your program.

Each location clearly numbered on erasable laminate. Use it and reuse it for years of accurate word processing and graphics formatting. Instructions included.



PRICE ONLY \$8.00  
(shipping included)  
(Calif. Res. add 6% Sales Tax)

Call for low prices on drive cables.

# SYNTACTICS

REDCREST, CALIFORNIA 95569, (707) 722-4280

## CPP Color Picture Plotter

Capture that PMODE 3 picture on paper using the CGP-115 Color Graphic Printer. Easy to use • High speed machine language • Auto start from cassette • Works with Micro Painter • Prints pictures from cassette or memory • Includes sample picture (American Flag).



"CPP is a great utility. . ." RAINBOW July 83

still just **14.95** + postage & handling

## Banners Banners Banners

This program makes them on the CGP-115 Color Graphic Printer. Up to 250 letters per Banner with variable sized letters in any of the 4 colors on the CGP. Change colors and size within the Banner. Great for parties, advertising or greeting cards.



**NEW NEW NEW** only **9.95** + postage & handling

### ALL-AMERICAN ULTRALIGHT IND. (AUI)

1144 Kingston Ln.  
Ventura, CA 93001

Please include \$1.50 for postage and handling



# NEW for your COLOR COMPUTER

## Switchable Expansion Is Here

### CoCo HAS A COMPANION!!

GOOD NEWS Switch over to more versatility with the new BT-2000 COMPANION. Save CoCo's connector with the best COMPANION it will ever have.

- Load 5 cartridges into the COMPANION and avoid the hassles while enjoying the benefits of push-button selection.
- Push a Button or select from your keyboard to turn on one of your 5 selections. Handy indicator lights let you know at a glance which cartridge is connected.
- No More Turn-Offs. Just switch to the next cartridge in your COMPANION. Push a button to Restart without turning off the power.
- Plug-in. Fill one to five slots for flexible programming, game playing or both. Choose ROM Packs, serial ports, parallel ports, or disk drives. Then do what you like to do best. The most powerful and cost effective expansion you will find for just \$225.00

### FOR THE ADVANCED USER OR EXPERIMENTER

- The utmost in expansion power and versatility is the BT-1000 Expansion Interface Unit. \$250.00
- Large Built-in power supply to power your peripherals and experimenter circuits.
- Space for your ML utilities with optional 8K of RAM. \$275.00



### ALSO NEW FROM BASIC TECHNOLOGY!!

- BT-1010 PPI Parallel Printer Interface. Free-up CoCo's serial port. Run your printer at top speed. Five foot cable with Centronics compatible connector and machine language printer driver are included. \$79.95
- BT-1020 Real Time Clock/Calendar. Let CoCo keep the time and date for your programs and files. Day-light savings time and leap year keep you on time. Save data or program memory even when power is off with 50 bytes of battery backed memory. Alarm capability to turn on the coffee pot. All for only \$109.00. 
- BT-1030 VIP Versatile Interface Port. Connect CoCo to the outside world with two 8-bit parallel ports, two 16-bit timer/counters and a serial shift register. All user programmable. \$69.95.
- WRITE FOR FREE BROCHURE.

For years of trouble-free enjoyment all Basic Technology products use top quality components and are backed by a full 180 day parts and labor warranty. We service what we sell!!!

Add \$5 shipping & handling for BT-1000, \$2.50 for BT-1020. Michigan residents add 4% sales tax. Shipping & handling for residents of Canada, Hawaii, Alaska is \$10. Overseas orders add 15%. Check, money order, VISA, MC (give account no., expiration date, phone no.). Personal checks allow 2-3 weeks to clear. COD charge \$2 (requires certified check or money order).

**basic** Dept. Q P.O. Box 511 Ortonville, MI 48462  
**TECHNOLOGY** (313) 627-6146

*"Watch for more peripherals from  
Basic Technology."*

# Keys To Creating Winning Adventures

By Bob Liddil

**T**he Kid hunkers down over the wheel of his '57 Chevy, the floor shifter vibrating in his hand as he lightly tickles the gas pedal. The massive 427 fuel-injected engine purrs like a caged tiger begging for freedom. The Kid impatiently steals a glance at the bib overalled moonshiners as they lug the last jars of White Lightning for the run.

With the bang of the trunk lid closing, he's off! Small stones and dust fly under his wheels as he whips the stubby little car around the last dirt hairpin and onto the main highway.

But Sheriff Bubba Clemmons knows The Kid. He knows there's "shine" in the back of the car and he knows that this is going to be *The Kid's last run*. He has to stop him from making it to Klawbone.

So begins the duel.

Does this sound like a teaser from a TV movie? Actually, it's the premise for a BASIC language Adventure written for the TRS-80 by a fellow named Don Boner with the help of his daughter Freda.

Hold on, you say. Adventure is all caves and bats and dragons and wizards. Not necessarily so. Not so at all.

Although the original Adventure, *The Colossal Cave*, was all underground, the genre Adventure can be any subject under the sun. Scott Adams, Grand Poohbah of Adventure, released *Adventureland*, *Pirate's Cove*, *Mystery Funhouse* and many other all time best sellers without once touching on the "Dungeons and Dragons" thematics which dominate today's current Color Computer market.

*Strange Odyssey* is an Adventure based on overcoming an alien machine to accomplish the puzzle's solution. *Sands of Egypt* is set in a remote desert which bears little resemblance to the wizards' and warriors' worlds. *Calixto Island* employs no aspects of Fantasy Role Playing. It is possible to create brave Adventures under almost any theme at all.

Problems much more complicated than mere coding face the would-be Adventure writer. He has to choose a subject that will excite the player, make him desperate to find a solution. It must be simple, yet complicated, frustrating but satisfying and above all, it must be logical.

Here's what I believe constitutes the making of a good Adventure.

**SELECT A THEMEWORLD.** Decide what timeframe

your program will exist in and stick with it. A Fantasy World, for example, should be consistent throughout the game. One would not expect to employ laser pistols in combat against dragons. Traps should have the feeling of the period. A pit of spikes or an acid bath such as found in *Tower of Fear* is reasonable. A Cyclops, mythical or fantasy figure, which vanishes after being killed, smacks of magic. Since the tower was created by Blackheart Firethrower, ace Necromancer, to hold his treasures, we find a level of believability about the program and the things we have to do to win.

A modern themeworld such as that used in *Thunder Road* employs props one might expect. The '57 Chevy, the lady hitchhiker, Sheriff Bubba, always in pursuit, the dumb deputy's roadblock, all combine to create an atmosphere of authenticity that lends clues to the user about his next course of action.

What themeworlds could you use for an Adventure?

**FUTUREWORLD:** How about an astronaut trapped in a space lab that will soon fall from orbit? Officially, you aren't allowed to try a rescue; they don't want to risk losing you. But the trapped man is your friend and you must try to save him. Props might include a space shuttle, a magnetic ID card to activate the launch sequence, an angry guard who would have to be sedated, an oxygen bottle, necessary to save the "marooned" from suffocation in the spacewalk back to the shuttle.

**EARTH PAST:** As a gladiator in ancient Rome, you must fight your way to freedom in the arena. You are pitted against hungry lions and tigers for the edification of the crowd and you win, ingeniously, by choosing the correct weapon. But the mighty Nero has a last surprise in store for you. It is a labyrinth, a maze of corridors containing mechanical traps, enemy spearmen, deadly creatures, or politicians making speeches, all designed to inflict cruel death on you. But if you survive, all Rome will be at your feet. Can you emerge victorious?

**SPACE OPERA:** The dead space ship with just a hint of something amiss is a themeworld with many variables possible. In the classic text Adventure *Death Dreadnaught*, what is amiss unfolds slowly as the player explores the ship. Scenes of violence become increasingly evident in the form of "screen prints" on the walls or in the power room where

"once splendid engines lay fused, mutilated and useless." Of course, escape becomes imperative once the presence of the ferocious alien creature who did all this damage becomes known. Props include food batteries, a laser pistol, oxygen tank and more. There are so many different possibilities within this formula that just outlining them would take several pages. Obviously, every science fiction novel you ever read holds clues to your space opera.

The Andrea Doria, a sunken ship scenario, an ancient temple, a wild west resplendent with bandits and saloons, a cemetery with graves that turn out to be the gateway to Hades, a love boat, an island with a five-dimension stargate, a time machine, a submarine, a mysterious planet with robots guarding an ancient treasure—the divergence of the temeworlds is as universal as the imagination.

But, is it enough to have a good universe?

No.

**PLOT LOGIC** is the glue that holds all Adventures together. Each piece of the puzzle must fit neatly into the next. There must be a plausible solution for that brain teaser which halts the program in its tracks. If there are flat tires in The Kid's future in *Thunder Road*, then there had better be a reasonable way to repair them or a spare and a CHANGE TIRES command.

Adventure is an extremely Newtonian place. An author should be prepared to provide a reaction to every input. If there are too many "YOU CAN'T DO THAT" replies appearing on the screen, you can bet that player will go back to playing *The King* and not pick up your program again.

An object need not always advance the plot. A location within the theme framework need not always place the player closer to winning. But they should be interesting

diversions that enhance the overall believability of the game.

*Tower of Fear* has a room at the top of the ivy which has exasperated Adventure players since the program's debut three years ago. Once you get in, you simply *cannot* get out. It is a classic cul de sac that diverts the user's attention from his real task, that of getting into the tower. It takes awhile, but after dying 30 times in one location trying to figure an angle, one eventually goes back to the beginning and works out the right sequence. By now, the player never wants to see that stupid room again, not realizing that the author has given it a secret door cued to an obscure action to be done elsewhere in the tower.

The lesson here is to tie the objects and locations together so that individually and collectively they form a cohesive and decipherable puzzle.

**PLAYABILITY:** If you follow the rules of *plot logic*, game will be very playable. But give your user more. Give him lavish descriptions of his surroundings, being careful to consider all the things he can GET or GO to. Be intricate without being oblique, be tricky, if you're using pictures, don't be unfair. Above all, even if you're using pictures, don't be afraid to employ every application of language possible. Have your player shaking his head in disbelief when he discovers what you *really* meant when you dropped him 30 yards straight down into a dragon's lair.

When you write an Adventure, you are in every sense, creating a "compu-novel," a self-contained, well-plotted story with twists and goals and puzzles and intrigue such as to rival a book. Give your user a lean, playable, exciting Adventure and he'll be back every time you write a new one.

Now, that wouldn't be too bad at all.

**Chattanooga Choo Choo Software**

We Pay Postage!  
(In the U.S. and Canada)

Your One Stop Station  
For Computer Programs

Track 25



**Buy 1 Program Get 10% Off**  
**Buy 2 or More Programs Get 15% Off**  
Except Prickly-Pear Software (15% Off As Shown)



**\*SUPER SPECIALS\***

<p><b>Prickly-Pear Software</b> 20% OFF Disk Omni Clone \$31.95 Tape Omni Clone \$23.95 15% OFF As Shown (32K) Disk Master \$21.20 (32K) Disk Manager \$25.45 Disk Zapper \$29.70 (32K, 64K) *Vikings, *Flight (32K) \$16.95 ea. Colorkit Tape \$29.70 Disk \$33.95 Mailing List (32K) Disk \$42.45 Tee Off, Adventure In Wonderland (32K) Tape \$21.20 ea. Disk \$25.45 ea.</p>	<p><b>Computerware</b> <b>NEW Video Plus</b> Connect CoCo to composite video monitor \$24.95 <b>NEW Color Connection II</b> Tape \$29.95 Disk \$39.95 *Junior's Revenge (32K) \$28.95 Bloc Head, Doodle Bug \$26.95 ea. Grand Prix (32K), Shark Treasure \$21.95 ea.</p>	<p><b>Spectral Associates</b> Geography Pac \$32.95 Ms Gobbler (32K) Storm Arrow, Lancer (32K) Gallax Attax, Lunar Rover (32K) Ghost Gobbler, Whirly Bird Run \$21.95 ea.</p>
<p><b>Adventure Int'l</b> Arex 16K \$34.95 Fire Copter (16K) \$24.95</p>	<p><b>NEW Colorware</b> Real Talker, Disk Compatible, Hardware Voice, Synthesizer \$59.95 ea. Text to Speech Program included (16K, 32K, 64K)</p>	<p><b>Tom Mix Software</b> *Donkey King (32K) \$26.95 Space Shuttle (32K) \$28.95 Cu*ber (32K) Grabber, Frog, Buzzard Bait \$27.95 ea.</p>
<p><b>Counter Point Software</b> Early Games Tape or Disk 15% OFF As Shown \$25.45 Preschool Learning Games</p>	<p><b>NEW Intra Color</b> Colorpede \$29.95 Robottack \$24.95</p>	<p><b>Anteco Software</b> Home Expense Manager \$19.95 Stock Analysis &amp; Trend \$21.95 Pinball \$24.95 Available in Rom Pac Pinball, 8 Ball \$29.95 ea. Ghost Gobbler, Katerpillar \$25.95 ea. Whirly Bird Run, Gallax Attax \$27.95 ea.</p>

**Ask About Our Unclaimed Freight!**

\*Also available on disk (32K) at extra charge. All Programs (16K) on cassette unless otherwise stated. Send for free complete listings! TN residents add 6.25% sales tax. C.O.D. orders add \$2.00.

**(615) 875-8656 • P.O. Box 15892 • Chattanooga, TN 37415**

# A Menu Is Helpful For Choosing The Right Course

By Don Inman  
*Rainbow* Contributing Editor

If you are going to use a program more than once, proper documentation should be provided so that the program can be easily and efficiently used. The time spent on documentation will result in time saved when the program is used again. Documentation that is internal should include lots of prompts as discussed in "Using Graphics," February '83 *Rainbow*.

Menus used within a program serve a dual purpose. They not only provide ease of program use, but they also aid the programmer in writing a program that is structured by the menu selections. Menus are probably the most neglected item when programs are being written for our own use.

I'll use the graphics associated with a pie (or circle) graph to demonstrate how menus can be used. In planning a program and its main menu, you must consider how the data will be entered, how the data will be manipulated, and how the results may be used. Items on the menu should appear in the order of use whenever possible. When a selection is made from the menu, control is passed to the selected section of the program. After the necessary chores are performed in that section, a return to the main menu should be provided. Subroutines appear to be an ideal way to perform various sections selected from the main menu.

You know that specific information will be needed to draw the graph. Therefore, the first menu item might be:

**Pie Graph Menu**  
1) INPUT INFORMATION

This section will accept the information that you provide. It will also calculate and set up the necessary parameters for drawing the graph. It will then return you to the main menu.

Another section that might be desirable would be a preliminary drawing that uses the information provided in section one. You might decide upon changes after looking at the preliminary graph. We now have:

**PIE GRAPH MENU**

- 1) INPUT INFORMATION
- 2) PRELIMINARY DRAWING

After viewing the preliminary drawing, a return would be made to the main menu. If changes are needed to your original information, you would select item 1 again to make those changes.

After you have the graph drawn to your satisfaction, you may have choices as to what to do with the results, such as: send to screen, send to printer, save information on disk or tape, etc. Therefore, we add a third section.

**PIE GRAPH MENU**

- 1) INPUT INFORMATION
- 2) PRELIMINARY DRAWING
- 3) OUTPUT RESULTS

Some of us cannot sit down and plan out a complete program at one sitting. The temptation to sit down to our Color Computer and begin is just too strong. If you feel this way, you can stop at this point and decide how to program the main menu. The options for the menu placement on the screen are almost endless. *PRINT@* statements can be used to locate the text as desired. Remember, have 32 characters per line and 16 lines with the print positions numbered as follows:

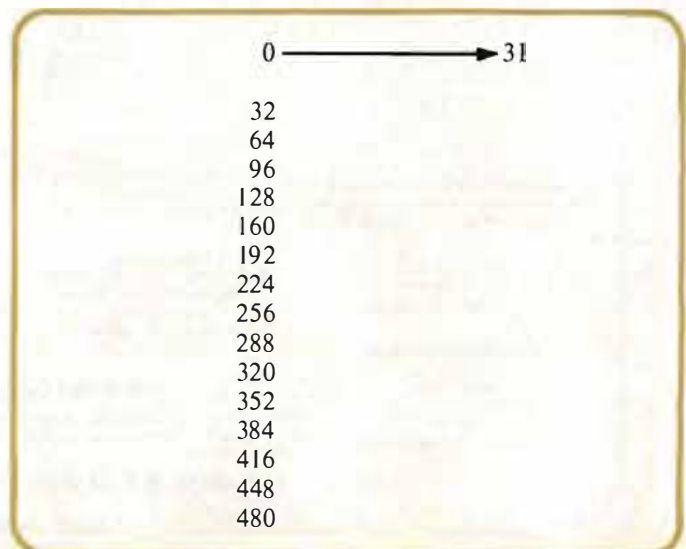

*(Don Inman is the acknowledged master of micro-computer graphics and the author of a large number of books, including "TRS-80 Color Computer Graphics" and "Assembly Language Graphics for the TRS-80 Color Computer" with Kurt Inman.)*

Most programmers seem to go to the center of the screen, but other locations can be used. Here are two options.

### PIE GRAPH MENU

- 1) INPUT INFORMATION
- 2) PRELIMINARY DRAWING
- 3) OUTPUT RESULTS

ENTER THE NUMBER OF  
THE SELECTION DESIRED

```
100 REM ** MAIN MENU **
110 CLS
120 PRINT@73,"PIE GRAPH MENU";
130 PRINT@166,"1. INPUT INFORMAT
ION";
140 PRINT@230,"2. PRELIMINARY DR
AWING";
150 PRINT@294,"3. OUTPUT RESULTS
";
160 PRINT@416,"ENTER THE number
OF";
170 PRINT@448,"THE SELECTION DES
```

```
IRED";
180 '
200 A$=INKEY$
210 IF A$="" THEN 200
220 ON VAL(A$) GOSUB 1000,2000,3
000
230 GOTO 110
240 '

```

Subroutines to be added later.

### PIE GRAPH MENU

- 1) INPUT INFORMATION
- 2) PRELIMINARY DRAWING
- 3) OUTPUT DESIRED

ENTER THE NUMBER OF  
THE SELECTION DESIRED

For this second version change the *PRINT@* values in lines 120, 130, 140 and 150 with:

```
120 PRINT@73,.....
130 PRINT@166,.....
140 PRINT@230,.....
150 PRINT@294,.....
```

## Lowest Price Ever on the Premium Keyboard—\$79.95

### Premium Keyboard—\$79.95

- Lower profile than the Professional
- Extended Radio Shack layout
- Silk-smooth feel
- All of the popular features of the Professional Keyboard

### Professional Keyboard—\$59.95

- No soldering, cutting, or gluing required—plug right in!
- New improved version—better layout, light touch.
- Four function keys complete the matrix
- Complete documentation included

### Plus!! Free Versakey Software enhances the Keyboard Utility

- Auto repeat, n key rollover, type ahead
- May define up to 128 strings of up to 80 characters each
- Supplied on cassette, may be copied to disk

Keyboards carry a 90-day limited warranty.

Include your computer's PC board type, if known.

Otherwise, include the complete catalog number and serial number.

### Micronix Systems Corporation

8147 Delmar • St. Louis, MO 63130 • (314) 721-7969

Terms: Prepaid check or money order. Mastercard of Visa.

Shipping Charges: U.S. \$3.00, COD \$5.00, Canada \$6.00.



Now that the main program is finalized, we can move on to the subroutines. We must decide what information is needed to draw a circle graph. We know we can draw a circle with the Color Computer statement:

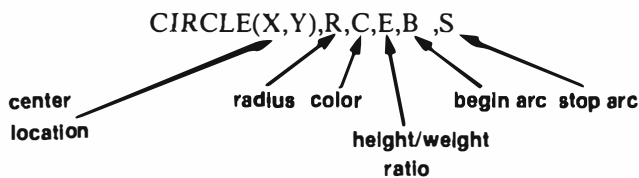

We also know we must provide the number (N) of sections into which the circle is to be divided. We certainly need to provide the X and Y values for the center of the circle and the radius (R). A problem arises when we try to find a way to divide the circle into sections. How do we locate the points

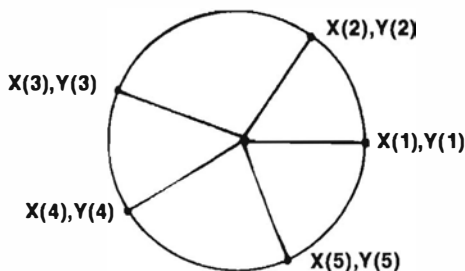

(X(1), Y(1)); X(2), Y(2)); etc. to draw the lines separating the sections? By looking at the circle diagram, you can see that X(1) and Y(1) values can be determined by:

$$\begin{aligned} X(1) &= X(0) + R \text{ and} \\ Y(1) &= Y(0). \end{aligned}$$

The other X(n), Y(n) values can be found by equations developed in the April 1983 issue of *the Rainbow* in the article "Regular Polygons." They were:

$$\begin{aligned} X(2) &= X(1) + \cos(A) * R \text{ and} \\ Y(2) &= Y(1) - \sin(A) * R, \text{ where } A \text{ is the angle between the} \\ &\text{lines drawn from the center of the circle to the} \\ &= \text{points of the circle.} \end{aligned}$$

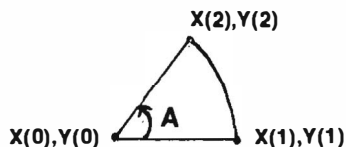

Therefore, we must provide an input that will describe the angle for each of the section dividing lines. This can be done as a percent (P) of the total circle.

```
PRINT"% FOR SECTION";Z;
INPUT P
P(Z)=P(Z-1)+P  -- add new percent to old percent
A=P(Z)*3.1416/50 -- calculate angle in radians
                  (total circle = 2 (pi) radians)
```

The complete information subroutine is:

```
1000 REM ** INPUT INFO **
1010 CLS
```

```
1020 INPUT "NUMBER OF SECTIONS";
N
1030 INPUT "CENTER OF CIRCLE (X,
Y)"; X(0), Y(0)
1040 INPUT "RADIUS OF CIRCLE"; R
1050 P(0) = 0
1060 FOR Z = 1 TO N
1070 PRINT"% FOR SECTION"; Z;
1080 INPUT P
1090 P(Z) = P(Z-1) + P
1100 A(Z) = P(Z)*3.1416/50
1110 X(Z) = X(0)+R*COS(A(Z))
1120 Y(Z) = Y(0)-R*SIN(A(Z))
1130 NEXT Z
1140 RETURN
```

After the information entries have been made in subroutine 1000, control is returned to the main program where the menu is displayed again.

The second choice, PRELIMINARY DRAWING, must be written. Assuming you have already completed the first choice, all the necessary information is stored in the computer. The second subroutine should provide a choice of PMODE, SCREEN, and COLOR (if desired).

```
2000 REM ** PRELIMINARY DRAWING
**
2010 CLS
2020 INPUT "PMODE"; M
2030 INPUT "COLOR (FORE, BACK)"; F
, B
2040 PMODE M
2050 PCLS
2060 COLOR F, B
2070 SCREEN 1, 0
2080 CIRCLE(X(0), Y(0)), R
2090 FOR Z = 1 TO N
2100 LINE(X(0), Y(0))-(X(Z), Y(Z))
, PSET
2110 NEXT Z
2120 A$ = INKEY$
2130 IF A$ = "" THEN 2120
2140 RETURN
```

Lines 2030 and 2060 are optional. The loop at lines 2090-2110 draw lines from the center of the circle to the calculated points on the circle. Lines 2120 and 2130 hold the graph on the screen until you have a chance to view the graph. Study it carefully and see if you wish to change the size or any other parameter of your drawing. Then press any key to return to the main menu.

The output section (the third choice on the menu) will largely depend upon the equipment that you are using with your computer. Here is a submenu for subroutine 3000.

#### OUTPUT OPTIONS

1. OUTPUT GRAPH TO SCREEN
2. OUTPUT GRAPH TO PRINTER
3. OUTPUT DATA

ENTER THE NUMBER OF  
THE SELECTION DESIRED



The first selection could pass control to the subroutine at 2000. The second selection would require screen print software. The third could present another submenu with options such as:

**OUTPUT DATA**

1. TO PRINTER
2. TO SCREEN
3. TO DISK
4. TO CASSETTE

ENTER THE NUMBER OF  
THE SELECTION DESIRED

Data would include the angles A(Z), and the X(Z), Y(Z) values calculated in subroutine 1000. You could also include the number of sections (N), the center of the circle X(0), Y(0), and the radius (R).

**Example:**

```
6000 REM ** OUTPUT DATA TO PRINT
ER **
6010 PRINT#-2,"NUMBER OF SECTION
S";N
6020 PRINT#-2,"CENTER OF CIRCLE"
;X(0);Y(0)
6030 PRINT#-2,"RADIUS OF CIRCLE"
;R
6040 PRINT#-2,"DATA POINTS Z;A(Z)
;X(Z);Y(Z)
6050 FOR Z=1 TO N
6060 PRINT#-2,Z;A(Z);X(Z);Y(Z)
6070 NEXT Z
6080 RETURN
```

Other sections are left for you to develop. An example of a run using the following inputs is shown.

**INPUTS**

Number of sections: 8  
Center of circle: 130, 100  
Radius 80  
% — section 1 10  
    section 2 25  
    section 3 20  
    section 4 18  
    section 5 10  
    section 6 5  
    section 7 8  
    section 8 4

**SCREEN OUTPUT**



**Printer Output**

```
NUMBER OF SECTIONS 8
CENTER OF CIRCLE 130 100
RADIUS OF CIRCLE 80
DATA POINTS Z;A(Z);X(Z);Y(Z)
1 .62832 194.721291 52.9770848
2 2.19912 82.9768469 35.2788823
3 3.45576 53.9156785 124.721975
4 4.586736 119.974193 179.369284
5 5.215056 168.541149 170.104064
6 5.529216 188.318198 154.763014
7 6.031872 207.486934 119.894098
8 6.2832 210 99.9988245
```

**Rainbow  
Check  
Plus**

1050.....01C1	235
3040.....03D4	150
5060.....05CA	131
7030.....07F8	228
END.....0994	96

**The listing:**

```
100 REM ** MAIN MENU **
110 CLS
120 PRINT@73,"PIE GRAPH MENU";
130 PRINT@166,"1. INPUT INFORMAT
ION";
140 PRINT@230,"2. PRELIMINARY DR
AWING";
150 PRINT@294,"3. OUTPUT RESULTS
";
160 PRINT@416,"ENTER THE number
OF";
170 PRINT@448,"THE SELECTION DES
IRED";
180 '
200 A$=INKEY$
210 IF A$="" THEN 200
220 ON VAL(A$) GOSUB 1000,2000,3
000
230 GOTO 110
240 '
1000 REM ** INPUT INFO **
1010 CLS
1020 INPUT "NUMBER OF SECTIONS";
N
1030 INPUT "CENTER OF CIRCLE (X,
Y)";X(0),Y(0)
1040 INPUT "RADIUS OF CIRCLE";R
1050 P(0) = 0
1060 FOR Z = 1 TO N
1070 PRINT"% FOR SECTION";Z;
1080 INPUT P
1090 P(Z) = P(Z-1) + P
1100 A(Z) = P(Z)*3.1416/50
```

```

1110 X(Z) = X(O)+R*COS(A(Z))
1120 Y(Z) = Y(O)-R*SIN(A(Z))
1130 NEXT Z
1140 RETURN
1150 '
2000 REM ** PRELIMINARY DRAWING
**
2010 CLS
2020 INPUT "PMODE";M
2030 INPUT "COLOR (FORE,BACK)";F
,B
2040 PMODE M
2050 PCLS
2060 COLOR F,B
2070 SCREEN 1,0
2080 CIRCLE(X(O),Y(O)),R
2090 FOR Z = 1 TO N
2100 LINE(X(O),Y(O))-(X(Z),Y(Z))
,PSET
2110 NEXT Z
2120 A$ = INKEY$
2130 IF A$ = "" THEN 2120
2140 RETURN
2150 '
3000 REM ** OUTPUT RESULTS **
3010 CLS
3020 PRINT@73,"OUTPUT OPTIONS"
3030 PRINT@166,"1. GRAPH TO SCRE
EN"
3040 PRINT@230,"2. GRAPH TO PRIN
TER"
3050 PRINT@294,"3. OUTPUT DATA"
3060 PRINT@416,"ENTER THE NUMBER
OF"
3070 PRINT@448,"THE SELECTION DE
SIRED"
3080 '
3100 REM ** ITEM SELECTION **
3110 A$ = INKEY$
3120 IF A$ = "" THEN 3110
3130 ON VAL(A$) GOSUB 2000,4000,
5000
3140 RETURN
3150 '
4000 REM ** OUTPUT GRAPH TO PRIN
TER **
4010 REM THIS SECTION IS LEFT FO
R YOU TO COMPLETE
4020 PRINT@0,"NOT IMPLEMENTED"
4030 FOR W=1 TO 2000: NEXT W
4040 RETURN
4050 '
5000 REM ** OUTPUT DATA **
5010 CLS
5020 PRINT@73,"OUTPUT DATA"
5030 PRINT@102,"1. TO PRINTER"
5040 PRINT@166,"2. TO SCREEN"
5050 PRINT@230,"3. TO DISK"
5060 PRINT@294,"4. TO CASSETTE"
5070 PRINT@416,"ENTER THE NUMBER

```

```

OF"
5080 PRINT@448,"THE SELECTION DE
SIRED"
5090 '
5100 REM ** ITEM SELECTION **
5110 A$ = INKEY$
5120 IF A$ = "" THEN 5110
5130 ON VAL(A$) GOSUB 6000,7000,
8000,9000
5140 RETURN
5150 '
6000 REM ** OUTPUT DATA TO PRINT
ER **
6010 PRINT#-2,"NUMBER OF SECTION
S";N
6020 PRINT#-2,"CENTER OF CIRCLE"
;X(O);Y(O)
6030 PRINT#-2,"RADIUS OF CIRCLE"
;R
6040 PRINT#-2,"DATA POINTS Z;A(Z
);X(Z);Y(Z)
6050 FOR Z=1 TO N
6060 PRINT#-2,Z;A(Z);X(Z);Y(Z)
6070 NEXT Z
6080 RETURN
6090 '
7000 REM ** OUTPUT DATA TO SCREE
N **
7005 CLS
7010 PRINT@0,"NUMBER OF SELECTIO
NS";N
7020 PRINT@32,"CENTER OF CIRCLE"
;X(O);Y(O)
7030 PRINT@64,"RADIUS OF CIRCLE"
;R
7040 PRINT@100,"Z      A(Z)   X(Z
)   Y(Z)"
7050 FOR Z = 1 TO N
7060 PRINT USING"#####.##";Z;A(Z)
;X(Z);Y(Z)
7070 NEXT Z
7080 A$ = INKEY$
7090 IF A$ = "" THEN 7080
7100 RETURN
7110 '
8000 REM ** OUTPUT DATA TO DISK
**
8010 REM THIS SECTION IS LEFT FO
R YOU TO WRITE
8020 PRINT@0,"NOT IMPLEMENTED"
8030 FOR W=1 TO 2000: NEXT W
8040 RETURN
8050 '
9000 REM ** OUTPUT DATA TO CASSE
TTE **
9010 REM THIS SECTION IS LEFT FO
R YOU TO WRITE
9020 PRINT@0,"NOT IMPLEMENTED"
9030 FOR W=1 TO 2000: NEXT W
9040 RETURN

```



# the CoCo Professional TAX PREPARER

## FOR THE INDIVIDUAL, IT ELIMINATES ANXIETY

File your taxes in confidence. The CoCo Professional Tax Preparer is accurate, thorough, and easy to use. Just answer the questions.

The CoCo Tax Preparer interviews you the way professionals in the large walk-in tax firms do. It takes you through each tax form in an organized manner. It knows which forms you need based on how you answer the questions it asks. And you can change data and make corrections - no hassle.

When you're done, the program prints your completed tax return on government-approved forms.

## FOR THE PROFESSIONAL TAX PREPARER, IT SAVES TIME

Spend your time doing what you're supposed to do. You make the important business decisions, the CoCo Tax Preparer will do the rest. And you can simplify your filing - one diskette per client.

Interview your clients in a time-saving manner and get rid of your check-off sheets.

Produce complete tax returns on government-approved forms. The CoCo Tax Preparer lets you run continuous multicopy forms in the order you need, when you need them.

### Mail to:

Micro Data Systems  
6 Edward Drive  
Ashland, MA 01721

Introductory offer: \$99 ♦ ♦ ♦  
Orders postmarked later than  
February 28, 1984: \$149.95

Mastercard  Visa  Check or Money Order Enclosed

Card # \_\_\_\_\_ Exp. Date \_\_\_\_\_

Name \_\_\_\_\_

Address \_\_\_\_\_

City \_\_\_\_\_ State \_\_\_\_\_ Zip \_\_\_\_\_

Signature \_\_\_\_\_

I need the built-in sales tax table for \_\_\_\_\_ (state).

Mass. residents add 5% sales tax. Shipped post paid. Allow two weeks for delivery.  
Yearly update available.

## PROGRAM FEATURES

Designed by a 15-year tax consultant, the program has built-in tax tables and tax rate schedules and supports the following forms:

1040  
Schedules A, B, C, D, E, G, SE, W  
Forms 2106, 2119, 3903, 4797  
Office-at-Home  
Installment Gain  
Dependency Support  
Credits and Other Taxes

**\$ 99**

For a limited time only.  
A \$400 value

## MORE FEATURES

- Over 170 full-screen menus displayed on command. Fully menu-driven screens - each appears only when required.
- Full reverse-screen scrolling and forward-screen block scroll.
- Calculator mode supports +, -, \*, /, = on numeric data.
- Edit capability: any line at any time. Supports change, delete, hack, search, and insert commands. Eliminates the need for check-off sheets
- Runs on 32K extended Basic (one disk drive with change of diskette during program execution) or two disk drives. (A special-order version runs on 64K RAM units with one or two disk drives.) Comes with diskettes and operating manual that describes each screen presentation. Additional forms are available by special order.
- Full disk drive storage for all data and computations.
- Printed output on pin-fed or tractor-fed printers, for government-approved forms.
- Its combination of machine language and Basic is fast and it minimizes memory use.



# One Graphics Screen Is Worth A Thousand Alphanumeric Characters

By Steve Blyn  
Rainbow Contributing Editor

**W**e are always looking for additional methods to help children use and learn about computers. Although many children have reached the saturation point in arcade games, many kids do not know what else to do with their computers.

One of the features that probably attracted all of us originally to the Color Computer was its graphic capabilities. This has certainly been proven true through all of the many arcade games that are now available. I, however, am much more interested in using the computer's features to enable kids to draw their own pictures.

Drawing comes naturally to many kids. The CoCo easily offers all of the features necessary to capitalize on this interest. A picture can easily be drawn and saved to tape or disk. This picture can then be recalled at any time for viewing or improvements. The improved picture can then be resaved. This is all easily handled through files.

This month's program merely scratches the surface of the world of files. Files enable us to easily save information and then reload or recall it for future use. In the December, 1983 issue of *the Rainbow*, Richard White wrote a lovely article about understanding cassette and disk file operations. His article is an excellent reference for those who wish to delve deeper into the topic.

Our plan was to create an Etch-A-Sketch program and then save the pictures that are created. Lines 110-310 create the Etch-A-Sketch. The arrow keys are used for drawing. They are the character strings numbered 8, 9, 10 and 94 on lines 150-180.

A few extra features were included for interest. The "C" key from line 190 allows the user to change and use all of the eight available colors. The "E" from lines 200 and 330 act as an eraser to improve the drawing possibilities. Pressing an arrow and the "E" key draws a blank to enable moving the cursor invisibly to a new location.

ROM locations 1024 to 1535 contain the information that is pointed on a low resolution screen. Location 1024 is the top left corner of your screen and 1535 is the bottom right corner of the screen. There are 16 lines each with 32 locations for a total of 512 locations.

The picture can then be saved by *PEEKing* those locations. The computer will then know what is there. By *POKEing* the same information back into those locations, the

computer can recreate the picture. This is how we will save and then reload the picture.

Lines 350-400 will save the picture in progress when the "S" key is pressed. A file called N\$ will be opened on line 350. The "O" refers to output; the #1 refers to disk or cassette; the N\$ refers to the original name that we gave to the picture on line 100. Lines 360-390 *PEEK* all information in the screen locations, save it in a file and then close the file.

Similarly, lines 420-480 will load from tape or disk and print on the screen all of the information that was previously saved under the particular N\$ name. The "I" in line 430 refers to input. Lines 440-470 *POKE* back in on the screen all of the parts of the picture, one location at a time.

This program can be run on cassette or disk systems. The device #-1 refers to cassette while a #1 will refer to disk. This version of the program was written for disk. Lines 350, 370, 390, 430, 450 and 480 tell the computer which device we are using. Change the #1s to #-1s on these lines if you are using cassettes.

We have used the disk version of this program with several classes of children. It was equally enjoyed by various aged students. We give a new name (N\$) to each new picture that is created. Limit the name to eight letters or less. The name is either the child's name or the type of picture that he wants to draw. Using picture subject as the name can be dangerous in a large group because when one child decides to call a picture a certain name, then others will decide on that name also. We had five pictures called "HOUSE" in one class before we realized the error. Each succeeding "HOUSE" file will wipe out the previous one on disk. You will be able to save at least 30 different pictures on a single disk. Although you can easily save this many on a cassette, the time involved in searching for each will certainly drive you to tears.

Some children are timid about using any new computer program. This program allows him to go back at a later time and rework or improve any picture that was previously started. Simply enter the name of any previous picture, use the "L" key to load it and it may be reworked and resaved time after time.

We have also used this program at home and in school as a type of picture gallery or show. Pictures are loaded one after another for evaluation or comment by the other kids. It's a lot of fun and non-threatening because the pictures can so easily be improved and resaved.

The Computer Island staff is always interested in your comments. We would love to hear how you use the programs with your youngsters.

---

*(Steve Blyn teaches both exceptional and gifted children, holds two master's degrees and has won awards for the design of programs to aid the handicapped. He and his wife, Cheryl, own Computer Island.)*

The listing:



```
10 REM"DRAWING"  
20 REM"STEVE BLYN, COMPUTER ISLAN  
D, NY, 1983  
30 CLS8:PRINT@9, "PICTURE SAVER";  
40 PRINT@98, "USE THE ARROW KEYS  
TO DRAW";  
50 PRINT@162, "USE 'S' TO SAVE TH  
E PICTURE";  
60 PRINT@194, "USE 'L' TO LOAD A  
PICTURE";  
70 PRINT@226, "USE 'C' TO CHANGE  
COLORS";  
80 PRINT@258, "USE 'E' AS AN ERAS  
ER";  
90 PRINT@290, "USE 'M' FOR MENU";  
100 PRINT@416, "WHAT IS THE NAME  
OF THIS PICTURE";:INPUT N$  
110 CLSO  
120 PRINT@480, N$;  
130 X=32:Y=16  
140 A$=INKEY$  
150 IF A$=CHR$(9) THEN X=X+1  
160 IF A$=CHR$(8) THEN X=X-1  
170 IF A$=CHR$(10) THEN Y=Y+1  
180 IF A$=CHR$(94) THEN Y=Y-1  
190 IF A$="C" THEN C=C+1  
200 IF A$="E" THEN GOTO 330  
210 IF A$="S" THEN GOSUB 350  
220 IF A$="L" THEN GOSUB 420  
230 IF A$="M" THEN RUN  
240 IF A$="" THEN 140  
250 IF X>63 THEN X=1  
260 IF X<1 THEN X=63  
270 IF Y>31 THEN Y=1  
280 IF Y<1 THEN Y=31  
290 IF C>8 THEN C=1  
300 SET (X, Y, C)  
310 GOTO 140  
320 REM"THE ERASER IS HERE"  
330 RESET(X, Y):GOTO 140  
340 REM"SAVE THE PICTURE IN A FI  
LE HERE"  
350 OPEN"O", #1, N$  
360 FOR Z= 1024 TO 1535  
370 PRINT#1, PEEK(Z)  
380 NEXT Z  
390 CLOSE #1  
400 RETURN  
410 REM"LOAD THE FILE FOR THE PI  
CTURE HERE"  
420 CLSO:PRINT@480, N$;  
430 OPEN"I", #1, N$  
440 FOR Z=1024 TO 1535  
450 INPUT#1, A  
460 POKE Z, A  
470 NEXT Z  
480 CLOSE#1  
490 RETURN
```

## HOMEBASE™ THE COMPLETE TRS-80\* COLOR COMPUTER DATABASE

HOMEBASE™ PROVIDES WORD PROCESSING, DATA-BASE MANAGEMENT, AND SPREAD SHEET CALCULATIONS, IN ONE EASY TO USE PACKAGE. SOME OF THE MANY USEFUL APPLICATIONS OF HOMEBASE™ INCLUDE:

• Check book management • Ledgers • Grocery lists • Shopping lists • Article indexing • Recipes • Disk directories • Notes • Memos • Letters • Phone lists • Customer lists • Business contact lists • Appointments • Mailing lists • Home inventory • Car maintenance scheduling • Income tax preparation • Address lists • Charts • Newsletters • Athletic team records • Form letters •

### WORD PROCESSING FEATURES INCLUDE:

- DEFINE 250 screens of text you can search, sort, display, or print using names you assign or using any word or phrase.
- EDIT text by duplicating, moving, clearing, searching and replacing, deleting, or reordering entire records of text or any word or phrase.
- FORMAT labels, memos, letters, and other documents for printing with embeded printer controls for paging, skipping lines, and changing character fonts. Program controls provide setting; right and left margins, lines per page, page width, horizontal tabs, and line spacing.

### DATA MANAGEMENT FEATURES INCLUDE:

- DEFINE 50 data fields, including a comment field, in a single record. Dates, time of day, phone numbers and dollar amounts are automatically formatted. You may also define 24 scratchpad data fields.
- REORGANIZE records by moving data fields within records or by moving records within the file. You may sort records using names you assign or data.
- MANAGE files by searching, deleting, clearing, duplicating, and displaying any data field or record. Add, subtract, multiply, divide, or summarize any data field. Use any command on any selected group of data fields and/or records.
- PRINT files using automatic formatting with options to print report titles, a report date, page numbers, record names, and data field names. Print all or selected data fields or records. Use standard or compressed print. Use a special print option to print the comment field as a mailing label.

### UTILITIES FOR WORD PROCESSING AND DATA MANAGEMENT INCLUDE:

• Generating new files from old files • Merging files • Duplicating files • Moving data between files • Summarizing files • Moving files from diskette to diskette using one drive • Saving files to cassette and reloading from cassette • File synchronizing • Print disk directory •

### HOMEBASE™ IS EASY TO USE:

- NO PROGRAMMING REQUIRED. All options are displayed in menus. HOMEBASE™ automatically requests all required data and edits every entry.
- All commands are single key stroke.
- FULL screen editing for text entry.
- Complete cursor control for entering names, titles, notes, and comments.
- 100 pages of instructions with complete descriptions of each command, and examples.
- Requires 32K of memory, disk basic and only one disk drive. NO equipment modifications required.
- All programs reside entirely in memory.
- Fast response to all commands including search and sort.

### ORDER TOLL FREE

Credit card holders call toll free: 800-334-0854 extension 887  
In North Carolina Call 800-672-0101 extension 887  
or send a check or money order for \$75.00 plus \$5.00  
for handling charges to:

HOMEBASE™ COMPUTER SYSTEMS  
P.O. Box 3448

Durham, N. C. 27702

N.C. residents add 4% for sales tax. Allow 1 to 3 weeks for delivery.

HOMEBASE™ is a trademark of HOMEBASE™ COMPUTER SYSTEMS,  
a subsidiary of Small Business Systems, Durham, N.C. (919) 544-5408.  
\*TRS-80 is a trademark of Tandy Radio Shack Inc.

# Microcomputers:

# BIG

## Isn't Always Better

By Michael Plog, Ph.D.  
Rainbow Contributing Editor

A few weeks ago, I was invited to tour a large mainframe computer complex. There were five mainframes at the site, with over 300 disk (not diskette) drive units. These are the large boxes that house rigid disks about eighteen inches across. They are filled with an inert gas, and the disk head rides a few thousandths of an inch above the surface. Some of the newer disk units contained a googolbyte of memory. A googol, by the way, is the number one followed by one hundred zeros. That's more data than the Color Computer can handle, but we are talking about mainframes.

Sidetrack — The mathematician Edward Kasner coined the term for this extremely large number, when he asked his nine-year-old nephew for an appropriate name. The boy came up with "googol" and it was accepted. See, you can learn something in an education column.

Well, back to the story. Another of the units was for mass storage. This is a device that records information on tape, much the same as my little computer. This tape, however, is four inches wide and one hundred feet long. One such spool of tape holds one hundred million bytes of storage. A robot arm gets the correct spool from a honeycomb type wall, loads the data into temporary disk space, and makes it available to the user. No human hands need (or could)

---

*(Michael Plog received his Ph.D. degree from the University of Illinois. In addition to his work as an educational researcher, he is a major partner in the Center for Opinion Research, a firm conducting state-wide polling in Illinois. The Color Computer is used in all phases of the polling work.)*

handle the mass storage tapes. Of course, there were the regular computer tapes on hand — several thousand of the large reels you see in the movies.

During the tour, I was shown several hundred modem lines connecting the different mainframes to users all across the city and state. They even had a fast printer there, 21,000 lines per minute. The biggest problem, understandably, with the printer is keeping boxes of paper in it. It takes more time to change the paper than to go through an entire box.

The total value of the equipment in this location is six hundred million dollars. Naturally, security precautions were extreme. The electric backup system alone was a complicated process. Batteries could continue the work of the computers for two hours, in case of a power failure. Then, a kerosene generator can take over. There is enough kerosene in the tanks for two weeks.

I admit it, I was thoroughly impressed by all this power and the sheer size of the computers. A friend of mine arranged the tour, probably just to impress me. He is a mainframe programmer, and can make the large machines do just about anything except walk. He wanted to show me what a "real" computer was like.

Well, I got home and had a little work to do on my Color Computer. I had to finish a short program to calculate something or other; prepare a word find game for students in my wife's classroom; and write a letter to a relative. When I sat down in front of my little machine, it did appear puny. The printer seemed to take forever to get through one page. Searching through my floppy diskettes somehow took longer than normal.

Somewhere in the middle of my work, however, I developed a deeper appreciation for the microcomputer. There was no sudden flash of realization on my part; just that I understand better the true value of a microcomputer compared with a mainframe. And you know what — a great deal of that value relates to public education in the United States!

# GER

Yes, dear reader, you knew all along I was going to get around to education, didn't you. To be truthful, I did not realize the experience of the mainframe tour related to education. (Other than my own acquisition of information.)

The mainframe represents sheer power. Generally, that translates to most of us as importance. I know that many writers have spoken against the concept of "big is better," to the point that the words are seldom used today. Yet, the emotion is still present.

For educational purposes, too much power can be negative! The huge capabilities from a mainframe computer may not be as helpful to students (and teachers, administrators, etc.) as a smaller machine. There are several reasons for this, only a few of which will be addressed here.

First is the difference between education and training. Training can be seen as knowing *why* something works. It is foolish to expect anyone other than a highly trained technician to know much about a mainframe computer. With the microcomputer, however, even small children can learn about them. Students in junior high school can learn more about electronic theory than many adults will ever know—simply because of the motivation of the microcomputer.

Of course, the expense is a major problem. Most school districts simply cannot afford a mainframe. Those that have the capability to rent time on a mainframe often have higher priorities for the money. Schools, however, can usually locate enough funds for microcomputers.

Closely tied with the issue of money is the educational value of "close-up" experience. When I was a graduate student, I dealt with a mainframe computer. During all that time, I never actually saw the computer. I passed typed cards through a half door to a bored operator, who fed them into a card reader. I received a printout from another bored operator. Most computer programmers today do not ever get close to the computer. They work with terminals mostly. Adults can handle this separation of relationship (in truth, a cause and effect separated by distance and time). Children, however, need a closer tie to understand the relationship between their actions (keying something into a machine) and the results (getting something out).

Microcomputers are more appropriate to students, just because they are smaller, more manageable. Micros encourage a greater reliance on self; something all schools should strive for.

It appears that educators have indeed received the message that micros are important to schooling. As of January, 1983, over half (53 percent) of schools in the United States had at least one microcomputer! The data on this subject is naturally old, even by the time it is collected. By now, a greater percentage of schools own microcomputers. This is certainly a milestone. Just think, students in a majority of schools in the country have access to a microcomputer. There is a string attached, however.

Micros are not owned equally across schools. Elementary schools in the south tend to be less computer-oriented than elementary schools in the rest of the country. Poorer communities tend to have elementary schools without microcomputers. And non-public schools tend not to have microcomputers. Now this is not surprising. Schools in poorer communities tend to have less of everything — including microcomputers.

Secondary schools in all areas of the country and social strata tend to have microcomputers. True, poorer schools tend to have less access for students to microcomputers than do schools in more affluent areas, but the access is there.

In the not too distant future, the work force will be more computer-oriented than now. Those students missing an opportunity to learn about micros now will find themselves at a disadvantage when they try to compete with students from more enlightened school districts. We are putting a greater disadvantage on those students who can least afford an extra handicap.

The major uses of microcomputers in the schools is predictably programming instruction and "drill and practice." In almost all cases, above average students have more access to microcomputers than do their peers with lower grades.

These findings are provided by the Johns Hopkins University, Center for Social Organization of Schools. The Center conducted a national survey of school uses of microcomputers. If you are interested in the entire report, you might try writing the Center at 3505 N. Charles St., Baltimore, MD 21218. I cannot guarantee they will respond.

The Color Computer is not the bellweather machine in schools. (You knew that already.) Those of us who have seen the truth in equipment are not totally out of the picture. More and more educational software is being prepared for the Color Computer. By next month (March, 1984) the Minnesota Educational Computing Consortium (MECC) should have twenty programs available for the Color Computer. This group is one of the largest not-for-profit producers of microcomputer software. To get more information, you can write MECC at 3490 Lexington Avenue North, St. Paul, Minnesota 55112, or call at 612/638-0600. I can almost guarantee they will respond. Even if you cannot use most of the MECC software on your Color Computer, you might still be able to use some of the MECC printed material about microcomputers.

Talk to you next month. Until then, remember that the best way to help education is to keep learning.

# A Most Dangerous Mission

By Jason Nannen

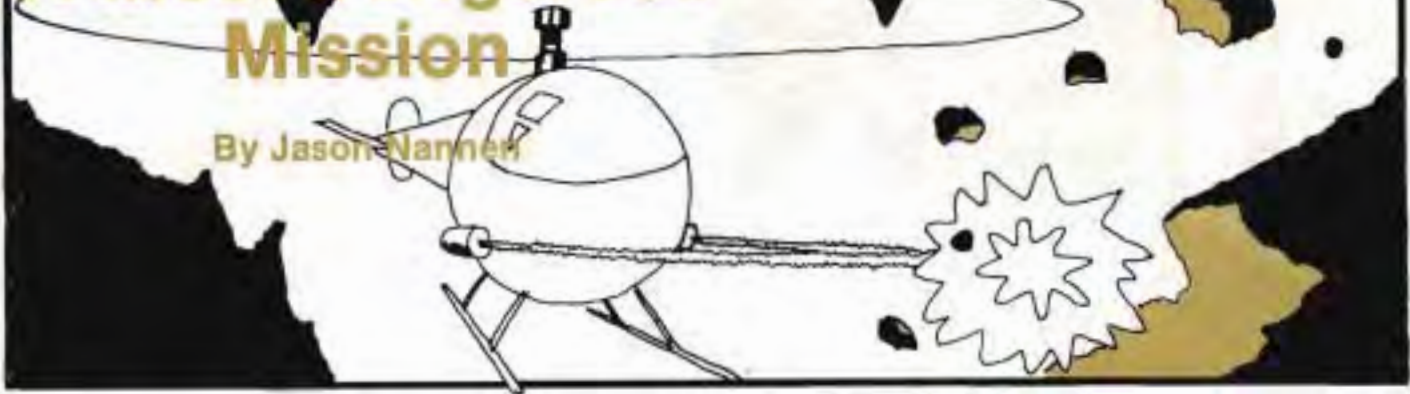

You are the pilot of an ultramodern helicopter on a mission to recover a precious artifact which, in ancient times, was stolen from your land and hidden in a series of treacherous caverns. As you maneuver your copter through the caverns, you avoid deadly stalactites and stalagmites, and dodge fearsome creatures that suddenly materialize before your copter. As a last resort you fire your powerful laser, clearing a path to safety. If you're skillful you may even collect chunks of gold that line the caverns. At last you reach the cavern of the artifact — the ultimate challenge!

*(Jason Nannen, a junior at Wethersfield [Conn.] High School, enjoys programming both games and practical programs for the CoCo. He is interested in the field of psychology and its application to artificial intelligence.)*

Yep, that's you when you play *Cavern Copter*, an arcade-type game for the CoCo. Detailed instructions are included in the program listing, but if you don't want an instructions option, exclude lines 106-395.

*Cavern Copter* can be a fairly diverse game. The five variables in lines 14-18 determine the difficulty of different parts of the game. They are explained in the listing and may be changed to modify the game to your own level of skill. Experiment!

For neat visual effects, there are three unique routines: a cavern-generator, a spiral explosion when the copter crashes, and instructions that scroll across the screen from right to left. If you include instructions, be sure to leave a space before the last quotation mark in each line of data, as in the listing. Otherwise, unwanted characters will trail when the instructions cross the screen.

Hop in your copter and hit the caverns!

Rainbow  
Check  
Plus

80	....	02B9	102
180	....	0580	226
240	....	0844	177
430	....	08D9	135
680	....	0E02	27
760	....	10D9	114
885	....	1289	53
END	...	1437	217

The listing:

```

1 '
3 '      CAVERN COPTER
5 '      BY JASON NANNEN
7 '
10 CLEAR500
11 'PLAYER CAN MODIFY GAME
    BY CHANGING THE
    FOLLOWING VARIABLES:
12 'S =BEGINNING CAVERN (0=LAST)
    AS=MAX LENGTH OF STALACTITES
    JS=MANEUVERABILITY OF COPTER
    GL=GOLD RANGE TO MIDSCREEN
    DR=CREATURE FREQUENCY
14 S=15
    
```

```

15 AS=72
16 JS=2
17 GL=60
18 DR=15
19 Z=RND(-TIMER)
20 CL=RND(8):IF CL=4 THEN 20 ELS
E CLSCL:FOR Z=103 TO 167 STEP 32
:PRINT@Z,STRING$(17,191);:NEXT
30 PRINT@137,"cavern";CHR$(128);
"copter";:POKE 1167,32
32 FOR Z=1 TO 40
33 PLAY"T12001V30"
35 PLAY"CDP"+STR$(RND(10)+30)
37 I$=INKEY$:IF I$="" THEN NEXT
40 DIM C(15,7),CB(15,7),DD(7,5)
50 PMODE 3,1:PCLS
60 CIRCLE(29,26),4,3,.9
80 DRAW"C3BM32,22L8BM-3,+2NU1NR1
NL2D2R4BM+0,+3R7C4"
92 LINE(150,150)-(158,156),PSET,
BF
94 PRESET(152,152):PRESET(156,15
2)
    
```



```

96 DRAW"C1BM152,155U1R4D1"
100 GET(16,22)-(32,29),C,G
102 GET(100,100)-(116,108),CB,G
104 GET(150,150)-(158,156),DD,G
105 S=S*2+8
106 IF CN>0 THEN 400
110 PRINT@323,"WANT INSTRUCTIONS
? (Y/N)";
120 I$=INKEY$:IF I$="" THEN120
125 PRINT@323,STRING$(25,143+16*(
CL-1));
130 IF I$<>"Y" THEN 400
140 FOR Z=290 TO 356 STEP 32:PRI
NT@Z,STRING$(28,191);:NEXT
150 READ D$
160 IF D$="ZZZZ" THEN 395
165 D$=STRING$(26,32)+D$
170 FOR Z=1 TO LEN(D$):PRINT@324
,MID$(D$,Z,24);
173 FOR ZZ=0 TO JOYSTK(0):NEXT
177 NEXT:GOTO 150
179 DATA "USE THE JOYSTICK TO CO
NTROL THE SPEED OF THESE INSTRUC
TIONS..."
180 DATA "YOUR MISSION IS TO REC
OVER A HIGHLY PRIZED ARTIFACT WH
ICH WAS STOLEN FROM YOUR LAND LO
NG AGO BY THE CREATURES THAT INH
ABIT THE CAVERNS OF KHADESHE. "
200 DATA "THE IMPERIAL WIZARD HA
S DETERMINED THAT THE ARTIFACT I
S HIDDEN IN THE MOST REMOTE CAVE
RN WHICH IS EGG-SHAPED AND IS VE
RY WELL GUARDED BY THE CREATURES
. "
210 DATA "YOU ARE EQUIPPED WITH
A HELICOPTER AND CAN CONTROL ITS
VERTICAL MOVEMENT. "
220 DATA "IF YOUR COPTER CRASHES
INTO ANYTHING RED, BE IT CAVERN
OR CREATURE, YOU WILL DIE. "
230 DATA "HOWEVER, YOU MAY BE AB
LE TO SAVE YOURSELF FROM DESTRUC
TION BY USE OF YOUR LASER. PRESS
THE FIRE BUTTON AND THE BEAM WI
LL DESTROY EVERYTHING IN ITS PAT
H. "
235 DATA "YOU HAVE THREE LASERS
FOR THE ENTIRE MISSION, BUT YOU
CAN'T USE ANY IN THE LAST CAVERN
. "
240 DATA "BUT WAIT-- THERE'
S SOMETHING GOOD ABOUT THE CAVER
NS-- THEY'RE LINED WITH G-O
-L-D !"
250 DATA "TO GET A CHUNK OF GOLD
, WHICH LOOKS LIKE A PLUS SYMBOL
(+), RUN INTO IT WITH THE front
OF YOUR COPTER. THERE IS MORE G
OLD IN THE FARTHER, MORE DIFFICU

```

```

LT CAVERNS. "
260 DATA "WHEN YOU GET A CHUNK O
F GOLD, YOUR SCORE WILL INCREASE
BY THE NUMBER CAVERN YOU ARE IN
. FOR EXAMPLE, IF YOU GET A CHUN
K IN CAVERN 8, YOU ARE AWARDED 8
POINTS. "
270 DATA "WHEN YOU GET TO THE EG
G-SHAPED CAVERN WHERE THE ARTIFA
CT LIES, THERE WILL BE HORDES OF
CREATURES. "
280 DATA "TO GET THE ARTIFACT, U
SE THE SAME METHOD AS YOU USE TO
GET THE GOLD. IF YOU DO GET THE
ARTIFACT, YOU WILL BE AWARDED 5
00 POINTS AND YOU WILL BE INSTAN
TLY TELEPORTED BACK TO YOUR LAND
. "
290 DATA "IF YOU DO NOT GET IT,
YOU WILL DIE BECAUSE YOUR COPTER
WILL CONTINUE INTO THE WALL OF
THE CAVERN. "
300 DATA "good luck "
310 DATA "ZZZZ"
395 FOR Z=290 TO 356 STEP 32:PRI
NT@Z,STRING$(28,143+16*(CL-1));:
NEXT
400 CN=CN+1
410 SCREEN0,0
420 PRINT@266,,:PRINT USING"CAVE
RN ####";CN;
430 PRINT@330,,:PRINT USING"SCOR
E #####";SC;
435 S=S-2:IF S<8 THEN 900
440 PCLS:COLOR4,1
450 LINE(0,0)-(0,RND(10)+5),PSET
460 FOR Z=S TO 255 STEP S
470 A=RND(AS)+10
480 LINE-(Z-S,RND(10)+5),PSET
490 LINE-(Z-S/2,A),PSET
500 NEXT
510 LINE-(255,RND(10)+5),PSET:PA
INT(128,0),4,4
520 LINE(0,191)-(0,RND(10)+175),
PSET
530 FOR Z=S TO 255 STEP S
540 A=RND(AS)+100
550 LINE-(Z-S,RND(10)+175),PSET
560 LINE-(Z-S/2,A),PSET
570 NEXT
580 LINE-(255,RND(10)+175),PSET
590 PAINT(128,191),4,4
600 FOR Z=1 TO CN*2
610 IF RND(2)=1 THEN Y=RND(GL)+1
5 ELSE Y=RND(GL)+175-GL
620 CIRCLE(RND(256)-1,Y),3,2
630 NEXT
640 SCREEN1,0
650 Y=90:X=-X*2
660 X=X+6:IF X>236 THEN 400

```

```

669 DUMMY=JOYSTK(0)
670 Y=Y+((INT(JOYSTK(1)/10))-3)*
JS
680 PUT(X,Y)-(X+16,Y+7),C,PSET
690 IF RND(DR)=1 AND X<170 THEN
XL=RND(36)+X+40:YL=Y+2:PUT(XL,YL)
)-(XL+8,YL+6),DD,PSET:PLAY"04T25
5V31BDAEGF"
700 IF PPOINT(X+18,Y)=4 OR PPOIN
T(X+18,Y+8)=4 OR PPOINT(X+4,Y-1)
=4 OR PPOINT(X+8,Y-1)=4 OR PPOIN
T(X+12,Y-1)=4 OR PPOINT(X+6,Y+8)
=4 OR PPOINT(X+12,Y+8)=4 THEN 77
0
710 FOR V=0 TO 8:IF PPOINT(X+20,
Y+V)<>2 THEN NEXT V:GOTO752
720 FOR Z=1 TO 8 STEP2:CIRCLE(X+
20,Y+V),Z,2:NEXT:SCREEN1,1
730 PLAY "T20003V5;1;V7;2;V9;3;V
11;4;V13;5;V15;6;V17;7;V19;8;V21
;9;V24;10;V29;11;V3104CCC"
740 SCREEN1,0:FOR Z=1 TO 8 STEP2
:CIRCLE(X+20,Y+V),Z,1:NEXT
750 SC=SC+CN:IF CN=500 THEN GOSU
B960:GOTO850
752 LA=PEEK(65280):IF F=3 OR (LA
<>254 AND LA<>126) THEN 760 ELSE
F=F+1:FOR Z=1 TO 3:PLAY"T10001V
21C05D":NEXT

```

```

753 FOR Z=15 TO 270-X STEP 2
754 IF Z<255 THEN CIRCLE(X+8,Y+4
),Z,2,.3,.96,.05
755 IF Z>22 THEN CIRCLE(X+8,Y+4)
,Z-8,1,.3,.96,.05
756 NEXT Z
757 LINE(255,Y-25)-(255,Y+25),PR
ESET
760 PUT(X,Y)-(X+16,Y+7),CB,PSET:
GOTO660
770 DRAW"BM"+STR$(X+8)+", "+STR$(
Y+4)+"C2NU8NE6NR8NF6ND8NG6NL8NH6
"
780 PLAY"T20001V31BBBV25AAAV20GG
GV15FFFV10EEEV5DDDDCCC
784 B=0:GA=(RND(15)+5)/100
785 FOR Z=1 TO RND(20)+20
795 B=B+GA
805 IF B>1 THEN B=B-1
815 CIRCLE(X+8,Y+4),Z,RND(3)+1,1
,B,B+GA
825 NEXT
845 DI=1
850 PRINT@336,,:PRINT USING"####
#";SC;
860 IF DI=1 THEN PRINT@394,"YOU
DIED !!";:PRINT@448,"";:PLAY"V31
01T1EC":GOTO980
870 PRINT@384," YOU RECOVERED T
HE ARTIFACT!
880 PLAY"02V31T6CP4CCCP15T1G"
885 PRINT" THE EMPEROR CONGRATUL
ATES YOU!
890 PLAY"P15T7GGT4AFA03T3CP20002
T5CP250CP25OCT1C"
895 FOR Z=1 TO 1000:NEXT:GOTO980
900 DR=1:CN=500:F=3
905 PCLS:COLOR4,1
910 CIRCLE(128,96),120,4,.65
915 PAINT(0,0),4,4
920 LINE(0,76)-(40,116),PRESET,B
F
925 COLOR2,1
943 LINE(188,158)-(196,162),PSET
,BF
947 DRAW"C1BM190,160R2NU1ND1R2"
950 GOTO640
960 ZZ=1:FOR Z=10 TO 190 STEP 8
965 ZZ=ZZ+.5
970 CIRCLE(X+8,Y+4),Z,2,1,.55,.5
77
975 PLAY"T4005V31;"+STR$(INT(ZZ)
)
977 NEXT:RETURN
980 PRINT@455,"PLAY AGAIN? (Y/N)
";
985 I$=INKEY$:IF I$="N" THEN CLS
:END:ELSE IF I$="Y" THEN RUN ELS
E 985

```

## THE SOFT SHOP

"For all your personal computer needs"

64K Ram Chip Set .....	\$ 59.95
Super Pro Keyboard Kit .....	65.95
Botek Interface .....	65.95
Prowriter Printer (8510A) .....	379.95

We carry Disk Drivers and Printers for the Color Computer.

### -- ARCADE ACTION --

	TAPE	DISK
The King (Tom Mix) .....	(32K) 22.95	26.95
Zaxxon (Datasoft) .....	(32K) 30.95	35.95
Buzzard Bait (Tom Mix) .....	(32K) 26.95	29.95
Fyr-Draca (ColorQuest) .....	(16K) 22.95	27.95
Colorpede (Intracolor) .....	(16K) 29.95	32.95

### \*\* For the serious Coco user \*\*

	ROMPK	DISK
OS-9 Operating Sys. ....	(64K) --	64.95
VIP Writer (Softlaw Corp) ..	(16K) 55.95	55.95
VIP Terminal (Softlaw Corp) ..	(16K) 45.95	45.95
Super Screen (Mark Data) ..	(16K) 27.95	30.95

Call or write for a catalog

We have Learning Aides for all ages. CALL!

**Terms:** Money Orders and Personal checks welcome (Please allow 2 weeks for personal checks).

**Shipping:** \$2.50 for Software, 2% for Hardware.

**C.O.D.:** Please add \$3.00 - S.C. residents add 4% sales tax.

**Handling:** Handling charges will be added for orders outside the continental U.S.

VISA and MASTERCARD ACCEPTED.

## THE SOFT SHOP

P.O. Box 878 Mauldin, S.C. 29662  
10 A.M. (803) 288-6983 8 P.M.

**Have you heard about our new**

# **EDUCATIONAL SOFTWARE LICENSE PLAN**

**for  
public and private schools?**



Max Jerman

The complete set of quality instructional software that was formerly available only at retail prices is now available to schools at less than **5%** of its current retail price.

This award-winning software is either now or soon will be running on Apple, Atari, Commodore 64, IBM-PC, TRS-80, and TRS-80 Color Computers.

Over 250 disks containing more than 1200 lessons for grades K-9 in reading, spelling, language arts, math, problem solving, math games, reading games, and programs for young learners are included in the plan.

**THE PLAN**—Schools join together to form a cost-saving consortium of 50 or more members. One school or educational agency acts as Host. The Host will receive a master set of program disks and manuals. The consortium will be licensed to make as many copies of the masters as member schools need for their various computers.

**THE BENEFITS**—Consortium schools will automatically receive updates and new program releases at no increase in membership fee. There will be no shortage of quality software for the most popular computers.

**THE COST**—Only \$250 per school per year. There is an additional start-up cost of \$250 per school to cover initial expenses. Licenses for specific computers are available to large consortia or states at reduced cost.

**ACT NOW**—Form your own consortium and contact us. Contact us directly for the names of interested schools in your area.

**At Last—A Software Solution**

**BERTAMAX INC.**  
Max Jerman, Ph.D.,  
President





# The CoCo Open

By Mike Knolhoff

## Championship Golf For The Color Computer

I'd much rather be out on the links playing golf, but up here in the north it's just too cold after the first of November. (You also tend to lose a lot of golf balls in the snow.) Usually during the winter, I just watch golf on TV and dream about hitting the little white ball. However, this year is different because I'm playing golf on my Color Computer.

*Color Computer Championship Golf* is a 16K Extended Color BASIC program that combines graphics, strategy, and a little bit of luck to make a challenging golf simulation. The program allows for up to four players. In order to properly set up the scorecard, each player's name must be kept to five letters or less. Once the player's names have been entered, the scorecard is displayed and the game begins.

Each hole is graphically displayed, and a blinking diamond identifies the ball position. On the graphic screen, the green area is the fairway, orange areas are sand traps, blue areas are water hazards, the white area at the end of the fairway is green, and all other white area is rough. The orange dot on the green is the cup, and the yardage of the hole is displayed on the screen.

Any time you are in the graphics mode you will stay there until you press the "X" key. Pressing the "X" key puts you in the text mode where you will select your club and direction of shot. The club selection screen allows you to choose a club on the basis of how far you want to hit the ball.

The number after the club name is the average distance the ball will go for that club. Next you must choose the direction you wish to hit the ball. Once you have done this, the computer will display the distance you have hit the ball based on a randomly selected percentage of the average distance of the club you selected. It also displays how much you hooked or sliced your shot based on a randomly selected distance depending on your club selection. Finally, the computer tells you where your ball has come to rest, for example fairway or sand trap. Then it's back to the graphics screen to display your new position in the hole, and you prepare for your next shot.

Once you find the green the computer takes over. The greens are divided into four "contours." Contour 1 is closest to the cup while contour 4 is farthest away. You have a better chance of one putting in contour 1, and a better chance of three putts in contour 4. But you will usually two-putt in any contour. The screen will not display your number of putts and your score for the hole, and it will be the next player's turn. Once all players have played a hole, an updated scorecard will be displayed.

Due to memory limitations on a 16K machine, there are only nine different graphic holes. These nine are repeated to make an 18-hole course. Since the graphics are in *P*MODE 1, I used the command *P*CLEAR 2 to increase the available memory to 11559 bytes. Before you begin to type in or load the program, you must perform a *P*CLEAR 2 to get enough memory. Even then after running the program there will be only a few hundred bytes of memory left.

It is not easy to break par with the program. It takes a while to get used to estimating graphic screen yardage, but as you do you will see your scores get better and better. But even when you have mastered this, an errant shot can land you in big trouble. There is quite a bit of strategy involved to position your shots to avoid water hazards and sand traps. And it's up to you to decide whether to "play it safe" or to "go for it." All in all, it may not beat playing the real thing, but it sure beats watching others play on TV.

*(Mike Knolhoff is a science teacher currently pursuing a master's degree which emphasizes computer applications in education. He has been programming for over two years and has taught BASIC and LOGO to junior high students. Mike's other interests include photography and, of course, golf.)*

**Rainbow  
Check  
Plus**

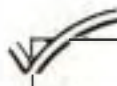

145	.....	0240	44	2260	.....	17B4	55
230	.....	0582	145	2590	.....	1A1E	118
420	.....	07F0	1	2800	.....	1CA6	213
605	.....	0AC4	185	3160	.....	1F45	77
730	.....	0D54	203	3350	.....	2161	144
925	.....	1075	171	3740	.....	23F3	252
2000	.....	131C	196	END	.....	2669	110
2135	.....	1535	169				

```
5 CLEAR500: X=RND(-TIMER)
10 DIMS(4, 18), PAR(18): A=1: DIMN$(10)
20 PAR(1)=4: PAR(2)=3: PAR(3)=4: PAR(4)=4: PAR(5)=5: PAR(6)=3: PAR(7)=4: PAR(8)=5: PAR(9)=4: PAR(10)=4: PAR(11)=3: PAR(12)=4: PAR(13)=4: PAR(14)=5: PAR(15)=3: PAR(16)=4: PAR(17)=5: PAR(18)=4
30 CLS3: PRINT@135, " COLOR COMPUT
```

```
ER ";
35 PRINT@200, " CHAMPIONSHIP ";
40 PRINT@268, " GOLF ";
45 FORK=1TO1200:NEXTK
100 CLS
120 PRINT:PRINT"HOW MANY PLAYERS
IN YOUR GROUP (NAMES MUST BE <
=5 LETTERS)":; INPUT N
125 IF N>4THENPRINT"LIMIT OF FOUR, PLEASE.":GOTO120
128 FORK=1TON
130 PRINT:INPUT"GOLFER'S NAME";NM$(K)
135 IF LEN(NM$(K))>5THENPRINT"NAME TOO LONG.":GOTO130
140 NEXTK
145 PRINT"HERE IS THE SCORECARD.":FORK=1TO600:NEXTK:GOSUB2000
155 LA$="BD4ND1OE4R2F4D1OU6NL1OB R4BU8":LR$="ND14R8F2D4G2L8R4F6BU 14BR4":LY$="BR16D2F5ND7E5U2BR4"
160 LD$="D14R6E4U6H4L6BR14":LS$="BD14R8E2U3H2L6H2U3E2R8":
165 YY$=LY$+LA$+LR$+LD$+LS$
170 N$(0)="BD4D6F4R2E4U6H4L2G4BU 4BR14":N$(1)="BR6NG4D14L4R8BR4BU 14"
175 N$(2)="BD4E4R2F4D4G3L4G3R1OB R4BU14":N$(3)="BD2E2R6F2D3G2NL5F 2D3G2L6H2BU12BR14"
180 N$(4)="BR8ND14G8R1OB4R4BU8":N $(5)="NR10D6R7F3D2G3L7BR14BU14"
185 N$(7)="R10D2G10D2BR14BU14":N $(9)="BD12F2R6E2U10H2L6G2D4F2R8B R4BU8"
190 H=H+1:ON H GOTO 200,300,400, 500,600,700,800,900,1000,200,300 ,400,500,600,700,800,900,1000
200 FORPL=1TON:GOSUB1500
202 BX=10:BY=180:X1=182:Y1=31:X2 =218:Y2=81:HX=194:HY=50
210 DRAW"BMO,180E8F12G8H12":PAINT (7,182),6,6
215 DRAW"BM11,182E40NR37U35E8OR8 OF20D20G20L65G55"
220 PAINT(128,96),6,6
225 CIRCLE(200,56),16,5,1.5:PAINT (200,56),5,5:PSET(HX,HY,8)
230 CIRCLE(175,52),9,8,2.5:PAINT (175,52),8,8
235 CIRCLE(142,95),30,7,.4:PAINT (142,95),7,7:WX=190:WY=40
240 DRAW"BM118,176C7"+N$(4)+N$(1 )+N$(4)+YY$
245 CIRCLE(BX,BY),3,7:SCREEN1,1
250 GOSUB2150:GOTO2200
300 FORPL=1TON
305 CLS:GOSUB1500
310 LINE(190,80)-(202,100),PSET, BF:BX=196:BY=90
```

```

315 CIRCLE(65,90),60,6,.6:PAINT(
70,90),6,6
320 LINE(190,90)-(120,90),PSET
325 CIRCLE(50,90),21,5,1.1:PAINT
(50,90),5,5
330 DRAW"BM75,92C8D6G14L6G4F4R10
E20U8L8BU4U8H10L6U6R10F14D10L8"
335 PAINT(78,95),8,8:PAINT(80,84
),8,8
340 PSET(58,84,8):HX=58:HY=84
345 DRAW"BM80,150C7"+N$(2)+N$(3)
+N$(1)+YY$
350 X2=72:Y2=113:X1=29:Y1=67
355 SCREEN1,1:GOSUB2150:GOTO2200
400 FORPL=1TON:GOSUB1500
410 LINE(60,10)-(80,22),PSET,BF:
BX=70:BY=16
415 CIRCLE(70,120),35,6,2:PAINT(
70,120),6,6
420 LINE(65,120)-(200,180),PSET,
BF
425 CIRCLE(185,150),35,6:PAINT(2
16,150),6,6
430 LINE(70,22)-(70,80),PSET
440 CIRCLE(185,150),16,5,1.5:PAI
NT(185,150),5,5
445 CIRCLE(86,124),10,8,1.5:PAIN
T(86,124),8,8
450 DRAW"BM154,100C7D30L8D30L8D3
0R12U22R8U30R8U38L12":PAINT(160,
106),7,7:WX=250:WY=145
455 PSET(182,156,8):HX=182:HY=15
6
460 X1=168:Y1=124:X2=202:Y2=176
470 DRAW"BM125,20C7"+N$(4)+N$(3)
+N$(5)+YY$
475 SCREEN1,1:GOSUB2150:GOTO2200
500 FORPL=1TON:GOSUB1500
510 LINE(0,100)-(12,120),PSET,BF
:BX=6:BY=110
515 LINE(12,110)-(100,110),PSET
518 CIRCLE(175,110),84,6,.55:PAI
NT(175,110),6,6
520 CIRCLE(228,110),16,5:PAINT(2
28,110),5,5

```

```

530 PSET(228,110,8):HX=228:HY=11
0
535 X2=248:Y2=130:X1=208:Y1=90
540 CIRCLE(150,110),16,8,1.8:PAI
NT(150,110),8,8
545 DRAW"BM40,20C7"+N$(3)+N$(7)+
N$(2)+YY$
550 SCREEN1,1:GOSUB2150:GOTO2200
600 FORPL=1TON:GOSUB1500
605 LINE(210,178)-(230,190),PSET
,BF:BX=220:BY=184
610 LINE(220,178)-(220,100),PSET
620 CIRCLE(220,85),30,6:PAINT(22
0,85),6,6
625 CIRCLE(100,35),100,6,.35:PAI
NT(100,35),6,6
630 DRAW"BM190,85H40E30F42":PAIN
T(190,75),6,6
635 CIRCLE(110,76),50,7,.66:PAIN
T(100,76),7,7:WX=20:WY=18
640 CIRCLE(32,35),18,5,.9:PAINT(
32,35),5,5
650 DRAW"BM52,35C8U8H10U6E4F16D2
4G16H4U6E10U8":PAINT(58,35),8,8
660 DRAW"BM10,170C7"+N$(5)+N$(1)
+N$(9)+YY$
665 PSET(36,31,8):HX=34:HY=28
670 X1=14:Y1=17:X2=50:Y2=53
675 SCREEN1,1:GOSUB2150:GOTO2200
700 FORPL=1TON:GOSUB1500
705 LINE(50,50)-(70,62),PSET,BF:
BX=60:BY=56
710 LINE(60,62)-(60,125),PSET
720 CIRCLE(60,160),60,6,.55:PAIN
T(60,160),6,6
725 CIRCLE(64,166),22,5,.45:PAIN
T(64,166),5,5
730 DRAW"BM60,152C7R26E4R2E6U4H4
U4H4L6H4L20H2L8G4L6G6L8G4L6G8F6R
2F4R8E6R8F8R8E2":PAINT(60,150),7
,7:WY=190:WX=60
735 CIRCLE(36,166),6,8,2.4:PAINT
(36,166),8,8
740 X1=40:Y2=154:X2=88:Y2=178

```

## DIRECTOR



*Director Is An Extremely Powerful Mailing List Program.*  
**Program Features**

- Operates On 32K Color Computers With 1 Disk Drive
- Saves Over 700 Addresses On Each Disk
- Permits Global Searches For Any Data Stored!
- Prints User Defined Mailing Labels
- Stores Name, Address, City, State, Zip, Phone#, And Any Additional Information Up To 64 Characters.
- Has 11 Commands, Including An Excellent Help Function
- Includes A Detailed Instruction Manual
- Cost Only \$29.95
- For More Details The Instruction Manual Is Available For \$2.00

## FINANCE-5



*Finance-5 Is A Five Part Menu Driven Program*

It Includes A Very Detailed Amortization Program, A Simple Interest Calculator, A Mortgage Payment Calculator, A Future Compound Interest Calculator, And A Commission Calculator.

All Of These Programs Produce Screen Or Printer Output. On Cassette For \$14.95 16K Extended Basic Req. Printer Optional.

### SIGMA SOFTWARE

3 Edgewood Road  
 Bryans Road, MD 20616

```

745 PSET (64, 160, 8) :HX=64:HY=160
750 DRAW"BM120,60C7"+N$(1)+N$(9)
+N$(4)+YY$
760 SCREEN1,1:GOSUB2150:GOTO2200
800 FORPL=1TON:GOSUB1500
805 LINE (242, 50)-(254, 70), PSET, B
F:BX=248:BY=60
810 DRAW"BM244,60L60H20L80G80G12
D20F12R30E82R36E20U2":PAINT (150,
60),6,6
820 CIRCLE (26, 140), 16, 5:PAINT (26
, 140),5,5
825 CIRCLE (26, 116), 12, 8, .5:PAINT
(26, 116),8,8
830 CIRCLE (50, 140), 6, 8, 2:PAINT (5
0, 140),8,8
835 PSET (22, 144, 8) :HX=22:HY=144:
X1=9:Y1=123:X2=43:Y2=157
840 DRAW"BM100,160C7"+N$(4)+N$(3)
+N$(2)+YY$
845 SCREEN1,1:GOSUB2150:GOTO2200
860 SCREEN1,1
900 FORPL=1TON:GOSUB1500
905 DRAW"BMO,10E10F6G10H6":PAINT
(2, 10),6,6:BX=8:BY=8
910 DRAW"BM10,10F70E24R150D120G1
0L40H10U70L90G20L30U20E24":PAINT
(120, 100),6,6
915 CIRCLE (150, 150), 40, 7::PAINT (
154, 150),7,7:WX=250:WY=190

```

```

920 CIRCLE (224, 166), 20, 5, .6:PAIN
T (224, 166), 5, 5:X1=202:X2=255:Y1=
142:Y2=180
925 CIRCLE (128, 96), 16, 8, .6:PAINT
(128, 96), 8, 8
930 CIRCLE (246, 144), 8, 8, 2:PAINT (
248, 154), 8, 8
935 PSET (222, 166, 8) :HX=222:HY=16
6
940 DRAW"BM100,20C7"+N$(5)+N$(4)
+N$(3)+YY$
950 SCREEN1,1:GOSUB2150:GOTO2200
1000 FORPL=1TON:GOSUB1500
1005 DRAW"BM222,18G8F12E8H12":PA
INT (224, 28), 6, 6:BX=224:BY=28
1010 DRAW"BM224,28G46L30G30L100G
10D30F10R110E50U30":PAINT (50, 120
), 6, 6
1015 CIRCLE (30, 128), 14, 5, 1.5:PAI
NT (30, 128), 5, 5
1020 PSET (32, 132, 8) :HX=32:HY=132
1025 DRAW"BM50,170C7U70E40R130D1
0L120G40D60L10":PAINT (54, 160), 7,
7:WX=20:WY=190
1030 X1=15:X2=45:Y1=106:Y2=150
1035 CIRCLE (140, 110), 8, 8, 2:PAINT
(140, 110), 8, 8
1040 DRAW"BM16,12"+N$(3)+N$(9)+N
$(9)+YY$
1050 SCREEN1,1:GOSUB2150:GOTO220

```

**Cosmos**  
COMPUTER SERVICES, INC.

112 W. WISCONSIN AV.  
KAUKAUNA, WI 54130  
(414) 766-1851

STOCK ITEMS SHIPPED SAME DAY!

THE COMPLETE TRS-80® LINE

- COLOR COMPUTER
- MODEL 100
- MODEL 4
- MODEL 16
- MODEL 12
- ACCESSORIES

THE COSMOS CONNECTION IS A COMPLETE SERIAL TO PARALLEL INTERFACE FOR THE COLOR COMPUTER TO THE GEMINI — 10 and 15 PRINTERS.



THE GEMINI—10X PRINTER AND THE COSMOS CONNECTION, IT'S A WINNING PRINTING COMBINATION.

THE GEMINI—10X PACKAGE READY TO PLUG IN TO YOUR COLOR COMPUTER ONLY\*

\$339.00  
GEMINI—10X PACKAGE

**star**  
MICRONICS, INC.

THE POWER BEHIND THE PRINTED WORD.

**WARNING:** Make sure the interface you buy does not void any factory warranties or alter the standard operation of your printer! The Cosmos Connection meets these requirements.

- NO AC REQUIRED
- SWITCHABLE BAUD RATE  
AT: 600 1200 2400
- HIGH QUALITY CONSTRUCTION
- COMPACT
- 90 DAY WARRANTY
- WORD SELECT

CALL FOR THE BEST DISCOUNT PRICE ON TRS-80® FULLY WARRANTEED MICROCOMPUTER EQUIPMENT.



TRS-80 IS A TRADEMARK OF TANDY CORP.

\*plus \$10.00 Shipping and Handling  
PRICES AND SPECIFICATIONS SUBJECT TO CHANGE.

```

0
1500 S=0:CLS:PRINT@172,"HOLE"H;:
PRINT@234,NM$(PL)" IS UP.":FORK=
1T0600:NEXTK
1505 PMODE1,1:PCLS:SCREEN0,1:COL
OR6,5
1510 RETURN
1999 H=18
2000 CLS:PRINT@33,STRING$(30,"-")
):PRINT@353,STRING$(30,"-"):PRIN
T@449,STRING$(30,"=")
2005 PRINT@0,"HOLE PAR ";:PRINTT
AB(9)NM$(1);TAB(15)NM$(2);TAB(21
)NM$(3);TAB(27)NM$(4)
2010 IFH>9THENZZ=8ELSE ZZ=-1
2020 FORK=2T010
2030 PRINT@K*32,K+ZZ:PRINT@K*32+
4,PAR(K+ZZ)
2040 PRINT@K*32+10,S(1,K+ZZ):FRI
NT@K*32+16,S(2,K+ZZ)
2050 PRINT@K*32+22,S(3,K+ZZ):PRI
NT@K*32+28,S(4,K+ZZ):NEXTK
2065 PRINT@384,"OUT--36";:PRINT@
416,"IN---36":PRINT@481,"TOTAL";
:PRINT@384,"OUT--36";
2070 IFH=10+ZZ THEN2080
2075 FORK=1T01200:NEXTK:RETURN
2080 IFH=18THEN2120
2090 PRINT@392,T(1);:PRINT@399,T
(2);:PRINT@406,T(3);:PRINT@413,T
(4);
2100 FORX=1T04:F(X)=T(X):T(X)=0:
NEXTX
2110 FORK=1T02000:NEXTK:RETURN
2120 FORX=1T04
2125 PRINT@393+(X-1)*6,F(X);
2130 PRINT@425+(X-1)*6,T(X);
2135 PRINT@489+(X-1)*6,T(X)+F(X)
;
2137 NEXT X
2138 GOTO2138
2150 A$=INKEY$:CIRCLE(BX,BY),4,7
:FORK=1T0100:NEXTK:SOUND225,1:CI
RCLE(BX,BY),4,5:FORK=1T0100:NEXT
K
2160 IF A$="X"THEN SCREEN0,1:RET
URN
2170 GOTO2150
2200 RESTORE
2201 DATA DRIVER,7 IRON,2 WOOD,8
IRON,3 WOOD,9 IRON,4 WOOD,WEDGE
1,5 WOOD,WEDGE 2
2202 DATA 1 IRON,WEDGE 3,2 IRON,
WEDGE 4,3 IRON,WEDGE 5,4 IRON,CH
IP 1,5 IRON,CHIP 2,6 IRON,CHIP 3
,7 IRON,CHIP 4,8 IRON,CHIP 5
2205 CLS:FORJ=1T012
2208 READ C1$,C2$:M$=STR$(J)
2210 PRINT@J*32,M$;" " ;C1$;(25-
J)*10,

```

```

2215 PRINTSTR$(J+12)". "C2$;(25-
(J+12))*10
2220 NEXT J:PRINT
2230 PRINT"(NO. AFTER CLUB IS AV
G. DIST.)"
2240 INPUT"WHICH CLUB (ENTER 0 F
OR HOLE)";CL:SOUND170,1
2250 IFCL=0THENSREEN1,1:GOSUB21
50:GOTO2200
2260 IF PPOINT(BX,BY)=5AND CL<8T
HENPRINT"CAN'T USE THAT CLUB FRO
M THE ROUGH.":FORK=1T0800:NEX
TK:GOTO2200
2270 IF PPOINT(BX,BY)=8AND CL<8T
HENPRINT"YOU CAN'T USE THAT CLUB
FROM THESAND."FORK=1T0800:NEXTK
:GOTO2200
2280 OX=BX:OY=BY:C=(25-CL)*10:DC
=25-CL
2300 CLS:PRINT:PRINT
2310 PRINTTAB(5)"8 1 2"
2320 PRINTTAB(5)" \!/"
2330 PRINTTAB(5)"7-X-3"
2340 PRINTTAB(5)" /!\ "
2350 PRINTTAB(5)"6 5 4"
2360 PRINT:PRINT"CHOOSE THE DIRE
CTION YOU WANT TOHIT THE BALL (O
FOR HOLE)";:INPUT Q:SOUND160,1
2380 IF Q=0THENSREEN1,1:GOSUB21
50:GOTO2300
2500 S=S+1:GOSUB4000:GOSUB4200:C
LS:A=1
2510 IFQ=1THENBY=BY-DS(A)*.54
2520 IFQ=2THENBX=BX+.4*DS(A):BY=
BY-.4*DS(A)
2530 IFQ=3THENBX=BX+DS(A)*.6
2540 IFQ=4THENBX=BX+.4*DS(A):BY=
BY+.4*DS(A)
2550 IFQ=5THENBY=BY+DS(A)*.54
2560 IFQ=6THENBX=BX-.4*DS(A):BY=
BY+.4*DS(A)
2570 IFQ=7THENBX=BX-DS(A)*.6
2580 IFQ=8THENBX=BX-.4*DS(A):BY=
BY-.4*DS(A)
2590 IF A=2THEN2700
2595 A=2
2600 R=RND(2):IFR=2THEN2630
2610 Q=Q+2:IFQ>8THENQ=Q-8
2620 GOTO2640
2630 Q=Q-2:IFQ<1THENQ=Q+8
2640 A=2:GOTO2510
2700 IFR=1THEND$="SLICED":GOTO27
20
2710 D$="HOOKED"
2720 PRINT:PRINT"YOUR SHOT WENT"
DS(1)"YARDS OUT"
2730 PRINT"AND IT "D$;DS(2)"YARD
S"
2740 IFBX<10R BX>2540R BY<1 OR B
Y>190THENPRINT"YOUR SHOT IS OUT

```



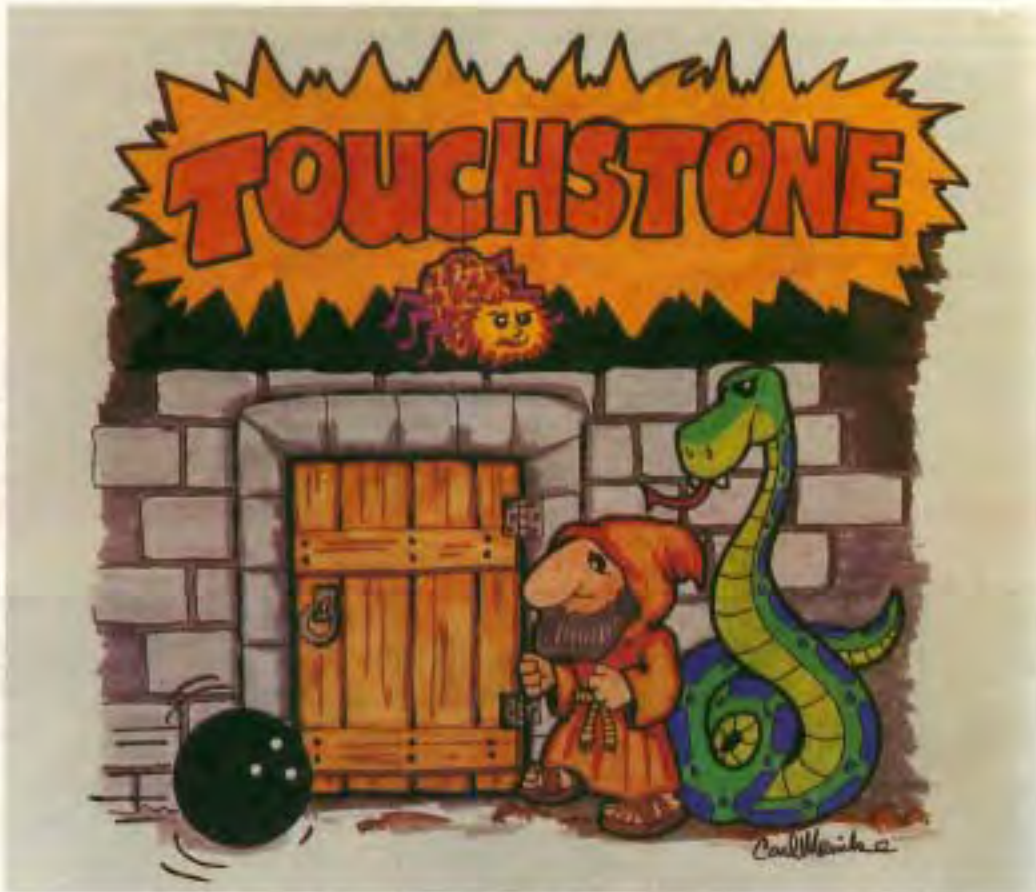

A touchstone is a test to determine the genuineness of something or of someone.

"The Touchstone" is a machine language game that runs on a 32K Radio Shack Color Computer, or any compatible hardware. Joysticks are required for play, 1 or 2 players.

You are one of many priests of Ra who has accepted the challenge of the touchstone. The challenge is a way for any of Ra's followers to become a favored high priest.

For the short time you will be in his temple, Ra will grant you limited use of his powers to help you on your challenge. As you will find, a ray of light shoots from your eyes that kills anything in your path. Also, Ra will give you a lamp filled with an elixir which when spilt, causes your enemies to freeze.

At daybreak, as you enter the temple, you hear Ra's voice reminding you of what you know so well: if you can get to the touchstone you will be highly favored. Further, he warns you that your now working powers are only temporary, and that you must be successful in the mazes to be granted more time. You enter, ready for anything. . . .

### 32K MACHINE LANGUAGE

**TAPE \$27.95**

**DISK \$30.95**



**TOM MIX SOFTWARE**

3424 COLLEGE N.E.  
GRAND RAPIDS, MI 49505

**TO ORDER**  
Call Direct 364-4791  
or 24 Hr. BBS  
(616) 364-8217  
Telex 706139

•ADD \$1.00 POSTAGE & HANDLING•TOP ROYALTIES PAID•

•MICHIGAN RESIDENTS ADD 4% SALES TAX•

LOOKING FOR NEW SOFTWARE



**ARCADE ACTION GAMES**

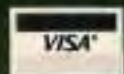

# COLORSOFT™ APPLICATIONS

## COLORSOFT™ MANAGEMENT SKILLS SERIES I: BEING BOSS

"BEING BOSS" is a collection of six programs and is the first in an ongoing series of computer assisted management development tools. Those who can benefit include corporate executives, managers, heads of teams, group leaders, supervisors, foremen, teachers, and parents. In fact, anyone who must take a leadership role can benefit from these programs.

- A. REFLECTIONS - a self evaluation guide
- B. ASSERTIVENESS - taking control as a leader
- C. MANAGEMENT STYLES - how to approach the leadership role
- D. DECISION MAKING - how to handle decision making
- E. COUNSELING - helping others solve personal problems
- F. STRESS CONTROL - taking care of yourself

Each program is in a multiple choice questionnaire format where the user is queried and is responded to specifically in management discussion. Tutorial helps the user learn new management skills and insights. The programs include voice annotation from the author, Mr. Terry Baker. "BEING BOSS" is based in part on his forthcoming management books: "BOSS TALK" and "THEORY C". The series, "BEING BOSS", offers to the user the latest in management skill development concepts and should prove to be an invaluable TOOL for anyone who wishes to reach their full potential as a leader. The author has condensed vast long intensive workshop material into this outstanding package. The accompanying user's manual is very well written and is easily understood by anyone.

Requires 16K Ext BASIC and cassette.  
PRICE \$89.95



Portfolio mgmt. and trend projections.  
16K Ext. BASIC \$21.95



Amortization schedules, auto loans, etc.  
16K Ext. BASIC \$20.95



30 expense categories with bar graphs.  
16K Ext. BASIC \$19.95

# COLORSOFT™ GAMES



Two player chase game.  
16K Ext. BASIC with joysticks \$12.95



A 3-D Graphics Adventure.  
16K Ext. BASIC \$18.95

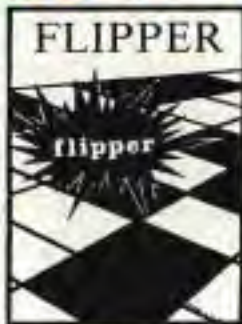

Board game, 1 or 2 players.  
16K Ext. BASIC \$16.95



Beginners Adventure  
16K Ext. BASIC \$13.95



2 player adventure.  
16K Ext. BASIC \$18.95

## GOLD LABEL™ BLANK CASSETTES



PREMIUM 5 SCREW SHELL  
COMPUTER QUALITY  
SATISFACTION GUARANTEED  
MADE IN U.S.A.  
SCHOOL/CLUB DISCOUNTS

IF YOU ARE SERIOUS ABOUT SAVING PROGRAMS AND DATA ON TAPE, THEN "GO FOR THE GOLD"

1 dozen	C-10	\$ 8.50 + \$ 2.50 shipping
2 dozen	C-10	\$ 16.00 + \$ 3.50 shipping
1 dozen	C-30	\$ 12.50 + \$ 2.50 shipping
2 dozen	C-30	\$ 23.50 + \$ 3.50 shipping

INDIVIDUAL CASSETTE STORAGE BOXES (SOLD ONLY WITH CASSETTES) \$2.40 PER DOZEN

### CASSETTE CADDY



\$ 3.95 + \$ 2.00 shipping  
2 for \$7.00 + \$ 2.50 shipping

FREE SHIPPING WHEN PURCHASED WITH CASSETTES

HOLDS 12 CASSETTES  
HINGED TOP  
STACKABLE  
EDGE LABELS INCLUDED

## ATTENTION DISK USERS

ARE YOU TIRED OF I/O ERRORS AND LOST DIRECTORY FAILURES



When these edge connectors are attached to the Disk controllers, the dreaded I/O error and lost directory failures may be virtually eliminated. The installation of these connectors DOES NOT REQUIRE SOLDERING. THESE GOLD CONNECTORS ARE SOLDERED DIRECTLY TO THE EDGE CONNECTORS OF THE DISK CONTROLLER. INSTALLATION OF THESE CONNECTORS MAY VOID THE WARRANTY ON THE DISK CONTROLLER.

KIT INCLUDES TWO CONNECTORS AND COMPLETE INSTRUCTIONS FOR EASY INSTALLATION.

PRICE: \$16.95 + \$ 1.00 shipping (Installation not included)

ASK YOUR DEALER ABOUT THEIR INSTALLATION SERVICES

CUSTOM INSTALLATION (Includes connectors): \$35.95 + \$ 4.00 return shipping

INSTALLATION AND UPS 2nd DAY SERVICE WITHIN 5 DAYS OF RECEIPT OF DISK CONTROLLER

## BRANTEX, INC.

COLOR SOFTWARE SERVICES DIV.

P. O. Box 1708  
Greenville, Texas 75401



ATTENTION DEALERS: WE OFFER THE BEST DEALER PLANS AVAILABLE

TELEPHONE ORDERS  
(214) 454-3674  
COD/VISA/MASTERCARD  
Include \$2.00 handling per order  
Write for Free Catalog

# THE COLORSOFT™ BUSINESS SYSTEM

INTEGRATED BUSINESS SOFTWARE DESIGNED FOR THE COLOR COMPUTER  
WRITTEN FOR USE BY THE NON-ACCOUNTING ORIENTED BUSINESSMAN  
CONCISE USERS MANUAL WITH SAMPLE TRANSACTIONS TUTORIAL  
PROFESSIONALLY WRITTEN AND FULLY TESTED  
HIGHLY USER FRIENDLY AND MENU DRIVEN  
AFTER THE SALE SUPPORT

**SMALL BUSINESS ACCOUNTING (Version 2.0)** This sales-based accounting package is designed for the non-accounting oriented businessman. It also contains the flexibility for the accounting oriented user to set up a double entry journal with an almost unlimited chart of accounts. This package includes Sales Entry, transaction driven Accounts Receivable and Accounts Payable, Journal Entry, Payroll Disbursement, and Record Maintenance programs. Screen and hardcopy system outputs include Balance Sheet, Income Statement, Customer and Vendor Status Reports, Accounts Receivable and Payable Aging Reports, Check Register, Sales Reports, Account Status Lists, and a Journal Posting List. The number of accounts is limited only by the number of disk drives. . . . . \$89.95

**ACCOUNTS RECEIVABLE (Version 2.0)** This package is designed to meet the requirements of most small business users. The system includes detailed audit trails and history reports for each customer, prepares invoices and monthly statements, mailing labels, aging lists, and an alphabetized customer listing. The user can define net terms for commercial accounts or finance charges for revolving accounts. This package functions as a standalone A/R system or integrates with the Small Business Accounting package to build a complete accounting/receivables system. . . . . \$59.95

**PAYROLL (Version 2.0)** This integratable package is designed for maintaining personnel and payroll data for up to 200 hourly and salaried employees with 8 deductions each. This system calculates payroll and tax amounts, prints checks and maintains year-to-date totals. These amounts can be automatically transferred to the SBA package for financial reporting. It computes each pay period's totals for straight time, overtime, and bonus pay and determines taxes to be withheld. Additional outputs include mailing list, listing of employees, year-to-date federal and/or state tax listing, and a listing of current misc. deductions. This system is suited for use in all states except Oklahoma and Delaware. . . . . \$69.95

All programs require a minimum of 32K and 1 disk drive but will take advantage of 64K and multiple drives. Each package features a hi-res 51 x 24 black on green screen. 16K versions available without hi-res screen. Specify 16K or 32K versions when ordering. Future integrated packages will include: Inventory Control, Sales Analysis, Accounts Payable.

INCLUDE \$5.00 Shipping/Handling Per Order

Write for Free Catalog

## BRANTEX, INC.

COLOR SOFTWARE SERVICES DIV.

BUSINESS SOFTWARE GROUP  
P.O. BOX 1708  
GREENVILLE, TEXAS 75401



TELEPHONE ORDERS  
(214) 454-3674  
COD/VISA/MASTERCARD

ATTENTION DEALERS: WE OFFER THE BEST DEALER PLANS AVAILABLE

```

OF BOUNDS--      LOSS OF STROKE AN
D DISTANCE.":SOUND20,5:BX=OX:BY=
OY:S=S+1:FORK=1TO1500:NEXTK:GOTO
2200
2750 IF PPOINT(BX,BY)=8 AND ABS(BX
-HX)<5 AND ABS(BY-HY)<5 THEN 3600
2760 IF PPOINT(BX,BY)=8 THEN 3000
2770 IF PPOINT(BX,BY)=7 THEN 3200
2780 IF PPOINT(BX,BY)=5 AND BX>X
1 AND BX<X2 AND BY>Y1 AND BY<Y2
THEN 3300
2785 IF PPOINT(BX,BY)=5 THEN PRINT
"YOU ARE IN THE ROUGH. A 4 IRON
IS THE LONGEST CLUB YOU CAN HIT
.":GOTO 2800
2790 PRINT"YOU ARE IN THE FAIRWA
Y."
2800 FOR K=1TO1500:NEXT K
2810 SCREEN1,1:GOSUB 2150:GOTO 220
0
3000 PRINT:PRINT"YOU ARE IN A SA
ND TRAP. PRESS enter TO SEE IF
YOU ARE NEXT TO THE GREEN.":SOU
ND 80,5:INPUT R$:SCREEN1,1:GOSUB 21
50
3010 INPUT"IS TRAP NEXT TO GREEN
";R$
3020 IFR$="YES" THEN 3100
3030 IFR$<>"NO" THEN 3010

```

```

3040 SC=RND((5)-1)*10
3050 PRINT:PRINT"YOU CAN'T USE A
NY CLUB LONGER THAN A FOUR IRON.
AVG. DISTANCES WILL BE A LITTLE
SHORTER."
3060 FOR K=1TO1500:NEXTK:SCREEN1,
1:GOSUB 2150:GOTO 2200
3100 PRINT:PRINT"RESULT OF SAND
TRAP SHOT.":S=S+1
3110 B=RND(20)
3120 IF B=1 THEN PRINT"BALL GOES IN
CUP":GOTO 3600
3130 IF B>1 AND B<4 THEN PRINT"BALL
IS ON 1ST CONTOUR.":R=RND(15):GO
TO 3460
3140 IF B>=4 AND B<8 THEN PRINT"BALL
IS ON 2ND CONTOUR.":R=RND(15):G
OTO 3430
3150 IF B>=8 AND B<15 THEN PRINT"BAL
L IS ON 3RD CONTOUR.":R=RND(15):
GOTO 3400
3160 IF B>15 THEN PRINT"BALL IS ON
4TH CONTOUR.":R=RND(15):GOTO 3370
3170 IF B=15 THEN PRINT"BALL IS STI
LL IN SAND!!":FORK=1TO600:NEXTK:
GOTO 3100
3200 PRINT"YOU ARE IN A WATER HA
ZARD!! YOUR BALL WILL BE DROPPED
BACK AND YOU WILL BE CHARGED ON
E PENALTY STROKE."
3210 SOUND 50,5:S=S+1
3220 IF BX<WX THEN BX=BX-15 ELSE
BX=BX+15
3230 IF BY<WY THEN BY=BY-10 ELSE B
Y=BY+10
3240 IF PPOINT(BX,BY)=7 THEN 3220
3250 FOR K=1TO1500:NEXTK:SCREEN1
,1:GOSUB 2150:GOTO 2200
3300 PRINT:PRINT"YOU ARE ON THE
PUTTING GREEN!!":FORK=1TO800:NEX
TK:SCREEN1,1:GOSUB 2150
3310 P1=ABS(HX-BX):P2=ABS(HY-BY)
:R=RND(15)
3320 IF P1>P2 THEN P=P1:GOTO 3330
3325 P=P2
3330 IF P<=5 THEN PRINT"CONTOUR 1":
GOTO 3460
3340 IF P<=10 THEN PRINT"CONTOUR 2"
:GOTO 3430
3350 IF P<=18 THEN PRINT"CONTOUR 3"
:GOTO 3400
3360 PRINT"CONTOUR 4"
3370 IFR=1 THEN PRINT"YOU HOLED TH
E PUTT!!":S=S+1:GOTO 3500
3380 IFR>12 THEN PRINT"YOU 3 PUTTE
D!":S=S+3:GOTO 3500
3390 PRINT"YOU 2 PUTTED":S=S+2:G
OTO 3500
3400 IFR<3 THEN PRINT"YOU HOLED TH
E PUTT!!":S=S+1:GOTO 3500

```

## speed reading \$17.95

Here's a program to help you improve your reading speed dramatically. Reading material flashes on the TV screen at the speed you select. You can even vary the speed while reading. Plus *drills* to improve visual span and perception. Speeding your reading takes dedicated effort. With this unique program, your effort will be more efficient, convenient and productive.

## wild party ~~\$35.00~~ \$27.95

A naughty, sexy computer game for 2 to 6 couples. RAINBOW: "would definitely liven up most parties."



## 29 monsters \$14.95

A text-adventure game that does not require you to guess words from its hidden collection. To escape the evil wizard's castle, you must pass through 29 rooms, each guarded by a hideous monster who will only let you pass if you can devise the correct password based on the clues it gives you.

All programs on cassette tape for 16K Color Computer. Extended BASIC not required. Send SASE for instruction sheet for any program. Prices include postage (PA resid. add 6%). Send check to P.O. Box 210, Jenkintown, PA 19046.

## b & b software

```

3410 IFR>13THENPRINT"YOU 3 PUTTE
D!":S=S+3:GOTO3500
3420 GOTO3390
3430 IFR<5THENPRINT"YOU HOLED TH
E PUTT!!":S=S+1:GOTO3500
3440 IFR=15THENPRINT"YOU 3 PUTTE
D!":S=S+3:GOTO3500
3450 GOTO3390
3460 IFR<8THENPRINT"YOU MADE THE
PUTT!":S=S+1:GOTO3500
3470 GOTO3390
3500 FORK=1TO1200:NEXTK
3510 S(PL,H)=S:T(PL)=T(PL)+S:GOS
UB3700
3520 NEXTPL
3530 GOSUB2000:GOTO190
3600 PRINT:PRINT"YOU HAVE HOLED
THE SHOT!!!":GOTO3500
3700 PRINT:PRINT"YOUR SCORE:"S(P
L,H)
3710 IF S(PL,H)=PAR(H) THENPRINT"
PAR"
3720 IFS(PL,H)=PAR(H)-1THENPRINT
"BIRDIE!"
3730 IFS(PL,H)=PAR(H)-2THENPRINT
"EAGLE!!"
3740 IFS(PL,H)=PAR(H)+1THENPRINT
"BOGEY"
3750 IFS(PL,H)=PAR(H)+2THENPRINT
"DOUBLE BOGEY"

```

```

3760 IFS(PL,H)>PAR(H)+2THENPRINT
"YECH!!!"
3770 FORK=1TO800:NEXTK:RETURN
4000 D1=RND(6):D2=RND(6):TD=D1+D
2
4010 IFTD=2THENDS(1)=C*.75
4020 IFTD=3THEN DS(1)=C*.8
4030 IFTD=4THEN DS(1)=C*.95
4040 IFTD=5THEN DS(1)=C*.85
4050 IFTD=6THEN DS(1)=C*.9
4060 IFTD=7THEN DS(1)=C
4070 IFTD=8THEN DS(1)=C*1.1
4080 IFTD=9THEN DS(1)=C*1.15
4090 IFTD=10THEN DS(1)=C*1.05
4100 IFTD=11THEN DS(1)=C*1.2
4110 IFTD=12THEN DS(1)=C*1.25
4120 DS(1)=DS(1)-SC:DS(1)=INT(DS
(1))
4130 SC=0:RETURN
4200 D1=RND(4):D2=RND(4):TD=D1+D
2
4210 IFTD=2THEN DS(2)=DC*2
4220 IFTD=3THEN DS(2)=DC*1.3
4230 IFTD=4THEN DS(2)=DC*.75
4240 IFTD=5THEN DS(2)=DC*0
4250 IFTD=6THEN DS(2)=DC
4260 IFTD=7THEN DS(2)=DC*.5
4270 IFTD=8THEN DS(2)=DC*1.6
4280 DS(2)=INT(DS(2)):RETURN

```



## ROBOT-1

**Computer Servo  
Controlled Robot Arm**

**Keyboard or Joystick  
Control;  
Plugs Into Your Co Co;  
Remembers Everything  
It Did -  
Does It Again!  
Includes All Software:  
Includes Power Supply,  
6 Channel Servo  
Controller,  
Robot-1 and Cables  
Order Robot 1-C  
\$395.00**

**Also SS-50 Version  
Available  
Order Robot-1S  
\$395.00**

**Free Catalog**

## ANALOG MICRO SYSTEMS

**5660 Valmont Road  
Boulder, Colorado 80301  
(303) 444-6809**

# All in the Family Tree

By Richard Seaberg

When my wife's family decided to have a family reunion, my wife assumed some of the responsibilities for gathering the data to be used in creating a family tree. As she and her cousins dug into the project, meeting regularly to compile their lists of names, weddings, and birth dates, etc., I couldn't refrain from offering to input the mounting data into some sort of record-keeping program I would write for my Color Computer (my wife is Italian and has quite a large family).

As it turned out, I didn't accomplish too much in terms of easing family tree research. Instead, I decided to concentrate on a novel way to present the results. In my *Family Tree* program,

all the required data is chronologically arranged and coded via *DATA* statements. The program presents one logical family "unit" at a time, waits for some predetermined interval, and then moves on to the next lateral or lower "family branch." It's designed to display its way "down" any given branch until the "tip" is reached and then revert to the next lateral family member's "limb" ... that being the next youngest child of the top-of-the-tree parents. What I actually did was bring the computer and monitor to the reunion and let it run all day (it cycles around and reruns itself) where it proved to be quite an attraction.

*(Dick Seaberg, a systems development department manager in a New England health insurance company, resides in Wallingford, CT. He and his 14-year-old son have collaborated on several family-type BASIC games which are being marketed by Spectral Associates.)*



The version here, of course, contains a hypothetical and, I hope, fictitious tree of some strange intermarriages. Since a picture is indeed worth a thousand words, I would suggest that the data statements be typed in as shown before attempting to plug in your own family. Certainly, there are idiosyncrasies in any tree and I've attempted to include a good sampling here. Once you see how it works, you'll be able to hard-code in any special flashing-divorce signs, clone-notations, reincarnations or other circumstances unique to your own family heritage.

Starting at line 40 you'll notice that each *DATA* statement has a code number of from 1 to 9 as its first entry. Each code tells the program

how to treat and display the data from the next read which, for simplicity, follows within the same *DATA* statement. For the sake of a 16K computer and ease of explanation, I'll assume the relative position (pun intended) of a grandchild to put things into perspective. Also, we'll assume that I'll be creating a tree commencing with my fraternal grandparents.

- Code 1 - My Grandfather (Full name)
- Code 2 - My Grandmother (Full name)
- Code 3 - Their wedding year

The above data will display first at screen center.

Code 4 - Their children (my father plus any aunts, uncles). First name, comma, year of birth (in order by year of birth).

There should be 11 Code 4 entries to force the grandparents' data to scroll to the top of the screen where they will remain throughout. Use additional blank statements (*DATA 4,*) if needed. If more than 11 children were born, you'll have to repeat Codes 1 and 2 entries followed by the additional Code 4s. (See lines 90-180)

- (Codes 5 and 6 exist only if a "4" married)
- Code 5 = Full name of my parent, aunt or uncle
- Code 6 = Full name of spouse of (5) above
- Code 3 = (as previously described)
- Code 4 = Their children (as previously described). This will be my family unit (myself, brothers/sisters) or aunt/uncle unit (cousins)

There is a maximum of six Code entries but no minimum. If more than six children were born, you'll have to repeat Codes 5 and 6 followed by the additional Code 4s.

Marriages and children of next generations (mine and on) are coded next similarly to last generation but with the following exception: Code 8 is used in place of Code 3. Its format is as shown in line number 350 and is used only after the first marriage of the generation. Its purpose is to display the prior generation's parent names just under the grandparents while the displays continue to the "tip" of the branch. Code 8 has another format (line 550) to blank out the prior generation's parent names. Code 9 is the last *DATA* statement and should be coded as shown.

Lines 1710-1790 are optional in that the "flag" they draw is of no known origin, but it allows for a logical place to insert your own emblem or title to dress up the running display. Line 1800 contains a waiting interval which is used between displays to allow enough time to view each screen. During preparation, you will want to shorten it to 300 or less. Key in the program as shown and save it to tape using *CSAVE FAMTREE*.

All of us have, at one time or another, probably considered gathering together certain family data such as that which this program needs in order to function. Here's your chance to follow through and have fun doing it.

	Rainbow Check Plus
240..... 0259	1
560..... 0588	94
870..... 087A	99
1170.... 0B44	35
1430.... 0DB1	136
1680.... 1016	27
END..... 1131	5

The listing:

```

5 'family tree - D. SEABERG 1983
10 PCLEAR1: CLEAR500
20 CLS
30 'two who started it all
40 DATA 1, CHARLIE HATFIELD 1883
-1955
50 DATA 2, ELLIE MC COY 1887-196
2
60 'their wedding year

```

```

70 DATA 3, 1906
80 'their offspring
90 DATA 4, ELLIE MAE, 1909-1975
100 DATA 4, JIMMY, 1911-1918
110 DATA 4, DORA, 1913
120 DATA 4, BILLY BOB, 1915
130 DATA 4, SUE ANN, 1917
140 DATA 4, ORVILLE (JIMMY), 1919
150 DATA 4, WILBUR, 1921
160 DATA 4, LEROY, 1923-1977
170 DATA 4, JERIMIAH, 1926
180 DATA 4, BILLY JOE, 1928
190 '***eleven child max
200 '****add data as follows to
210 '*****reach max else repeat
220 '****codes 1&2 to exceed max
230 DATA 4,,
240 'secd generation
250 DATA 5, ELLIE MAE HATFIELD
260 DATA 6, DRUFUS PARTON
270 DATA 3, 1930
280 DATA 4, CLEM, 1932
290 DATA 4, LORRIE MAE, 1935
300 DATA 4, BELINDA, 1939
310 DATA 4, DOLLIE, 1946
320 'thrd generation
330 DATA 5, CLEM PARTON
340 DATA 6, PRICILLA VAN DYKE
350 DATA 8, **ELLIE MAE & DRUFUS
PARTON***, 1965
360 DATA 4, BECKY MAE, 1966
370 'fourth generation
380 DATA 5, BECKY MAE PARTON
390 DATA 6, CHIG-NUK STRONGBOW
400 DATA 8, ****PRICILLA & CLEM P
ARTON****, 1983
410 DATA 4, TONTO BILLY, 1983
420 DATA 5, LORRIE MAE PARTON
430 DATA 6, HYMAN ABROMOWITZ
440 DATA 8, **ELLIE MAE & DRUFUS
PARTON***, 1953
450 DATA 4, IRVING, 1953
460 DATA 4, ZELDA MAE, 1956
470 DATA 4, MORRIS BOB, 1958
480 DATA 4, SAMUAL LEE, 1959
490 DATA 5, DOLLIE PARTON
500 DATA 6, PATRICK O'BRIEN
510 DATA 8, **ELLIE MAE & DRUFUS
PARTON***, 1968
520 DATA 4, SHAWN BOB, 1968
530 DATA 5, DORA HATFIELD
540 DATA 6, PASQUALE CAPONE
550 DATA 8, BLK, 1941
560 DATA 4, CARMILINA MAE, 1942
570 DATA 4, ROCCO EARL, 1951
580 DATA 5, CARMILINA MAE CAPONE
590 DATA 6, JESUS CAVARRO
600 DATA 8, ****DORA & PASQUALE C
APONE***, 1960
610 DATA 4, BILLY JESUS, 1962

```

```

620 DATA 4,BOBBY JUAN,1963
630 DATA 4,BELINDA ANGEL,1966
640 DATA 5,ROCCO EARL CAPONE
650 DATA 6,TRIXIE GLIK
660 DATA 3,1980
670 DATA 5,BILLY BOB HATFIELD
680 DATA 6,PAM ZYZCKSKI
690 DATA 8,BLK,1947
700 DATA 4,LAURA ANN,1948
710 DATA 4,LAURA LEE,1950
720 DATA 4,LAURA BOB,1950
730 DATA 4,LAURA MAE,1952
740 DATA 4,LAURA STAN,1953
750 DATA 4,LAURA BILLIE,1954
760 DATA 5,SUE ANN HATFIELD
770 DATA 6,SVEN OLSEN SR
780 DATA 8,BLK,1940
790 DATA 5,SUE ANN HATFIELD
800 DATA 6,SVEN OLSEN JR
810 DATA 8,BLK,1940
820 DATA 4,ELMER JOE,1941
830 DATA 4,GRETA MAE,1942
840 DATA 4,AXEL BERT,1946-1976
850 DATA 5,ELMER JOE OLSEN
860 DATA 6,CARRIE MC COY
870 DATA 8,*****SUE ANN & SVEN O
LSEN*****,1963
880 DATA 4,CORA,1965
890 DATA 4,NORA,1966
900 DATA 5,GRETA MAE OLSEN
910 DATA 6,ABDUL JEFFERSON
920 DATA 3,1964
930 DATA 4,THELMA RAE,1965
940 DATA 4,WESLEY LEE,1967
950 DATA 5,ORVILLE (JAMES) HATFI
ELD
960 DATA 6,GERLINDA VON EICHMANN
970 DATA 8,BLK,1941
980 DATA 4,GERTRUDE ANN,1941
990 DATA 4,FRITZ BOB,1944
1000 DATA 5,GERTRUDE ANN HATFIEL
D
1010 DATA 6,FRANCOIS DUPUIS
1020 DATA 8,*ORVILLE & GERLINDA
HATFIELD*,1962
1030 DATA 4,CYNTHIA EMMA,1963
1040 DATA 4,CHERYL ELLIE,1965
1050 DATA 4,RICHARD JIM,1969
1060 DATA 5,FRITZ BOB HATFIELD
1070 DATA 6,SING LING KWAN
1080 DATA 3,1968
1090 DATA 4,SHENG HO BOB,1975
1100 DATA 5,WILBUR HATFIELD
1110 DATA 6,BRUCE BOYINGTON
1120 DATA 8,BLK,1942
1130 DATA 5,JERIMIAH HATFIELD
1140 DATA 6,CARLOTTA RODRIGUIS
1150 DATA 3,1951
1160 DATA 4,JOSE JO,1957
1170 DATA 4,CARMINE RAE,1958

```

```

1180 DATA 4,CHIQUITA MAE,1960
1190 DATA 5,BILLY JOE HATFIELD
1200 DATA 6,BILLIE JO HATFIELD
1210 DATA 3,1954
1220 DATA 4,JOEY BILL,1967
1230 'next data must be at end
1240 DATA 9,END
1250 'graphic strings
1260 X$=STRING$(32,191):S$=STRIN
G$(8,191):X1$=S$+STRING$(16,32)+
S$
1270 Z$=LEFT$(X$,11)+CHR$(128)+"
children"+CHR$(128)+LEFT$(X$,11)
1280 U$=STRING$(9,143+32)
1290 T$=STRING$(8,207)
1300 W$=STRING$(14,140)
1310 R$=LEFT$(V$,30):X4$=STRING$
(16,128)
1320 V$=STRING$(31,32)
1330 'go print flag or crest
1340 GOSUB1720
1350 'main program
1360 READA:READA$
1370 ON A GOTO1380,1510,1510,155
0,1390,1390,1650,1680,1600
1380 CLS:GOSUB1610:GOTO1400
1390 GOSUB1800:GOSUB1610
1400 READA:READB$
1410 PRINT@160,X$
1420 PRINT@256,X$;:X=LEN(A$):Y=L
EN(B$)
1430 FORV=1TO X
1440 C$=RIGHT$(A$,V)
1450 PRINT@193,C$:NEXTV
1460 FORV=1TO Y
1470 C$=LEFT$(B$,V)
1480 PRINT@255-V,C$:NEXTV
1490 FORT=1TO300:NEXTT:B=A
1500 GOTO1360
1510 PRINT@256,X1$:PRINT@264,X4$
;:PRINT@265,"married";:POKE1297,
45:FORX=1TO4:X3$=MID$(A$,X,1):PO
KE(1298+X),VAL(X3$)+48:NEXTX
1520 PRINT@287,CHR$(191);
1530 GOSUB1800
1540 GOTO1360
1550 IFB<>4 THEN PRINT@256,Z$;:P
RINTTAB(1)W$;CHR$(136):GOTO1570
1560 PRINTTAB(31)" ";
1570 READD$:IFD$=""THEN 1580ELSE
PRINTTAB(1)CHR$(132);CHR$(140);"
";A$;:PRINTTAB(21)D$;
1580 B=A
1590 GOTO1360
1600 GOSUB1800:RESTORE:BB=0:GOTO
1340
1610 BB=BB+1:IFBB=2 THEN 1620ELS
E GOTO1630
1620 PRINT@96,X$;:PRINT@128,V$;
1630 PRINT@192,V$;:PRINT@224,V$;

```



# ☆☆ Elite Software ☆☆

Box 11224 • Pittsburgh, PA 15238 • (412) 795-8492

\* EXCITING NEW CONCEPT OFFERED EXCLUSIVELY BY ELITE.

- \* YOUR COMPUTER LEARNS !
- \* IT MODELS HUMAN THINKING . . . BUILDING VOCABULARY AND DEVELOPING REASONING CAPABILITIES.
- \* IT WILL ASK SOME OF THE MOST AMUSING QUESTIONS WHILE IT CREATES ITS OWN PERSONALITY.

## ARTIFICIAL INTELLIGENCE



### Guess the Animal

**GUESS THE ANIMAL**—A machine language, artificial intelligence program for the Color Computer. You must play it to believe it. Think of an animal, and this software will try to guess it using your clues. Watch this program learn, and use your clues. See it respond with questions. The longer you play, the smarter this program becomes. 16K \$19.95 Tape, or \$22.95 Disk. (Both Animals and Body Parts \$29.95 Tape, or \$32.95 Disk.)



### Body Parts

(Bawdy Parts)

Have fun with artificial intelligence. This take-off on Animals is a riot. See if this program can guess the body-part you have in mind. The program learns, and responds with questions. If you give it x-rated clues, it turns into Bawdy Parts. 16K \$19.95 Tape, or \$22.95 Disk. (Body Parts and Animals \$29.95 Tape, or \$32.95 Disk.)

## UTILITIES

**DISK MANAGER**—Copy any program (or file) to another disk with only two key strokes. Kill disk programs with the same ease. All menu driven. A must for disk users. 16K \$24.95 Disk only.

**TAPE DUB**—Make personal copies of Basic and Machine Language tapes with ease. Completely automatic, menu driven. All machine language. 16K \$19.95 Tape, or \$22.95 Disk.

**REPEAT KEY**—Have your keyboard automatically repeat the key that was held down. It's great when you're typing programs! Position independent code. Machine language. Both 16K and 32K versions for \$14.95 Tape, or \$17.95 Disk.

**LLISTER**—Would you like to have program listings that "page break". How about program listings with nice margins? Works with any printer. Machine language. 16K \$14.95 Tape, or \$17.95 Disk.

\*\*\*\*\*

## OS9 Converter

The program you need with OS9 is here. Transfer your present disk files to OS9 formatted disks. Works with single or multiple drive systems. Completely menu driven. \$24.95 Disk

\*\*\*\*\*

**COLOR TUTOR**—An exceptional program for Language, History, Math and Vocabulary drills. You enter questions and answers. Program randomizes, presents questions, keeps lesson score. Store lessons for future use. Excellent for you or your children. 16K Ext. Basic \$19.95 Tape, or \$22.95 Disk.

- Shipping from stock NOW •
- Dealer inquiries invited •



- Add \$1 Postage and Handling •
- PA residents add 6% sales tax •

# THE TOP 4 COCO GAMES...



## CUBIX

By Spectral Associates. Very much like the arcade smash! Jump little Cubix around the 3D maze trying to change the color of all the squares. With Death Globes, Discs, Snakes, etc. 32K Tape: \$24.95

## ZAKSUND

From Elite Software comes this fantastic arcade style space action game with 3 different stages of moving 3-D graphics. You've never seen anything like this on your CoCo! Great sound too! 32K Tape: \$24.95

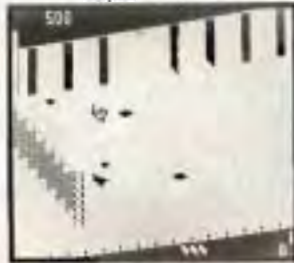

## THE KING

Previously called 'Donkey King', you simply cannot buy a more impressive game for your CoCo. With 4 different screens and loads of fun! From Tom Mix Software. 32K Tape: \$25.95

## GHOST GOBLER

From Spectral Assoc. This "PAC" theme game has been improved several times. It is definitely the best of its type. Brilliant color, action and sound, just like an arcade. 16K Tape: \$24.95



## COLORCADE SUPER JOYSTICK MODULE



WITH RAPID FIRE!

ONLY \$19.95

JOYSTICK INTERFACE/RAPID FIRE/6 FT. EXTENDER ALL IN ONE! The Colorcade allows connection of any Atari type joystick to your CoCo (including the Wico Red Ball). These switch type sticks are extremely rugged and have a faster and more positive response. They will improve the play of almost any action game.

An adjustable speed rapid fire circuit is built in. Press your fire button and get a great burst of fire instead of just a singleshot! You get a real advantage in shooting games that do not have repeat fire.

## ATARI JOYSTICK

ONLY \$8.50



THE BEST YOU CAN BUY WICO #15-9730

~~\$34.95~~  
\$29.95



WICO FAMOUS "RED BALL"

## ROM/PROJECT/PRODUCT CASE



Give a professional look to your project or product! High quality 3 piece injection molded plastic with spring loaded door. Designed especially for the CoCo ROM slot.

2-4 pcs. .... \$5.50 Ea.  
5-9 pcs. .... \$3.50 Ea.  
10-99 pcs. .... \$2.75 Ea.  
100 & UP. .... Call Us.

P.C. board for 27XX EPRCIMS. .... \$4.00 Ea.

## COLORWARE LIGHT PEN



ONLY \$19.95 WITH SIX FREE PROGRAMS ON CASSETTE!

The Colorware Light Pen plugs directly into your joystick port and comes with six fun & useful programs on cassette. Easy instructions show how to use it with Basic and it's compatible with light pen software such as Computer Island's "Fun Pack." Order yours today. Only \$19.95 complete.

## TELEWRITER-64

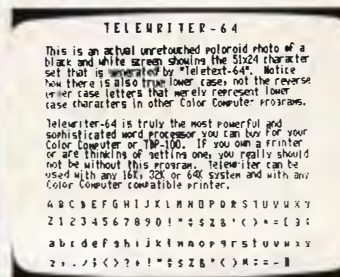

DISK ..... \$59.95  
CASSETTE... \$49.95

Colorware researched the word processors available for the Color Computer. This is the best. Telewriter-64 is a truly sophisticated system that is marvelously easy to use. It works with any 16K, 32K or 64K system and any CoCo compatible printer.

## TOP-RATED COCO WORD PROCESSOR

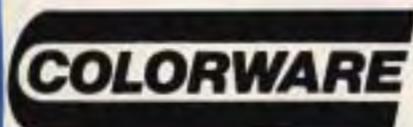

TOLL FREE ORDERING  
800-221-0916

ORDERS ONLY: N.Y. & INFO CALL (212) 647-2814

# 'REAL TALKER'

## HARDWARE Voice Synthesizer

**NEW from  
COLORWARE..  
only... \$59.95**

**THINKING OF BUYING A  
COCO VOICE SYNTHESIZER?**

**READ THIS....**

Making your computer talk couldn't be any easier! 'Real Talker' is a full featured, ready to use, HARDWARE voice synthesizer system in a cartridge pak. It uses the Votrax SC-01 phoneme synthesizer chip to produce a clear, crisp voice.

### FREE TEXT-TO-SPEECH

Included free with 'Real Talker' is Colorware's remarkable Text-to-Speech program. This is a truly powerful machine language utility. What it does is automatically convert plain English to speech. And it has an unlimited vocabulary! For example, use it in the direct mode: Type in a sentence or a paragraph, even mix in numbers, dollar signs, etc., then press enter. The text is spoken. At the same time a phoneme string is generated which can be saved to cassette or disk, modified or used in a Basic program.

We originally planned to sell this major piece of programming for about \$40.00 but decided it was so useful that no 'Real Talker' user should be without it. Besides, it really shows off the capability of 'Real Talker'.

Also included with 'Real Talker' is our unique Phoneme Editor program. It allows you to explore and create artificial speech at the phoneme level. Phonemes are the fundamental sounds or building blocks of word pronunciation. There are 64 different phonemes, as well as 4 inflection levels at your disposal. Creating and modifying speech at the phoneme level is both fascinating and educational. The Phoneme Editor may also be used to customize the pronunciation of speech produced by the Text-to-Speech program.



You don't have to use any of our utility programs though. If you write your own Basic Programs, you will find the pocket sized Votrax Dictionary (included free) is all you need to make your own Basic programs talk. This dictionary gives you quick access to the phoneme sequences used to create approximately 1400 of the most used words in the English language.

How about compatibility? 'Real Talker' is compatible with any 16K, 32K, 64K, Extended or non-extended Color Computer. It works with any cassette or disk based system, with or without the Radio Shack Multi-slot expander. No other synthesizer under \$100 can make this claim. Most other CoCo voice synthesizers require an expensive Multi-slot expander in order to work with the disk system. 'Real Talker' requires only an inexpensive Y-adaptor. This is an important consideration if you plan on adding a disk or have one already.

'Real Talker' comes completely assembled, tested and ready to use. It is powered by the CoCo and talks through your T.V. speaker so there is nothing else to add. Price includes Text-to-Speech and other programs on cassette (may be transferred to disk), User Manual and Votrax Dictionary. ONLY ..... \$59.95

'Y-BRANCHING CABLE' For disk systems. This 40-pin, 3 connector cable allows 'Real Talker' to be used with any disk system ..... \$29.95

### YOU DECIDE....

Order yours today on our Toll-Free Order Line. If you are not delighted with your 'Real Talker' system, simply return it within 30 days for a prompt, courteous refund.



COLORWARE INC.  
78-03F Jamaica Ave.  
Woodhaven, NY 11421  
(212) 647-2864



### \*\*\* ORDERING INFORMATION \*\*\*

ADD \$2.00 PER ORDER FOR SHIPPING & HANDLING.  
C.O.D.'S: ADD \$3.00 EXTRA.  
SHIPPING & HANDLING FOR CANADA IS \$4.00  
WE ACCEPT VISA, MASTER CARD, M.O.'S, CHECKS.  
N.Y. RESIDENTS MUST ADD SALES TAX.

```

*****
*
*   * 96K EXPANDER (96KX) *
*
*   The 96KX is a plug in cartridge that extends
*   the capability of Color Computers. An output Con-
*   nector is included for Disk Drives or Cartridges.
*   A Programmable Interrupt Switch is included that
*   allows the computer to be reset when the normal
*   reset fails or run any ML Program. Extended Basic
*   is not required & the cartridge works with all
*   Color Computers. The software is always available
*   as a HELP program and is called by a simple key-
*   board Command. Features include HEX to DECIMAL &
*   DECIMAL to HEX Conversions, Storing and retrieving
*   data in HEX, DECIMAL, ASCII, or VECTOR formats,
*   Displaying Statement Numbers & Memory, allows
*   changing Statement Numbers one at a time, quickly
*   moves blocks of data, displays the Beginning, End-
*   ing, & Execution Addresses of ML Programs, Condi-
*   tions for Stacking Programs, & much more. The 96KX
*   is Menu oriented & User Friendly. For 64K Compu-
*   ters the 96KX allows Basic to be run in either of
*   the two 32K Pages, or easily transfer information
*   from one page to the other or within either page.
*   One Year Warranty. 96KX CARTRIDGE $89.95
*
*   * VIDEO REVERSER *
*
*   The Video Reverser relieves eye strain from
*   operating Color Computers. Its 3 modes of opera-
*   tion are (1) Reversed Bright Characters against a
*   Dark Background, (2) All Capitals reversed for
*   spotting spelling errors in text, & (3) the Normal
*   power up display. The Video Reverser is a WIRED
*   assembly that mounts onto the MC6847 (VDG) Chip.
*   No soldering or experience is required. The dif-
*   ferent modes are selected by a 3 position toggle
*   switch that mounts in a 1/4" hole. $19.95
*
*   * DYNAMIC COLOR NEWS (Monthly Newsletter) *
*
*   An Engineering Newsletter that explains in
*   nontechnical terms how the Color Computer works.
*   We will inform you of the latest accessories and
*   developments in the Computer Field plus explain
*   what You can do to improve Your Computer. We will
*   also give operating hints to help you develop
*   competence in writing Basic & Machine Language
*   Programs. Included is a Q & A Section where we
*   give replies to your questions plus much more.
*   Receive discounts on our products. Cost $15 a year
*
*   Increase your Computer's Memory with the following
*   Memory Expansion Assemblies. Soldering is not re-
*   quired and the modifications are reversible. Each
*   assembly is warranted for a year. Items followed
*   by a "K" are unsoldered kits. Each Memory Chip in
*   these kits is tested but we can't warranty your
*   soldering. No soldering to the Computer. Instruc-
*   tions are included with each Kit & Assembly.
*   ME-1 8-16K CHIPS $14.95 ME-5 8-64K CHIPS $59.95
*   * 16K TO 32 K ME-3 $39.95 ME-3K $29.95 *
*   * F OR 285 TO 64K ME-4F $89.95 ME-4FK $71.95 *
*   * D & E TO 64K ME-4 $99.95 ME-4K $79.95 *
*   * Note: ME-4 & ME-4F require a 1.1 ROM. We will
*   * install our kits in your Computer for $10 + ship.
*   * SAM BUFFER - Amplifier that mounts on SAM Chip and
*   * protects it from shorts due to upgrading memory
*   * or other modifications. SAM BUFFER $8.95
*   * 128K MEMORY EXPANDERS are available. Also we
*   * have 128K Computers upgraded with our accessories.
*   * 6809E $24.95, 6883 $27.95, 6821 $5.95, 6847 $24.95
*   * 2764 $9.95, EPROM Cartridge with circuit bd $ 8.95
*   * Your Basic Program in a Cartridge up to 8K. $34.95
*
*   * DISK COMPATIBLE SOFTWARE ON TAPE. EB NOT REQUIRED *
*   * 6809 DECIMAL ASSEMBLER DISASSEMBLER -DISASM $19.95 *
*   * 300-2400 Baud Terminal Program (DYTERM). $14.95
*
*   * WE REPAIR COMPUTERS *
*
*   * checks, VISA & MC Cards. Add $2 ship.
*   * 24 HR phone. Call at nights & on weekends & save
*
*   * DYNAMIC ELECTRONICS INC
*   * Box 896 (205) 773-2758
*   * HARTSELLE, AL 35640
*
*****

```

```

1640 PRINT@288,V$;:FORT=1TO6:PRI
NT:NEXTT:PRINTV$;:RETURN
1650 'spare for special uses (7)
1660 RETURN
1670 'if 'blk' then prt blank
1680 IFA$="BLK" THEN A$=R$
1690 PRINT@129,A$
1700 READA$:GOTO1510
1710 'optional flag or fmlly name
1720 CLSO:FORT=68TO356STEP32
1730 PRINT@35,CHR$(229);CHR$(239
);
1740 PRINT@T,CHR$(234);S$;U$;T$;
1750 NEXTT
1760 PRINT@202,"H A T F I E L D"
;
1770 PRINT@111,"T H E";:PRINT@30
0,"F A M I L Y";:PRINT@334,"T R
E E";
1780 FORT=388TO484STEP32
1790 PRINT@T,CHR$(234);:NEXTT
1800 FORT=1TO3000:NEXTT:RETURN

```

## Important Announcement

```

10 CLS RND(8)
20 DATA 68,79,78,39,84,32,77,73,
83,83
30 FOR X = 1 TO 10
40 READ A
50 PRINT @ 234+X, CHR$(A);
60 SOUND RND(255),1
70 NEXT
80 DATA 82,65,73,78,66,79,87,70,
69,83,84
90 FOR X =1 TO 11
100 READ A
110 PRINT @ 233+X, CHR$(A);
120 SOUND X*10,1
130 NEXT
140 DATA 67,65,76,73,70,79,82,78
,73,65,32,83,84,89,76,69,33,32
150 FOR X = 12 TO 29
160 READ A
170 PRINT @ 251+X, CHR$(A);
180 SOUND RND(255),1
190 NEXT
200 DATA 76,79,78,71,32,66,69,65
,67,72
210 FOR X = 30 TO 39
220 READ A
230 PRINT @ 333+X, CHR$(A);
240 SOUND RND(255),1
250 NEXT
260 DATA 70,69,66,82,85,65,82,89
,32,49,55,45,49,57,33
270 FOR X = 40TO54
280 READ A
290 PRINT @ 128+X, CHR$(A);
300 SOUND RND(255),1
310 NEXT
320 FOR XX=1 TO 3000:NEXT
330 RUN

```

# One stop shopping for the Color Computer

Try our  
Computer  
Ordering  
Line!

Call:  
1-419-537-8937

and enter  
the future  
TODAY!

## GEMINI-10X DOT MATRIX PRINTER

FROM **\$369**



**MORE QUALITY:** 120 cps • thruput time of 55 lpm • resolution (120x144) bit image & block (6x6) graphics • extra fast forms feed

**MORE FLEXIBILITY:** super/sub script • underlining • backspacing • double strike mode • emphasized print mode • compatible with most software supporting leading printers • 10\* carriage • 15 carriage Gemini 15 available.

**MORE RELIABILITY:** 180-day warranty (90 days for head & ribbon) • mtbf rate of more than 5 million lines • print head life of more than 100 million characters.

DELTA 10.....	\$649.00
GEMINI 15X.....	\$549.00
DELTA 15.....	\$799.00

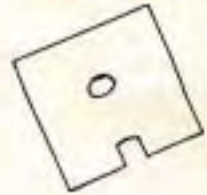

**FLIP-IT!**  
Punch your  
disks  
for double  
the storage  
**\$9.95**

## Your Printer Shopping Place

### TRANSTAR

315 7 Color Printer with CoCo screen dump software.....	\$599.00
120 10 inch Daisywheel Printer 14 CPS/standard wheel.....	\$599.00
130 15 inch Daisywheel Printer 16 CPS/standard.....	\$895.00

### OKIDATA

82A 120CPS/132 column 9 1/2".....	\$ 549.00
83A 120 CPS/244 column 15".....	\$899.00
84A 200 CPS/231 column 15".....	\$1395.00
92 160 CPS/136 column 9 1/2".....	\$ 699.00

#### OTHER PRINTER LINES AVAILABLE:

NEC  
ANADEX  
JUKI  
MANNESMAN TALLY  
SILVER REED

### BOTEK

Serial to Parallel Converter  
transfer data to your printer  
at up to 9600 BAUD  
**\$69.95**

### LEADING EDGE

Gorilla 12" Greenscreen.....	\$ 99.95
Banana Printer 60 CPS with graphics.....	\$249.95
Video Plus (computerware) Monitor Adapter ..	\$ 24.95

Please include phone number with all orders. Also add \$5.00 s/H for all printer and computer orders.  
\$2.00 for all software orders. Ohio residents please add 6% state sales tax.

**1-800-242-COCO (outside Ohio)**

## DISCOVER THE WORLD OF COMPUTING WITH

**REITZ**  
COMPUTER CENTER™

3170 W. Central Avenue  
Westgate Meadows Shopping Center  
Toledo, Ohio 43606  
Phone (419) 537-1432 (in Ohio)  
Fort Wayne Area call (219) 493-7251  
10 a.m. to 9 p.m. EST



# WHICH "WEIGH" TO GO?



**OS-9**

Taken from Microware's brochure, "OS-9 is a Unix-like multitasking, real-time operating system. Its modular structure makes OS-9 easily adaptable. OS-9 is widely used for applications in data processing, industrial automation, communication, instrumentation and education."

## OS-9 FEATURES:

- \* Real-time multitasking executive.
- \* Hierarchical disk-file directories.
- \* Device independent, interrupt-driven I/O
- \* Modular software memory management
- \* Command interpreter with I/O redirection

Developed by Microware and Motorola about 3 years ago, OS9 has enjoyed a loyal following among users. There are several very good languages available for it. These include Basic09, Pascal, "C" and Cobol. Also, there are 2 exceptional Word Processors; DynaStar and Stylograph. To check spelling, Dynaspell and Stylograph's spelling checker are available. OS-9 is an excellent choice for control applications, and because of the demand for UNIX like operating systems it is an excellent choice for the CoCo. On the CoCo it offers type-ahead and a limited multi-user capability. Disk support is single-sided, double-density up to 40 tracks. Printer baud rates up to 4800 are supported. The operating system also provides graphics capability although the text screen, like that under RS DOS, is only 32 by 16. Memory is 42K of user RAM (33K with the use of a HiRes screen).

FHL has more software for OS-9 than everyone else combined! The perfect first choice is 'O-Pak', which adds a Hi-Resolution Screen and Copy utilities. Many other software packages require O-Pak to function. Some of the other OS9 software packages available from FHL are: SUPER SLEUTH Disassembler, CRASMB Cross Assembler, DYNAMITE+ Disassembler, A/BASIC Basic Compiler, and DO - A Job Control Language. Check our other ad for specifics or better yet, get our catalog. It's FREE!

**FLEX**

FHL FLEX is the most popular "true" operating system for the CoCo. It has been available for 2 years and has more software available for it than any other Color Computer operating system. FLEX is easy to use and is known as being 'User Friendly.' The abundance of excellent software available makes it a good choice for the CoCo. FLEX has 46K of user RAM WITH a HiRes screen. This makes it possible to run complex business software like A/R, and spreadsheets like DynaCalc. FLEX supports 35, 40, or 80 track single or double-sided 5 1/4" drives. It even supports 3" drives! With FLEX you get:

- \* One disk startup w/ 1.0 or 1.1 ROM
- \* Easy startup, just type RUN "FLEX or DOS
- \* HiRes screen built in
- \* Online HELP capability
- \* Supports all 3" or 5 1/4 " drives:
- \* Option: DBASIC (RS Disk Basic under FLEX)
- \* Great programming ease
- \* A User Friendly environment
- \* A system suited to the casual user
- \* The most support software for any CC DOS
- \* Hundreds of articles to help the new user

All this for only **\$89.95**  
Optional DBASIC **\$30.00** extra.

## FINAL NOTE

Making the choice between two very good operating systems is undoubtedly difficult. No other small computer has such a rich choice. The Color Computer user is extremely lucky to be able to choose from such offerings. So, the choice is hard. You could buy both and then decide, but that is costly. Many of the CoCo publications have been writing articles and columns about FLEX for 2 years, and similarly many will be writing about OS-9 too. It may take a while before a comparison can be made from them. The best way to decide for now is to determine what your software needs are and buy the operating system that supports them. We at FHL support BOTH operating systems. Call us for help concerning software availability or any other assistance you may require. Send for our FREE 32 page catalog and see our other ads.

\*OS-9 is a registered trademark of Microware Inc. and also FLEX is a registered trademark of Technical Systems Consultants, Inc.

## FHL Color FLEX

FLEX is the disk operating system you need to run all this software and more on your 64K Color Computer! A single-user system designed to be very powerful yet very easy to learn to use. FLEX features dynamic filespace allocation, random and sequential file accessing, batch job type program entry, user startup facility, automatic drive searching, file dating, space compression, complete user environment control, English error messages, smooth scrolling and much more!

### INCLUDES:

- EASY STARTUP
- ONLINE "HELP" CAPABILITY
- NEW "TED" TINY EDITOR
- NEW "ISM" INTERACTIVE ASSEMBLER
- EXTERNAL TERMINAL PROGRAM
- SIX DIFFERENT HI-RES SCREENS
- NEW SMOOTH SCROLLING
- NEW VARIABLE RATE SCROLLING
- RECONFIGURABLE TO YOUR NEEDS
- SUPPORTS ALL 3" AND 5" DRIVES

All this for only **\$69.95!**

## LANGUAGES

### DBASIC

Radio Shack 1.0 Disk Basic adapted to work with FHL Color FLEX: **\$30.00**

### TSC Extended BASIC

TSC XBASIC for CoCo FLEX: **\$100.00**

### TSC PASCAL

TSC PASCAL CoCo FLEX **\$200.00**

### A/BASIC COMPILER for OS9 and FLEX

Produce fast, compact, ROMable object code from easy to write BASIC source code.

CoCo FLEX or OS9 Object only: **\$75.00**

### DYNASOFT PASCAL for FLEX and OS9

This remarkable Pascal Subset is a p-code implementation that only requires 12K of RAM!

CoCo FLEX or OS9: **\$59.95**

### NEW! DYNA-C for FLEX and OS9

This new "C" subset runs circles around any others in its price class!

CoCo FLEX or OS9: **\$59.95**

### INTROL-C COMPILER for FLEX and OS9

A complete, efficient, fast C compiler which includes a Macro Relocating Assembler/Linking Loader, Runtime Library, and Library Manager.

CoCo FLEX or OS9: **\$375.00**

## SOFTWARE DEVELOPMENT TOOLS

### ED/ASM

Full feature line-oriented Editor and conditional macro Assembler.

CoCo FLEX version: **\$69.95**

### OSM

An Extended 6809 Macro Assembler  
Generate OS9 or FLEX binary! **\$99.00**

### CRASMB Macro Cross Assembler

Use the Macro Cross-Assembler and any of the following CPU Personality Modules (CPM's) to assemble that CPU's Source code into OS9, FLEX, Motorola S1-S9 or INTEL-HEX formatted Object code files. Available CPM's: Motorola 6800-2-8, 6801-3, 6805, 6809, Mostek 6502, RCA 1802, INTEL 8080-5, ZILOG Z-80.

CoCo FLEX or OS9:  
CRASMB Object only: **\$200.00**  
CPM's Object only: **\$ 35.00 each**  
CPM's with Source: **\$ 70.00 each**

\* SPECIAL \* Purchase CRASMB with all modules (Source included) for **\$499.00**

### SUPER SLEUTH

Examine and modify or disassemble binary program files into source code format. Object code for 6800, 01, 02, 03, 05, 08, 09, or 6502 may be processed.

Object only:  
CoCo OS9: **\$49.95**  
CoCo FLEX: **\$50.00**  
RS DOS: **\$49.00**

### DYNAMITE+

Easy to use disassembler complete with cross-reference generator, and label files maintained in text form only.

Object only:  
CoCo FLEX: **\$100.00**  
CoCo OS9: **\$150.00**

### TSC DEBUG

Set up to 32 breakpoints. A must for anyone serious about Assembly Language programming!

CoCo FLEX version: **\$75.00**

### FHL FLEX Color Utilities

This combination of Toolkit #2 and Extended utilities for FLEX includes: REPAIR, SCAN, REPLACE, INIT, USERINFO, LOAD, SAVETEXT, READTEXT, DISK DUMP, LNKMAT, SEGMAP, MAP, AND DINFO.

Object only: **\$50.00**  
w/Source: **\$75.00**

### TSC FLEX UTILITIES

This set of FLEX utilities includes memory dump, prompting delete, extended directory display, binary program mapper and 13 more!

**\$75.00**

## TSC FLEX DIAGNOSTICS

Examine and repair your FLEX disks. Recover data from a disk with a damaged directory.

CoCo FLEX version: **\$75.00**

## APPLICATIONS SOFTWARE

### DYNASTAR SCREEN EDITOR Word Processor

This extremely powerful, menu-driven Word Processing system is composed of Dynastar, the Text Generator and Dynaform, the Text Formatter/Mail Merge program.

DYNASTAR: for FLEX or OS9: **\$ 49.95**  
DYNASTAR: for FLEX or OS9: **\$ 49.95**  
Purchased together: **\$ 90.90**

### DYNASPELL Spelling Checker

Use with Dynastar or Stylograph for a complete word processing system. Now with new LOOKUP command!

CoCo FLEX or OS9 versions: **\$59.95**

### STYLOGRAPH

A complete word processing system which offers total formatting control.

CoCo FLEX: **\$149.95**  
CoCo OS9: **\$149.95**

### DYNACALC

The powerful electronic spreadsheet for 6809 computers!

CoCo FLEX: **\$200.00**

### RMS RECORD MANAGEMENT SYSTEM

Five machine language programs that make up one of the most powerful business programming tools available.

CoCo FLEX and OS9 versions: **\$200.00**

### UDRI SOFTWARE FOR FHL FLEX

- DATA-BASE MANAGER  
Part I: **\$49.95** Part II: **\$ 49.95**
- BALANCED BILLING SYSTEM: **\$ 49.95**
- PAYROLL PACKAGE: **\$ 99.95**
- SINGLE-ENTRY LEDGER: **\$ 49.95**
- CHURCH CONTRIBUTIONS: **\$ 49.95**
- ACCOUNTS RECEIVABLE: **\$ 99.95**
- ACCOUNTS PAYABLE: **\$ 99.95**
- GENERAL LEDGER: **\$189.00**
- INVENTORY 2: **\$ 69.00**

**FHL FRANK HOGG LABORATORY**  
THE AGENCY FOR HIGH-BYTE SOFTWARE - 110 JARVIS ST. - SYRACUSE, NY 13203  
PHONE (315) 747-7850 • TELEX 640740

# A Valentine Printer Mystery

*This is the fourth installment in a continuing series of short 'Printer Mysteries' which began in November.*

**H**ere's the latest printer mystery for those who have the *Printer Artist* program from the November issue of *the Rainbow*. Of course, we won't tell you what it is, other than to say that it's an appropriate February epistle for your girlfriend, boyfriend, wife or husband.

Since the first *Printer Art* first appeared in *Rainbow*, we've heard from a couple of people with problems. In one case, a reader had trouble with the Halloween witch. We couldn't duplicate the problem ourselves, but after an exchange of correspondence we found out that his CoCo was actually adding wrong. Has anybody else had this experience?

Also, some folks with non Radio-Shack printers (like my Gemini 10), and some with the new DMP-120, occasionally find that the printer drops the first character in a line. One reader said Radio Shack told him the trouble was with the computer's output. Anyway, you can solve this problem by adding a half-second line delay. Just *POKE 151,128:POKE 152,0* before *RUNning* the program.

To create the drawing below, run the *Printer Artist* program and type in the characters as you see them listed here, one line at a time. For example, if a line reads "23sp 16M 14:" you should strike the space bar 23 times, strike the "M" key 16 times and strike the colon key 14 times.

For those interested in more sophisticated art, a complete four-program *Printer Artist* development system is available from Federal Hill Software, 825 William St., Baltimore, MD 21230.

**By**  
**Michael J. Himowitz**  
**and Julius Nelson**

LINE

- |   |                                |                     |
|---|--------------------------------|---------------------|
| 1 19sp 2M                                       | 15 26l 35M 3l                  | 29 10sp 10l 8sp 26l |
| 2 12s 6l 4M 24sp 4l 1M 1l 1M                    | 16 27l 2M 1l 32M 2l            | 30 11sp 11l 4sp 27l |
| 3 9sp 10l 5M 17sp 8l 2M 1l 2M 1l 1M             | 17 1sp 28l 14M 2l 14M 4l       | 31 12sp 40l         |
| 4 6sp 15l 3M 2l 2M 1l 1sp 10l 2M 1l 1M 1l 3M 2l | 18 1sp 25l 15M 3l 13M 6l       | 32 14sp 36l         |
| 5 4sp 18l 3M 2l 1M 2sp 1M 5sp 12l 8M 1l 3M      | 19 2sp 23l 2M 1l 11M 5l 6M 12l | 33 15sp 34l         |
| 6 3sp 19l 11M 14l 11M 3l                        | 20 2sp 16l 4sp 3l 13M 24l      | 34 16sp 32l         |
| 7 2sp 21l 10M 13l 13M 3l                        | 21 3sp 11l 10sp 3M 34l         | 35 17sp 30l         |
| 8 1sp 22l 13M 8l 11M 8l                         | 22 3sp 9l 12sp 1V 1sp 35l      | 36 19sp 26l         |
| 9 24l 13M 5l 10M 12l                            | 23 4sp 6l 17sp 33l             | 37 21sp 22l         |
| 10 24l 13M 2l 11M 14l                           | 24 5sp 5l 20sp 29l             | 38 23sp 18l         |
| 11 25l 23M 16l                                  | 25 6sp 6l 20sp 26l             | 39 25sp 14l         |
| 12 25l 21M 18l                                  | 26 7sp 7l 20sp 23l             | 40 27sp 10l         |
| 13 26l 31M 7l                                   | 27 8sp 8l 16sp 24l             | 41 29sp 6l          |
| 14 26l 28M 2l 3M 2l 3M                          | 28 9sp 9l 12sp 25l             | 42l 31sp 2l         |

*(Mike Himowitz is a Washington correspondent for the Baltimore Evening Sun and proprietor of Federal Hill Software. Julius Nelson is one of the world's foremost authorities on typing education and inventor of the craft known as "Artyping.")*



# \* TALKING PROGRAMS



The Final Countdown



SCORE-EZ

**NEW**

## TALKING FINAL COUNTDOWN

(by Bill Cook)

Now speech has been added to the excitement of this superb adventure. You must stop the mad general from launching a missile at Moscow and causing WW11. Has multiple voices for added realism. For 32K EXT.....\$24.95  
Standard cassette  
FINAL COUNTDOWN.....\$14.95

**NEW**

## SPELL-A-TRON

This educational program will assist in teaching children how to spell. The program allows the user to build a dictionary of words, with proper pronunciation as well as spelling, and then the test mode can be entered for use by the child. The program will both spell the word and say the word if the child is not correct. Uses only positive reinforcement, and is very user friendly. For ANY age child or adult. With documentation. 32K EXT...\$28.95

**NEW**

## TALKING SCORE E-Z

An excellent adaptation of yahtzee type program with the addition of speech. Up to six players can compete at a time, and all scoring and record keeping is done by the computer. Requires the Spectrum Speaker, and 32K ext. basic. Let your computer talk to you for a change. On cassette for only.....\$24.95  
Standard SCORE E-Z.....\$15.95

\* All JARB Software talking programs require the Spectrum Speaker to work.  
Look for more talking programs to come.

## UTILITIES

From



### SPECTRUM PROJECTS

64K UTILITY PACK (disk) includes 40K, Romcrack, and Spool 64 only. ....\$21.95

40K on cassette (diskable) when used with a 64K computer will give you a 40K of user ram to be used as you wish.  
Only.....\$9.95

TAPE UTILITY (disk) includes tape to disk, disk to tape, and more.  
Now only.....\$24.95

SCHEMATIC DRAFTING PROCESSOR (disk) can draw large scale schematics in hi-res (has six overlapping screens) and then print them out to any of several popular printers, fast!! A must for serious hardware computerist.  
Now only.....\$49.95

★ ★ ★ ★ ★ ★ ★

**JARB** SOFTWARE  
COMPUTER PRODUCTS

1636 D Avenue, Suite C  
National City, CA 92050  
BBS (619) 474-8981  
VOICE (619) 474-8982

### ARCADE ACTION!!!

### JUNGLE TREK

Lost in a jungle with wild animals lurking; your only survival is to find a safe compound before you are lunch for lions; high resolution; multi-color.  
16K EXT.....\$14.95



**NEW**

### SPECTRUM SPEAKER

This excellent hardware/software combination gives the best speech available to the color computer user. The hardware plugs into the ROM pack port, and uses the Votrax SC01 phoneme synthesizer for superior speech. The software consists of both BASIC and M/L programs to allow for text to speech conversion, pre- or user defined dictionary of words, and easy interfacing to any basic program. Best of all, if you use the multipac interface by R/S you can use both the disk drives and the Spectrum Speaker at the same time. This opens up new worlds of use for the combination. Both 16K and 32K software are included, and the price is only . \$69.95

*We carry products  
from many manufacturers.  
If you don't see it, ask.*

U.S FUNDS ONLY  
C.O.D. ORDERS ACCEPTED  
NO CREDIT CARD ORDERS

SHIPPING AND HANDLING: Unless otherwise specified, all orders \$3.00 per order. California Residents add 6% sales tax.





THE  
AMAZING ADVENTURES  
OF

# KARRAK

## Conquest of the Castle Caverns

By Gregory Clark

**K**arrak is a warrior in the kingdom of Blenfor. His strength and courage have reached almost legendary proportion, in spite of his relatively young age of 26 cycles.

He has heard of strange things going on in the area of an old castle located in the Eastern Mountains. So old is this castle that the original owner's name has been forgotten. All that is known for sure is that no one has lived there since his death.

Recently people, livestock and materials have been reported missing in that area. The reports have been coming at an ever-increasing rate. Along with the reports are rumors to the effect that an evil entity has taken up residence in the old castle and has been sending forth terrible creatures into the countryside to pillage.

Karrak arrives at the entrance of the old castle. Vines and brambles have all but overgrown the walls. There is no sign of recent passing in the dirt leading to the entrance. Karrak takes note that, as he steps forward and enters, the sun disappears behind an especially dark cloud.

# BLACKJACKPRO



## BLACKJACKPRO

A computer assisted learning tool  
that will pay for itself.  
Expert play will become  
easy and natural.

Read about BLACKJACKPRO on page 145

BLACKJACKPRO is a trademark of Skillware Corporation

# SKILLWARE

## INSTRUCTIONS

*Karrak* is a four-part Adventure game written for the 16K Color Computer in non-Extended BASIC.

There are six listings for the game. To assemble them into four Adventures, follow these steps:

Type in listing 1 (*KAR-1*).

\*If you have Extended BASIC, now substitute listing 6 (*KAR-6*) for lines 200-240 in listing 1. This is a faster search routine and will speed up the playing considerably.

Make four copies of listing 1 on four different tapes. These will comprise the base of the four Adventures. Make sure of your typing at this point, as a mistake here will appear in all four Adventures and will cause you to have to bug out four programs instead of one.

With listing 1 in memory, type in listing 2 (*KAR-2*). Save the result on tape and label as Game 1.

Turn off your CoCo and then load your next copy of listing 1 into memory. Now enter listing 3 (*KAR-3*). Save the result on tape and label as Game 2.

Turn off your CoCo and then load your next copy of listing 1 into memory. Now enter listing 4 (*KAR-4*). Save the result on tape and label as Game 3.

Turn off your CoCo and then load your last copy of listing 1 into memory. Now enter listing 5 (*KAR-5*). Save the result on tape and label as Game 4.

You now have four separate 16K Adventures, but — before you load in Game 4 and attempt to solve it in record time — read on. *Karrak*'s four Adventures must be played in order. Each time a section is completed, the program will instruct you in making a data tape. This tape must be entered when you start Games 2-4. This allows for two things while it is not a "game in progress" save, it allows you to finish one section and not have to keep playing. You can come back at anytime and pick up where you left off, at least by game. It prevents someone from starting on Game 4 and cheating him/herself out of the first three games.

*Karrak* is written for the beginning Adventurer; the first two games are meant to be an instructional experience. Parts three and four get down to some real Adventuring. As a word of caution, don't hurry through each section; Adventuring is not a race. In fact, you can get from one section to another without getting everything you may need in a later game.

*Karrak* is an interactive Adventure. What I mean is, if you just move about from room to room and don't do anything, all you will get is death. You have to imagine you are *Karrak*. Look at things, take them if you feel they may help you later, try different actions. This program has a built-in vocabulary of actions and objects. It would be unrealistic for me to believe that you will not notice them as you type in the listings. Don't be ashamed to write them on a piece of paper for future reference, you should have fun with this program — not heartburn. The whole premise of an Adventure is to put the actions and objects together at the right time, in the right order and solve the puzzle.

When you load in Game 1 you will see a title page and then a screen of information. You will be asked what you wish to do. Remember, you are *Karrak*, not the person who just typed in the listings. All you have to work with now is what you have on the screen. You may now attempt to do anything you wish, within the confines of the program's vocabulary. You may, for example, drop your sword by typing in "drop sword" and pressing [ENTER]. You will then be shown what the result of this action is. In this case, you will be advised that there is a sword now on the ground. (Hint — don't leave it there.) You may use any combination of actions and objects you desire. Not all will work as most will not make any sense until the correct time. Along with allowing you to input actions and objects, there are a few one-key entries allowed. These do away with repetitive typing. For example, you just input "E" to move East, rather than typing "Move East." A listing of these follows:

The first letter of the direction to move is all that need be entered.

& Restores the screen if the [CLEAR] or [BREAK] key are accidentally pressed.

[ Gives the room description, if any.

↑ Gives a list of items in your hands.

— Gives a list of items in the sack.

] Gives *Karrak*'s strength (more about this later).

! Is used in combat. It is equal to "hit the opponent with major weapon."

= Is used in combat. It is equal to "hit the opponent with minor weapon"

Now, some answers to those questions. If *Karrak*'s strength reaches zero, he is dead and the game ends — you have to start over and try again. A major weapon is a sword or mace, a minor weapon is a dagger or a hand axe. In combat, if you have two major wea-

pons in hand, the sword is the weapon used. In other words, have only one of each type when fighting, or you will not gain anything. If you find you are confronted by an enemy, just enter "!" or "=" and the results of the action will be displayed. Choice of weapons may be crucial. As an example, in real life, if you faced a fire, a handful of tissues may be fine for a runny nose, but I'd rather use the extinguisher. You have to choose based on the opponent. This may mean a few deaths, but all you have to do is rerun the program to get another chance.

One more word of advice — this is an Adventure, based on a make-believe character in an imaginary setting — don't be surprised if a few touches of magic are thrown at you.

Karrak is ready to step into the castle; imagine yourself as a mighty warrior and step in with him.

(Greg Clark works for New York Telephone Co. and in his spare time enjoys writing Adventure programs. His wife, Ruth, is quietly supportive of the time spent at his hobby.)

### Program Summary

100	Dimensions	500	GET Routine	12990	Actions Not Found Trap
105	Read Data	600	LIST Routine	15000	Reassign Dropped & Left Behind Objects Value of P
110	Variable Setups	700	DROP Routine	1510	Set allowable Moves On Basis Of Value of O & T
140	Introduction	950	Change Location On Moves	20000	Data Lines
150	Main Input Line	975	Assign Next Line On Basis Of Value Of "P"	25000	Set Up For Variable Values To Tape
155	Variable Cancels	1000	Moves For Value P 101-125	26000	Set Up For Variable Values From Tape
200-	Search For Action	2000	Actions For Value P 201-225		
215	tion	3000	Moves For Value P 201-225		
220-	Search For Object	4000	Actions For Value P 201-225		
230	ject	5000	Moves for Value P 301-325		
247-	Search For Particular Actions & Objects	6000	Actions for Value P 301-325		
300	Look In Knapsack Routine				
400	Put In Knapsack Routine				

Rainbow Check	
	Plus
147 .....	0215 101
215 .....	04F7 107
260 .....	0720 153
900 .....	0A5D 220
12995 .....	0D12 199
15205 .....	0FC4 19
END .....	124C 61

Listing 1

```

1 REM karrak-WRITTEN BY GREGORY
CLARK, 122 MALE AVE, SYRACUSE, NY
13219/315-487-8406/16K BASIC
102 X=RND(-TIMER)
105 FORX=1TO20:READB$(X):NEXT:FORX=1TO20:READC$(X):NEXT:FORX=1TO20:READD$(X):NEXT:FORX=1TO25:READA2$(X):NEXT:FORX=1TO25:READA1$(X):NEXT:FORX=1TO25:READA3$(X):NEXT:FORX=1TO12:READKA(X),AK(X):NEXT
106 N$="KARRAK IS DEAD"
107 IFAK(12)<>49THEN26000
140 FORX=1030TO1510STEP32:FORY=0TO5:BK=Y+1:POKEX+Y,AK(BK):NEXTY,X:FORX=1043TO1260STEP31:FORY=0TO5:BK=Y+1:POKEX+Y,AK(BK):NEXTY,X:FORX=1292TO1523STEP33:FORY=0TO5:BK=Y+1:POKEX+Y,AK(BK):NEXTY,X:FORX=1TO4000:NEXT
143 CLS:FORX=1TO12:POKEKA(X),AK(X)

```

```

X):NEXT
145 PRINT@0,"location":PRINT@32,"moves":PRINT@64,"i see"
147 MV=1:GOTO975
150 SOUND100,1:PRINT@224,"":PRINT@192,"WHAT DO YOU WANT TO DO":INPUTA$
152 PRINT@256,"":PRINT@288,"":PRINT@320,"":PRINT@352,"":PRINT@384,"":PRINT@416,"":PRINT@448,""
155 B=0:C=0:J=0:MV=0:H$="":F$=""
159 IFA$="]"THENPRINT@160,"KARRAK'S STRENGTH="INT(AG):GOTO150
160 IFA$="&"THENMV=1:GOTO143
161 IFA$="["THENB=7:GOTO900
162 IFA$="^"THENB=5:GOTO600
163 IFA$="_"THENB=1:C=9:GOTO300
164 IFAK(12)=52ANDP=115ANDA$="N"THENN=1
165 IFA$="!"ORA$="="THENIFAE=0ANDAF=0THENPRINT@288,"NOTHING TO FIGHT HERE":GOTO150
166 IFA$="!"ANDC(1)=1THENB=2:H$=C$(1):GOTO245
167 IFA$="="ANDC(4)=1THENB=11:H$=C$(4):GOTO245
168 IFA$="!"ANDC(12)=1THENB=2:H$=C$(12):GOTO245
169 IFA$="="ANDC(13)=1THENB=11:H$=C$(13):GOTO245
170 IFLEN(A$)<1THEN150ELSEIFLEN(

```

```

A$) <2THEN IF AE=0 AND AF=0 THEN MV=1:G
OTO950 ELSE 245
200 FORB=1 TO 20:FORX=1 TO LEN(A$):D
$=B$(B):L=LEN(D$):IF MID$(A$,X,L)
=D$ THEN MID$(A$,X,L)="":GOTO 22
0
210 NEXT X,B:B=0
215 PRINT@256,"I CAN'T DO THAT":
GOTO 150
220 FORC=1 TO 20:FOR Y=1 TO LEN(A$):D
$=C$(C):L=LEN(D$):IF MID$(A$,Y,L)
=D$ THEN 245
230 NEXT Y,C:C=0
235 FORJ=1 TO 20:FOR Y=1 TO LEN(A$):D
$=D$(J):L=LEN(D$):IF MID$(A$,Y,L)
=D$ THEN 245
240 NEXT Y,J:J=0
245 IF AE=1 THEN 30110 ELSE IF AF=1 THE
N 30510 ELSE IF B=1 AND C=9 THEN 300
246 IF B=3 THEN PRINT@256,"WHERE":I
NPUT F$:IFF$=C$(9) THEN 400 ELSE 975
247 IF B=4 THEN 500
248 IF B=5 THEN 600
249 IF B=6 THEN 700
250 IF B=7 THEN 900
251 IF B=11 THEN PRINT@256,"WITH WH
AT":INPUT H$:GOTO 975
252 IF B=2 THEN PRINT@256,"WITH WHA
T":INPUT H$:GOTO 975

```

```

253 IF B=8 AND C=6 AND C(6)=1 AND C(7)=
0 THEN C(7)=3:PRINT@288,"A COIN FE
LL OUT":GOTO 15000
254 IF B=12 AND C=10 THEN PRINT@288,"
WITH WHAT":INPUT LI$:IF LI$=C$(2) T
HEN IF C(10)=1 OR C(10)=3 THEN IF C(2)=
1 THEN PRINT@448,"IT IS LIT":AK=1:
AL=0:MV=1:GOTO 975
260 GOTO 975
300 F=0:IF C(9)=1 THEN 310 ELSE PRINT
@288,"I DON'T HAVE THE SACK":GOT
O 150
310 PRINT@288,"I SEE IN THE SACK
":FORX=1 TO 20:IF C(X)=2 THEN PRINT@
320+(F*8),C$(X):F=F+1
320 NEXT X:IFF=0 THEN PRINT@320,"NO
THING":GOTO 150 ELSE GOTO 150
400 IFF$=C$(9) THEN 410 ELSE 975
410 IF G>7 THEN PRINT@352,"THE SACK
IS FULL":GOTO 150
420 IF C(C)=1 THEN C(C)=2:G=G+1:H=H
-1:PRINT@288,"I PUT IT IN THE SA
CK":GOTO 150
430 PRINT@288,"I DON'T HAVE THE
"C$(C):GOTO 150
500 IF H>1 THEN PRINT@288,"MY HANDS
ARE FULL":GOTO 150
510 IF C(C)=2 THEN C(C)=1:H=H+1:G=G
-1:PRINT@288,"I HAVE THE "C$(C):
GOTO 150
520 IF C(C)=3 THEN C(C)=1:H=H+1:PRI
NT@288,"I HAVE THE "C$(C):IF C=9 T
HEN H=H-1:GOTO 15000 ELSE GOTO 15000
530 IF C(C)=1 THEN PRINT@288,"I ALR
EADY HAVE IT":GOTO 150
540 PRINT@288,"I CAN'T GET IT":G
OTO 150
600 F=0:PRINT@256,"I HAVE:":FORX
=1 TO 20:IF C(X)=1 THEN PRINT@288+(F*
8),C$(X):F=F+1
610 NEXT X:IFF=0 THEN PRINT@288,"NO
THING":GOTO 150:ELSE GOTO 150
700 IF C(C)<>1 THEN PRINT@288,"I DO
N'T HAVE IT":GOTO 150
710 IF C=9 THEN H=H+1
720 H=H-1:C(C)=3:PRINT@288,"I DR
OPPED THE "C$(C):GOTO 15000
900 MV=1:GOTO 975
950 FORX=1 TO 20:IF C(X)=3 THEN C(X)=
P
951 NEXT X
952 FORX=1 TO 20:IF D(X)=3 THEN D(X)=
P
953 NEXT X
954 IF A$="N" AND N=1 THEN VV=VV-1:GO
TO 975
955 IF A$="S" AND S=1 THEN VV=VV+1:GO
TO 975
960 IF A$="W" AND W=1 THEN HV=HV-5:GO
TO 975

```

**Saguaro Software**

7331 E. Beverly Dr.  
Tucson, AZ 85710  
**(602) 885-6508**

Business/Utilities		
Prickly-Pear Mailing List (Disk) New Ver	P.P.	37.75
Real Estate Investment	PFA	18.75
Statistical Analysis	PFA	26.75
Statgraf	Sugar	20.75
Stress Evaluator	PFA	18.75
Timis Mail	Sugar	15.75
Timis Database	Sugar	20.75
Bond Yield	PFA	17.75
Co-Co Receivables (New)	Saguaro	29.95
Eight-Bit Bartender (Office Parties!)	P.P.	14.75
Colorkit	P.P.	26.75
Disk Manager	P.P.	18.75
Disk Master (Disk) New Ver	P.P.	18.75
Disk Zapper!!!	P.P.	26.75
Omni Clone (Lowest Price!)	P.P.	29.75
Super Disk Utility (Disk)	PFA	35.75
Auto Run	Sugar	15.75
Semigraf	Sugar	15.75
Move-It!	Saguaro	15.95
Automatic Tape To Disk		

DISK available - add \$3.00/program. Amdek disk add \$6.00/program. Add \$1.00 per item shipping (\$4.00 maximum). Az. residents add 7% tax.

We carry Prickly-Pear, Petrocci Freelance Associates, and Sugar Software. Authors...check with us about royalties.

```

962 IFA$="E"ANDV=1THENHV=HV+5:GO
T0975
965 IFA$="U"ANDU=1THENLV=LV-100:
GOTO975
968 IFA$="D"ANDD=1THENLV=LV+100:
GOTO975
970 PRINT@288,"I CAN'T MOVE THAT
WAY":FORX=1TO300:NEXT:GOTO150
975 P=VV+HV+LV:IFP<200THEN1000
976 IFP<300THEN3000
977 IFP<400THEN5000
6999 GOTO12990
12990 IFB=2ORB=11THENPRINT@256,"
NO EFFECT":PRINT@288," ":GOTO150
12991 IFB=8ANDC=6THENPRINT@288,"
IT'S ALREADY OPEN":GOTO150
12992 IFB=1ANDC=8ANDC(8)=1THENPR
INT@288,"CROSS-SHAPED":GOTO150
12993 IFB=1ANDC=6ANDC(6)=1THENPR
INT@288,"SMALL,LEATHER":GOTO150
12994 IFB=1ANDC=1ANDC(1)=1THENPR
INT@288,"SOLID BRONZE,3 FEET LON
G":GOTO150
12995 IFB=1ANDC=4ANDC(4)=1THENPR
INT@288,"NINE INCHES LONG,DOUBLE
SIDED BLADE":GOTO150
12997 IFB=1THENPRINT@288,"I DON'
T SEE ANYTHING SPECIAL":GOTO150
12998 PRINT@448,"I'M UNABLE TO D
O THAT NOW":GOTO150
12999 GOTO12990
15000 P=LV+HV+VV:PRINT@72,"":PRI
NT@96,"":PRINT@128,"":PRINT@160,
""
15010 AG=AG+.45:IFAG>20THENAG=20
15050 F=0:FORX=1TO20:IFC(X)=3 OR
C(X)=P THENPRINT@72+(F*8),C$(X)
:F=F+1:C(X)=3
15070 NEXTX
15080 FORX=1TO20:IFD(X)=3 OR D(X)
)=P THENPRINT@72+(F*8),D$(X):F=F
+1
15085 NEXTX
15100 N=0:S=0:V=0:W=0:D=0:U=0
15110 IFO=0ANDT=0THENPRINT@38,"-
-NONE--":GOTO150
15120 IFT=1THENU=1
15125 IFT=2THEND=1
15130 IFT=3THENU=1:D=1
15135 IFO=1THENN=1
15140 IFO=2THENS=1
15145 IFO=3THENV=1
15150 IFO=4THENW=1
15155 IFO=5THENN=1:S=1
15160 IFO=6THENN=1:V=1
15165 IFO=7THENN=1:W=1
15170 IFO=8THENS=1:V=1
15175 IFO=9THENS=1:W=1
15180 IFO=10THENV=1:W=1
15185 IFO=11THENN=1:S=1:V=1

```

```

15190 IFO=12THENN=1:S=1:W=1
15195 IFO=13THENN=1:V=1:W=1
15200 IFO=14THENS=1:V=1:W=1
15205 IFO=15THENN=1:S=1:W=1:V=1
15207 PRINT@38,""
15208 IFO=16ANDT=0THENPRINT@38,"
none":GOTO150
15210 IFN=1THENPRINT@38,"N"
15215 IFS=1THENPRINT@40,"S"
15220 IFV=1THENPRINT@42,"E"
15225 IFW=1THENPRINT@44,"W"
15230 IFU=1THENPRINT@46,"U"
15235 IFD=1THENPRINT@48,"D"
15240 GOTO150
25000 CLS:INPUT"PUT BLANK TAPE I
N RECORDER-PRESSPLAY AND RECORD-
PRESS <ENTER> WHEN READY";RE$
25010 FORY=1TO3:OPEN"O",#-1,"VAR
IABLE":FORX=1TO20:PRINT#-1,C(X):
NEXTX
25015 PRINT#-1,G,H,AG
25020 CLOSE#-1:NEXTY
25030 CLS:PRINT"THE VARIABLE TAP
E HAS BEEN SAVEDTHREE TIMES":PRI
NT"TO CONTINUE-CLOAD NEXT GAME A
ND FOLLOW THE DIRECTIONS":END
26000 CLS:INPUT"PUT TAPE WITH VA
RIABLES IN RE- CORDER-PRESS PLA
Y/PRESS <ENTER> WHEN READY";RE$:

```

## Co Co - Cooler



- Brings operating temperature to ambient, regardless of accessory load



- Reduces temperature of ENTIRE computer ... not just the SAM chip

- Easy 1-minute installation • \$39.95

Companion Keyboard Cover \$7.95  
Co Co Software

- For Fastest Service Send Money Order Or Certified Check
- Add \$2.00 Shipping For Continental U.S.
- Add \$4.00 Shipping For Alaska, Hawaii & Canada
- Add \$15.00 Shipping For Overseas
- Add \$3.00 For 220-250 Volt Model
- Calif. Residents Add 6½% Sales Tax
- Will Ship C.O.D. On U.S.A. Shipments Only
- All Merchandise Shipped From Stock

**REM Industries, Inc.**  
9420 "B" Lurline Ave., Chatsworth, CA 91311  
(213) 341-3719

```

OPEN"I",#-1,"VARIABLE"
26010 FORX=1TO20:INPUT#-1,C(X):N
EXT
26015 INPUT#-1,G,H,AG
26020 CLOSE#-1:FORX=1TO20
26025 IFC(X)<>1ANDC(X)<>2THENC(X
)=0
26030 NEXTX:GOTO110

```

Rainbow Check Plus		
1105	.....027D	139
3025	.....04B4	61
4007	.....06F0	27
4310	.....0A9D	210
5090	.....0D7B	21
6010	.....10FF	161
12997	.....1392	159
20089	.....1638	234
30140	.....194F	199
END	.....1C88	94

Listing 2

```

100 CLS(0):DIMB$(20),C$(20),C(20
),D$(20),D(20),A1$(25),A2$(25),A
3$(25),KA(12),AK(12)
110 CLS(0):D(17)=316:D(15)=316:D
(12)=323:D(11)=114:C(10)=114:AG=
20:AH=10:AI=10:D(8)=221:C(8)=221
:C(5)=2:C(6)=2:C(9)=1:H=1:C(1)=1
:C(2)=2:C(3)=2:C(4)=2:P=203:HV=0
:VV=3:LV=200
1000 IFMV=0THEN2000
1010 Q=P-LV:PRINT@9,A1$(Q)
1015 IFP=113THENO=1:T=2:D(4)=3:G
OTO15000
1020 IFP=112THENT=0:O=5:GOTO1500
0
1025 IFP=101THENO=8
1030 IFP=102THENO=5
1035 IFP=103THENO=5
1040 IFP=104THENO=5
1045 IFP=105THENO=6
1050 IFP=106THENO=10
1055 IFP=110THENO=10
1060 IFP=111THENO=14:GOTO15000
1065 IFP=114THENO=2:GOTO15000
1070 IFP=115THENO=13:GOTO15000
1075 IFP=116THENO=10
1080 IFP=120THENO=10
1085 IFP=121THENO=9
1090 IFP=122THENO=5
1095 IFP=123THENO=5
1100 IFP=124THENO=5
1105 IFP=125THENO=7
1999 GOTO30000
2000 IFB=1THEN2010ELSE2999
2010 IFJ=9THENIFD(9)=3ORD(9)=P T
HENPRINT@288,"DEAD":GOTO150
2020 IFJ=10THENIFD(10)=3ORD(10)=
P THENPRINT@288,"DEAD":GOTO150

```

```

2030 IFJ=11ANDP=114THENPRINT@288
,"LARGE,ORNATE,BRASS":GOTO150
2040 IFC=10THENIFC(10)=1ORC(10)=
3THENPRINT@288,"UNLIT,18 INCHES
LONG":GOTO150
2999 GOTO12990
3000 IFMV=0THEN4000
3010 Q=P-LV:PRINT@9,A2$(Q)
3011 IFP=203THENO=3:T=0
3012 IFP=203ANDK=0THENPRINT@288,
"A SOLID,METAL DOOR SLAMMED DOWN
AS I CAME IN-I CAN'T GO BACK":K
=1
3015 IFP=208ANDI=0THENPRINT@256,
"TO THE EAST IS A PIT,IN THE WAL
LIS A SLOT":D(1)=3:D(2)=3:O=4:T=
0
3020 IFP=208ANDI=1THENO=10:T=0:D
(2)=3
3025 IFP=209ANDM=0THENO=3:PRINT@
288,"CLOSED DOOR TO SOUTH":T=0:D
(6)=3
3030 IFP=209ANDM=1THENO=8:T=0
3035 IFP=210THENO=1:T=2:D(4)=3
3040 IFP=213THENO=9:T=1:D(4)=3
3045 IFP=214THENO=13:T=0
3050 IFP=216THENO=8:T=0
3055 IFP=217ANDR=0THENPRINT@288,
"BOLTS FROM EVERYWHERE HIT ME!":
FORX=1TO3000:NEXT:CLS:PRINT@264,
N$:END
3060 IFP=217THENO=5:T=0:D(5)=3
3065 IFP=218ANDR=0THEND(5)=3:PRI
NT@288,"IN THE WALLS TO THE NORT
H ARE MANY SMALL HOLES":O=5:T=
0
3067 IFP=218ANDR=1THENO=5:T=0
3070 IFP=219THENO=7:T=0
3075 IFP=221THENO=4:T=0:PRINT@28
8,"THERE IS A TABLE IN THE CORNE
R":IFC(8)=221 ORC(8)=3THENPRINT@
320,"ON IT IS A KEY"
3999 GOTO15000
4000 '
4001 IFP=203ORP=208THENIFB=1ANDC
=7THENIFC(7)=1THENPRINT@288,"SMA
LL,SOLID GOLD":GOTO150
4005 IFP=208THEN4007ELSE4050
4007 IFB=1THEN4010ELSE4020
4010 IFJ=1THENPRINT@288,"DEEP,DA
RK":GOTO150
4015 IFJ=2THENPRINT@288,"1 INCH
WIDE,1/4 INCH HIGH":GOTO150
4020 IFB=3ANDF$=D$(2)ANDC=7ANDC(
7)=1THENPRINT@256,"CLINK":PRIN
T@288,"":FORX=1TO2000:NEXT:PRIN
T@288,"A BRIDGE SLID FROM THE FA
R PIT WALL":C(7)=4:O=10:I=1:H=H
-1:D(3)=3:GOTO15000
4050 IFP=218THEN4055ELSE4100

```



# 624 KBYTE SYSTEM!



**ONLY \$499<sup>00</sup>**  
(Including 2 Diskettes)

**New  
3" disk  
cartridge**

## AMDISK YOUR COLOR COMPUTER®

Get 312 Kbytes\* of on-line, formatted storage capacity for your Color Computer with the Amdisk-III. The Amdisk-III is a disk drive system that combines the capacity and compatibility of 5 1/4" floppies with the convenient size and ruggedness of the state-of-the-art in technology — the 3" microfloppy cartridge.

Join the move to maximize your Color Computer's power and "Amdisk" it. Many software vendors have joined, and will be providing software on Amdisk's 3" cartridge upon request. These software suppliers are: Cognitec; Computerware; Frank Hogg Laboratories; The MicroWorks; Tom Mix Software; Moreton Bay Software; Nelson Software Systems; Petrocci Freelance Associates; Prickly Pear Software; Saguaro Software; Skyline Marketing; The Software Station; Spectrum Projects; Star-Kits and Sugar Software.

You can purchase the Amdisk-III from any of these fine dealers:

Computerware: (619) 436-3512  
Delker Electronics: (615) 459-2636  
Emerald Computer: (800) 468-4606  
Saguaro Software: (602) 885-6508  
Skyline Marketing: (312) 286-0762  
Spectrum Projects: (212) 441-2807  
The Software Station: (313) 532-2650

or ask for the Amdisk-III at your local computer dealer.

\* An additional 312 Kbytes may be accessed by manually flipping the media over.

® Color Computer is a registered trademark of Tandy Corporation.

22011 Nely Blvd. • Elk Grove Village, IL 60007  
(312) 364-1180 • TLX 25-4786

REGIONAL OFFICES: Southern Calif. (714) 662-3949 • Texas (817) 496-2334  
Northern Calif. (408) 370-9370 • Denver (303) 794-3477

**AMDEK**



# PRICKLY-PEAR SOFTWARE

## QUALITY PROGRAMS FOR YOUR COCO & TDP-100

PROGRAMS REQUIRE 16K EXTENDED BASIC FOR TAPE, AND 32K DISK UNLESS OTHERWISE NOTED.

### FOUR GREAT NEW PROGRAMS

#### Varalyzer

A breakthrough in programming utilities from the author of Colorkit! You may need a little background for this program. The first time you mention a variable in a BASIC program, the computer assigns a space in the variable table in memory. It starts at the bottom of the table and works up to the top, and the next time that variable is called in your program the computer goes to the variable table to look it up. The search starts at the bottom of the table and continues until the variable is located. This takes time, and the farther up the table the variable is located, the longer it takes. There is a **BIG SPEED ADVANTAGE** in having the most frequently called variable located first in the table, with the next most frequently called variable second, etc. This program simply examines your BASIC program while it is running and then actually modifies it to speed it up! Speed increase will be from 5% to 75%, depending upon the program, and we include a list of other tips to speed up execution even more. This program will also print a list of the variables used in the program and tell you how many times each is called. VARALYZER is 100% machine language and **REQUIRES 64K** to run. Works fine on either disk or tape systems. **\$24.95**



#### Clone Master

This is the ultimate disk backup utility, and who else but Prickly-Pear, originators of Omni-Clone, could bring it to you. If you are tired of waiting for your BACKUP command to finish, you'll like the speed of CLONE MASTER. This program checks the computer memory size, and if you have a 64K machine it will do a backup on a full disk in about 7 minutes — including formatting the destination disk — with only **THREE** swaps, not the seven you are used to, and if you are running multiple drives, CLONE MASTER will handle up to 4 double-sided drives. In addition, although we can't guarantee that CLONE MASTER will back up any disk, it can handle backups of any non-standard (protected) disk we have seen — not only on the Color Computer, but on Model III and IV, IBM PC, Kaypro, Osborne, and Atari. It handles up to 256 tracks, single and double density — even on the same track. CRC errors, and lots more. It even checks the speed of your drives for you! If you are using a disk drive, you know how disks will crash, so don't leave your valuable software unprotected any longer. Back it up or lose it! CLONE MASTER will adjust to any memory size and works with any version of the ROM's — including the JVC controller. **\$39.95**

Your personal check is welcome - no delay. Include \$1.50 shipping for each program ordered. (Shipping free on \$50.00 or larger orders). AZ residents add 7% sales tax. Orders shipped within two days.

#### Erland

The most complex simulation we have ever seen, and you VIKING! fans will want to take note. This game has you running a small holding in old Ireland. You must manage your land, sheep, army, markets, fishing fleets, taxes, and many other factors while you try to rise in rank to become King or Queen. You may attack — or be attacked — by the other players, and you will have to face the fact that there isn't enough land to go around, and you may have to take some away from someone else! This 32K game is considerably more complex and difficult than our super popular VIKING! Because of this, we have added a save-the-game feature. ERLAND is for 2 to 5 game lovers, and will warm the heart of anyone who liked VIKING!, Monopoly, or other classic strategy games. This game is a hybrid of Extended Basic and Machine language. The disk and tape versions are not interchangeable. **Tape — \$24.95; Disk — \$29.95**



#### Satellite Tracker

#### Satellite Tracker

If you are interested in reception of transmissions from the television satellites, you will need this program. It does all calculations associated with planning and setting up a satellite dish antenna. It figures antenna gain, signal to noise, aiming point for any geosynchronous satellite, effect of various quality amplifiers, and a lot more. The program will tell you whether a dish is practical in your location, how big it needs to be, and what kind of picture quality and signal strength you will achieve. If you are thinking of investing in a system, don't make a move until the results are in. Requires 32K extended BASIC and some (limited) knowledge of satellite terms and language. **\$79.95**



Dealer and author inquiries are always welcome. Canadian dealers should contact Kelly Software Distributors, Ltd., P. O. Box 1 1932, Edmonton, Alberta T5J-3L1 (403) 421-8003

Stocked by Quality Dealers, or

Send Order To: **PRICKLY-PEAR SOFTWARE**  
9234 E. 30th Street  
Tucson, Arizona 85710  
(602) 886-1505



```

4055 IFB=1THEN4060ELSE4075
4060 IFJ=5ANDR=0THENPRINT@288,"S
HARP POINT IN EACH":GOTO150
4065 IFJ=5ANDR=1THENPRINT@288,"A
LL ARE EMPTY":GOTO150
4075 IFB=9ANDC=9THENPRINT@320,"W
HICH DIRECTION(N S E W U D)":INP
UTO$:IFO$="N"THENPRINT@352,"BOLT
S FLEW OUT OF THE HOLES AND HARM
LESSLY HIT THE WALLS":R=1:C(9)=2
17:GOTO150:ELSEC(9)=3:GOTO15000
4100 IFP=209THEN4110ELSE4300
4110 IFB=1ANDJ=6THENPRINT@288,"H
EAVY WOOD,BLACK METAL LOCK":D(7)
=3:GOTO15000
4120 IFB=8ANDJ=6ANDAA=0THENPRINT
@288,"WON'T OPEN":GOTO150
4130 IFB=8ANDJ=6THENPRINT@288,"I
T SWUNG INWARD":M=1:O=8:GOTO1500
0
4140 IFB=10ANDJ=7THENPRINT@288,"
WITH WHAT":INPUTP$:IFP$="KEY"AND
C(8)=1THENPRINT@288,"IT IS UNLOC
KED":AA=1:GOTO150
4150 IFB=1ANDJ=7THENPRINT@288,"C
ROSS SHAPED OPENING":GOTO150
4300 IFP=221THEN4310ELSE4999
4310 IFB=1ANDJ=8THENPRINT@288,"A
SMALL,THREE LEGGED TABLE WITH A
DRAWER":D(18)=3:GOTO15000
4320 IFB=1ANDJ=18ANDD(18)<>0ANDA
N=1THEN4325ELSE4340
4325 IFC(11)=0ORC(11)=3THENPRINT
@288,"A JADE PENDANT":C(11)=3:GO
TO15000
4330 PRINT@288,"EMPTY":GOTO150
4340 IFB=8ANDJ=18THENPRINT@288,"
IT IS OPEN":AN=1:GOTO150
4345 IFB=1ANDC=11ANDC(11)=1THENP
RINT@288,"TURTLE":GOTO150
4999 GOTO12990
5000 IFMV=0THEN6000
5010 IFC(10)=1ORC(10)=3THENIFAK=
1THENQ=P-LV:PRINT@9,A3$(Q):AL=0:
GOTO5020
5015 PRINT@9,"too dark to see":A
L=1
5020 IFP=310ANDAL=1THEN0=16:T=1:
GOTO15000
5030 IFP=310THEN0=3:T=1:D(4)=3
5040 IFAL=1THENPRINT@288,"SOMETH
ING HEAVY SPRANG OUT AT MEAND KN
OCKED ME TO THE FLOOR":FORX=1TO1
500:NEXT:PRINT@352,"I CANNOT FIG
HT IT OFF-IT IS RIP-PING ME APAR
T!":FORX=1TO3500:NEXT:CLS:PRINT@
263,N$:END
5050 IFP=315THEN0=10:T=0:D(14)=0
5060 IFP=320THEN0=7
5070 IFP=324THEN0=7

```

```

5080 IFP=319THEN0=8
5090 IFP=323THEN0=2:PRINT@288,"A
BUBBLING POOL OF MOLTEN SULFURB
LOCKS MY WAY-THERE IS A PASSAGET
O THE NORTH BEYOND"
5100 IFAM=0ANDP=322THEN0=4:D(14)
=4:PRINT@288,"THE LIZARD SUNK FR
OM SIGHT":D(12)=3
5110 IFP=322THEN0=4:D(12)=3
5115 IFP=317THEN0=6
5120 IFP=316THEN0=8:PRINT@288,"T
HERE IS A PATH TO THE EAST AND A
LEDGE HIGH UP ON THE WEST WALL"
5125 IFP=321THENPRINT@288,"I HEA
R A SCREECHING SOUND FROM OVERH
EAD!!??":FORX=1TO2500:NEXT:PRINT
@352,"A HUGE HARPY HAS ME IN IT'
S GRIP":FORX=1TO2500:NEXT:PRINT@
384,"IT'S LIFTING ME UP!":FORX=1
TO2000:NEXT:PRINT@416,"IT DROPPE
D ME!":FORX=1TO2000:NEXT
5130 IFP=321THENPRINT@448,"THUD!
!":FORX=1TO1000:NEXT:PRINT@9,"LE
DGE":PRINT@38,"none":PRINT@69,""
:PRINT@96," ":PRINT@128," ":PRIN
T@288,"THIS IS THE END OF PART 1
WAIT A MOMENT PLEASE":PRI
NT@352," ":PRINT@384," ":PRINT@4
16," "
5135 IFP=321THENPRINT@448," ":FO
RX=1TO5000:NEXT:GOTO25000
5999 GOTO15000
6000 IFB=1ANDJ=13ANDP=323THENIFD
(13)=3ORD(13)=323THENPRINT@288,"
THEY ARE FINNED":IFD(14)=0THENFO
RX=1TO2000:NEXT:PRINT@320,"A LAR
GE LIZARD IS COMING OUT OF THE P
OOL!":D(14)=3:GOTO15000ELSE150
6010 IFB=1ANDJ=12ANDP=323THENPRI
NT@288,"ABOUT 15 FEET ACROSS,THE
RE ARE TRACKS COMING FROM AND G
OING TO IT":D(13)=3:GOTO15000
6020 IFB=1ANDJ=14ANDP=323ANDD(14)
<>0THENPRINT@288,"YELLOW,ABOUT
20 FEET IN LENGTH":GOTO150
6030 IFP=323THENIFB=2ORB=11THENI
FD(14)<>0THENPRINT@288,"THE LIZA
RD RETURNED TO THE POOL":D(14)=4
:GOTO15000
6040 IFP=323ANDB=13ANDJ=14THENPR
INT@288,"WHAT":INPUTFO$:IFFO$=C$
(5)ANDC(5)=1THENPRINT@320,"THE L
IZARD ATE AND WENT TO THE POOL-
IT IS SPANNING THE POOL WITH
IT'S BODY":O=5:H=H-1:C(5)=0:GOTO
15000
12990 REM
12991 IFB=8ANDC=6THENPRINT@288,"
IT'S ALREADY OPEN":GOTO150
12992 IFB=1ANDC=8ANDC(8)=1THENPR

```

```

INT@288, "CROSS-SHAPED":GOTO150
12993 IFB=1ANDC=6ANDC(6)=1THENPR
INT@288, "SMALL, LEATHER":GOTO150
12994 IFB=1ANDC=1ANDC(1)=1THENPR
INT@288, "SOLID BRONZE, 3 FEET LON
G":GOTO150
12995 IFB=1ANDC=4ANDC(4)=1THENPR
INT@288, "NINE INCHES LONG, DOUBLE
SIDED BLADE":GOTO150
12997 IFB=1THENPRINT@288, "I DON'
T SEE ANYTHING SPECIAL":GOTO150
12998 PRINT@448, "I CAN'T":GOTO15
0
12999 GOTO12990
20000 DATA LOOK, HIT, PUT, GET, LIST
, DROP, VIEW, OPEN, THROW, UNLOCK, STA
B, LIGHT, FEED, ZZ, ZZ, ZZ, ZZ, ZZ, ZZ, Z
Z
20020 DATA SWORD, FLINT, ROPE, DAGG
ER, JERKY, POUCH, COIN, KEY, SACK, TOR
CH, PENDANT, 12, 13, 14, 15, 16, 17, 18,
19, 20
20040 DATA PIT, SLOT, BRIDGE, STAIR
S, HOLES, DOOR, LOCK, TABLE, DRAGON, B
OAR, THRONE, POOL, TRACKS, LIZARD, LE
DGE, HARPY, PATH, DRAWER, ZZ, ZZ
20049 REM A2$( )
20050 DATA 201, 202, HALL, 204, 205,
206, 207, HALL, HALL, LARGE ROOM

```

```

20055 DATA 211, 212, LOBBY, HALL, 21
5, HALL, HALL, HALL, HALL, 220
20060 DATA SMALL CUBICLE, 222, 223
, 224, 225
20069 REM A1$( )
20070 DATA HALL, HALL, HALL, HALL, H
ALL, HALL, 107, 108, 109, HALL
20075 DATA HALL, HALL, LANDING, THR
ONE ROOM, HALL, HALL, 117, 118, 119, H
ALL
20080 DATA HALL, HALL, HALL, HALL, H
ALL
20089 REM A3$( )
20090 DATA 301, 302, 303, 304, 305, F
ISSURE, 307, 308, 309, ROCK TUNNEL
20095 DATA LEDGE, 312, 313, 314, TUN
NEL, VAST CAVERN, TUNNEL, 318, TUNNE
L, TUNNEL
20100 DATA ???, CAVERN, CAVERN, TUN
NEL, 325
20120 DATA 1514, 11, 1515, 1, 1516, 1
8, 1517, 18, 1518, 1, 1519, 11, 1520, 45
, 1521, 16, 1522, 1, 1523, 18, 1524, 20,
1525, 49
30000 IFAB=1ANDAC=1THENAE=0:AF=0
:GOTO15000
30010 X=RND(-TIMER)
30015 X=RND(100):IFX>40THEN15000
30020 X=RND(200):IFX>100THEN3050
0
30100 IFAC=1ANDC(10)=114THEN1500
0
30103 IFAB=1THEN15000
30105 AJ=0
30110 O=16:T=0:PRINT@384, "AN EME
RALD-GREEN DRAGON IS NOW ATTACK
ING":AE=1:D(9)=3
30115 AG=INT(AG):PRINT@288, "OPPO
NENT'S STRENGTH=":PRINT@320, " KA
RRACK'S STRENGTH=":PRINT@308, AI:
PRINT@340, AG
30120 IFB=2ANDH%=C$(1) THENX=RND(
100):IFX>40THENPRINT@448, "A SOLI
D HIT!":AH=AH-5:ELSEPRINT@448, "M
ISSED-THE DRAGON DIDN'T":AG=AG-4
30140 IFB=11ANDH%=C$(4) THENX=RND
(100):IFX>40THENPRINT@448, "JUST
CAUGHT IT!":AH=AH-2:ELSEPRINT@44
8, "DRAGON SWIPED MY CHEST!":AG=A
G-2
30160 IFB<>2ANDB<>11 THENPRINT@25
6, "THE DRAGON'S TAIL HIT ME!":AG
=AG-2
30200 PRINT@308, AH:PRINT@340, AG
30300 IFAH<1 THENPRINT@256, "THE D
RAGON IS DEAD":PRINT@384, " ":PRI
NT@416, " ":O=AJ:AB=1:AE=0:GOTO15
000
30400 IFAG<1 THENPRINT@256, N$:FOR
X=1TO2000:NEXT:CLS:END

```

#### UPLOAD

\$16.95

This is the UPLOAD side of DLOAD and DLOADM in Extended Color Basic. Send a basic or machine program to another ECB Color Computer. Programs can be passed directly or by phone if both computers are hooked to modems.(not supplied). Uploaded program arrives at the receiving end ready to save, run, or execute. Patch to correct the flaw in DLOADM is supplied in public domain.

#### INDEXER

\$14.95

Program produces a sorted list of variables and line numbers used in your basic program. Following each variable or line number will be a listing of the numbers of the basic lines which contain the variable or line number. RUNNING the basic program is not required. Bonus! Global search of basic program for a variable, a text string, or a basic keyword.

Fast machine language

16K/32K EXTENDED BASIC, Tape or RS Disk

Add \$2.00 for shipping and handling



ML-US'R SOFTWARE  
115 RISING SUN, Dept R  
FORT MITCHELL, KY 41017



```

30499 GOTO15000
30500 IFAB=1ANDC(10)=114THEN1500
0
30505 IFAC=1THEN15000
30507 AJ=0
30510 O=16:T=0:PRINT@384,"A WILD
BOAR IS NOW ATTACKING":D(10)=3:
AF=1
30515 AG=INT(AG):PRINT@288,"OPPO
NENT'S STRENGTH=":PRINT@320," KA
RRAK'S STRENGTH=":PRINT@308,AH:P
RINT@340,AG
30520 IFC(1)=1THENIFB=2THENX=RND
(100):IFX>40THENPRINT@448,"A SOL
ID BLOW!":AI=AI-5:ELSEPRINT@448,
"A TUSK CAUGHT MY LEG":AG=AG-3
30530 IFC(4)=1THENIFB=11THENX=RN
D(100):IFX>30THENPRINT@448,"A SL
IGHT WOUND IN IT'S NECK":AI=AI-2
:ELSEPRINT@448,"IT'S HOOF RIPPED
MY LEG":AG=AG-2
30535 PRINT@308,AI:PRINT@340,AG
30540 IFB<>2ANDB<>11THENPRINT@44
8,"IT'S TEETH CUT MY ANKLE":AG=A
G-2
30550 IFAI<1THENPRINT@256,"THE B
OAR IS DEAD":PRINT@384," ":AC=1:
O=AJ:AF=0:GOTO15000
30560 IFAG<1THENPRINT@288,H$:FOR
X=1TO2000:NEXT:CLS:END
30999 GOTO15000

```

Rainbow  
Check  
Plus

1040	.....033D	0
1100	.....0692	191
2100	.....08BD	50
3090	.....0BFE	111
5170	.....0F58	251
6030	.....119B	12
20020	.....14B4	53
30110	.....1813	69
30300	.....1B90	60
END	.....1E52	203

Listing 3

```

100 CLS(0):DIMB$(20),C$(20),C(20
),D$(20),D(20),A1$(25),A2$(25),A
3$(25),KA(12),AK(12)
110 CLS(0):C(7)=301:AH=15:AI=10:
C(7)=301:C(5)=124:D(1)=123:P=123
:HV=20:VV=3:LV=100
1000 IFMV=0THEN2000
1001 Q=P-LV:PRINT@9,A1$(Q)
1010 IFP=123THENIFC(10)=3ORC(10)
=P THENO=4:D(1)=3:PRINT@288,"THE
RE IS A FISSURE IN THE ROCK TO
THE WEST-JUST WIDE ENOUGH TO ENT
ER. THE TORCH WENT OUT-BUT ITIS
LIGHT ENOUGH TO SEE WITHOUT IT"
:GOTO15000
1013 IFP=123THENO=4:D(1)=3
1015 IFP=118THENO=6:PRINT@288,"V

```

```

ERY NARROW HERE"
1020 IFP=117THENO=8
1025 IFP=122THENO=7:PRINT@288,"B
ARELY ENOUGH ROOM TO MOVE"
1030 IFP=121THENO=9:IFBA=0THENPR
INT@288,"A LITTLE WIDER HERE":BA
=1
1035 IFP=116THENO=10:T=0:D(2)=3:
D(1)=3:D(3)=3:IFBC=0THENPRINT@28
8,"I'M AT THE BEGINNING OF A PAT
H- IT WINDS HIGH ALONG THE WALL
OF ANOTHER VAST CAVERN- ALONG TH
E FLOOR TO THE SOUTH RUNS A RED
- COLORED RIVER":BC=1
1040 IFP=111THENO=10:T=2:D(3)=3:
D(4)=3:PRINT@288,"STEPS LEAD DOW
N"
1045 IFP=106THENO=10:T=0:D(3)=3
1050 IFP=101THENO=8:D(3)=3
1055 IFP=102THENO=5:T=0:D(3)=3
1060 IFP=103THENO=5:T=2:D(3)=3:D
(4)=3:PRINT@288,"STEPS LEAD DOWN
. TO THE EAST IS THE RIVER IN TH
E CAVERN FLOOR"
1065 IFP=104THENO=5:D(3)=3:T=0:D
(7)=3:PRINT@288,"TO THE EAST I S
EE WHAT LOOKS TO BE A TEMPLE.IT
IS IN A CLEFT OF ROCK IN THE CAV
ERN WALL"
1070 IFP=105THENO=6:D(3)=3:PRINT
@288,"TO THE EAST IS A SHAFT- TO
THE NORTHEAST IS THE RIVER IN
THE CAVERN FLOOR":D(5)=3
1075 IFP=110THENO=10:PRINT@288,"
TO THE WEST IS A PATH":D(2)=3
1080 IFP=115THENO=10
1085 IFP=120THENO=7:T=0
1090 IFP=119ANDBD=0THEND(5)=3:O=
2:T=2:PRINT@288,"THE SHAFT SLANT
S DOWNWARD.IN THEEAST WALL IS A
DOOR":D(6)=3:GOTO15000
1095 IFP=119THENO=8:D(5)=3:T=2:P
RINT@288,"THE SHAFT SLANTS DOWNW
ARD.TO THEEAST IS AN OPEN DOOR":
D(6)=3
1100 IFP=124THENO=4:T=0:IFC(5)=3
ORC(5)=P THENPRINT@288,"AN IDOL
RESTS IN A NICHE IN THE SOUTH WA
LL":C(5)=3:D(8)=3:ELSEPRINT@288,
"THE NICHE IS EMPTY":D(8)=3:GOTO
15000
1999 GOTO15000
2000 REM
2010 IFB=1THEN2020ELSE2200
2020 IFD(J)=3ORD(J)=P THEN2030EL
SE2200
2030 IFJ=1THENPRINT@288,"TALL,NA
RROW":GOTO150
2035 IFJ=8THENPRINT@288,"CARVED
OUT OF THE WALL":GOTO150

```

A Dictionary Program is Useless  
Unless It's Perfect.  
That's Why We Are Introducing

# SPELL 'N FIX II

A Spelling Dictionary Program is supposed to help you catch and fix mistakes in word processing text. It should be simple and convenient to use. It should be fast. And above all, it must be accurate.

SPELL 'N FIX is all of these. But now SPELL 'N FIX II is even better! Look at the comparison chart to see why.

SPELL 'N FIX II finds and fixes spelling and typing errors in a single pass. As SPELL 'N FIX II proofreads your text, you see it all (in full upper and lower case) right on the screen. When a suspect word is found, you see it in context as part of the text. You can immediately search the SPELL 'N FIX II dictionary for the correct spelling, and put the right word into your text in a flash.

Most important of all, we take great pains to make sure that SPELL 'N FIX is accurate and complete. SPELL 'N FIX II comes with a 20,000+ word standard dictionary which contains many more words than the average person uses. By allowing you to add your own words, SPELL 'N FIX II gives you the advantage of a short, fast dictionary that can contain all the words you use (including your name and address, special words from your business, and even foreign or coined words.) We don't stuff our dictionary with useless words (some with foreign spellings or downright wrong like absorbancy, accidently, acct's, agcy, aix, or analyse as you find in other programs' 60,000 word dictionaries.)

Regardless of which you choose — the original SPELL 'N FIX (available on tape or disk, for 16K or larger computers, now at a new low price with generous upgrade terms), or the new SPELL 'N FIX II — you will understand why we say

## COMPARISON CHART

	Radio Shack Color Dictionary 26 3265	Original SPELL 'N FIX	New SPELL 'N FIX II
Checks SCRIPSIT (R) files	YES	YES	YES
Checks other text processor files	NO	YES	YES
Checks Basic data files	NO	YES	YES
Checks files larger than memory	NO	YES	YES
Full upper and lower case display	NO	NO	YES
Add words to dictionary	NO	YES	YES
Delete words from dictionary	NO	YES	YES
Custom dictionaries possible	NO	YES	YES
Comes with error-free dictionary	NO	YES	YES
Usable for foreign languages	NO	YES	YES
Checks and fixes in one pass	NO	NO	YES
Shows suspect words in context	YES	YES	YES
Usable with just one diskette	NO	YES	YES
Looks up words in dictionary	YES	NO	YES
Looks up words while correcting	NO	NO	YES
DIR command allowed during run	NO	YES	YES
Uses standard Basic file format	NO	YES	YES
Price	\$59.95	\$49.99	\$69.29

(Note: SCRIPSIT is a trademark of Tandy Corporation)

**A Dictionary Program is Useless Unless It's perfect.  
SPELL 'N FIX Perfect!**

## STAR — KITS

P.O. BOX 209 — R  
MT. KISCO, N.Y. 10549  
(914) 241-0287

## STAR — KIBBITS

It seems like just yesterday that I wrote the first Star — Kibbits column (though it wasn't called that then — I called it "A Word From the Sponsor"). But here it is — a whole year later. Time does fly!

### ?IO ERROR

Familiar message on your disk system? Perhaps the problem is noise. Let me explain.

A few weeks ago, I was asked by a local businessman to check out one of his four CoCos. I went to his office, and found that one of his Radio Shack drives was making a lot of errors.

We disconnected the drive and went to a local Radio Shack service center. Imagine my surprise (and embarrassment) when the drive worked perfectly on their test bench. Back to the office and more IO errors.

After some headscratching (not much hair to get in the way), I decided that Radio Shack drives must be very sensitive to external magnetic fields, and that this drive was picking up noise from the motor of a blower he had installed to keep his CoCo cool. We placed the drive to the right of the computer, on a small dish rack from the local 5-and-10, and his problems went away.

When you think about it, the read-write head in a disk drive works on very low level magnetic fields, and can easily pick up noise from nearby electric motors or transformers. The MPI drives I am using on my own system have a small copper shield near the head; the drives don't work very well at all if you accidentally leave it out. Some drive manufacturers even tell you not to mount two drives next to each other, since they will pick up noise from each other's motors.

Though this particular drive seemed more sensitive than most, still it's not surprising that where you put the drive can make a big difference. If you are having problems with IO errors, try moving the drive far away from everything else. It might help.

### DOUBLE — SIDED DISKS

We are selling a complete disk system with a disk controller, a double-sided 40-track drive, cabinet, power supply and all cables, all for \$400. The advantage, of course, is that the double-sided drive gives you the capacity of two regular drives for just slightly more than only one.

If you currently have a double-sided drive, send us a large self-addressed stamped envelope and we will send you free details on how to use it with your CoCo.

That's it for this month — see you next time.

## SPELL 'N FIX II

Regardless of whose text processor you use, "let SPELL 'N FIX II" find and fix your spelling and typing mistakes. It reads text faster than you can, and spots and corrects errors even experienced proofreaders miss. It is compatible with all Color Computer text processors. \$69.29 in the Radio Shack disk or cassette versions; \$178.58 in the Flex version. Older SPELL 'N FIX I is now priced at just \$49.95. Both include a 20,000 word dictionary.

## HUMBUG — THE SUPER MONITOR

A complete monitor and debugging system which lets you input programs and data into memory, list memory contents, insert multiple breakpoints, single-step, test, checksum, and compare memory contents, find data in memory, start and stop programs, upload and download, save to tape, connect the Color Computer to a terminal, printer, or remote computer, and more. HUMBUG on disk or cassette costs just \$39.95, special 64K version for FLEX or STAR-DOS 64 costs \$59.95, MC-10 version \$29.95

## STAR-DOS

A Disk Operating System specially designed for the Color Computer, STAR-DOS is fully compatible with your present Color Computer disk format — it reads disks written by Extended Disk Basic and vice versa. STAR-DOS for 16K or 32K systems costs \$49.90; STAR-DOS 64 for 64K systems costs \$74.90

## ALL IN ONE — Editor Etc.

Three programs in one — a full function Editor, a Text Processor and a Mailing List Label program. All this for just \$50. Requires STAR-DOS or FLEX, specify which.

## DBLS for Data Bases

DBLS stands for Data Base Lookup System. A super-fast system for searching for a selected record in a sequential disk file. Supplied with SPELL 'N FIX's 20,000 word dictionary as a sample data file — lets you look up the spelling of any word in under FOUR seconds. Priced at \$29.95. Requires STAR-DOS.

## CHECK 'N TAX

Home accounting package combines checkbook maintenance and income tax data collection. Written in Basic for either RS Disk or Flex. \$50

## REMOTERM

REMOTERM — makes your CoCo into a host computer, operated from a remote terminal. \$19.95, disk or cassette.

## NEWTALK

NEWTALK — a memory examine utility for machine language programmers which reads out memory contents through the TV set speaker. \$20, disk or cassette.

## SHRINK

SHRINK — our version of Eliza, in machine language and extremely fast. \$15, disk or cassette.

## EDUCATIONAL SOFTWARE

Introduction to Numerical Methods — college level course on computer math, \$75.00, disk or cassette.

We accept cash, check, COD, Visa, or Master Card. NY State residents please add appropriate sales tax. Add \$3 to above price for AMDEK 3" disk versions.

(FLEX is a trademark of Technical Systems Consultants, Inc. Everything else in this ad is a trademark of Star-Kits.)

# STAR-KITS

P.O. BOX 209 — R  
MT. KISCO, N.Y. 10549  
(914) 241-0287

```

2040 IFJ=2THENPRINT@288,"ROUGH R
OCK,NARROW":GOTO150
2050 IFJ=3THENPRINT@288,"DEEP-RE
D COLOR,FUMES RISING FROMIT'S SU
RFACE":GOTO150
2060 IFJ=4THENPRINT@288,"CHISELL
ED FROM THE CAVERN WALL, STEEP":
GOTO150
2070 IFJ=5THENPRINT@288,"MAN OR
CREATURE-MADE.A STRANGE GLOW EM
ANATES FROM IT'S SURFACE":GOTO15
0
2080 IFJ=6THENPRINT@288,"BRONZE,
MASSIVE,A TURTLE CAST IN RELIEF
AT THE CENTER":GOTO150
2090 IFJ=7THENPRINT@288,"MUCH TO
O FAR AWAY TO SEE ANY DE-TAIL":G
OTO150
2100 GOTO12990
2200 IFP=119ANDBD=0ANDB=8ANDJ=6T
HENPRINT@288,"'CREAK' ":FORX=1TO1
000:NEXT:PRINT@320,"THE DOOR IS
OPEN-":BD=1:O=8:T=2:GOTO15000
2210 IFB=1ANDC=5ANDC(5)=1THENPRI
NT@288,"A JADE TURTLE":GOTO150
2999 GOTO12990
3000 IFMV=0THEN4000
3001 Q=P-LV:PRINT@9,A2$(Q)
3005 GOTO3025
3008 X=RND(100):IFX<70THEN3010EL
SE15000
3010 PRINT@384,"AN ARROW CAME FR
OM":X=RND(2):IFX=1THENPRINT@403,
"ABOVE":ELSEPRINT@403,"BELOW"
3011 X=RND(3):IFX=1THENPRINT@416
,"IT MISSED ME":ELSEIFX=2THENPRI
NT@416,"IT HIT MY ARM":AG=AG-5:E
LSEPRINT@416,"IT HIT MY LEG":AG=
AG-73014 IFAG<1THENPRINT@448,"KA
RRAK IS DEAD":FORX=1TO3000:NEXT:
CLS:END
3015 GOTO15000
3025 IFP=211ORP=203THENPRINT@288
,"I'M IN THE MIDDLE OF THE STEPS
":T=3:O=16:D(3)=3:GOTO3008
3040 IFP=219ANDBE=1THENPRINT@288
,"THE STONE IS BLOCKING THE WAY
UP":O=16:T=2:D(9)=3:GOTO15000
3050 IFP=219THENX=RND(100):IFX>2
0THEN3090
3060 T=2:O=16:PRINT@288,"'THUD' "
:FORX=1TO2000:NEXT:PRINT@320,"A
LARGE STONE FELL-BLOCKING THE WA
Y BACK UP":BE=1:D(9)=3:GOTO15000
3090 T=3:O=16:PRINT@288,"THE SHA
FT RUNS UP AND DOWN"
3999 GOTO15000
4000 REM
4999 GOTO12990
5000 IFMV=0THEN6000

```

```

5001 Q=P-LV:PRINT@9,A3$(Q)
5010 IFP=302THENIFBG=0THENAF=1:O
=11:T=0:GOTO30500
5015 IFP=306THENIFBG=0THENAF=1:O
=9:T=0:GOTO30500
5025 IFP=323THENIFBF=0THENAE=1:D
(11)=3:B=11:C=0:J=0:H=C$(4):O=5
:AJ=0:GOTO160
5030 IFP=301THEN0=8
5040 IFP=302THEN0=11:T=0
5050 IFP=303THEN0=1:T=1:D(4)=3
5060 IFP=306THEN0=9
5070 IFP=307THEN0=12
5080 IFP=308THEN0=6:D(3)=3
5090 IFP=311THEN0=2:T=1:D(4)=3
5100 IFP=312THEN0=11:T=0:D(3)=3:
D(7)=3
5110 IFP=313THEN0=7:D(3)=3
5120 IFP=319THEN0=2:T=1:D(5)=3:P
RINT@288,"THE SHAFT SLOPES UPWAR
D"
5130 IFP=320THEN0=6:T=0
5140 IFP=316THEN0=8:D(7)=3:D(3)=
3:PRINT@288,"THE RIVER IS TO THE
EAST-ON THE OTHER SIDE IS THE T
EMPLE"
5150 IFP=317THEN0=7:D(7)=3:D(3)=
3
5160 IFP=321THEN0=4:D(7)=3:D(3)=
3:PRINT@288,"THE RIVER IS TO THE
SOUTH,THE CAVERN WALLS TO THE
NORTH AND EAST"
5170 IFP=322THENPRINT@9,"TEMPLE"
:PRINT@38,"NONE":PRINT@288,"THIS
IS THE END OF PART 2 WAIT
A MOMENT PLEASE":PRINT@69," ":P
RINT@96," ":PRINT@128," ":FORX=1
TO5000:NEXT:GOTO25000
5180 IFP=323THEN0=5:D(4)=3
5190 IFP=324ANDBF=0THEN0=5:D(4)=
3:D(11)=3:PRINT@288,"THERE IS A
GOBLIN STANDING GUARDON THE TEMP
LE STEPS TO THE NORTH":GOTO15000
5195 IFP=324THEN0=5:D(4)=3:D(11)
=3:IFC(12)=0THENC(12)=3
5196 IFP=324THEND(7)=3:IFC(13)=0
THENC(13)=3
5200 IFP=325THEN0=7
5999 GOTO15000
6000 REM
6005 IFB=1THENIFD(J)=3ORD(J)=P T
HEN6010ELSE6050
6010 IFJ=3THENPRINT@288,"BOILING
LAVA":GOTO150
6015 IFJ=4THENPRINT@288,"ROUGH,H
AND-HEWN":GOTO150
6020 IFJ=7THENPRINT@288,"STONE B
LOCKS,A TURTLE CARVED OVER TH
E ENTRANCE":GOTO150
6025 IFJ=11THENIFBF=1THENPRINT@2

```



```

88, "DEAD":GOTO150:ELSEPRINT@288,
" FIERCE LOOKING,LEATHER ARMOR,
  ARMED WITH A MACE AND HAND AX":
GOTO150
6030 IFJ=12THENPRINT@288, "DEAD":
GOTO150
6050 IFB=1ANDC=7ANDC(7)=1THENPRI
NT@288, "SOLID GOLD,EMBOSSD WITH
MANY SMALL TURTLES":GOTO150
6060 IFB=1ANDC=12ANDC(12)=1THENP
RINT@288, "TWO FEET LONG,LARGE BR
ASS HEAD WITH SHARP SPIKES":GOT
O150
6070 IFB=1ANDC=13ANDC(13)=1THENP
RINT@288, "ONE FOOT LONG,STONE HE
AD":GOTO150
12990 REM
12991 IFB=8ANDC=6THENPRINT@288, "
IT'S ALREADY OPEN":GOTO150
12992 IFB=1ANDC=8ANDC(8)=1THENPR
INT@288, "CROSS-SHAPED":GOTO150
12993 IFB=1ANDC=6ANDC(6)=1THENPR
INT@288, "SMALL,LEATHER":GOTO150
12994 IFB=1ANDC=1ANDC(1)=1THENPR
INT@288, "SOLID BRONZE,3 FEET LON
G":GOTO150
12995 IFB=1ANDC=4ANDC(4)=1THENPR
INT@288, "NINE INCHES LONG,DOUBLE
SIDED BLADE":GOTO150

```

```

12997 IFB=1THENPRINT@288, "I DON'
T SEE ANYTHING SPECIAL":GOTO150
12998 PRINT@448, "I CAN'T":GOTO15
O
12999 GOTO12990
20000 DATA LOOK,HIT,PUT,GET,LIST
,DROP,VIEW,OPEN,THROW,UNLOCK,STA
B,LIGHT,FEED,ZZ,ZZ,ZZ,ZZ,ZZ,ZZ,Z
Z
20020 DATA SWORD,FLINT,ROPE,DAGG
ER,IDOL,POUCH,CHALICE,KEY,SACK,T
ORCH,PENDANT,MACE,HAND AX,14,15,
16,17,18,19,20
20040 DATA FISSURE,PATH,RIVER,ST
EPS,SHAFT,DOOR,TEMPLE,NICHE,STON
E,ZZ,GOBLIN,WOLF,ZZ,ZZ,ZZ,ZZ,ZZ,
ZZ,ZZ,ZZ
20049 REM A2$( )
20050 DATA 201,202,STEPS,204,205
,206,207,208,209,210
20055 DATA STEPS,212,213,214,215
,216,217,218,SHAFT,220
20060 DATA 221,222,223,224,225
20069 REM A1$( )
20070 DATA PATH,PATH,PATH,PATH,P
ATH,PATH,107,108,109,SHAFT
20075 DATA PATH,112,113,114,SHAF
T,PATH,FISSURE,FISSURE,SHAFT,SHA
FT

```

**TRS-80  
COMPUTERS**

**Transtar**

AMDEK 3" SYSTEM  
\$595 COMPLETE!

DISK DRIVES!! DISK DRIVES!! DISK DRIVES!!

- DISK DRIVE 0:
1. TEC FB501 (6 MON. WARRANTY) \$365
  2. TEAC FD55A (1 YR. WARRANTY) \$395
  3. QUME TRAK 142 (AVAILABLE IN DUAL CABINET ONLY-6 MON. WARRANTY) \$415
  4. TANDON TM55 (6 MON. WARRANTY) \$395
  5. TANDON TM100-1A (6 MON. WARRANTY) \$385
  6. SHUGART SA-405 (9 MON. WARRANTY) \$395

NOTE: DRIVES INCLUDE RADIO SHACK OR J&M CONTROLLER, SILVER-GREY OR WHITE CABINET, 3 DISKETTES, MANUAL AND DISK UTILITY PROGRAMS.



64K COLOR COMPUTER 2 \$295  
64K COLOR COMPUTER 26-3003B \$305

COMPUTERWARE\*BUGGERS GROWING SYSTEMS\*SPECTRAL\*MORETON BAY\*MARK DATA\*COMPUTER SHACK\*MSI\*COGNITEC\*STARKITS\*K & K\*DOUBLE DENSITY \*DERRINGER\*TOM MIX\*MTP\*VIDTRON\*PRICKLY PEAR\*EIGEN\*EVS\*ADVENTURE INTERNATIONAL\*YGS(CANADA)\*WICO\*DATASOFT\*FHL\*LEADING EDGE\*HJL\*AARDVARK\*SILVERWARE\*PCSG(MODEL 100)\*TRAVELLING SW(MODEL 100)\*SPECTRUM\*CERCOMP\*PROGRAMMERS INSTITUTE\*ELITE\*RADIO SHACK\*SOFTLAW\*HOMEBASE\*INTERACTION\*SKYLINE\*50 SW SYS\*CUSTOM SW ENGRG\* SUPERIOR GRAPHIC SW\*RAINBOW\*COCO MAG\*HOT COCO\*COCONEWS

SPECIAL!! SPECIAL!! SPECIAL!!

\*\*\*\*\*

64K COLOR COMPUTER 2  
TEC DISK DRIVE 0  
GORILLA MONITOR (AMBER OR GREEN)  
MANNESMAN-TALLY SPIRIT PRINTER  
\*\*\*\*\* \$1 0 9 5 \*\*\*\*\*

DEALER INQUIRIES WELCOME!!

EMERALD COMPUTER SERVICES 'NORTHWEST'S COLOR COMPUTER STORE'  
4401 219TH SW MOUNTLAKE TERRACE, WASH. 98043  
206-778-9826 OPEN: TUES-FRI 10-8 SAT. NOON-6

**stair**  
TELETYPE

**EPSON**

**Okidata**

**C. Itoh**

**DRAGON 64  
by Tano**

**MORROW  
DESIGNS**

**panasonic**

```

20080 DATA FISSURE,FISSURE,LEDGE
,VAULT,125
20089 REM A3$( )
20090 DATA CAVERN FLOOR,CAVERN F
LOOR,CAVERN FLOOR,304,305,CAVERN
FLOOR,CAVERN FLOOR,CAVERN FLOOR
,309,310
20095 DATA CAVERN FLOOR,CAVERN F
LOOR,CAVERN FLOOR,314,315,CAVERN
FLOOR,CAVERN FLOOR,318,CAVERN F
LOOR,CAVERN FLOOR
20100 DATA CAVERN FLOOR,TEMPLE,T
EMPLE STEPS,CAVERN FLOOR,CAVERN
FLOOR
20120 DATA 1514,11,1515,1,1516,1
8,1517,18,1518,1,1519,11,1520,45
,1521,16,1522,1,1523,18,1524,20,
1525,50
30000 REM
30105 AJ=0
30110 O=16:T=0:PRINT@384,"THE GO
BLIN IS ATTACKING":AE=1:D(11)=3
30115 AG=INT(AG):PRINT@288,"OPPO
NENT'S STRENGTH=":PRINT@320," KA
RRACK'S STRENGTH=":PRINT@308,AI:
PRINT@340,AG
30120 IFB=2ANDH$=C$(1)THENX=RND(
4):IFX=1THENPRINT@256,"WE BOTH H
IT":AH=AH-3:AG=AG-3:ELSEIFX=2THE
NPRINT@256,"I HIT HIM":AH=AH-3:E
LSEIFX=3THENPRINT@256,"I MISSED-
HE DIDN'T":AG=AG-3:ELSEPRINT@256
,"WE BOTH MISSED"
30125 IFB=11ANDH$=C$(4)THENX=RND
(4):IFX=1THENPRINT@256,"WE BOTH
STRUCK":AH=AH-2:AG=AG-2:ELSEIFX=
2THENPRINT@256,"I GOT HIM":AH=AH
-2:ELSEIFX=3THENPRINT@256,"HE CL
UBBED ME":AG=AG-2:ELSEPRINT@256,
"WE BOTH MISSED"
30126 IFB=11ANDH$=C$(4)ORB=2ANDH
$=C$(1)THEN30130
30127 PRINT@256,"HE HIT MY ARM W
ITH HIS HAND AX":AG=AG-2:GOTO302
00
30130 X=RND(100):IFX>97THENPRINT
@416,"I TRIPPED,HE SMASHED MY SK
ULL KARRAK IS DEAD":PRINT@340,
"O":FORX=1TO5000:NEXT:CLS:END
30135 X=RND(100):IFX>96THENPRINT
@416,"HIS MACE SLIPPED OUT OF HI
S HANDI SKEWERED HIM CLEANLY":AH
=0
30200 PRINT@308,AH:PRINT@340,AG
30250 IFAG<1ANDAH<1THENPRINT@416
,"BOTH THE GOBLIN AND KARRAK ARE
DEAD":FORX=1TO2500:NEXT:CLS:EN
D
30300 IFAH<1THENPRINT@256,"THE G
OBLIN IS DEAD":PRINT@384," ":C(1

```

```

2)=3:C(13)=3:O=AJ:BF=1:AE=0:GOTO
15000
30400 IFAG<1THENPRINT@256,N$:FOR
X=1TO2000:NEXT:CLS:END
30499 GOTO15000
30500 REM
30505 IFAC=1THEN15000
30507 AJ=0
30510 O=16:T=0:PRINT@384,"A WOLF
IS ATTACKING":D(12)=3:AF=1
30513 IFH$=C$(13)THENH$=C$(4)
30514 IFH$=C$(12)THENH$=C$(1)
30515 AG=INT(AG):PRINT@288,"OPPO
NENT'S STRENGTH=":PRINT@320," KA
RRAK'S STRENGTH=":PRINT@308,AH:P
RINT@340,AG
30520 IFC(1)=1ORC(12)=1THENIFB=2
THENX=RND(100):IFX>40THENPRINT@4
48,"A SOLID BLOW!":AI=AI-5:ELSEP
RINT@448,"IT'S TEETH SLASHED MY
LEG":AG=AG-3
30530 IFC(4)=1ORC(13)=1THENIFB=1
1THENX=RND(100):IFX>30THENPRINT@
448,"A SLIGHT WOUND IN IT'S NECK
":AI=AI-2:ELSEPRINT@448,"IT'S TE
ETH RIPPED MY ARM":AG=AG-2
30535 PRINT@308,AI:PRINT@340,AG
30540 IFB<>2ANDB<>11THENPRINT@44
8,"IT'S TEETH CUT MY ANKLE":AG=A
G-2
30550 IFAI<1THENPRINT@256,"THE W
OLF IS DEAD":PRINT@384," ":BG=1:
O=AJ:AF=0:GOTO15000
30560 IFAG<1THENPRINT@288,H$:FOR
X=1TO2000:NEXT:CLS:END
30999 GOTO15000

```

Rainbow  
Check  
Plus

1080	..... 0292	12
2061	..... 052C	234
3003	..... 0795	36
3999	.... 0AB0	87
5080	..... 0E6F	42
20049	.... 1262	78
30120	.... 165B	169
30510	.... 196C	219
END	.... 1D4A	218

Listing 4

```

100 CLS(0):DIMB$(20),C$(20),C(20
),D$(20),D(20),A1$(25),A2$(25),A
3$(25),KA(12),AK(12)
110 CLS(0):AI=12:LV=100:HV=0:VV=
5:P=105:AH=12
1000 IFMV=0THEN2000
1001 Q=P-LV:PRINT@9,A1$(Q)
1002 IFP=105THEN1010
1003 X=RND(4):IFX=4THENGOSUB5000
0:PRINT@457,"-AND RAN OFF"
1010 IFP=105ANDCA=0THENPRINT@288
,"A DWARF SLAMMED THE TEMPLE DOO

```

```

R SHUT AND RAN OFF TO THE NORTH"
:0=1:T=0:D(1)=3:CA=1:GOTO15000
1015 IFP=105THEND(1)=3:0=1
1020 IFP=101THENO=2:T=2:D(2)=3
1030 IFP=102THENT=0:0=5
1040 IFP=103ANDCB=0THENO=5:D(1)=
3:PRINT@288,"THERE IS A CLOSED D
OOR TO THE EAST":GOTO15000
1050 IFP=103THENO=11:D(1)=3:PRIN
T@288,"THE DOOR TO THE EAST IS O
PEN"
1060 IFP=104THENO=5
1070 IFP=108THENO=10
1080 IFP=113THENO=10:T=0:D(3)=3:
PRINT@288,"THROUGH AN ARCHWAY TO
THE EAST, ISEE AN ALTAR"
1090 IFP=118ANDCD=0THENO=4:D(3)=
3:D(4)=3:PRINT@288,"I AM AT THE
ALTAR, IT IS AT THE TOP OF FIVE
STEPS":GOTO15000
1100 IFP=118THENO=4:T=2:PRINT@28
8,"THE HIDDEN STAIRWAY IS VISIBL
E":D(2)=3:D(3)=3
1999 GOTO15000
2000 REM
2010 IFP=105ANDB=8ANDJ=1THENPRIN
T@288,"WON'T BUDGE":GOTO150
2020 IFB=1THENIFD(J)=3ORD(J)=P T
HEN2030
2025 GOTO2100
2030 IFJ=1ANDP=105THENPRINT@288,
"SOLID BRONZE, A TURTLE IN RELIEF
IN THE CENTER":GOTO150
2035 IFJ=1ANDP=103 OR J=1ANDP=10
8THENPRINT@288,"OAK, HEAVY BLACK
METAL STRAPS":GOTO150
2040 IFP=118ANDJ=3THEN2045ELSE20
60
2045 IFCD=1THENPRINT@352,"STEPS
LEAD DOWN"
2050 PRINT@288,"TURTLE SHAPE, FOU
R LEGS, HEAD+TAIL-ABOUT 20 FEET L
ONG, THREE HIGH":D(9)=3:D(10)=3:D
(11)=3:GOTO15000
2060 IFP=118THEN2061ELSE2100
2061 IFJ=9THENPRINT@288,"MOUTH O
PEN, RUBY INSIDE":D(12)=3:GOTO150
00
2065 IFJ=11THENPRINT@288,"JUST A
TAIL MADE OF STONE":GOTO150
2070 IFJ=10THENPRINT@288,"FIVE G
OLD CLAWS ON EACH FOOT":D(13)=3:
GOTO15000
2080 IFJ=13THENPRINT@288,"GOLD, T
HREE INCHES LONG":GOTO150
2090 IFJ=2THENPRINT@288,"HAND HE
WN":GOTO150
2095 IFJ=12THENPRINT@288,"FIVE I
NCHES THICK, FACETED":GOTO150
2100 IFP=118ANDB=12ANDJ=14ANDCI=

```



## OWLS NEST SOFTWARE

WE GIVE A HOOT



**LABELIII** (Reviewed in Nov. 83 Rainbow)  
With LABELIII you can develop and maintain a mailing list. Display on screen or printer. Print lists or labels in your choice of 1, 2, or 3 wide. Supports 3 or 4 line addresses with phone optional. Fast machine language sort on last name, first name, or zip code.  
Cassette 16K EXT - Postpaid \$19.95



**ATLANTIS ADVENTURE**  
This one is tough! We challenge you to complete this in 30 days. If you can we will send you any cassette program we sell at no charge. (We will even pay the postage.) You start on a disabled sub, near the lost city of Atlantis. Your object is to get the sub and yourself safely to the surface.  
Cassette 16K EXT - Postpaid \$21.95



**ADVENTURE STARTER PACKAGE**  
Learn to play those adventures the painless way. You start with a simple adventure and then move into an intermediate. We also include hints and tips on adventuring. Your 16K EXT cassette includes both "MYHOUSE" and "PIRATES" adventures. Finish this and you are ready for "ATLANTIS."  
Cassette 16K EXT - Postpaid \$17.95



**FOUR MILE ISLAND ADVENTURE**  
You are trapped inside a disabled nuclear Power Plant. The reactor is running away. You must bring the reactor to a cold shutdown and prevent the "China Syndrome." Can you save the plant (and yourself)? It's not easy!  
Cassette 16K EXT - Postpaid \$17.95



**ESPIONAGE ISLAND ADVENTURE**  
You have been dropped off on a deserted island by a submarine. You must recover a top secret microfilm and signal the sub to pick you up. Problems abound in this 32K text adventure.  
Cassette 32K EXT - Postpaid \$17.95



**PROGRAM FILE** (Reviewed in Oct. 83 Rainbow)  
Organize your cassette programs. Let your computer find that program for you. Create and maintain a four field file. You can search, sort, modify, delete and display on screen or printer. Sorting may be done by name, type or location.  
Cassette 16K EXT - Postpaid \$14.95



**OWLS EYE INDICATOR LIGHT**  
Don't leave your coco on and fry your chips! The OWLS EYE plugs into either joystick port and may be mounted beside the keyboard where it is easily visible. Simple 10 second installation! We pay first class postage in the USA and Canada.  
OWLS EYE - Postpaid \$ 8.95



**SPORTS CAR ADVENTURE**  
An easy to intermediate text adventure that requires you to fix that "old Junker" in the garage. You don't have to be a mechanic but you are going to have to "fine tune" your wits.  
Cassette 16K EXT - Postpaid \$12.95

CASSETTE TAPES C-06 \$7.50 dozen/\$9.50 dozen with hard boxes. Please add \$1.50 per dozen shipping and handling.

\* C.O.D. orders please add \$1.50  
\* No delay for personal checks



OWLS NEST SOFTWARE

P.O. Box 579  
Ooltewah, TN 37363

```

OTHENCI=1:D(12)=0:CD=1:PRINT@288
,"'CLICK'":FORX=1TO1000:NEXT:PRI
NT@320,"THE ALTAR MOVED BACK-REV
EALING STEPS LEADING DOWN":D(2)
=3:T=2:GOTO15000
2110 IFP=103ANDB=8ANDCB=0THENPRI
NT@288,"'UUMMMMPH'":FORX=1TO1500
:NEXT:PRINT@320,"HEAVY-BUT I GOT
IT OPEN":O=11:CB=1:GOTO15000
2999 GOTO12990
3000 IFMV=0THEN4000
3001 Q=P-LV:PRINT@9,A2$(Q)
3002 IFP=218ORP=208ORP=203THEN30
10
3003 X=RND(5):IFX=5THENGOSUB5000
0:PRINT@457,"-AND RAN OFF"
3010 IFP=201THENO=3:T=1:D(2)=3
3020 IFP=206THENT=0:O=10
3030 IFP=211THENO=10
3040 IFP=216THENIFCE=1THENPRINT@
288,"THE PANEL IS OPEN":D(5)=3:O
=10:GOTO15000ELSEPRINT@288,"THE
HALL ENDS":O=4
3050 IFP=221THENO=9:D(5)=3:T=0:I
FCE=0THENCE=1:PRINT@288,"A PANEL
IN THE WEST WALL OPENED AS I AP
PROACHED"
3060 IFP=222THENO=1:T=2:D(2)=3
3070 IFP=203THENPRINT@288,"THE W
HOLE ROOM IS COVERED WITH A GRE
EN OOZE":FORX=1TO2000:NEXT:PRINT
@320,"A HUGE GLOB FELL ON ME FRO
M THE CEILING!! I CAN'T BREATHE!
!":FORX=1TO3500:NEXT:CLS:PRINT@2
65,N$:END
3080 IFP=208AND CF=1THENO=10:PRI
NT@288,"THE CELL DOOR IS OPEN":D
(1)=3:GOTO15000
3085 IFP=208THENO=3:PRINT@288,"T
HERE IS A DOOR TO THE WEST,THE O
PENING NEAR THE TOP IS BARRED":D
(1)=3:D(16)=3
3090 IFP=213THENO=10:T=0
3100 IFP=218THENO=4:T=2:IFCG=0TH
ENPRINT@288,"I HEARD LAUGHTER-AN
D THE ALTAR MOVED BACK-THE WAY
UP IS BLOCKEDSOMEHOW I THINK THE
DWARF DID IT":CG=1:CD=0:CI=0:D(
12)=118
3999 GOTO15000
4000 REM
4010 IFP=216ANDB=13ANDJ=15ANDCE=
0THENPRINT@288,"'RUMBLE'":FORX=1
TO1000:NEXT:PRINT@320,"A PANEL I
N THE EAST WALL SWUNG OPEN":D(5)
=3:O=10:CE=1:T=0:GOTO15000
4020 IFB=13ANDJ=15THENPRINT@288,
"NOT DOING ANYTHING HERE":GOTO15
0
4030 IFP=208ANDCF=0ANDB=8ANDJ=1T

```

```

HENPRINT@288,"THE DOOR OPENED IN
WARD":CF=1:O=10:GOTO15000
4040 IFP=208ANDJ=1ANDB=1THENPRIN
T@288,"ON THE DOOR IS A WARNING-
--- 'WHAT IS WITHIN IS MEANT
TO STAYTHERE FOREVER-DISTURB IT
NOT'":GOTO150
4050 IFP=208ANDB=1ANDJ=16THENPRI
NT@288,"THE ENTIRE INSIDE OF THE
ROOM ISCOVERED WITH A GREENISH
OOZE":D(17)=3:GOTO150
4999 GOTO12990
5000 IFMV=0THEN6000
5001 Q=P-LV:PRINT@9,A3$(Q)
5002 IFP=307ORP=317THENIFAC=0THE
NPRINT@352,"I HEAR SOMETHING RAT
TLING AHEAD!"
5003 IFP=312ORP=313THEN5010ELSEX
=RND(5):IFX=5THENGOSUB50000:PRIN
T@457,"-AND RAN OFF"
5010 IFP=322THENO=4:T=1:D(2)=3:P
RINT@288,"THE STAIRS LEAD UP"
5020 IFP=317THENO=10:T=0
5030 IFP=312ANDAC=0THENAF=1:GOTO
30500THENO=10
5040 IFP=312THENO=10
5050 IFP=307THENO=8
5060 IFP=308THENO=5
5070 IFP=309THENO=6
5080 IFP=314THENO=13:IFAB=0THENP
RINT@288,"I HEAR SOMETHING MOVIN
G AROUND TO THE NORTH-WHATEVER
IT IS-IT DOESN'T CARE IF IT IS
HEARD"
5090 IFP=319THENO=7:T=0
5100 IFP=313ANDAB=1THENO=0:T=0:P
RINT@69," ":PRINT@96," ":PRINT@1
28," ":PRINT@288,"THIS IS THE EN
D OF PART THREE PLEASE WAIT A
MOMENT-":FORX=1TO5000:NEXT:GOTO2
5000
5105 IFP=313THENO=2:T=0:AE=1:GOT
030000
5110 IFP=318THENO=2:T=1:D(2)=3:C
G=1:PRINT@288,"I THINK I HEARD T
HE DWARF ABOVE"
5999 GOTO15000
6000 REM
12990 IFB=20RB=11THENPRINT@256,"
NO EFFECT":PRINT@288," ":GOTO150
12991 IFB=8ANDC=6THENPRINT@288,"
IT'S ALREADY OPEN":GOTO150
12992 IFB=1ANDC=8ANDC(8)=1THENPR
INT@288,"CROSS-SHAPED":GOTO150
12993 IFB=1ANDC=6ANDC(6)=1THENPR
INT@288,"SMALL,LEATHER":GOTO150
12994 IFB=1ANDC=1ANDC(1)=1THENPR
INT@288,"SOLID BRONZE,3 FEET LON
G":GOTO150
12995 IFB=1ANDC=4ANDC(4)=1THENPR

```

INT@288, "NINE INCHES LONG, DOUBLE  
 SIDED BLADE":GOTO150  
 12997 IFB=1THENPRINT@288, "I DON'  
 T SEE ANYTHING SPECIAL":GOTO150  
 12998 PRINT@448, "I CAN'T":GOTO15  
 0  
 12999 GOTO12990  
 20000 DATA LOOK, HIT, PUT, GET, LIST  
 , DROP, VIEW, OPEN, THROW, UNLOCK, STA  
 B, CLOSE, PUSH, ZZ, ZZ, ZZ, ZZ, ZZ, ZZ, Z  
 Z  
 20020 DATA SWORD, FLINT, ROPE, DAGG  
 ER, IDOL, POUCH, CHALICE, KEY, SACK, T  
 ORCH, PENDANT, MACE, HAND AX, 14, 15,  
 16, 17, 18, 19, 20  
 20040 DATA DOOR, STAIRS, ALTAR, STE  
 PS, PANEL, SKELETON, TEMPLE, TURTLE,  
 HEAD, LEGS, TAIL, RUBY, CLAWS, MOUTH,  
 WALL, BARS, OOZE, RAT, ZZ, ZZ  
 20049 REM A2\$( )  
 20050 DATA STAIRWAY, 202, CELL, 204  
 , 205, HALL, 207, PASSAGE, 209, 210  
 20055 DATA HALL, 212, PASSAGE, 214,  
 215, HALL, 217, STAIRWAY, 219, 220  
 20060 DATA HALL, STAIRWAY, 223, 224  
 , 225  
 20069 REM A1\$( )  
 20070 DATA STAIRWAY, CORRIDOR, COR  
 RIDOR, CORRIDOR, INSIDE TEMPLE ENT

RANCE, 106, 107, ANTEROOM, 109, 110  
 20075 DATA 111, 112, MAIN MEETING  
 ROOM, 114, 115, 116, 117, ALTAR, 119, 1  
 20  
 20080 DATA 121, 122, 123, 124, 125  
 20089 REM A3\$( )  
 20090 DATA 301, 302, 303, 304, 305, 3  
 06, TUNNEL, TUNNEL, TUNNEL, 310  
 20095 DATA 311, TUNNEL, CAVERN, TUN  
 NEL, 315, 316, TUNNEL, STAIRWAY, TUNN  
 EL, 320  
 20100 DATA 321, STAIRWAY, 323, 324,  
 325  
 20120 DATA 1514, 11, 1515, 1, 1516, 1  
 8, 1517, 18, 1518, 1, 1519, 11, 1520, 45  
 , 1521, 16, 1522, 1, 1523, 18, 1524, 20,  
 1525, 51  
 30000 REM  
 30105 AJ=0  
 30107 IFAG<10THENAG=14  
 30110 D(18)=3:O=16:T=0:PRINT@384  
 , "A HUGE RAT IS ATTACKING":AE=1  
 30112 IFB=2ANDH\$=C\$(12)THENH\$=C\$  
 (1)  
 30113 IFB=11ANDH\$=C\$(13)THENH\$=C  
 \$(4)  
 30115 AG=INT(AG):PRINT@288, "OPPO  
 NENT'S STRENGTH=":PRINT@320, " KA  
 RRACK'S STRENGTH=":PRINT@308, AI:

## Two Great New Programs

From Creative Technical Consultants, an established leader in educational software for the Color Computer.

- ☆ **MUSICAL STRINGS.** An entertaining tutorial that stimulates musical creativity and teaches basic computer string variable concepts. After an animated lesson about string variables and an introduction to the Extended Basic PLAY statement, this program turns the keyboard into a piano and lets you create your own musical strings to add to your favorite programs or to simply listen to. The on-screen menus and instructions and the clear, easy-to-understand language make this program great for everyone from 10-year-olds to adults . . . . . \$17.95
- ☆ **CUSTOM FLASHCARDS.** This great study aid lets you quickly create and save your own sets of flashcards about any subject, in any format. You can store as many sets as you need on tape, and recall them later (like at semester exam time) to study by "flipping" through them on the computer screen. It's simple to use, with complete menus and instructions on the screen, a flexible card format, four study options, and unlimited storage. Anyone age 12 and up can create and study flashcards with this program, while children down to age 8 can use it to study flashcards created by a teacher or parent . . . . . \$17.95

### OTHER BEST SELLERS BY CREATIVE TECHNICAL CONSULTANTS

- ★ **ALPHABET SOUP.** A word recognition and spelling game for the whole family . . . . . \$15.95
- ★ **COLOR MATH QUIZ, DECIMAL MATH QUIZ, and FRACTION MATH QUIZ.** A trio of math drill programs featuring five skill levels, multiple choice answer formats, and entertaining music and graphics to keep ages 4 (with help) to 16 interested . . . . . each \$15.95 or all three for \$42.95

ALL PROGRAMS ARE ON CASSETTE FOR THE COLOR COMPUTER OR TDP-100 WITH A MINIMUM OF 16 K OF MEMORY AND EXTENDED BASIC.

SEND CHECK, MONEY ORDER  
 OR PURCHASE ORDER, PLUS

\$2.00 SHIPPING AND HANDLING TO:

CREATIVE TECHNICAL CONSULTANTS  
 P.O. Box 652 Cedar Crest, NM 87008

```

PRINT@340,AG
30120 IFB=2ANDH$=C$(1)THENX=RND(
4):IFX=1THENPRINT@256,"I GOT HIM
AND IT BIT ME":AH=AH-3:AG=AG-3:
ELSEIFX=2THENPRINT@256,"I HIT HI
M":AH=AH-3:ELSEIFX=3THENPRINT@25
6,"I MISSED-HE DIDN'T":AG=AG-3:E
LSEPRINT@256,"WE BOTH MISSED"
30125 IFB=11ANDH$=C$(4)THENX=RND
(4):IFX=1THENPRINT@256,"I DREW B
LOOD-AS DID HE":AH=AH-2:AG=AG-2:
ELSEIFX=2THENPRINT@256,"I GOT HI
M":AH=AH-2:ELSEIFX=3THENPRINT@25
6,"HE BIT MY FLANK":AG=AG-2:ELSE
PRINT@256,"WE BOTH MISSED"
30126 IFB=11ANDH$=C$(4)ORB=2ANDH
$=C$(1)THEN30130
30127 PRINT@256,"IT BIT A CHUNK
FROM MY ARM":AG=AG-2:GOTO30200
30130 X=RND(100):IFX>97THENPRINT
@416,"I TRIPPED,HE TORE OPEN MY
CHEST KARRAK IS DEAD":PRINT@340,
"0":FORX=1TO5000:NEXT:CLS:END
30135 X=RND(100):IFX>96THENPRINT
@416,"IT SLIPPED ON THE WET FLOO
R-I FINISHED IT OFF":AH=0
30200 PRINT@308,AH:PRINT@340,AG
30250 IFAG<1ANDAH<1THENPRINT@416
,"BOTH THE RAT AND KARRAK ARE DE

```

```

AD":FORX=1TO2500:NEXT:CLS:END
30300 IFAG<1THENPRINT@256,"THE R
AT IS DEAD":PRINT@384," ":O=AJ:B
F=1:AE=0:D(18)=3:AB=1:FORX=1TO20
00:NEXT:GOTO5100
30400 IFAG<1THENPRINT@256,N$:FOR
X=1TO2000:NEXT:CLS:END
30499 GOTO15000
30500 REM
30505 IFAC=1THEN15000
30507 AJ=0
30510 O=16:T=0:PRINT@384,"A SKEL
ETON IS ATTACKING-IT HAS ASWORD"
:D(6)=3:AF=1
30515 AG=INT(AG):PRINT@288,"OPPO
NENT'S STRENGTH=":PRINT@320," KA
RRAK'S STRENGTH=":PRINT@308,AH:P
RINT@340,AG
30520 IFC(1)=1ANDB=2THENX=RND(10
0):IFX>50THENPRINT@448,"I HIT IT
":AI=AI-3:ELSEPRINT@448,"IT SLAS
HED MY ARM":AG=AG-5
30525 IFC(12)=1ANDB=2THENX=RND(1
00):IFX>30THENPRINT@448,"I SMASH
ED A FEW BONES":AI=AI-5:ELSEPRIN
T@448,"IT CUT MY LEG":AG=AG-5
30530 IFC(4)=1ANDB=11THENPRINT@4
48,"THE DAGGER ISN'T GOING TO HE
LP"
30535 IFC(13)=1ANDB=11THENX=RND(
100):IFX>50THENPRINT@448,"'CRUNC
H":AI=AI-3:ELSEPRINT@448,"IT CU
T MY ARM":AG=AG-2
30540 IFB<>2ANDB<>11THENPRINT@44
8,"IT CUT MY NECK":AG=AG-2
30541 PRINT@308,AI:PRINT@340,AG
30550 IFAI<5THENPRINT@256,"THE S
KELETON RAN AWAY":PRINT@416," ":
PRINT@384," ":O=AJ:AF=0:AC=1:D(6
)=0:GOTO15000
30560 IFAG<1THENFORX=1TO2000:NEX
T:CLS:PRINT@264,N$:END
30570 GOTO150
30999 GOTO15000
50000 CH=CH+1:IFCH<4THENPRINT@41
6,"THE DWARF THREW A ROCK AND HI
T":X=RND(3):IFX=1THENPRINT@448,"
MY HEAD":RETURNELSEIFX=2THENPRIN
T@448,"MY LEG":RETURN:ELSEIFX=3T
HENPRINT@448,"MY BACK":RETURN
50010 IFCH<6THENPRINT@384,"THAT
PESKY DWARF IS STILL AROUNDHE JU
ST SHOT AN ARROW AT ME-IT MISSE
D":RETURN
50020 IFCH<10THENPRINT@416,"THAT
DWARF IS A PAIN-HE GESTURED RUDE
LY":RETURN
50030 PRINT@416,"THE DWARF MUST
BE TIRING,HE JUST APPEARED":RETUR
N

```

**DON JUAN  
NEVER HAD IT SO EASY  
——— BUT YOU CAN**

**RATE YOUR DATES BY PERSONALITY,  
SEX, LOOKS AND WEALTH ——— ALSO ANY  
PERSONAL INFORMATION YOU MAY WANT**

**ALL THIS INFORMATION AT THE TOUCH  
OF YOUR FINGERTIPS INSTANTLY  
(((WHILE YOU'RE ON THE PHONE)))  
AND MANY OTHER FEATURES**

**LET YOUR COCO KEEP YOU ON TRACK  
WITH  
DATE MATE  
DISK ONLY \$14.95**



**COCOHUT  
931 WALLING  
HOUSTON, TX 77009**

**\* PLEASE SPECIFY THE SIZE OF YOUR SYSTEM**

# ColorQuest™ Games

Fast Machine Code • Hi-res Color Graphics • Exciting Arcade Action and Sound

For Orders  
ONLY Call  
Toll Free

# 1-800-328-2737

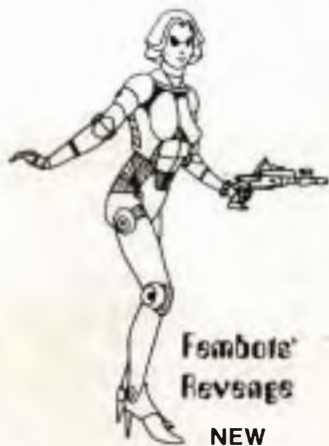

**Fembots' Revenge**

**NEW**

### 3-D GRAPHIC ADVENTURE

Shooting aliens on a flat screen is nothing like BEING THERE. In machine-code 3-D excitement, highest resolution graphics and sound, you are face to face with the Guardians: the ubiquitous Fembots, the powerful Arthroks and the omnipotent Optikon. Your lasgun blasting, you hear the explosion and the crunching metal; you feel the tension as you stalk your enemy, searching for the Destruct Button on your way to the Master Bay of the Mother Ship. Can you find the means to teleport to safety?

**32K Tape \$24.95 32K Disk \$29.95**



Coming Soon

## THE SENTINEL

3-D GRAPHIC ADVENTURE

A dark, awful secret is hidden in the cavernous labyrinth. Beyond the chasms, the poisonous gasses, Tunnels of No Return and the relentless minions, the Sentinel hungrily awaits! Sorcerous magick and saintly swordplay are your best friends and worst enemies. You are no ordinary warrior in this ultra hi-res, 3-D medieval adventure! Can you survive to discover the secret - or is there a seat in the netherworld for you too?

**32K Tape \$24.95 32K Disk \$29.95**



## Fyr-Draca

NEW ARCADE GAME

Fyr-Draca (Fire Dragons), from egg to the daemonic behemoth, greet you in five waves with nine colors on the screen at one time! This machine code game is going to sweep the Color Computer market. It is by far, the best game to come out for a long, long time. The real arcade look is here at last!

Fire Dragons uses the nine color mode to create a screen of dazzling color with a black background and a black border. Dragons swoop from their stellar watch, singly, in groups and in squadron formation. First you face the single wyrms, then the squadron, next the twin giants, followed by the Battle Drake and its minions. Even with four star vessels and shields you will be hard put to survive their spitting fire and diving attacks!

**32K Tape \$24.95 32K Disk \$29.95**



## BEYOND THE CIMEEON MOON

3-D GRAPHIC ADVENTURE

A dead star... A derlict vessel... or is it? Trapped within you must venture the corridors; defend yourself against the merciless gauntlet of agents of the machine mind. A real-time, high-res, 3-D science fiction adventure game of mind-blowing magnitude.

**16K Tape \$24.95 32K Disk \$29.95**



## Xygooid

**NEW**

Your ship is being enshrouded by the Xygooid Web. Certain death is minutes away! You must blast through the enveloping Web and destroy the Xygooid vessel before you are crushed. This is a multi-colored machine-code game in the highest resolution mode on a black background. Xygooid, from the galactic beginning! It will ensnare your mind!

**16K Tape \$19.95 32K Disk \$24.95**



## KOMET-KAZE

Another arcade hit! The Asteroid Belt is crashing down on Earth. You are the first-line defense. You must destroy the blazing asteroids and the homing orbs with your disruptor. Machine-code speed, multi-colors on a black background - the crash and explosions of the asteroids rain on your senses!

**16K Tape \$19.95 32K Disk \$24.95**

## INTERCEPTOR

Ever increasing Waves of Landers, Fighters, Air mines and Smartbombs help the enemy capture the Earthlings on the planet surface. Your phaser and photon bombs will be a solid defense. In multi-colored surroundings you do battle to maintain control of your homebase!

**32K Tape \$19.95**

**32K Disk \$24.95**

All Game Names are Trademarks of Softlaw Corp.

ColorQuest is a Division of Softlaw Corp.

9072 Lyndale Ave. So., Minneapolis, MN 55420

For Software Support and Customer Service Call 612-881-2777

**AUTHORS' SUBMISSIONS ARE ENCOURAGED**



## Adventure Trilogy

3-D GRAPHIC ADVENTURE

Clash steel with thy foe in the arena of gore. Proved worthy, go in quest of the elusive Eye of Dazmor. If ye findest the orb, hast ye the might to ward off skem and the fortitude to restore the Eye? The ultimate high-res, 3-D quest for even the most experienced adventurer!

**16K Tape \$24.95 32K Disk \$29.95**



VEGAS GAMEPAK

Why fly to VEGAS when you can have a casino at home! The VEGAS GAMEPAK is five action packed games with great graphics & sound. SLOT MACHINE - BLACKJACK - UP AND DOWN THE RIVER - CRAPS & KENO.

**16K Tape \$19.95 16K Disk \$24.95**



## MS. NIBBLER

Ms. Nibbler is not just another pretty face with glossy red lips. She's a feisty lady, who moodily prowls her black maze. This game has the real arcade action and the real arcade look too! Your joystick will almost burn out as you try to keep up!

**16K Tape \$19.95 16K Disk \$24.95**



## THE NIBBLER

The King of Pac games is here. This fast-paced maze-chase game will challenge the most skilled. You guide The Nibbler through the maze, the portals, onward to the Energy Pills. Then the Ghouls, constantly at your heels, will end up in your belly! The better you get the better you have to become to master the blazing speed. You haven't pushed your skill until you've tried this one!

**16K Tape \$19.95 16K Disk \$24.95**



If your Dealer is out of stock ORDER DIRECT!



ORDERING

Make checks or money orders payable to Softlaw Corp. Personal checks allow 3 weeks. MAIL ORDERS: \$2.00 U.S. Shipping (\$4.00 CANADA \$10 OVERSEAS) NO C.O.D.'s Minn. residents add 6% sales tax.

Distributed in CANADA by Kelley Distributing

Rainbow Check  
Plus

1030.....032B	56	12994....1334	147
2026.....0658	134	20075....1654	132
2100.....0967	42	30120....1A37	61
4010.....0D46	161	30518....1E1B	178
5060.....104E	168	END.....2056	101

Listing 5

```

100 CLEAR:CLS(O):DIMB$(20),C$(20),C(20),D$(20),D(20),A1$(25),A2$(25),A3$(25),KA(12),AK(12),EK(69)
110 CLS(O):AH=15:AI=12:D(6)=5:D(7)=5:D(2)=5:LV=100:HV=10:VV=5:P=115
1000 IFMV=OTHER2000
1001 Q=P-LV:PRINT@9,A1$(Q)
1002 IFDJ=OTHERFORX=1TO69:READEK(X):NEXT:DJ=1
1005 IFP=115ANDDA=OTHERFORX=1TO20:IFC(X)=1THENC(X)=113
1006 IFP=115ANDDA=OTHERNEXTX
1010 IFP=115ANDDA=OTHERNH=0:PRINT@288,"THAT DWARF CAME OUT OF NOWHERE AND HIT ME OVER THE HEAD-WHEN I WOKE UP,I FOUND MYSELF IN THIS DUNGEON CELL.IN THE NORTH WALL IS A DOOR":DA=1:O=0:T=0:D(1)=3:C(16)=3:C(17)=3:GOTO15000
1020 IFP=115ANDDC=OTHERNO=0:T=0:D(1)=3:GOTO15000
1023 IFP=115ANDDU=1THENO=1:PRINT@288,"THERE IS WRITING ON THE WALL!":D(17)=3:GOTO15000
1025 IFP=115THENO=1:IFDK=OTHERPRINT@288,"IT'S NOW EMPTY!":DK=1:GOTO15000ELSEGOTO15000
1030 IFP=114ANDDC=OTHERGOSUB4000:O=0:O=5:DC=1:H=0:C(15)=6:C(16)=6:D(6)=6:C(17)=6:C(18)=6:D(1)=6:D(4)=6:D(5)=6:D(7)=6:D(8)=6:D(9)=6:D(14)=6:GOTO15000
1040 IFP=114THENO=5
1050 IFP=112ANDDN=OTHERIFAC=OTHERNO=9:AF=1:DN=1:GOTO30500
1060 IFP=112THENO=9:T=0
1070 IFP=107THENO=3:T=2:D(11)=3:IFDQ=OTHERPRINT@288,"IT DISSIPATED!":DQ=1:IFDP>OANDDM>OORDP>OANDDR>1THENPRINT@320,"I FEEL WEAKER"
1080 IFP=110THENPRINT@288,"TO THE WEST I SEE THE GREEN VALLEY OF BLENFORS":O=4:T=2:D(12)=3:D(11)=3
1090 IFP=105THENFORX=1TO1000:NEXT:CLS:PRINT@256,"KARRAK HAS BEEN SUCCESSFUL IN HIS QUEST":FORX=1TO5000:NEXT:END
1999 GOTO15000

```

```

2000 REM
2010 IFP=115ANDDC=OTHER2020ELSE2500
2020 IFB=1THEN2021ELSE2100
2021 IFC<>OORJ<>OTHER2022ELSE2100
2022 IFD(J)=3ORD(J)=P ORD(J)=5THEN2024
2023 IFC(C)=1ORC(C)=3ORC(C)=P THEN2024ELSE2100
2024 IFJ=1THENPRINT@288,"SOLID OAK,MASSIVE HINGES,BARS INSMALL OPENING IN DOOR.A SMALL TURTLE CARVED INTO THE CENTER":D(5)=3:D(4)=3:GOTO15000
2026 IFJ=4THENPRINT@288,"BRONZE,THICK AS MY WRIST":IFDB=0ANDDC=OTHERFORX=1TO1000:NEXT:PRINT@320,"FAR DOWN THE HALL IS A PILE OF OBJECTS-IT MAY BE MY STUFF":GOTO150:ELSEGOTO150
2028 IFJ=5ANDDF=OTHERPRINT@288,"BRONZE,PINS IN PLACE":D(9)=3:GOTO15000
2029 IFJ=5ANDDF=1THENPRINT@288,"BRONZE,PINS MISSING":GOTO150
2030 IFJ=8THENPRINT@288,"ABOUT SIX INCHES DEEP":GOTO150
2032 IFJ=6ANDDE=OTHERPRINT@288,"STRAW COVERED":D(8)=3:GOTO15000
2034 IFJ=6ANDDE=1ANDC(18)=OTHERPRINT@288,"A NAIL":C(18)=3:GOTO15000
2036 IFJ=9THENPRINT@288,"ONE INCH THICK,SIX INCHES LONG":GOTO150
2038 IFJ=7THENPRINT@288,"ONE SOLID PIECE OF STONE":GOTO150
2040 IFJ=2THENPRINT@288,"LARGE BLOCKS OF STONE":GOTO150
2050 IFC=17THENIFDG=OTHERPRINT@288,"BREAD ON IT":C(15)=3:GOTO15000:ELSEPRINT@288,"EMPTY":GOTO150
2052 IFC=16THENIFDH=OTHERPRINT@288,"WATER IN IT":D(14)=3:GOTO15000:ELSEPRINT@288,"EMPTY":GOTO150
2054 IFJ=14ANDDH=OTHERPRINT@288,"LOOKS+SMELLS OK":GOTO150
2056 IFC=15ANDDG=OTHERPRINT@288,"LOOKS+SMELLS OK":GOTO150
2058 IFC=18THENPRINT@288,"EIGHT INCHES LONG,ONE-HALF INCH THICK":GOTO15000
2100 IFB=14ANDC=15ANDC(15)=1THENC(15)=5:DG=1:PRINT@288,"UUUUUMMMM":AG=AG+5:H=H-1:GOTO15000
2110 IFB=15ANDJ=14ANDC(16)=1ANDDH=OTHERD(14)=5:DH=1:PRINT@288,"VERY REFRESHING":AG=AG+5:GOTO15000
2120 IFB=13ANDJ=9ANDDF=OTHERPRIN

```



Now With 8 Free  
Software Programs—Home  
Finance, Word Processing,  
Games, Worth \$150.00.  
Call For Details



This, quite literally, is the color computer America has been waiting for. One of the best sellers in the United Kingdom, the Dragon will soon be manufactured by TANO to serve American consumers who want a serious, affordable computer; one that has proven itself at providing educational and home management applications as well as fun and games. To meet this challenge, the Dragon was born. With a standard 64K of RAM. A professional typewriter-style keyboard guaranteed for 20 million key operations. And an impressive array of options which include disk controller and drive, a printer, audio cassette recorder, a modem (RS-232 serial I/O), joysticks, game cartridges and a free BASIC training manual.

# DRAGON! THE COLOR COMPUTER YOU'VE BEEN WAITING FOR.

And full editing features allow you to insert, delete or change at will. Oh yes — don't forget the colors! The Dragon features nine; with five different resolutions from 512 points of text (16x32) to 49,152 points (256x192) at high resolution. And you can view these amazing phenomena through either your composite video color monitor or VHF TV.

So goes the Dragon's story. If you'd like to know more, just mail the coupon or call George Merchant (our Director of Marketing) toll free at 1-800-327-7671.

Software developers and dealer inquiries are welcome. The Dragon is destined to become legend as America discovers its great performance is no myth.

Using the new 6809E Microprocessor (a great advance on the original 6502 still used by our competition), the Dragon brings advanced computer functions well within your reach. And priced below \$400, it's anything but expensive.

But these aren't the only points of difference with which our Dragon roars. Unlike most units, the Dragon gives Extended Microsoft™ \* Color BASIC as its standard language while the competition is still stuck in Microsoft™ \* BASIC training. The Dragon's advanced graphics features include set, line, draw, circle, paint, print (a and print using. Of course the Dragon also features advanced sound capabilities.

\*Microsoft™ is a registered trademark of Microsoft Corp.

Please send me more information on the Dragon.

NAME \_\_\_\_\_

COMPANY \_\_\_\_\_

ADDRESS \_\_\_\_\_

CITY \_\_\_\_\_ STATE \_\_\_\_\_

ZIP \_\_\_\_\_ PHONE \_\_\_\_\_

**TANO**  
MICROCOMPUTER  
PRODUCTS CORP.

4301 Poche Court West  
New Orleans, LA 70129

```

T@288,"WITH WHAT":INPUTDF$:IFDF$
=C$(18)ANDC(18)=1THENDF=1:D(9)=5
:PRINT@288,"I GOT THE PINS OUT-T
HEY DISAP- PEARED IN THE STRAW"
:GOTO15000
2140 IFB=16ANDJ=8ANDDE=0THENPRIN
T@288,"'CLINK'":DE=1:GOTO150
2150 IFB=16ANDJ=8THENPRINT@288,"
NOTHING":GOTO150
2160 IFB=17ANDJ=10RB=13ANDJ=1THE
NPRINT@288,"DOESN'T BUDGE":GOTO1
50
2170 IFB=17ANDJ=40RB=13ANDJ=4THE
NPRINT@288,"SOLID":GOTO150
2180 IFB=17ANDJ=90RB=17ANDJ=50RB
=13ANDJ=90RB=13ANDJ=5THENPRINT@2
88,"NOTHING":GOTO150
2500 IFB=1ANDJ=10ANDAF=1THENPRIN
T@256,DM$:" RIGHT NOW":DP=DM:DR=
DR+1:GOTO150
2510 IFB=1ANDJ=17ANDDU=1ANDP=115
THENIFD(17)=3ORD(17)=P THENPRINT
@288,"INVOKE 'D$(16)'" BEFORE C
ASTING YOUR LAST HOPE INTO THE
WATERS":GOTO150
2999 GOTO12990
3000 IFMV=0THEN4000
3001 Q=P-LV:PRINT@9,A2$(Q)
3010 IFP=207THENT=3:O=0:D(11)=3:
D(1)=3:PRINT@288,"THE STAIRWAY T
URNS HERE.A SMALL DOOR IS SET IN
TO THE SOUTH WALL"
3020 IFP=210THENT=3:O=0:D(11)=3
3999 GOTO15000
4000 REM
4010 IFB=1ANDJ=1THENPRINT@288,"E
IGHT INCHES SQUARE,A PULL KNOB O
N THE RIGHT SIDE.ON THE DOOR ISA
BROWN STAIN-IT LOOKS LIKE D
RIED BLOOD":D(13)=3:GOTO15000
4020 IFB=1ANDJ=13ANDDU=0THENPRIN
T@288,"A SMALL PIN WITH A GREEN
STAIN ON THE END IS STICKING OU
T. I CAREFULLY REMOVED IT":DU=
1:GOTO150
4030 IFB=1ANDC=19ANDC(19)=1THENP
RINT@288,"YELLOW LIQUID INSIDE":
GOTO150
4040 IFDT=0THENIFB=80RB=17THENIF
J=10RJ=13THENIFDU=0THENPRINT@288
,"SOMETHING PRICKED MY FINGER":F
ORX=1TO3000:NEXT:CLS:PRINT@265,N
$:END:ELSEPRINT@288,"THERE IS A
VIAL OF CLEAR LIQUID INSIDE":C(1
9)=3:DT=1:GOTO15000
4050 IFB=15ANDC=19ANDC(19)=1THEN
C(19)=5:PRINT@288,"THE 'C$(19)'"
DISAPPEARED!":H=H-1:AG=AG/2:PRIN
T@320,"MY THROAT IS BURNING!":IF
AG<.5THENFORX=1TO3000:NEXT:CLS:P

```

```

RINT@263,N$:END:ELSEGOTO15000
4999 GOTO12990
5000 IFMV=0THEN6000
5001 Q=P-LV:PRINT@9,A3$(Q)
5010 IFP=3040RP=314THENIFAB=0THE
NAE=1:O=5:T=0:GOTO30000
5020 IFP=304THENO=5
5030 IFP=314THENO=5
5040 IFP=307THENO=2:T=1:D(11)=3
5050 IFP=303THENO=8:D(3)=3
5060 IFP=308THENO=13:T=0:D(3)=3:
PRINT@288,"TO THE SOUTH IS A LAR
GE POOL,ON BOTH SIDES IS ENOUGH
ROOM TO GO AROUND"
5070 IFP=313THENO=9:D(3)=3
5080 IFP=305THENO=6:T=0:D(3)=3
5090 IFP=315THENO=7:T=0:D(3)=3
5100 IFP=310THENO=10:T=1:D(11)=3
5999 GOTO15000
6000 REM
6010 IFP<>307THEN6020ELSE12900
6020 IFB=18ANDJ=16ANDDW=0THENDW=
1:PRINT@288,"THE WORD ECHOED OFF
THE CAVERN WALLS-THE VERY GROU
ND SHOOK":GOTO150
6030 IFB=9ANDC=19ANDC(19)=1ANDDW
=1THENPRINT@288,"WHERE":INPUTXM$
:IFXM$=D$(3)THENFORX=1TO1200:NEX
T:PRINT@288,"THE WATER IS BOILIN
G,YELLOW FUMES ARE RISING FR
OM IT":H=H-1:C(19)=5:AB=1:GOTO15
000
6040 IFB=9ANDC=19ANDC(19)=1THENP
RINT@288,"WHERE":INPUTXM$:IFXM$=
D$(3)THENPRINT@384,"'SPLASH'":H=
H-1:C(19)=5:GOTO15000
12990 IFB=20RB=11THENPRINT@256,"
NO EFFECT":PRINT@288,"":GOTO150
12991 IFB=8ANDC=6THENPRINT@288,"
IT'S ALREADY OPEN":GOTO150
12992 IFB=1ANDC=8ANDC(8)=1THENPR
INT@288,"CROSS-SHAPED":GOTO150
12993 IFB=1ANDC=6ANDC(6)=1THENPR
INT@288,"SMALL,LEATHER":GOTO150
12994 IFB=1ANDC=1ANDC(1)=1THENPR
INT@288,"SOLID BRONZE,3 FEET LON
G":GOTO150
12995 IFB=1ANDC=4ANDC(4)=1THENPR
INT@288,"NINE INCHES LONG,DOUBLE
SIDED BLADE":GOTO150
12997 IFB=1THENPRINT@288,"I DON'
T SEE ANYTHING SPECIAL":GOTO150
12998 PRINT@448,"I'M UNABLE TO D
O THAT NOW":GOTO150
12999 GOTO12990
20000 DATA LOOK,HIT,PUT,GET,LIST
,DROP,VIEW,OPEN,THROW,UNLOCK,STA
B,CLOSE,PUSH,EAT,DRINK,MOVE,PULL
,SAY,JUMP,CRAWL
20020 DATA SWORD,FLINT,ROPE,DAGG

```

ER, IDOL, POUCH, CHALICE, KEY, SACK, T ORCH, PENDANT, MACE, HAND AX, SCROLL , BREAD, CUP, PLATE, NAIL, VIAL, COIN

20040 DATA DOOR, WALL, POOL, BARS, H INGES, FLOOR, CEILING, STRAW, PINS, C LOUD, STAIRS, VALLEY, KNOB, WATER, TU RTLE, ELTRUT, WRITING, FUMES, PRYBAR , HAMMER

20049 REM A2\$( )  
20050 DATA 201, 202, 203, 204, 205, 2 06, LANDING, 208, 209, STAIRWAY

20055 DATA 211, 212, 213, 214, 215, 2 16, 217, 218, 219, 220

20060 DATA 221, 222, 223, 224, 225  
20069 REM A1\$( )

20070 DATA 101, 102, 103, 104, OUTSI DE, 106, STAIRWAY, 108, 109, EXIT

20075 DATA 111, HALL, HALL, HALL, CE LL, 116, 117, 118, 119, 120

20080 DATA 121, 122, 123, 124, 125  
20089 REM A3\$( )

20090 DATA 301, 302, CAVERN, CAVERN , CAVERN, 306, STAIRWAY, CAVERN, 309, STAIRWAY

20095 DATA 311, 312, CAVERN, CAVERN , CAVERN, 316, 317, 318, 319, 320

20100 DATA 321, 322, 323, 324, 325  
20120 DATA 1514, 11, 1515, 1, 1516, 1 8, 1517, 18, 1518, 1, 1519, 11, 1520, 45

, 1521, 16, 1522, 1, 1523, 18, 1524, 20, 1525, 52

20140 DATA 73, 84, 96, 77, 85, 83, 84, 96, 72, 65, 86, 69, 96, 66, 69, 69, 78, 96 , 65, 96, 77, 65, 71, 73, 67, 65, 76, 96, 9 6, 96, 96, 96, 83, 80, 69, 76, 76, 109, 73 , 96, 87, 65, 76, 75, 69, 68, 96, 82, 73, 7 1, 72, 84, 96, 84, 72, 82, 79, 85, 71, 72, 96, 84, 72, 69, 68, 79, 79, 82, 97

30000 REM  
30105 AJ=0

30107 IFAG<10THENAG=14  
30110 D(15)=3:0=16:T=0:PRINT@384

, "AN ENORMOUS TURTLE IS ATTACKIN G":AE=1

30111 IFDV=0THENPRINT@288, "IT CA ME OUT OF THE POOL":DV=1

30112 IFB=2ANDH\$=C\$(12)THENH\$=C\$ (1)

30113 IFB=11ANDH\$=C\$(13)THENH\$=C \$ (4)

30115 AG=INT(AG):PRINT@288, "OPPO NENT'S STRENGTH=":PRINT@320, " KA RRACK'S STRENGTH=":PRINT@308, AI:

PRINT@340, AG

30120 IFB=2ANDH\$=C\$(1)THENX=RND( 4):IFX=1THENPRINT@256, "THE SHELL

IS TOO HARD-IT BIT ME":AG=AG-3: ELSEIFX=2THENPRINT@256, "A SMALL



## SOUTHERN SOFTWARE SYSTEMS

SERIOUS SOFTWARE FOR THE COLOR COMPUTER

Presenting... THE GRAPH ZAPPER,

THE BAR ZAPPER and THE PIE ZAPPER



- THE PIE ZAPPER draws pie charts of your data - plain or fancy sectors - 5 kinds of sectors - alternate sectors styles to make an outstanding impact - labeled sectors - option to display raw numbers or percentages on chart with or without totals.
- THE BAR ZAPPER creates bar graphs with multiple bars - five different bar styles - positive and negative bars - can use names or numbers for bar identification - plenty of options - "Extremely easy to use. . . Beautiful. . . Well prepared and documented tool." The Rainbow, April 1983.
- THE GRAPH ZAPPER plots line graphs of data and equations - multiple lines with different symbols - mix equations and data on the same graph - with or without grids - plots lines or points - "The Graph Zapper is one of the most completely documented pieces of software we have seen. . . The Graph Zapper is an outstanding utility and can be a major tool in statistical, business and other uses where graphic representation of numbers is desirable." The Rainbow, Dec. 1982
- Endless applications - electric consumption, stock prices, math class equations, children's height and weight, data analysis, trend indication, experimental results, statistical analysis, sales presentations.
- The three ZAPPERS provide you with a sophisticated capability that will handle from the simplest to the most complex graphing needs

### All three ZAPPERS have these Features:

- High resolution graphs with on screen numbers, titles, and labels.
- Sophisticated data editor makes changing data simple
- Disk version has added features including storing completed graphs on disk and menu driven file loading.
- Detailed user's guides for all features.
- Low resolution graphs can't compare.
- 14 day money back guarantee.
- User friendly, easy to understand
- Thorough error prevention.
- Save data for later graphing or editing.
- Low cost upgrade from tape to disk.
- Hard copies possible with readily available screen print programs for nearly any brand of printer
- Requires Ext. Color Basic and delivered on cassette

**\$15.95**

for 16K tape versions

add \$1.00 for shipping . . . send check, money order,  
or VISA/MasterCard number and expiration date

**\$19.95**

for 32K disk versions

\$44.95 for all three tape versions + \$3.00 shipping

\$56.95 for all three disk versions + \$3.00 shipping

Florida residents add 5% sales tax

## SOUTHERN SOFTWARE SYSTEMS

485 South Tropical Trail, Suite 109 • Merritt Island, Florida 32952 • (305) 452-2217



### MINER BY LARRY LANDWEHR

Like his father before him, Sid is a coal miner. Working hundreds of feet below ground it is Sid's job to blast the rock so that the coal seam is exposed. See if you can direct Sid to the most productive areas. How many lumps of coal can you collect before you run out of dynamite? Young and old alike will enjoy this hi-res all machine language game from the author of "IN ASSEMBLY LANGUAGE".

CAT# DMD18 16k \$14.95 (CAN) \$12.95 (US)

\*\*\*\*\*

### EXECCART BY PETER KARWOWSKI

EXECCART is a M/L program that allows you to copy ROMPAC programs to tape. They can then be loaded back into a 64K CoCo and examined or modified. You can run most of your ROMPAC's from disk without ever having to remove the disk controller. This saves tremendous wear and tear on the contacts. EXECCART may also be used to add a loader to your own programs to turn on 64K and to copy your BASIC ROMs into RAM so that you can make modifications.

CAT# DMD09 64K \$17.95 (CAN) \$14.95 (US)

\*\*\*\*\*

### THE SPOOLER BY PETER KARWOWSKI

Whenever you use your printer, your computer is totally dedicated to feeding it. This isn't such a problem when you just want to print out a couple of lines, but LLISTING a long program can be very boring. If you have better things to do than sit around waiting for the printer, then "THE SPOOLER" is just what you need. THE SPOOLER will work on ANY TRS-80 Color Computer from a 16K right up to 64K with disks. Extended BASIC is NOT required.

CAT# DMD10 16K \$12.95 (CAN) \$10.95 (US)

# THE DATAMAN

### NEWERROR BY PETER KARWOWSKI

NEWERROR will provide four extra functions and abilities for your Color Computer.

1. Give you an audible error warning.
  2. Provide full english error messages.
  3. Add the ON ERROR GOTO command to BASIC
  4. Allow simulated errors for debugging.
- As an added bonus we include a second M/L program that you can add to your own BASIC programs to provide them with the ON ERROR GOTO feature. You may use this program even in programs you sell.

CAT# DMD08 16K \$19.95 (CAN) \$16.95 (US)

### SCREEN BY JOHN MIRAK

Four much needed features are added to Basic with this new machine language utility program from Australia.

1. Automatic line numbering
2. Line by line program listing
3. Motor on/off from the keyboard.
4. Your choice of light or dark, orange, green or black screen with light or dark orange or green characters.

Works with Basic, Ext Basic & Disk Basic

CAT# DMD15 16K \$12.95 (CAN) \$10.95 (US)

**ADD 3% SHIPPING & HANDLING  
PER ORDER-MINIMUM \$2.50**

420 FERGUSON AVE. N.  
HAMILTON, ONTARIO  
CANADA L8L 4Y9  
PHONE 416-529-1319

**DEALER  
INQUIRES  
WELCOME**

**SWISS ARMY KNIFE BY RALPH BLOCH**

One of our most prolific authors (PRETTY PRINTER-P.U.F.F.-LIBRARY) has come up with another winner. As the namesake of this program has many blades so SAK has many functions. The disk owner will find it indispensable for diagnosing and fixing the many gremlins that attack a disk system. It will work on any number of tracks and can even read FLEX disks. By copying one sector at a time you can often save an otherwise uncopyable disk.

CAT# DM553 32K \$29.95 (CAN) \$25.50 (US)

**SUPER EDIT BY LARRY LANDWEHR**

This powerful new utility program from the author of "IN ASSEMBLY LANGUAGE" adds many new editing commands to Basic. You can PRINT one screenful at a time, DELETE a line or lines, JOIN several lines together and hide your programs, or FIND strings and variables. Also included are commands to INSERT, COPY, MOVE & REPLACE one line or a block of lines. Super edit works with Extended Basic but Extended Basic is not required.

CAT# DM016 16k \$19.95 (CAN) \$16.95 (US)

**SEND \$3 FOR OUR NEW  
80+ PAGE CATALOGUE**

**BONES BY MARK MORAN**

This original dice game is fun for the whole family. Play by yourself, against the computer or with your friends. Although simple enough for the youngest player the adults will find it addictive.

CAT# DM011 16K \$12.95 (CAN) \$10.95 (US)

Now you can 'Roll Them Bones' on the MC10. We have transferred this popular game without losing any of it's features.

CAT# DM101 4K \$12.95 (CAN) \$10.95 (US)

\*\*\*\*\*

**MUSIC EDITOR BY PATRICIA SHELTON**

This program will take regular sheet music and convert it to "play by number" music. You enter the words, notes and chords from the keyboard and the program will output, to the screen or printer, an easy to read version for C or G type organs. Your files can be edited and saved to disk or tape. Easily produce a songbook of your own favorite tunes.

CAT# DM012 16K \$12.95 (CAN) \$10.95 (US)

\*\*\*\*\*

**HOME INVENTORY BY JEFF PYNE**

Home Inventory was written for the average home owner to simplify the tedious task of weeding through his possessions. This small database will save an organised list of brand names, serial numbers, values, dates of purchase etc. This could prove to be your most valuable program if you ever have to deal with an insurance company so be sure you have a copy of the programs output in a safe place in case of fire or theft. Ext Basic required-Printer optional

CAT# DM013 16K \$12.95 (CAN) \$10.95 (US)

```

PIECE OF SHELL BROKE OFF":AH=AH-
1:ELSEIFX=3THENPRINT@256,"I MISS
ED-IT DIDN'T":AG=AG-3:ELSEPRINT@
256,"WE BOTH MISSED"
30125 IFB=11ANDH$=C$(4)THENX=RND
(4):IFX=1THENPRINT@256,"NO DAMAG
E AT ALL TO IT":ELSEIFX=2THENPRI
NT@256,"I NICKED IT'S FOOT":AH=A
H-1:ELSEIFX=3THENPRINT@256,"IT S
LASHED MY SIDE":AG=AG-2:ELSEPRIN
T@256,"IT BIT MY LEG":AG=AG-3
30126 IFB=11ANDH$=C$(4)ORB=2ANDH
$=C$(1)THEN30130
30127 PRINT@256,"IT BIT A CHUNK
FROM MY ARM":AG=AG-2:GOTO30200
30130 X=RND(100):IFX>96THENPRINT
@416,"I TRIPPED,IT TORE OPEN MY
CHEST KARRAK IS DEAD":PRINT@340,
"0":FORX=1TO5000:NEXT:CLS:END
30200 PRINT@308,AH:PRINT@340,AG
30250 IFAG<1ANDAH<1THENPRINT@416
,"BOTH THE TURTLE AND KARRAK ARE
DEAD":FORX=1TO2500:NEXT:CLS:EN
D
30300 IFAH<1THENPRINT@256,"THE T
URTLE IS DEAD":PRINT@384," ":O=A
J:BF=1:AE=0:D(15)=3:AB=1:FORX=1T
O2000:NEXT:GOTO15000
30400 IFAG<1THENPRINT@256,N$:FOR
X=1TO2000:NEXT:CLS:END

```

```

30499 GOTO15000
30500 REM
30505 IFAC=1THEN15000
30507 AJ=0
30510 PRINT@384,"A GASEOUS CLOUD
IS BLOCKING MY ADVANCE TO THE
WEST":D(10)=3:AF=1
30515 AG=INT(AG):PRINT@288,"OPPO
NENT'S STRENGTH=":PRINT@320," KA
RRAK'S STRENGTH=":PRINT@308,"?":
PRINT@340,AG
30518 DM$="":DM=RND(9)-1:IFDM=0T
HENDM$="BLACK"ELSEIFDM=1THENDM$=
"GREEN"ELSEIFDM=2THENDM$="YELLOW
"ELSEIFDM=3THENDM$="BLUE"ELSEIFD
M=4THENDM$="RED"ELSEIFDM=5THENDM
$="BUFF"ELSEIFDM=6THENDM$="CYAN"
ELSEIFDM=7THENDM$="MAGENTA"ELSED
M$="ORANGE"
30519 IFDS=0THENDP=DM:IFDM<5THEN
30518ELSEDS=1
30520 IFC(1)=1ANDB=2ORC(12)=1AND
B=2THENPRINT@448,"WENT RIGHT THR
OUGH-NO DAMAGE":AG=AG-DM:IFDM>0T
HENPRINT@256,"I FEEL WEAKER"
30525 IFC(4)=1ANDB=11ORC(13)=1AN
DB=11THENPRINT@448,"NOTHING ACCO
MPISHED":AG=AG-(DM*1.5):IFDM>0T
HENPRINT@256,"I FEEL WEAKER"
30540 IFB<>2ANDB<>11THENIFA$="S"
THENVV=3:DN=0:O=5:AF=0:D(10)=112
:PRINT@288,"":PRINT@320,"":PRINT
@352,"":PRINT@384,"":PRINT@416,"
":PRINT@448,"":GOTO15000ELSEIFA$
="W"THEN30600ELSE246
30541 PRINT@308,"?":PRINT@340,AG
30560 IFAG<1THENFORX=1TO2000:NEX
T:CLS:PRINT@264,N$:END
30570 GOTO150
30600 AG=AG-DP:IFAG<1THEN30560
30610 AF=0:AC=1:D(10)=5:HV=5:VV=
2:LV=100:P=107:A$="&":GOTO143
30999 GOTO15000
40000 DC=1:FORX=1TO69:POKEX+1311
,EK(X):NEXT:RETURN

```

## STOCK & FUND INVESTING

with the  
**TRS-80\* COLOR COMPUTER**  
 USE FUNDGRAF AND FUNDFILE

FUNDGRAF is a stock market analysis program that not only graphs and analyzes funds or stocks, but also makes decisions on when to BUY and SELL. Improve market timing using your COC.

GRAPHS fund's progress (up to 200 weeks). SUPERIMPOSES for comparison: a line of constant percent growth or a graph of any other fund (or stock). CALCULATES over any time span: the percent price change and the moving average (any span). INDICATES BUY and SELL signals. FUNDGRAF requires 16 K ECB min.

16/32 K Tape ..... \$49.95  
 16/32 K 5 in. Disk ..... \$69.95  
 ADD \$2 handling on all orders.

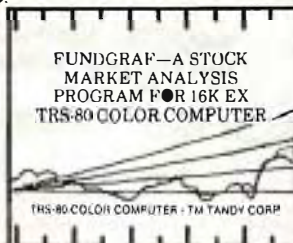

FUNDFILE is a portfolio and account management program for securities. Manage single or multiple portfolios of stocks, mutual funds, bonds, money market funds, etc. FUNDFILE allows easy maintenance of all your records for accurate portfolio evaluation. NEW 32K VERSION of FUNDFILE summarizes all transactions (dividends, interest, purchases and sales) between any two dates of your choice: weekly, yearly, etc. Categorizes interest and dividends paid as to tax liability (tax free, etc.) and capital gains as long or short term. Great for tax reports.

FUNDFILE REQUIRES 16 K ECB min. and 80-COL PRINTER.  
 5-in. Diskette only for 16 K ECB ..... \$27.95  
 5-in. Diskette only for 32 K ECB ..... \$37.95  
 ADD \$2 handling on all orders.



Write for free brochure for details. Dealer inquiries invited.

**PARSONS SOFTWARE, DEPT. G**  
**118 WOODSHIRE DRIVE**  
**PARKERSBURG, WV 26101**

### Listing 6

```

200 FORB=1TO20:WW$=B$(B):WW=INST
R(1,A$,WW$):IFWW>0THENVW=LEN(B$(
B)):GOTO205ELSENEXT:B=0:PRINT@25
6,"I CAN'T DO THAT":GOTO150
205 FORY=1TOVW:MID$(A$,WW,1)=" "
:WW=WW+1:NEXTY
220 FORC=1TO20:WW$=C$(C):WW=INST
R(1,A$,WW$):IFWW>0THENGOTO245ELS
ENEXT:C=0:GOTO235
235 FORJ=1TO20:WW$=D$(J):WW=INST
R(1,A$,WW$):IFWW>0THEN245ELSENE
XT:J=0

```

# PRICE BREAKTHROUGH

## Super Sale on New Disk Drives

Starting at \$169.00!

**Tandon — Siemens — Remex — MPI — Teac — Shugart — Tabor**

40 or 80 Tracks — Single or Dual Head — New 3½" Drivette™

Our Disk Drives Are Capable Of Single And Dual Density Operation

The NEWEST Technology Capable Of Operating On Most Popular Computers

Drive a Hard Bargain!!™ — 5 M.B.-20 M.B. Complete Systems . . . . . from \$999.95

Diskette Breakthrough — 10 Pack in Library Case — ~~\$18.95~~ <sup>NEW LOW PRICE</sup>

Since We Are Always Finding Ways To Save You Money,  
Please CALL For Our Most Current Pricing.

### TOLL FREE ORDERING

**1-800-343-8841**

### GENERAL AND TECHNICAL

**1-617-872-9090**

- |   |                          |                   |
|---|--------------------------|-------------------|
| Model I/III/IV Drives (0 1 2 3) . . . . .                           | starting at \$169.00     |                   |
| Color Computer Drive (0 1 2 3) . . . . .                            | \$ Call Toll Free        |                   |
| Apple/Franklin Compatible Add-On Drives with Case & Cable . . . . . | Now 40 Tracks { \$219.95 | NEW LOW PRICE     |
| Apple/Franklin Compatible Drives with Controller . . . . .          |                          |                   |
| Model I/III/IV Memory Upgrade . . . . .                             |                          | Call Toll Free    |
| Printers — Daisywheel/Dot Matrix . . . . .                          |                          | \$ Call Toll Free |
| Diskettes in Library Cases . . . . .                                | \$18.95                  | New Low Price     |
| Cases and Power Supplies — (Single-Dual-1/2 Height) . . . . .       | starting at \$44.95      |                   |
| Printer Buffers 8K to 512K . . . . .                                | starting at \$143.95     |                   |
| Percom Double Density Controller (Model I) . . . . .                |                          | \$ Call Toll Free |
| Holmes Model I/III Speed-up Mod-VID/80 . . . . .                    | starting at \$90.00      |                   |
| Color Computer Printer Interfaces . . . . .                         | starting at \$29.95      |                   |
| Cables — Printer/Disk Drive . . . . .                               | starting at \$23.00      |                   |
| DOSPLUS . . . . .   |                          | \$ Special Prices |
| Repair Services Now Offered — FAST Turn-a-Round . . . . .           |                          | \$ Call Toll Free |

Warranty on Disk Drives — 6 Months — Extended Warranty \$ Call Toll Free

## SOFTWARE SUPPORT, INC.

One Edgell Road, Framingham, MA 01701 (617) 872-9090

Hours: Mon. thru Fri. 9:30 am to 5:30 (E.S.T.) Sat. 10 am to 4:30 pm

### DEALER INQUIRIES INVITED.

TERMS:  
M.C./Visa/Amex and personal checks accepted at no extra charge.  
C.O.D., please add \$3.00.  
Shipping: Please call for amount.  
Not responsible for typographical errors.

© Copyright 1983

<p><b>CANADA</b>  <b>MICRO R.G.S. INC.</b>                  751, CARRE VICTORIA, SUITE 403                  MONTREAL, QUEBEC, CANADA, H2Y 2J3                  Regular Tel. (514) 845-1534                  Canadian Toll Free 800-361-5155</p>
---

**Service! Service!**

*All in stock products are shipped within 24 hours of order. Repair/Warranty service is performed within 24 hours of receipt unless otherwise noted. We accept C.O.D., foreign and APO orders. Schools and D&B corporate P.O.s accepted.*

# A Winter Wonderland

Program by Andrew L. Shemo

It's that time of year again when you can bundle up and go out in the crisp winter air to make a snowman or sit by the cozy fire and dream about someone else making that snowman — like your CoCo.

Here's a short 16K ECB program sent to us by Andrew L. Shemo of Canton, Ohio that makes your winter wonderland come true. *Winter* is a Hi-Res graphic presentation of a chilly, familiar scene with falling snow, trees and a snowman. If your computer will not accept the high-speed poke (POKE 65495,0), delete lines 460 and 510.

So, build a fire, make some cocoa and let your CoCo draw a winter wonderland.

Rainbow  
Check  
Plus

220	..... 0276	110
480	..... 04D1	42
1020	..... 0697	15
END	.... 08CA	74

```

1 '*****
2 '**** W I N T E R ****
3 '**** BY ****
4 '** ANDREW L. SHEMA **
5 '**** OCT. 1983 ****
6 '*****
10 CLS0:PRINT@233,"press"+CHR$(1
28)+"any"+CHR$(128)+"key";
20 IF INKEY$="" THEN 20
30 POKE 65494,0
40 PMODE 2,1:PCLS:SCREEN 1,1:CLS
50 GOSUB 1000
60 '*** GROUND ***
    
```

(Andrew L. Shemo, an 18-year-old high school graduate, has recently joined the Air Force to enter into electronics and computers. He is a self-taught CoCo enthusiast and this is his first Hi-Res graphics program.)

```

70 CIRCLE(128,185),135,1,.1,.5,1
80 PAINT(128,191),1,1
90 CIRCLE(0,191),105,1,.4
100 PAINT(5,155),1,1
110 '*** BOTTOM ***
120 CIRCLE(125,160),35,1
130 PAINT(115,172),1,1
140 '*** MIDDLE ***
150 CIRCLE(125,120),23,1
160 PAINT(110,130),1,1
170 '*** HEAD ***
180 CIRCLE(125,92),15,1
190 PAINT(114,96),1,1
200 FORTI=1 TO 500:NEXT
210 '*** EYES ***
220 PRESET(121,88):PRESET(121,89)
230 PRESET(128,88):PRESET(128,89)
240 '*** NOSE ***
250 LINE(125,90)-(127,93),PRESET
:LINE -(123,93),PRESET:LINE -(12
5,90),PRESET
260 '*** MOUTH ***
270 CIRCLE(125,95),9,0,.4,0,.5
280 '*** BUTTONS ***
290 FOR Y=105 TO 130 STEP 6
300 PRESET(125,Y):PRESET(125,Y+1)
310 NEXT Y
320 '*** RIGHT TREE ***
330 LINE(245,191)-(245,150),PSET
340 LINE(256,150)-(190,150),PSET
350 LINE -(256,20),PSET
360 PAINT(195,149),1,1
370 '*** LEFT TREE ***
380 LINE(20,150)-(20,140),PSET
390 LINE(29,155)-(29,140),PSET
400 LINE(0,140)-(50,140),PSET
410 LINE -(25,50),PSET
420 LINE -(0,140),PSET
    
```



```

430 PAINT (25,55),1,1
440 '*** BORDER ***
450 FOR Y=0 TO 191:PRESET(256,Y)
: NEXT Y
460 POKE 65495,0
470 FOR X=256 TO 0 STEP-1:PRESET
(X,191):PRESET(X,190):NEXT X
480 POKE 65494,0
490 FOR Y=191 TO 0 STEP-1:PRESET
(0,Y):NEXT
500 '*** SNOW ROUTINE ***
510 POKE 65495,0
520 T=1:S=4:DIM X(255)
530 FOR Y=1 TO T STEP S
540 IF X(Y)=0 THEN 570
550 IF PPOINT(X(Y),Y+1)=5 THEN
GOTO 570
560 PRESET(X(Y),Y):PSET(X(Y),Y+S
,1)
570 NEXT Y
580 T=T+S:IF T>180 THEN T=180
590 FOR C=Y-S TO 1 STEP- S:X(C+S
)=X(C):NEXT C
600 X(1)=RND(250)+2:IF X(1)=125 T
HEN 600 ELSE 530
1000 '*** GRAPHICS STRINGS ***
1010 A$(1)="M+10,+30;R5;M+6,-8;M
+6,+8;R5;M+10,-30;L6;M-7,+22;M-6
,-8;L3;M-6,+8;M-7,-22;L6;BM+45,+

```

```

30" 'w
1020 H(1)=32:V(1)=12
1030 A$(2)="U6R6U18L6U6R18D6L6D1
BR6D6NL18;BR6" 'i
1040 H(2)=80:V(2)=12
1050 A$(3)="U3OR10;M+10,+25;U25R
6D30L10;M-10,-25;D25L6;BR30" 'n
1060 H(3)=105:V(3)=38
1070 A$(4)="BR12U24L12U6R30D6L12
D24L6;BR25" 't
1080 H(4)=140:V(4)=12
1090 A$(5)="U3OR20D6L15D6R10D6L1
0D6R15D6NL20;BR6" 'e
1100 H(5)=175:V(5)=38
1110 A$(6)="U3OR15F5D5G5L2M+8,+1
4;D1L5U1;M-8,-12;L3D13L5;BM+5,-2
5;R6F2D3G2L6U6" 'r
1120 H(6)=200:V(6)=12
2000 '*** DRAW "WINTER" ***
2010 DRAW"BM 30,10;"
2020 FOR R=1 TO 6
2030 DRAW A$(R)
2040 NEXT R
2050 FORTI=1 TO 50:NEXTTI
2060 FOR R=1 TO 6
2070 PAINT(H(R),V(R)),1,1
2080 NEXTR:FORTI=1 TO 800:NEXTTI
2090 RETURN

```

# WORD PROCESSOR for your Color Computer

only  
**\$14.95**

Yes! That's right, because we want to create some excitement with an offer you can't pass up — a professional quality full screen oriented word processor that would be a bargain at \$50. It's a good one too. Take a look at what you get.

MASTER WRITER's **FULLSCREEN-ORIENTED EDITOR** allows you to move the cursor anywhere in your text using the up, down, right and left arrows. Do this one character at a time or by line or page. Insert, delete or replace text at the cursor watching your changes as you make them. Delete or move blocks of text from one place to another. Merge in text from other files.

**AUTOMATIC CARRIAGE RETURN** after last complete word on each line, with this and **AUTOMATIC PAGE FEED** you don't have to worry about where a line or page ends — just type!

MASTER WRITER runs on a **16K, 32K, or 64K COLOR COMPUTER**, taking advantage of all available memory. Use it with **DISK OR CASSETTE** based systems. **EXTENDED BASIC IS NOT REQUIRED.**

**EASY TO UNDERSTAND MANUAL** has you comfortably using MASTER WRITER in minutes. It is a **USER-FRIENDLY MENU-DRIVEN SYSTEM** with single letter commands. Check any command without having to refer to the manual with the **HELP SCREEN.**

**10 PROGRAMMABLE FUNCTION KEYS** allow easy insertion of frequently used words or phrases.

**WORKS WITH ANY PRINTER.** Take full advantage of your printer's special functions such as variable character size and emphasized characters with **EASY EMBEDDING OF PRINTER CONTROL CODES.**

**GLOBAL SEARCH** function lets you quickly locate specific strings for replacement or deletion.

Customize form letters or standard text with MASTER WRITER'S **EMBEDDED PAUSE** feature. Just "fill in the blanks" when your printer pauses for a personalized appearance.

**LIMITED MULTI-TASKING** feature lets you print one file while editing another.

In addition to regular text you can use MASTER WRITER to **CREATE BASIC PROGRAMS** with the convenience of full-screen editing.

**OTHER FEATURES** include easy setting of left, right, top and bottom margin, printer line width, and lines per page. Also auto repeat keys, auto line centering, auto page numbering and choice of display color formats.

And, perhaps one of the best features, is MASTER WRITER'S **SUPER LOW PRICE OF \$14.95.** At this price you can't go wrong. Buy it today!

**TO ORDER** send \$14.95 for cassette version or \$19.95 for disk version plus \$2.50 shipping (Calif. residents add 6% sales tax) to: **PYRAMID DISTRIBUTORS, 527 HILL ST., SANTA MONICA, CA 90405 (213) 399-2222.**

# MASTER WRITER

**\$14.95 Cassette**  
**\$19.95 Disk**

# FUN AND GAMES



## TIME PATROL

Travel thru different time zones, fending off attacking blimps, helicopters & space crafts from each time period. Become intimate with the full 360 degree firing range of your joystick! (Requires 32K)

(32K Cass) \$24.95

(32K Disk) \$27.95



## STORM

A "tempest" of a game, it has 135 levels of play, fast action, graphics & sound. (Requires 16K)

(16K Cass) \$21.95

(16K Disk) \$24.95



## COLOR PAC ATTACK II

Three little muggers chase your man relentlessly around a maddening maze as you furiously try to build up points. Perfect replica of your favorite arcade! (Requires 16K)

(16K Cass) \$24.95

(16K Disk) \$27.95



## NERBLE FORCE

Not just another DEFENDERS. Brilliant graphics show wide angle & close-up views of the city you protect. Use forward & reverse thrusters, long range phasers, & quick maneuvers. Requires only one joystick! (Requires 16K)

(16K Cass) \$21.95

(16K Disk) \$24.95



## SHARK TREASURE

Ever been eye-to-eye (or jaw-to-jaw) with a shark? Experience the "excitement" of dodging around the dreaded beasts as a scuba diver after treasure near a sunken galleon. Even if you don't amass wealth you'll enjoy the fine graphics! (Requires 16K)

(16K Cass) \$24.95

(16K Disk) \$27.95

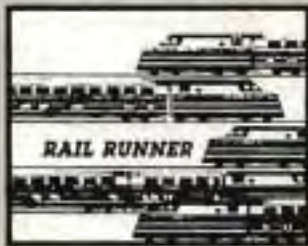

## RAIL RUNNER

Hurry! Watch Out!! Oh No!! Whew! Your railroad engineer must scurry over the track of the busiest train switchyard ever, dodging speeding trains & hand-cars, to rescue the poor little hobo on the wrong side of the track! (Requires 16K)

(16K Cass) \$21.95

(16K Disk) \$24.95



## SPACE AMBUSH

Stranded on planet Orgath, the first attack of marauding hoodlums left you with no vertical boosters. Galaxy treaties restrict your weapons to short-range phasers. Can your keen eye fend off another attack? (Requires 16K)

(16K Cass) \$21.95

(16K Disk) \$24.95

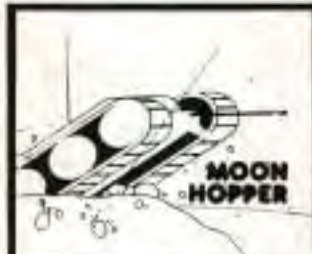

## MOON HOPPER

Roll over the surface with tank-like tractors, hop over any obstacle (cravasses, craters, rocks) & use the phasers (forward and atop) to incinerate attackers as you try to reach Moon Base. High scores shown in 3D space. (Requires 32K)

(32K Cass) \$24.95

(32K Disk) \$27.95



## MEGAPEPE

Megapepe is exponentially more challenging than CENTIPEDES, caterpillars, & others. Caught in a jungle of algae, you're attacked by vicious fleas, mean spiders, & the relentless centipedes. Shoot your way out, gaining points with every hit. (Requires 16K)

(16K Cass) \$24.95

(16K Disk) \$27.95



## JUNIOR'S REVENGE

The same Junior you've seen in the Kong arcade series! This young but tireless little ape must overcome four screens of obstacles to rescue his father, The King, from mean old Luigi. He will traverse the jungle & the swamp, climb vines, avoid vine gators, dodge Zuzu birds, open locks, & finally conquer Luigi's hideout before he finally frees his big daddy. (Requires 32K)

(32K Cass) \$28.95

(32K Disk) \$31.95



## HYPER ZONE

From the cockpit of your space ship see the 3-D field of hyper space! Dodge oncoming space debris, destroy attacking enemies. The 3-D graphics will have your head dodging approaching objects & listening to things whiz past your windshield! (Requires 32K)

(32K Cass) \$24.95

(32K Disk) \$27.95



## GRAN PRIX

Vroom! Your joystick controls the speed & steering as you race over the track, dodging competing cars. Race against the clock & gain points for distance covered. You can almost taste the road dust & smell the burning rubber! (Requires 32K)

(32K Cass) \$21.95

(32K Disk) \$24.95



## EL DIABLERO

You awake, dazed & confused, in the middle of a desert. You had been learning the techniques of sorcery from an old man from these parts. He told you an evil sorcerer, a diablero, had become his enemy. Now your teacher is missing, you are alone, & you can't seem to remember those techniques. All you recall is the verse (You'll have to play to know the rest! Can you solve the toughest adventure without ordering the clues?) (Requires 16K on cassette or 32K on disk)

(16K Cass) \$19.95

(32K Disk) \$24.95



Computerware is a federally registered trademark of Computerware

## FUN AND GAMES



### CLASSICS: COLOROIDS AND COLOR INVADERS

Asteroids & Invaders are arcade classics. In Coloroids, brightly colored asteroids hurdle towards you & you phaser them to bits with a full 360 degree shooting range. Plus you get Color Invaders where you are at the controls of the space tank, firing at stellar ships & invading critters. Two all time greats in one pack! (Requires 16K)

(16K Cass) \$19.95 (16K Disk) \$22.95



### MAZERACE AND CAPTURE THE FLAG

Two great board games of luck & strategy. In Mazerace a hexagonal matrix is filled with paths & obstacles. You must reach the other side before your opponent. Capture the Flag is similar but runs in real time. Play alone or with a friend. (Requires Ext. BASIC & 16K on cassette or 32K on disk)

(16K Cass) \$19.95 (32K Disk) \$22.95



### STARSHIP CHAMELEON

Your starship changes color at the push of a button to destroy the on-coming super bombs & anti-matter bombs launched by the Gabalatoks above. Watch out for the semi-intelligent aerial bombs that home in on your every move! (Requires 16K)

(16K Cass) \$21.95 (16K Disk) \$24.95



### COLORBOWL FOOTBALL

Big league graphics start the football season! Two players play against each other or one can sharpen his offense against the computer. Use 8 defensive plays, 9 offensive plays, & many formations to win the Colorbowl! (Requires 32K)

(32K Cass) \$24.95 (32K Disk) \$27.95



### BLOC HEAD

Q-BERT never looked so good! You guide Bloc Head from cube to cube, changing the brightly colored surfaces while dodging the dispicable characters that try to push him off! He must clear the cubes to go to the next skill level. (Requires 16K)

(16K Cass) \$26.95 (16K Disk) \$29.95



### DOODLE BUG

In hi-res graphics & great sound, your lady bugs hussle through an intricate maze of barriers & turn-styles, trying to earn points by eating the letters, dots, & hearts. Enemy bugs buzz after you! And watch out for the poison skulls! Another arcade favorite! (Requires 16K)

(16K Cass) \$24.95 (16K Disk) \$27.95

## BUSINESS APPLICATIONS

### WHAT YOU SHOULD KNOW ABOUT COMPUTERWARE® BUSINESS APPLICATIONS

- They have been in use for over 4 years on many 6809 systems. This means they are well tested.
- Complete manuals accompany the systems.
- User-friendly menus make them easy to use.
- They are not accounting tutorials. They assume you know and use sound accounting principles.

### System Requirements

- FLEX or OS-9 operating system
- 64K memory
- Computerware® Random BASIC
- Dual Disk Drives (Payroll requires double-sided drives)

### GENERAL LEDGER

This is a comprehensive double entry accounting system with complete audit trails, closing procedures, and full reporting. The chart of accounts is flexible and the system easy to use. Reports include the General Ledger, Trial Balance, Balance Sheet, Income Statement, and Transaction Register. Your financial information is at your finger tips!

\$249.00

### CHECK LEDGER

This is a single entry bookkeeping system which allows the user to define a chart of income and expense accounts. Year-to-date totals are maintained for each account as well as complete checking account history. By just entering your checking account information, you can have always-current visibility over your income and expense ledgers. Financial statements and taxes are a snap!

\$195.00

### CORRESPONDENCE SYSTEM

We call this the People Manager. It is a very sophisticated people data base system. The system collects name and address information, provides mailing labels or reports of the entire list or any subset upon request. The power of the system lies in the 17 character special code field that is used to identify special characteristics of each person and then can be used to select subgroups for reports and labels used in special marketing or contracts. Tested with data bases of 15 to 9,000 entries this system has been in use with retailers, clubs, churches and professionals for years.

\$149.00

### INVENTORY CONTROL

This system is designed to help the retailer, distributor, or businessman to keep control of this important factor. It stores your cost and quantity information, updates it immediately, and offers you key management reports with useful summaries at any time. With four costs, four locations, selling history, and vendor information for each item, you will always have the facts!

\$195.00

### PAYROLL

This is the most comprehensive payroll you'll find on a microcomputer. Besides collecting key employee information, it allows entry of pay rates for standard hours, overtime, and salary. Hourly, salary, and commissioned employees may be paid weekly, bi-weekly, semi-monthly, and monthly. Two types of special monthly deductions are also accommodated. Year-to-date, quarterly, monthly and current totals are maintained. All federal reporting is done automatically and your state computations are also included.

\$295.00

### ACCOUNTS PAYABLE

This system can give you the tools to plan your business' growth by controlling expenditures and forecasting cash requirements. It helps a small business manage and track its cash liabilities by collecting vendor invoice information and reporting the business' cash commitments and payment history.

\$195.00

### ACCOUNTS RECEIVABLE

All businesses need to know who owes them money! This system provides reliable and timely information regarding the status of all customer accounts. You can know instantly which accounts are past due, forecast how much money to expect to receive for cash flow planning, and keep on top of your customers' credit positions. Customer name, address, credit limit, invoice, and payment information is recorded and reports of all information including customer statements are available upon your request.

\$149.00



P.O. Box 668 • Encinitas, CA 92024  
(619) 436-3512

# PROGRAMMING TOOLS AND LANGUAGES

## COLOR PASCAL

Now you can learn about and program in one of the most popular new languages available without investing in a large computer system. Although our Dynasoft PASCAL is not an 'extended' version, the user will find that virtually any task can be accomplished using the commands available plus external calls to your own routines.

What do you get? THE WHOLE THING: COMPILER, P-CODE INTERPRETER, SUPERVISOR, SAMPLE PROGRAMS, PROGRAM EDITOR, — plus a complete instruction manual with examples. Based on a subset of standard PASCAL, it includes most of the standard control structures but omits some of the more sophisticated data structures and floating point arithmetic. The result is a complete high-level language system which retains most of the flavor and structure of standard PASCAL, but will run on a system with as little as 32K memory and a cassette. Below is a summary of Color PASCAL's features:

Reserved Words					
AND	ARRAY	BEGIN	CASE	CONST	DIV
DO	DOWNTO	ELSE	END	EXTERN	FOR
FORWARD	FUNCTION	IF	MOD	NOT	OF
OR	OTHERWISE	PROCEDURE	PROGRAM	READ	REPEAT
THEN	TO	TYPE	UNTIL	VAR	WHILE
WRITE	WRITELN	NEW	MARK		
Supervisor Commands					
Load	Save	Edit	Compile	Go	Gp
Move	Out				
Editor Commands					
New	Top	Bottom	Up	Out	Down
Dnn	Find	Print	Insert	Kill	Replace

(32K Cass) \$49.95

### Disk PASCAL Includes these added features:

- The compiler can be run in less than 16K, allowing for larger programs. In fact, programs can be larger than memory as code is compiled from the disk.
- Directed I/O allows channeling of the input and output to the screen, printer, or disk. One of the example files provided outputs a file to the screen, printer, or disk at your choice! This means the same program can display, print, or copy files to disk.

### \*\*\* New Features Available \*\*\*

- Complete disk file I/O includes OPEN, CLOSE, CREATE, DELETE, RENAME, FREAD, FWRITE, and even DSIO to read and write to a specific sector!
- Hi-Res color graphics, sound and joystick are supported with procedures such as GMODE, LINE, PCLS, PSET, PPOINT, JOYSTICK, and SOUND.

(32K Disk) \$69.95

Save \$10 — PASCAL with our great Editor (32K Disk) \$89.95



## FOXY GRAF

FOXY GRAF is a complete graphics development package for the assembly language programmer. The very comprehensive manual covers the history of graphics, how the Color Computer graphics work, details Radio Shack and Motorola would not tell, and is written in an enjoyable style. You can program with any mode in any color combination. It is totally relocatable and includes some very useful subroutines you can call from standard BASIC, [e.g. circles, shapes, etc.] If you are serious about learning graphics programming, Foxy Graf is both a tutorial and a tool! (Requires 16K)

(16K Cass) \$29.95

(16K Disk) \$34.95

## COLOR BASIC COMPILER™

If you have ever written a BASIC program only to find that it runs too slow to provide any action and haven't had the courage to learn an assembler; then the Color Compiler™ is the answer. It lets you write your program in easy BASIC and then converts it into fast machine language. After you run your compiled program, you may find it necessary to add some delays because the Color Compiler™ will make your program run an average of 40 times faster.

The Color Compiler™ features a total of 46 commands and functions. Most of these are a subset of Extended Color BASIC. The Color Compiler is limited to integer variables. All floating point and string handling can be done in a BASIC program which calls the compiled program. Passing information from BASIC to compiled programs is very easy. The Color Compiler™ generates position independent code so that you may put the compiled program anywhere in memory, including into a ROM-pack! It requires 32K and a disk drive, leaving 16K of user work space.

Functions Supported				
ABS	INKEYS	JOYSTK	PEEK	PEEK #
PPOINT	RND	SGN	SOR	TIMER
+ >	< -	AND	OR	NOT
Instructions Supported				
CIRCLE	CLS	COLOR	DATA	
DIM	END	EXEC	FOR-STEP-NEXT	
GET	GOSUB	GOTO	IF-THEN-ELSE	
LET	LINE	MOTOR (ON/OFF)	ON n GOTO or GOSUB	
PAINT	PCLS	PCOPY	?MODE	
POKE	POKE #	PRESET	PRINT	
PSET	PUT	READ	REM	
RESTORE	RETURN	SCREEN	SOUND	

(32K Disk) \$39.95

## RANDOM BASIC

Computerware's Random BASIC has been an industry standard in the 6800 and 6809 industry for many years. Available now on the Color Computer, it brings the following advantages to those using advanced operating systems like FLEX and OS-9.

- Thousands of existing programs are transportable between operating systems.
- Extraordinary File Handling Capabilities — ISAM, Random, & Sequential file structures. Fast data file access. Very efficient file design.
- 9 Digits of precision — BCD arithmetic. For those who need extended precision, the OS-9 versions also include an 11 digit version at no extra cost.
- Flexible User Input Commands — "Conversational" programming is a snap with commands designed for easy user input — single character or whole lines.
- Easy Output Formatting — Print Using, automatic pagination, left & right justification, easy columnization and decimal point alignment.
- Programming's Fast — The interpreter provides fast program development and debugging — it is self-documenting with extended variable names. Written by programmer's for programmer's!
- OS-9 version supports graphics, sound, & joystick functions!
- In OS-9 version all OS-9 commands are directly accessible, making it easy to write very powerful utilities.
- Write for detailed brochure.

(64K Flex) \$75.00  
(64K OS-9) \$75.00



# PROGRAMMING TOOLS AND LANGUAGES

## DISK UTILITIES WITH REPAIR



### Repair

- R read a sector into memory buffer
- D display buffer to screen by screen type
- C change selected byte to a new value
- N advance to next sector
- P move backward to previous sector
- W write buffer to sector on disk
- O display parameter settings
- H display command menu
- U change drive unit number
- G locate & read first sector of granule
- F change group of bytes to preset characters
- B exit program & return to BASIC

**Find** display starting, ending & transfer address of binary file

**View** look at the contents of ASCII file

**Print** print formatted disk directory to printer or screen

**Maskill** mass delete with confirm  
(Requires 16K disk)

(16K Disk) \$24.95

## MACRO CONDITIONAL ASSEMBLER (available for RSDOS, FLEX, & OS-9)

The limitations of previous Color Computer Assemblers are Gonnell MAC not only supports all standard 6809 assembler mnemonics and directives, but also thrives on Macros, Conditional Assembly, Repeat Sequences, inclusion of Source Library Files and much more. To top it off, we've included both our great Assembler Cross Reference program XREF, and a FIND start, end, and execution address of binary files program. In conjunction with our Color Scribe™ this is the most complete set of programming, editing, and documenting tools available.

With Mac the limitations of having to put all source in memory, or having all binary in memory are a thing of the past. Mac can handle any size source input file. And with the LIBS command (included in RSDOS and OS-9 versions), you could even assemble source from up to four drives into one output binary file. The Macro capabilities allow you to create standard subroutines only once, and then simply call them when they are needed. Conditional assembly allows you to have only one multi purpose source file, and then conditionally assemble various versions from one source. How did you get by without Mac? very slowly! (Requires 32K disk)

(32K RSDOS) \$49.95 (64K OS-9) \$39.00 (64K Flex) \$39.00

## COLOR MONITOR

All keyboard commands consist of a single alphabetic character, possibly followed by one or more arguments. Any of the commands may be aborted by typing a non-hex character (such as "CR") where a hex number is expected. Additionally, the commands that are capable of producing lengthy output may be aborted by typing a "CR" (ENTER) or BREAK on the keyboard; this will be recognized at the time of the line of output, and the system will return to command level. (Requires 16K)

### Command Set Summary:

- |   |                                |    |                                    |
|---|--------------------------------|----|------------------------------------|
| A | Examine & change A register    | O  | (not used)                         |
| B | Examine & change B register    | R  | Register display                   |
| C | Examine & change CC register   | S  | Binary Save to cassette            |
| D | Examine & change DP register   | T  | Text input to memory               |
| E | Echo to RS 232 I/O device      | U  | Examine & change U register        |
| F | Find a byte string             | V  | Set breakpoint and begin execution |
| G | Go to user's program           | W  | Warm start into BASIC              |
| H | Switch to 64K RAM machine      | X  | Examine & change X register        |
| I | Initialize memory              | Y  | Examine & change Y register        |
| J | Jump (subroutine) to addr      | Z  | Display formatted memory dump      |
| K | Set breakpoint                 | @  | Clear all Breakpoints              |
| L | Binary Load from cassette      | ~  | Use other terminal (RS-232 port)   |
| M | Memory examine & change        | ^  | Re-open last address opened        |
| N | (not used)                     |    | List all currently set breakpoints |
| O | Use Other Terminal             | BR | Break operation                    |
| P | Examine and change PC register |    |                                    |

(32K Cass) \$24.95  
(32K Disk) \$27.95

## THE SOURCERER



The Sourcerer is a menu driven symbolic 6809 disassembler that produces symbolic source code that can be assembled. It is compatible with most editor/assemblers including Tandy's EDITASM+, Micro Works Macro 80C, and Computerware's Macro Assembler. (Requires 16K)

- Symbolic mode provides three modes of operation: Zap, Extended, and Full Symbolic

- Automatic equate generation for labels and symbols outside of disassembly range
- FCC, FCB, and FDB generation (multiple or single FCB and FDB)
- Add or change your FCC, FCB, or FDB table entries between passes
- Written entirely in 6809 machine language for extreme speed. Disassembles any size program in seconds.
- Position independent code is relocatable to any area of memory. Leaves room for object program. Can be located in memory above 58000 if 64K available.
- User defined symbol/label buffer area for maximum flexibility
- Produces files with or without line numbers
- Can produce symbolic labels for all extended addresses
- Included "APPRENTICE" program finds start and end of machine language programs. Disk version also includes FIND and binary COM-PARE utilities.
- Disassemble to disk or cassette, printer, or screen.

(64K FLEX) \$39.95  
(64K OS-9) \$39.95

(16K Cass) \$34.95  
(16K RSDOS Disk) \$39.95

## COLOR CASSETTE ASSEMBLER

Custom developed for the Color Computer, the Color Cassette Assembler supports all 6809 mnemonics, addressing modes along with standard assembler options and directives. It operates as a two pass assembler so both forward and backward references are allowed. To assist you, along with your manual, we include the Motorola Instruction Set Reference Card and documentation on many of the major subroutines in the Color Computer's BASIC. (Requires 32K)

(32K Cass) \$24.95

## COLOR DIAGNOSTICS

The program is menu driven and allows you to check the major functions of the color computer. The six tests included are: 1) Memory to 32K; 2) RS-232; 3) Joysticks; 4) BASIC ROMS; 5) Tape I/O; 6) Sound (Requires 16K)



(16K Cass) \$17.95  
(16K Disk) \$20.95



P.O. Box 668 • Encinitas, CA 92024  
(619) 436-3512

# EDITORS AND WORD PROCESSORS

Computerware offers a full range of editors and word processors on cassette and disk, including versions for all of the favorite operating systems. Whether you want to edit programs, write letters, or prepare full documents you will find just the right software among these many choices.

Our Color Editor is available on cassette and disk. It is an excellent program editor and can double as a small word processor for cassette users. Disk users looking for a full featured program editor for FLEX or OS-9 will appreciate our Advanced Editor. The ultimate is our Color Scribe Word Processor for the Radio Shack disk. It has all the features for program editing plus is a superb word processor with more sophisticated text formatting capabilities than any other. Read the descriptions below and decide which best fits your needs.

## CASSETTE COLOR EDITOR

Whether you're writing BASIC, PASCAL, "C", or assembly language programs, or just writing a letter, the Color Editor can do the job! You can use both the upper & lower case features of the Color Computer, and can print your letters or programs on a printer. It takes full advantage of the keyboard, with many of the commands using the arrow keys without pressing enter. It has change & search commands that work on one or all lines of text, and the ability to copy or move sentences or paragraphs to different locations in your file. You can find & change characters within a line and leave the spacing to the editor. Lines can be inserted, deleted, or moved anywhere with a single command. You can save your entire work or just parts of it and load it later. (Requires 32K)

Line Display / Movement Commands				
LIST	PRINT	FIND	TOP	LINE
BOTTOM	UP	DOWN		
Line Modification / Replacement Commands				
DELETE	MOVE	COPY	REPLACE	EDIT
ADD	INSERT	SHIFT	BELL	TAB
CHANGE	MARGINS			
Cassette Commands				
CLOAD	CSAVE	CWRITE		
Special Commands				
BREAK	RENUMBER	LNUMBER	BRACKETS	EOL
MACRO	REPEAT	LINE CLEAR	BASIC	EXIT
NEW				

(32K Cass) \$24.95

## DISK COLOR EDITOR

Available for Radio Shack DOS, this has all of the features of the Color Cassette Editor plus many more. The display has been expanded to 51 x 24 with upper and lower case. Disk commands for saving and loading are added along with the DIR command for easy directory look-up. And since it uses the disk as an extension of memory, it is easy to edit files larger than memory! (Requires 32K)

(32K Disk) \$29.95

## COLOR SCRIBE™ WORD PROCESSOR



COLOR SCRIBE™ is the perfect word processor for letters and documents. It is also great for programming in BASIC, PASCAL, "C", and assembly language. (A special option allows you to disengage the formatter, allowing more free memory for program editing!)

Scribe provides fast change, search, insert, and delete of text. You can move or copy individual lines or entire paragraphs around with a single command. A special feature — it expands your display to 51 x 24 and adds upper and lower case! Over 20 new line editing commands include capabilities like character insert and delete, skip over words, breaking a line, and more! It includes very versatile and easy-to-use formatting of text with right and left margin justification, automatic paging, centering, and tabs, headings and footings, and much more to make format-

ting your text any way you like a snap! You can even embed control codes for your printer's special directives.

Since Color Scribe™ uses the disk as an extension of memory, you can easily edit text files larger than memory. You can merge several files of text or program to create a new document or program. Those often used letters, paragraphs, and subroutines need be typed only once! Color Scribe™ will print directly to the printer and/or save to disk. A complete, easy-to-understand manual with examples accompanies your disk. (Requires 32K and one disk drive)

(32K Disk) \$49.95

## ADVANCED EDITOR FOR FLEX AND OS-9

This Editor is the perfect program editor for FLEX and OS-9 users. It is also compatible with available text processors for FLEX and OS-9 providing an excellent word processing team! It allows fast change, search, insert, and delete of text. You can move or copy individual lines or entire blocks around with a single command. Since it uses the disk as an extension of memory, it is easy to edit text files larger than memory. You can merge several files to create a new subroutine or program. Those often used calls and subroutines need be typed only once! The Advanced Editor will print directly to the printer and/or save to disk. Over 20 line editing commands including character insert and delete, skip over words, break a line, and more. A complete, easy-to-understand manual with examples is included. (Requires 64K, the FLEX or OS-9 operating system, and one disk drive)

Line Display & Movement				
LIST	PRINT	FIND	TOP	BOTTOM
UP/DOWN	LINE			
Line Modification				
DELETE	MOVE	COPY	REPLACE	APPEND
INPUT	INSERT	CHANGE	OVERLAY	
Disk Commands				
LOAD	SAVE	WRITE	READ	LOG
DOS	MONITOR	MORE TEXT	DO	RETRY
Special Commands				
EDIT	BELL	MARGINS	TAB	ESCAPE
RENUMBER	NUMBER	EOL	MACRO	CTL
REPEAT	LINE CLR	BACK SP		

Over 20 Line editing commands also included but not listed

(64K Flex) \$39.00

(64K OS-9) \$39.00

# HOME AND WORK



## FINANCE

Divided into two categories, Loans and Investments. It makes laborious financial calculations in a flash, making financial decisions faster and easier! (Requires 16K & Extended BASIC)

### Loans program calculates

- 1) Discount of commercial paper
- 2) Principal
- 3) Regular payment
- 4) Last payment
- 5) Remaining balance
- 6) Term of a loan
- 7) Annual interest rate
- 8) Mortgage amortization table
- 9) Declining interest loans

### Investment program calculates:

- 1) Future value
- 2) Annuity value
- 3) Regular deposits
- 4) Regular withdrawals
- 5) Initial investment
- 6) Minimum investment
- 7) Nominal interest rate
- 8) Effective interest rate
- 9) Earned interest table

(16K Cass) \$17.95  
(16K Disk) \$20.95



# HOME AND WORK

## FLEXI-FILER™

This is the most comprehensive and flexible data management system available. It is easy to use and very powerful. (Requires 32K disk & RSDOS.)

- Collect:** Up to 35 fields per record, with up to 240 characters per record. You designate the name of each field, its position, and its format (alphanumeric, numeric, money, date, exponential). The size of your database is unlimited — only your disk space will limit your files.
- Organize:** You determine how the information is displayed and stored. Your format can be changed anytime! Easy screen definition makes data entry simple.
- Select:** Using logical operators (less than, greater than, equal, and, or) you can select any subset of your database with up to 36 different criteria.
- Sort:** All or any selected subset of records can be sorted in ascending or descending order by any of your 35 fields with a very FAST assembly language sort!
- Report:** Design customized reports and labels to fit your individual needs, including page headings with titles, automatic page numbers, and column headers. Numeric fields can be totaled automatically for summaries tool. Printing your information in the format most useful to you is a snap!
- Manual:** Comprehensive documentation describes every feature and operation in easy to read terms.

(32K Disk) \$64.95



Synther - 7

## SYNTH7™

Turn your Color Computer into a musical instrument! No special hardware is required except a TV or video monitor with an audio amplifier. The sound is available at the cassette port as well. (Requires 16K)

- Two octave keyboard with twelve octaves to choose from
- User controls vibrato, bend, boing factor and volume level.
- User controls vibrato pattern, vander rate and attack mode
- User modifiable attack, sustain, decay and release rates allow virtually any ASDR envelope
- Fifty stops available. All may be changed and renamed by the user and saved for later use
- Can be fine tuned to match other instruments or other Color Computers. You could start a band!

(16K Cass) \$21.95  
(16K Disk) \$24.95

## SYNTH77™

If you have 32K of memory you can collect a whole library of music by saving your musical creations on cassette or disk with our new Sequencer feature — in addition to all of the features of Synther 7. With the Synther 77™ you can:

- Record music into memory as you play it. Nearly 2000 individual notes may be stored in 32K. Autorecord allows you to play music until you like it and be sure that it is in memory. Standard record stores music until the buffer is full.
- Play your stored music back. Songs may be played once or continuously.
- LOAD or SAVE stored music to cassette or disk for later playback.
- Stored music may be edited. Change or delete any note and single step through the music to find any mistakes made while recording.

(32K Cass) \$27.95  
(32K Disk) \$30.95

## COLOR DATA ORGANIZER

CDO is a little data base system for small inventories, remember lists, serial numbers, etc. It stores, retrieves, sorts, prints, and totals whatever you want within the two 9 digit numeric and two 16 character string entries. It holds 125 records on cassette or 255 on disk. (Requires 16K & a printer.)

(16K Cass) \$19.95  
(32K Disk) \$29.95



## THE BIO DETECTOR

Now you can plug into those secret, personal reactions! Silver finger sensors attach to the Bio Detector unit which plugs into the joystick slot. Your "galvanic skin response" is plotted with hi-res color graphics and sound! Use the Bio Feedback Program as a true health and relaxation aid. The Anxiety Attack Game will provide hours of embarrassing (and truthful) fun! Now when someone asks "what can you computer do?" hook 'em up!! (All hardware, software, and instructions included.) (Requires 16K) Note: Results not admissible in court.

\$34.95



## THE COLOR CONNECTION

This is the easiest and most complete modem software package available!

- Full and half duplex
- User designated parity
- MACROS for quick log-on and auto dial modems
- Requires only 16K
- Big buffer allows downloading and uploading
- Upload and download text files & set parameters for starting and ending character, & more
- 51 x 24 upper and lower case display with a command line
- The display does not break words when wrapping a line
- 300 baud

Requires 16K on cassette or 32K on disk

(16K Cass) \$34.95  
(32K Disk) \$39.95

## 64K SCREEN EXPANDER

### 64K SCREEN EXPANDER

The 64K Color Computer can have a 51 x 24 upper and lower case display without hardware mods! Use it with BASIC and all assembly language programs that use text displays. Included is a character editor so you can change any of the characters. The Screen Expander works by transferring all of the ROMs to RAM and then modifying them to use its new Hi-Res display. It does not affect your software, stays even after resetting, and looks great even on a TV. The PRINT command is also expanded to work with true coordinate positions, (absolute cursor positioning). You now give PRINT@ the Y and X coordinates of the position you want to print! (Requires 64K)

(64K Cass) \$24.95 (64K Disk) \$27.95

### 3-D DRAWING BOARD

This is a tool for education, entertainment, or serious projects. It helps you draw objects in 3 dimensions and then rotate, change elevation, size, and distance. The drawings can be saved to tape or disk for future use. A complete instruction manual makes operation easy. (Requires Extended BASIC & 16K for cassette or 32K for disk.)

(16K Cass) \$24.95  
(32K Disk) \$27.95



### SEMI DRAW

Drawing pictures is fun and easy with SEMI DRAW! Your computer's keyboard or joystick draws in eight colors with semi alpha graphics 8, 12, or 24. It provides animation capabilities and will dump the picture to a Line Printer VII, Line Printer VII, NEC 8023A, or C Itoh 8510 printer. Just press the space bar to see the HELP display for instructions! Requires 32K with Extended BASIC and makes drawing fun for anyone.

(32K Cass) \$21.95  
(32K Disk) \$24.95



P.O. Box 668 • Encinitas, CA 92024  
(619) 436-3512

# HOME AND WORK

## VERSAMAIL™

VersaMail is a sophisticated mailing list manager for the 64K Color Computer with at least 1 disk drive. Features include:

- Over 800 names may be saved on a single disk. More than 2500 names are possible with 4 drives. The program can put one file on as many as 4 disks which save you from moving the disks around.
- 8 pre-defined address fields. Up to 12 user definable fields.
- Logical selection on any field for labels or screen display.
- User definable label format (1 to 2 across). Extra wide or extra long labels are supported.
- MailMerge feature inserts mailing list data into a form letter and prints it automatically for a very professional looking direct mailing.

(34K Disk) \$19.95



## ADDRESS FACTORY

Perfect for club newsletters, church mailings and business customer lists. It records Name, Address, City-State, Zip, and a special code of 27 characters for each person. You can add, delete, or change information easily. The program prints mailing labels or a listing of all or any selected subset of your names. It sorts the names by zip code or special code. 255 names can be stored with disk, 125 with 32K cassette, or 55 with 16K cassette. (Requires 16K & a printer.)

(16K Cass) \$17.95  
(32K Disk) \$22.95

## VIDEO PLUS composite video monitor interface the industry standard

Connect the Color Computer to any composite video monitor and see a crisp, clear picture with no RF interference! The Video Plus comes with everything you need. It is fully assembled and tested, making it easy to install with NO SOLDERING! There is no need to disable your TV interface. The Video Plus works with any motherboard version. Its easy adjustment optimizes the video signal exactly for your monitor and computer. \$24.95

## VIDEO PLUS II M

This easy-to-install composite video interface connects the new CoCo II with an N15C standard monochrome (amber or green screen) composite video monitor. No soldering is required. And it does not disable your regular TV output!

\$26.95

## HOME MONEY MANAGER

Now you can tell in a nutshell how much money you spent and on what and where your income came from. Just record all of your checkbook activities — each deposit, check, and bank charge. Assign each to any of your account codes and the computer can summarize all of your expenses, income, and cash flow (Records up to 480 transactions.) Yes, it helps balance the checkbook, but also provides such reports as: Summary of Expenses, Summary of Income Sources, list of all checkbook transactions. These make tax time a snap! The disk version includes a program to convert a cassette HMM file to disk and the number of checks is limited only to the available disk storage! (Requires 32K & a printer.)

(32K Cass) \$19.95  
(32K Disk) \$29.95

# ACCESSORIES

## KRAFT JOYSTICK

\$37.95



High performance with linear pots & switch selection between self-centering or free-floating.



## MONITORS

Buy your monitor from Computerware and you get your Video Plus for only \$19.95!!

(Monitor only) See this monitor with Video Plus for only \$57.95!!

Coquille green screen \$104.95  
Coquille amber screen \$124.95  
BMC color \$295.00

## 64K RAM SET

Now including a full board for the CoCo II (requires rev. E or higher motherboard)

\$69.95



## PRINTERS

Gemini 10x w/interface \$419.95  
Citron 8510 w/interface and Gdump program \$459.00  
Batek interface (parallel to serial interface) \$64.95

VIDEO CLEAR for TV output \$14.95  
(eliminates RF interference)

WICO joystick adapter \$18.95  
(interface Atari type joysticks to the Color Computer)

DISKETTES — Nashua brand — double density by  
Pkg. of 5 \$14.95  
Box of 10 \$26.95

## BOOKS

- ★ Your Color Computer by Doug Mosier — excellent ideas, tricks, & review \$12.95
- ★ Color Computer Memory Map by B. Russell \$9.00
- ★ Using Computer Information Services \$12.95



Computerware is a federally registered trademark of Computerware



# ACCESSORIES

**NEW  
LOWER  
PRICES!!**



## DISK SYSTEMS

Half-size drives at no additional charge!

Our disk system use top quality drives plus cable, controller, & manual!

single drive, single sided	\$425 <sup>00</sup>
single drive, double sided	\$475 <sup>00</sup>
dual drives, single sided	\$650 <sup>00</sup>
dual drives, double sided	\$750 <sup>00</sup>

Amdisk — new 3½" dual drives drives only	\$499 <sup>00</sup>
complete system	\$665 <sup>00</sup>

## BUMPER STICKERS!!

\$1<sup>00</sup> each

**PROGRAMMERS DO IT  
A BYTE AT A TIME**

COMPUTERWARE Box 668 Encinitas CA 92024 (619)436-3512

## COMPUSERVE STARTER KIT

The CompuServe Information Service is the world's largest and fastest growing videotex service in North America. Join the hundreds of users that enjoy these services:

- Financial Information
- Electronic News Wires, Weather and Sports
- Simulated "CB"
- Special Interest Groups
- Electronic Banking & Shop-At-Home
- Games Galore!
- Electronic Mail and Nat'l Bulletin Board

The introductory Starter Kit for only \$39.95 includes 5 FREE HOURS of connect time, a Personal ID number and password, a 3-ring binder, CIS User's Guide, telephone list with log-on instructions, and an introductory subscription for TODAY!

\$39<sup>95</sup>

## J+M SYSTEMS CONTROLLER BOARD

for more reliability & gold connectors!

with JDOS \$135<sup>00</sup>

supports double-sided drives and 40 tracks  
with RSDOS \$155<sup>00</sup>

**I ♥ My CoCo**

COMPUTERWARE Box 668 Encinitas CA 92024 (619)436-3512



P.O. Box 668 • Encinitas, CA 92024  
(619) 436-3512

Ask for Computerware Products at Your Local Dealer

Dealer Inquiries Invited

**We also carry: Mark Data, Tom Mix, Frank Hogg, Botek, Kraft, WICO, Star Kits, Dugger's Growing System, Amdek, Signalman, C. Itoh, CompuServe, Comrex, Taxan, Gorilla, Elite Software, Arcade Animation & More! Books Galore! Largest selection of CoCo Products from One Company!**

## ATTRACTIVE AUTHORSHIP PROGRAM

for independent  
programmers who want to  
turn software into cash!

Call or write for details.



CHECK  
VISA  
MASTERCARD



Mail to: COMPUTERWARE®  
P.O. Box 668 • Dept. N2  
Encinitas, CA 92024

CARD # \_\_\_\_\_ EXP \_\_\_\_\_

DESCRIPTION	QTY	PRICE	TOTAL
*SHIP. & TAX TOTAL			

NAME \_\_\_\_\_

ADDRESS \_\_\_\_\_

CITY \_\_\_\_\_ STATE \_\_\_\_\_ ZIP \_\_\_\_\_

SIGNATURE \_\_\_\_\_

\* SHIPPING: Under \$100 — add \$2 surface, \$5 air/Canada

Over \$100 — add 2% surface, 5% air/surface Canada

Calif. Residents add 6% sales tax

# Eight Steps To Writing Solid Software Documentation

By Robert Tyson, Ph.D.

**T**here are three reasons for writing software documentation: (1) so the user can use it, (2) so the user can modify it to his needs and use it, and (3) so the author can debug it or figure out what he wrote months (or years) later. Sooner or later, if you own a computer you will write your own program. You may want to use it, sell it, or just modify or expand it. In any case, you need documentation. The simplest form of documentation is usually a descriptive title, but that is useless for the first reason and inadequate for the second and third. Heavily commented programs (with many REMarks) can usually satisfy reason 3 since the hardware configuration is not often changed, but this requires a lot of memory for the remarks and may still be gibberish six months after the logic flow is forgotten.

To avoid this trauma and make your software useful or marketable, a few guidelines may help. Since the Color Computer popularity has flourished, software is coming out of the woodwork, which makes us all very happy. On the other hand, if the software is good (no matter how good) but we can't use it, it is worth no more than the magnetic domains where it's encoded. From experience as a software user and software author I've compiled (no pun intended) eight steps for generating software documentation. Normally, if you document these items in order, you will have produced an acceptable document for your work. This may seem like common sense, but just page through the manual for the latest utility program you bought or wrote. If it doesn't cover the first seven points, it is missing something.

*(Robert Tyson holds a doctorate in physics and designs and analyzes high energy laser beam control systems using computer simulations. He and his family live in Jupiter, Fla.)*

## Guidelines For Documenting Software

- 1) **What is the purpose for it?**  
Why does it exist, what does it do? Does it speed up file sorting, or does it provide entertainment?
- 2) **In general, how does it work?**  
No details, but is it a printer utility that uses dot-addressable graphics or is it a real-time Adventure game where you respond interactively?
- 3) **What are the hardware and operating system requirements?**  
Does it use 16K non-Extended BASIC, a CoCo, and a tape, or is it a 64K FLEX program with a printer and modem optional?
- 4) **What are the input and output formats and ranges?**  
Does it require one or two word commands with eight letters maximum? Does it allow floating point numerical entry with only graphics output? Or, is it menu driven?
- 5) **How do you make it run and what are your options?**  
Must you `POKE 25,6:NEW` before loading or just insert the disk and type `RUN "A"`? What can you do if you get an overflow error; can you recover the data?
- 6) **What is the runtime?**  
Does the game take four hours to play? Does it take 20 seconds to check memory and then load prior to seeing action on the screen?
- 7) **What is the accuracy?**  
Does it numerically calculate to 10 decimal places or is integer arithmetic used? Will the joystick display "dead" zones?
- 8) **What are the detailed functions and algorithms used?**  
Do not include this if it is copy protected or just for user operation.  
Does it calculate the  $\arcsin(x)$  by a series of 30 terms? Does it overlay memory onto the memory area for screen display and rapidly shift graphics pages for the flashing display? Which RAM hooks does it use?

Commercial software documentation often includes only the first five points. Authors may argue that runtime and accuracy are irrelevant for graphics games, etc., and they may be right, but why not tell the user that "the photon torpedo responds slowly to the fire button and you must lead the target."

Listing 1 is a short program to key into your computer. The following is an example of documentation which covers the points I've addressed and could be used as a model for your own documentation.

**The listing:**

```

10 CLS:FLAG=1
20 PRINT@258,"FACTORIAL CALCULAT
ION"
30 INPUT"NUMBER TO BE CALCULATED
";X
40 X=INT(X):IF X<0 THEN 130 ELSE
IF X>33 THEN 140 ELSE IF X=0 TH
EN 50 ELSE 60
50 X=1:FLAG=0
60 FACT=1
70 FOR K=1 TO X
80 FACT=FACT*K
90 NEXT K

```

```

100 IF FLAG=0 THEN X=0
110 PRINT X;"!=";FACT
120 FLAG=1:GOTO 30
130 PRINT"FACTORIALS OF NEGATIVE
NUMBERS DO NOT EXIST":GOTO 30
140 PRINT"ENTRY IS TOO LARGE, IT
WILL OVERFLOW":GOTO 30

```

This program calculates the factorial of a number. It can be used as a stand-alone program or as a subroutine in another BASIC program. The program accepts input from the keyboard and outputs to the screen only. A Color Computer, 4K non-Extended BASIC, is all that is required.

Factorials exist only for zero or positive integer numbers. The program accepts inputs between 0 and 33. Error messages will occur otherwise. The integer part of a positive non-integer input is used. After keying in the program, type *RUN*. The computer will prompt you for input or errors. For all values the factorial will appear "instantaneously."

Color Computer display capability is nine significant digits; all results were checked against tables and verified to be accurate to eight significant digits. The program uses lines 10-30 to input the data and line 40 for checking the validity of the input value. Since  $0! = 1! = 1$ , a flag is set in line 50. Lines 60-90 do a brute force calculation of the formula  $x! = (1)(2)(3) \dots (x)$ . Lines 100-120 check for the zero flag, output the results and loop to the beginning. Press [Break] to terminate the program.

# YOUR COLOR COMPUTER JUST EARNED A MATH DEGREE!

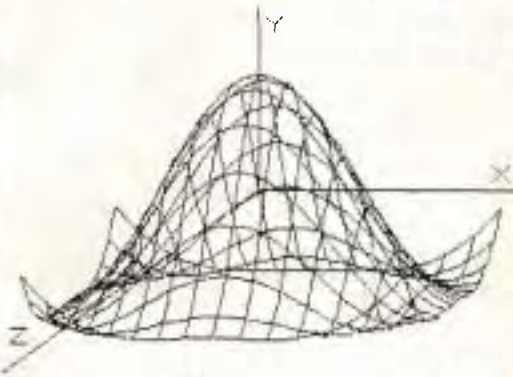

## MATHMENU

Developed by an engineer, *Mathmenu* is a powerful menu-driven system to turn your Color Computer into an intelligent, flexible tool for mathematics and engineering. *Mathmenu* takes the tedium out of math, leaving your full brain power to attack the "meat" of your problems. By rapidly manipulating matrices and vectors, performing integration and differentiation, solving quadratic equations, plotting user defined functions and much more, *Mathmenu* can help simplify the most complex problems. Whether you are a student or a professional, if you use math, you need *Mathmenu*.

### FEATURING:

- 3D SURFACE PLOTTING — Plots a user defined equation on an X,Y,Z coordinate system in the High-Res graphics mode. Planes, surfaces of revolution, statistical surfaces, etc. can be easily plotted. Surfaces may be saved to disk or tape. We believe this is the only program of its kind commercially available for the Color Computer.

### PLUS:

- Complete MATRIX Operations (up to 8 x 8)
- Complete VECTOR Operations
- Numerical Differentiation
- Numerical Integration
- Least Squares Curve Fitting
- Binomial Expansion
- Prime Number Verification
- Main Menu with Single-key Selection and Return (Disk Only)
- 2D Function Plotting
- Rectangular to Polar Conversions
- Base Conversions
- Large Number Addition and Multiplication
- Reverse Polish Logic Calculator with Hexadecimal
- Quadratic Equation Roots

Complete documentation of all functions is included.

For 32K Disk ..... \$49.95  
 For 16K Cassette ..... \$44.95 *Plotting Requires Extended BASIC*  
 Documentation only ..... \$5.00 (refundable with purchase)

Or write for free brochure.

New York residents add 7% sales tax



**Inter**  **Action**

31 Rose Court • Dept. R • Amherst, NY 14226 • (716) 839-0943

## A Joyful Family Experience

By Fran Saito  
and  
Bob Albrecht



### Hello, and Welcome

A long time ago, in a galaxy nearby, the home was the center of learning. Parents and children worked together to pass on knowledge to daughter and son. What was not learned at home was commonly learned by becoming an apprentice who learned from a master. There were few "schools," institutions devoted to teaching instead of learning.

Time passed and schools flourished. In the USA today, schools are becoming increasingly less adaptive to a changing world. Fortunately, something is happening, something that provides rich and highly motivating environments for learning, outside of schools. Millions of people are buying computers for home and personal use. Within a few years nearly everyone will have a computer. There exists an unprecedented opportunity for learners to take control of the means of learning.

As learning moves out of the school into the direct control of learners, once again people are enjoying learning as an adventure. For themselves, their families, their friends and neighbors. Through the use of a home computer, the entire family can work and play together to learn anything from the mundane to the most esoteric subjects, and on a schedule and at a pace chosen by the learners.

"School Is In The Heart of a Child" is for parents of quite young children. We want to help you work and play with your three- to eight-year-old child and learn to use computers as a joyful family experience. We want to suggest ways to incorporate the home computer as another means to encourage your child's independence, growth and control over his own life; see the pride on her face as she directs the computer to do what she with deliberation selects; see her head gears switch to "on" as she progresses step-by-step with your presence and caring direction.

We will explore (we hope, with *your* help) the following:

- Specific "teaching" techniques so that the discovery can be the child's own.
- Critical evaluation of software based on extensive play-testing in family and related environments.
- Additional resources to consult: books, magazines, software publishers, networks, etc.

---

*(Fran Saito holds a degree in education from the University of Hawaii and has taught preschool and elementary students. She feels her inspiration comes from Mariko, her five-year-old daughter, as she has watched her child's curiosity and desire to learn. Fran also speaks fluent Dutch and Japanese.)*

---

Copyright© 1983 by Dragon Quest, P.O. Box 310, Menlo Park, CA 94026

*A wise dragon once said, "School is everywhere and learning is something you can learn to do."*

—Laran Stardrake

- Suggestions for interludes and fun times away from the computer (a must!): call the librarian for specific information; watch a TV program together and discuss it; work together as volunteers in a community project; take a fall (or spring or winter or summer) awareness walk. . . .
- Whatever we learn from families we work with in Menlo Park or from you, our readers, let's pool our knowledge. Let's share our experiences as we all learn from our children.

In addition, we will provide many small programs (beginning this issue!) you can type in and use right now, and information on how to enter and use programs stored on tape cassettes or diskettes.

### Things To Read

One of the best sources of general information on teaching your on children are books by John Holt. We recommend the following titles:

- "How Children Fail"
- "How Children Learn"
- "Teaching Your Own"

Publisher for all three books: Dell Publishing Co., Inc., 1 Dag Hammarskjold Plaza, New York, N.Y., 10017. We suggest you sign up for John Holt's newsletter about teaching your own kids at home.

"Growing Without Schooling," Holt Associates, 729 Boylston Street, Boston, MA 02116.

Although written for users of Atari computers, the following book has much information we think will be useful to you.

Lower, Judy, Ed Neil, and Tim Finger. "Buy a School for Your Home," Reston Publishing Company, 11400 Sunset Hills Road, Reston, VA 22090.

Because you own a CoCo, you subscribe to *the Rainbow*, a magazine devoted entirely to *your* computer. We recommend a second magazine, which specializes in . . . well, the name of the magazine tells you.

"Family Computing," Scholastic, 730 Broadway, New York, N.Y., 10003, \$17.97 per year (12 issues).

If you have a pre-school child, try to get this back issue: Volume 1, Number 3, November, 183. It focuses on computing for very young children. Fascinating stuff.

## Kids Can Teach Computers

The CoCo is a great machine for teaching kids how to use, program, and enjoy computers. In this section of "School Is In The Heart of a Child," we suggest ways in which you and your children can learn together how to tell the CoCo to do what you want it to do.

So, grab a kid and help her or him enjoy — and learn to understand — simple commands and short programs in Color BASIC. We suggest things to do. *You* explain what is happening, answer questions, modify our ideas, and enrich the learning experience with *your* ideas. But don't do the typing. Let the kids do the hands-on stuff. Be patient — let them make mistakes, correct their own mistakes and, especially, encourage them to experiment!

### EXPERIMENT!



Help kids learn to read and understand BASIC. Presto! Many of them will *teach themselves* how to express themselves creatively in BASIC, as if by

### MAGIC!

Some people are not interested in writing original programs. That's okay. They can still *use* and *enjoy* computers, thanks to programs written by people who like to write them.

Perhaps this is part of "computer literacy." After all, more people read novels than write novels; more people listen to

music than compose music; more people use inventions than invent inventions; more people appreciate art than create art.

### Begin

Show your eager young learner how to hook up the Color Computer to a color TV. We assume you know how to do this, including setting the TV channel to 3 or 4. Turn on the Color Computer and the color TV. This is what you might see:

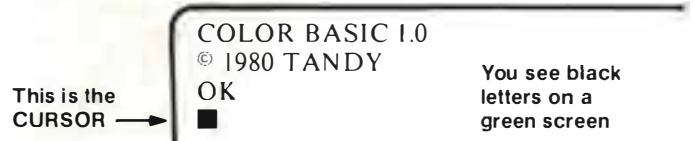

If your screen says Color BASIC 1.2 or Color BASIC 2.3, that's okay. You have your later versions of BASIC than the one we are using. If your CoCo has Extended Color BASIC, you will see an appropriate message on the screen.

Tell them about the *prompt* (OK) and the cursor (■). The cursor continually changes color as it blinks on the screen. When you see the blinking cursor, it is your turn to do something.

Type [C][L][S] and press the [ENTER] key. This is what you see:



Have someone type a name and press the [ENTER] key. This is what happened when Mariko typed her name and pressed the [ENTER] key.

## The KEY-264K is here!!

DO YOU HAVE A 32K SYSTEM WITH 64K MEMORY CHIPS ?? ARE YOU STILL BEING TOLD YOU CAN ONLY USE 32K FROM BASIC ??

DON'T BELIEVE IT !! - KEY COLOR SOFTWARE brings you the KEY-264K. An exciting NEW SOFTWARE utility that allows any STANDARD 32K COLOR COMPUTER TO ACCESS 64K RAM FROM BASIC, and with NO HARDWARE MODIFICATIONS REQUIRED!!!

\*\*\* Works with CASSETTE based systems! \*\*\*

\*\*\* Works with DISK based systems! \*\*\*

The KEY-264K divides the 64K ram memory into two 32K banks or sides, each of which can be utilized independently by the BASIC interpreter, with the ability to switch instantly from one side to the other. IT'S LIKE HAVING TWO COMPUTERS IN ONE!! Have your BASIC program on one side and keep your variables on the other side, or have your main program on one side and your subroutines on the other side, or have your program on one side and use the other side for 4 additional HI-RES pages, or any combination you like. The possibilities are endless because the KEY-264K allows full communication between sides plus the ability to switch back and forth at will, all from within BASIC. You could also have different programs in each side and switch back and forth between them using simple keystrokes, even while the programs are running!! Or run them both at the same time in the FOREGROUND/BACKGROUND MULTI-TASKING mode. Don't buy that printer buffer yet! With the KEY-264K you can be printing in the background side while utilizing your computer normally in the foreground side AT THE SAME TIME!!! Debugging a program? Use either a BASIC command or simple keystrokes to instantly duplicate your program, in it's present status, on the opposite side. Switch to the opposite side later and pick up exactly where you were before!

For DISK users, the KEY-264K allows you to alternate between DISK and EXTENDED BASIC on the same side with simple keystrokes. No need to pull your controller or power down. You can be in EXTENDED BASIC on one side and in DISK BASIC on the other side and still switch back and forth and have full communications between the two sides.

The KEY-264K does this and MORE thru extensions to BASIC. No need to learn a new language! The KEY-264K adds 15 NEW COMMANDS and 1 function to BASIC, including powerful new BLOCK MEMORY MOVE and GRAPHICS VIEWING commands.

The KEY-264K works on 32K systems with "E", "F", or even modified "D" boards and requires EXTENDED or DISK BASIC with GOOD 64K MEMORY CHIPS! Systems with piggy-back 32K or half-good 64K memory chips WILL NOT WORK!!

ORDER YOUR KEY-264K CASSETTE TODAY by sending check or money order for \$39.95 plus \$2.00 postage U.S.A. (\$5.00 outside U.S.A.) Mass. residents add 5% sales tax.

MASTERCARD, VISA, OR COD  
CALL (617) 263-1737

KEY COLOR SOFTWARE  
P.O. BOX 360  
HARVARD, MA. 01451



WORKS WITH THE NEW 64K  
COLOR COMPUTER TOO!!

oops!



OK  
MARIKO  
?SN ERROR  
OK

Oops! The CoCo typed an error message (?SN ERROR). Explain that "The CoCo doesn't understand you." That's okay. Don't worry about occasional misunderstandings. They, and you, will quickly learn how to make the computer understand.

YOU CAN DO NOTHING WRONG.  
MISTAKES ARE OK, PART OF LEARNING.  
EXPERIMENT, TRY AGAIN, HAVE FUN.

Even very young kids can tell the computer to change screen colors.

Find the [CLEAR] key. Press it.

The screen is clear except for the cursor



Two ways to clear the screen to mostly green:

Type *CLS* and press the [ENTER] key.

Press the [CLEAR] key.

Tired of a green screen? Try some other colors. Type *CLS 8* and press the [ENTER] key.

Orange screen except for the top line, which is green

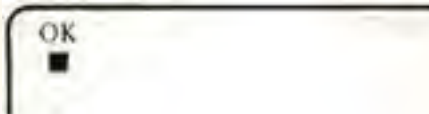

The actual colors will depend on your TV. Adjust the color controls until you get an orange screen with a green top line. More colors? Try these:

**TYPE THIS**

CLS 0  
CLS 1  
CLS 2  
CLS 3  
CLS 4  
CLS 5  
CLS 6  
CLS 7  
CLS 8

**GET THIS**

black screen  
green screen  
yellow screen  
blue screen  
red screen  
buff screen  
cyan screen  
magenta screen  
orange screen

Hmmm . . . what about *CLS 9*? Try it and find out.

**EXPERIMENT!**



**The Sound of SOUND**  
Add some music.

Type *SOUND 89, 20* and press [ENTER]

Did you hear it? If not, turn up the volume on your TV. When you type *SOUND 89, 20* and press the [ENTER]

key, the Color Computer plays a musical tone on the TV's sound system.

You type: *SOUND 147,20*  
A different tone! What's different?

You type: *SOUND 89, 50*  
How is this different from *SOUND 89, 20*?

You type: *SOUND 147,100*  
How is this different from *SOUND 147, 20*?

Aha! The first number is the tone; different numbers give different tones. The second number is the length of the tone; bigger numbers give longer tones. This is also called the *duration* of the tone.

**SOUND 89, 20**

Play this tone for this long

**SOUND 89, 20**

tone duration  
(length of tone)

Try some sounds. Try a low, short tone (*SOUND 1,1*). Try a high, long tone (*SOUND 210, 60*). Try a scratchy tone (*SOUND 255, 20*). What happens when you try these?

SOUND 0, 1 Tone number is 0.  
SOUND 256,1 Tone number is 256.  
SOUND 89, 0 Duration is 0.  
SOUND 89, 256 Duration is 256.

Encourage everyone to discover that tone numbers can be 1 to 255, and duration numbers can be 1 to 255.

Combine color and sound.

Type *CLS 8; SOUND 89, 20* and press [ENTER]  
Colon

You see an orange screen and hear a tone. More than one sound? Of course.

Type *SOUND 89, 10; SOUND 108, 10*  
Colon

Three sounds? Four sounds? Experiment!

**Every Kid A TV Star!**

Enter this short program, then let every kid try it.

```
10 REM**NAME EVERYWHERE SCH1-1
20 CLS
30 INPUT "YOUR NAME"; NS
40 CLS
50 PRINT NS
70 GOTO 50
```



We'll add line 60 later.

RUN it. You will see:

**YOUR NAME?**

Ask someone to type his or her name and press [ENTER]. This is what happened when Mariko typed her name and pressed [ENTER].

MARIKOMARIKOMARIKOMARIKOMARIKOMARI  
 KOMARIKOMARIKOMARKIOMARIKOMARI  
 KOMARIKO

and so on, everywhere on the screen

Oh, it boggles the eyes! Press the [BREAK] key to stop the computer. Then type *RUN* and press [ENTER] to put another name on screen.

- To stop the CoCo, press the red [BREAK] key.
- To run the program, type *RUN* and press the [ENTER] key.
- When the CoCo asks for YOUR NAME, type any name and press the [ENTER] key.

Show your child how to use quotation marks to include spaces before or after her or his name.

YOUR NAME? "MARIKO"    ■ — cursor  
                                   ↑  
                                   Put one space here

Now press [ENTER], and you will see:

MARIKO MARIKO MARIKO MARIKO MARIKO MARIKO  
 MARIKO MARIKO MARIKO MARIKO MARIKO MARIKO

and so on. Also try more than one space after the name.

Of course, you don't have to enter names. Enter any bunch of characters you want. Try an arrow (→) or a snail with a trail (...@) or a shooting star (———\*). EXPERIMENT! Let your fingers wander over the keyboard. Don't let computer comments such as ?EXTRA IGNORED spoil your fun. Some patterns fill the screen and then remain static, others fill the screen and then seem to move left, right, up, down — some even seem to vacillate (or is it oscillate?). Have you figured out why this happens?

Slow things down. Add a *time delay* to the program.

60 FOR KK=1 TO 5: NEXT KK



Now the program looks like this.

```
10 REM**NAME EVERYWHERE SCHI-2
20 CLS
30 INPUT "YOUR NAME"; N$
40 CLS
50 PRINT N$
60 FOR KK=1 TO 5: NEXT KK
70 GTO 50
```

Make the time delay (line 60) shorter or longer.

Shorter: 60 FOR KK=1 TO 2: NEXT KK  
 Longer: 60 FOR KK=1 TO 10: NEXT KK

Or, use *SOUND*. Replace line 60 by one of these.

# Talk is Cheap!

You want your color computer to talk, but how much will it cost?  
 \$50 . . . \$100 . . . \$200 . . . NO!

## HOW ABOUT \$29<sup>95</sup>?

**SPEAK UP!**<sup>™</sup> is a machine language Voice Synthesizer program for your TRS-80 Color Computer.\* It is 100% software. Nothing else to buy. Best of all, YOU can make basic programs talk!

16K and 32K versions on one cassette. Has text to speech capability.

\*T.M. Tandy Corp.                    16k minimum



It's easy to use, and will say virtually anything!

## Talk really is cheap!



Reviewed in the April issue of *Rainbow*.

COD orders, checks accepted - NO DELAY  
 WE PAY POSTAGE

1-800-334-0854, ext. 890  
 Except North Carolina



*Classical Computing, Inc.*

P.O. Box 3318  
 Chapel Hill, NC 27515

60 SOUND 89, 1                      Monotonous sound.  
 or  
 60 SOUND RND(255), 1              Chaotic sound.

Also try other numbers here.  
 5 or 10 or 20 or . . .

Here is a variation of our program.

```
10 REM**NAME EVERYWHERE SCH 1-3
20 CLS
30 INPUT "YOUR NAME"; N$
40 CLS
50 PRINT N$;
60 FOR KK=1 TO 5: NEXT KK
70 K$=INKEY$:IF K$="" THEN 50
80 GOTO 20
```

When this program is running, press any key (except [BREAK] or [SHIFT]) and the CoCo will start over from line 20.

### Playtesting

ComputerKid, USA puts computers in the hands of kids in youth organizations, alternative schools, and at home in order to playtest and evaluate educational software in places that are learner-centered, instead of teacher-centered.

During 1983, ComputerKid organized, managed, and conducted playtesting and evaluations of more than 100 items of educational software for Atari computers. Results appear in the book "Buy a School for Your Home," mentioned earlier in this article.

Your authors will personally playtest CoCo software designed for three- to eight-year-old children and report our

observations and opinions. We will also report on systematic playtesting by ComputerKid, USA.

We have received the following software to evaluate.

- *Early Games* from Counterpoint Software, Inc., Suite 218, 4005 West Sixty-fifth Street, Minneapolis, MN 55435. The cassette version runs on a 16K CoCo with Color BASIC. Extended BASIC is not required. We are especially interested in software that runs on the least expensive CoCo!
- Several educational games from The Learning Company. These are available from Follett Library Book Company, 4506 Northwest Highway, Crystal Lake, Ill., 60014. Toll free 1-800-435-6170. In Illinois: 1-815-455-1100.

*Juggle's Rainbow* (ages 3 to 6)  
*Bumble Games* (ages 4 to 10)  
*Moptown* (ages 6 to 13)

These games are available on cassette for 16K CoCo with Extended Color BASIC or on diskette for 16K.

Amazing! All the above games run on a 16K CoCo with Extended BASIC and a cassette recorder — total cost about \$300 at the time this was written. To run the same games on a Apple requires 48K and a disk drive. Cost? More than \$1,000!

### Help!

If your home has a kid, three to eight years old, and a CoCo, please share your experiences in using your CoCo with your offspring. Fran and Bob, P.O. Box 310, Menlo Park, CA 94026. If you want a reply, please enclose a self-addressed, stamped envelope.

### TRS-80 COLOR BASIC

by BOB ALBRECHT

*Beginners*

This entertaining self-instructional book is packed with games, experiments, scores of intriguing challenges, and activities related to fantasy role-playing games. The ideal introductory aid for kids, parents and teachers using the Color Computer.

John Wiley & Sons \$9.95  
 605 Third Ave., New York, NY 10158

### TRS-80 COLOR COMPUTER GRAPHICS

by DON INMAN

*Intermediate*

Explore the creative and imaginative blending of computers and color. This exciting book will enable you to explore all the graphics capabilities of Extended Color BASIC.

Reston Publishing Company \$14.95  
 11480 Sunset Hills Rd., Reston, VA 22090

### ASSEMBLY LANGUAGE GRAPHICS FOR THE TRS-80 COLOR COMPUTER

by DON INMAN and KURT INMAN

*Advanced*

This book is specific to the TRS-80 Color Computer with applications using sound and graphics to illustrate how an assembler can be used to perform feats that would be quite difficult, if not impossible in the BASIC language.

Reston Publishing Company \$14.95

### DYMAX, P.O. 310, MENLO PARK, CA 94025

Dymax orders must be prepaid via check, money order, Visa or Mastercard. Sorry, no Purchase Orders or COD orders. Please add \$2.00 shipping and handling. California residents add 6% sales tax.



## UNIT ONE SOFTWARE

### PARTS OF SPEECH

Tutors Adjectives, Adverbs, Conjunctions, Interjections, Nouns, Pronouns, Prepositions. Ages 8 to adult. 16K ECB.

\$24.95

### ELEMENTS AND SYMBOLS

Learn Scientific Elements and their Symbols the fun way. Ages 11 to adult. 16K ECB.

\$14.95

### HOMONYMS

Widen a students vocabulary the interesting way. Ages 8 to Adult. 16K ECB.

\$14.95

### NAME THE CAPITALS

Learn the Capitals, the interesting and fun way. Canada, United States, Europe, Australia, South America. 16K ECB.

\$9.95 each or \$39.95 per set.

### THE EDGE

Get an edge with your betting on the horses. Lists all horses per race and gives four top contenders per race. Complete with version for screen and printer output. 32K ECB.

\$29.95

send cheque or money order to:

**UNIT ONE SOFTWARE**

P.O. Box 86472

North Vancouver, B.C.

Canada, V7L 4L1

Teacher and student tested in a private school in British Columbia (B.C. residents add 7%)



# Upgrade Your Color Computer With A Key Tronic Keyboard.

Simple to install in your TRS-80 Color Computer\*. A high-quality Replacement Keyboard from Key Tronic . . . the world's leading keyboard manufacturer for computer terminals.

## FEATURES

- 15-20% higher data input rate compared to standard color computer keyboard.
- User programmable function key.
- Familiar typewriter layout.
- Complete legend description.
- High reliability—keys do not stick or jam.

Additional features include — high spring force on "clear" and "break" keys to prevent entry errors, full sculptured keytop array with low profile keytops, and locating "pips" on home row keys.

## ORDERING INFO:

Suggested Retail Price: **\$89.95**, includes plug adapter, part #500c, for models produced after Oct. '82 (Rev F and later). To order Model **KB-500** call Toll Free: **1-800-262-6006** for the retailer closest to you (7 am- 3pm Pacific Time). Warranty information may be obtained free of charge by writing to the address below.



Radio Shack

TRS-80

COLOR  
COMPUTER



\*Radio Shack is a registered trademark of Tandy Corp.

 **key tronic**

THE RESPONSIVE KEYBOARD COMPANY

Dept. E2 • P.O. Box 14687 • Spokane, Washington 99214 USA

RETAILERS: For the Distributor in your area, call Toll Free 1-800-262-6006 Dept. D (7 am—3 pm Pacific Time)



# RAINBOWfest

## LONG BEACH

The fun and excitement of *RAINBOWfest* is coming your way . . . and now there will be a *RAINBOWfest* near you!

For the 1983-84 season, we've scheduled four *RAINBOWfests* in four parts of the country. Each one will offer fun, excitement, new products, seminars and information for your CoCo! And for those who (perish the thought) don't like CoCo as much as you, we've scheduled each *RAINBOWfest* in an area that will provide fun and enjoyment for the whole family.

Just look at this great lineup:

**Long Beach, California — February 17-19.** What a way to get away from the winter doldrums! And what better place than sunny Southern California with thousands of fellow CoCo owners! Fly with CoCo to the sun for the winter. Top flight seminars will draw on many local CoCo experts.

**RAINBOWfest—Long Beach**

DATES: Feb. 17—19, 1984

HOTEL: Hyatt Regency, Long Beach

ROOMS: \$59 per night single/double

KEYNOTE: Bob Albrecht

Advance Ticket Deadline: Feb. 13, 1984

Water Taxi service available from the hotel to the Queen Mary.

It's a holiday weekend, too—so take Monday off and tour Disneyland, Universal Studios, Marineland, the Queen Mary and Hollywood!

**New Brunswick, New Jersey — March 30-April 1**

*RAINBOWfest* comes to the populous northeast! It's a close drive from New York, Boston, Philadelphia, Washington, Baltimore and Long Island.

**Chicago — June 22—24.** We'll play *RAINBOWfest* again, CoCo! This is the site of CoCo's very first show this spring. And right next to the world's largest indoor shopping mall.

Every show will be held at a Hyatt-Regency Hotel and all will be offering special rates for *RAINBOWfest*. Every show will open at 7—10 p.m. Friday, run 10

**RAINBOWfest—New Brunswick, N.J.**

DATES: March 30—April 1

HOTEL: Hyatt Regency New Brunswick

ROOMS: \$59 per night single/double

KEYNOTE: To Be Announced

Advance Ticket Deadline: March 23, 1984

a.m.—6 p.m. Saturday and close with an 11 a.m.—4 p.m. session Sunday. Each will have a CoCo Community Breakfast featuring an outstanding national speaker from the Color Computer World. And each exhibition will be interspaced with a number of seminar sessions on all aspects of CoCo— from writing in machine language to making your BASIC work better.

But most of all, there will be exhibitors. Lots of them. All ready to demonstrate products of every kind. Some with special programs and hardware items to introduce. Others with show specials.

Tickets can be secured directly from *the Rainbow*. We'll also send you a special reservation form so you can get your special room rate.

Come to *RAINBOWfest* . . . help us all celebrate CoCo Community at its finest!

**RAINBOWfest—Chicago**

DATES: June 22—24, 1984

HOTEL: Hyatt Regency Woodfield

ROOMS: \$46 per night single/double

KEYNOTE: To Be Announced

Advance Ticket Deadline: June 18, 1984



**FREE RAINBOW**

poster for first 500 tickets ordered. FREE T-shirt to first 5 people from each state who buy tickets.

Make checks payable to: *the Rainbow*

MAIL TO:

*RAINBOWfest*  
P.O. BOX 209  
Prospect, KY 40059

YES, I'm coming to *RAINBOWfest* in

—Long Beach    —New Brunswick    —Chicago.

Please send me:

\_\_\_\_\_ three day tickets at \$8 each    total \_\_\_\_\_ \$12 at the door  
 \_\_\_\_\_ one day tickets at \$6 each    total \_\_\_\_\_ \$8 at the door  
 \_\_\_\_\_ specify day    total \_\_\_\_\_  
 \_\_\_\_\_ breakfast tickets at \$11 each    **Handling Charge \$1.00**

TOTAL ENCLOSED (U.S. FUNDS ONLY, PLEASE) \$ \_\_\_\_\_

—Also send me a hotel reservation card for:

—Long Beach    —New Brunswick    —Chicago

NAME (please print) \_\_\_\_\_

STREET & NUMBER \_\_\_\_\_

CITY & STATE \_\_\_\_\_

TELEPHONE \_\_\_\_\_ ZIP CODE \_\_\_\_\_

COMPANY \_\_\_\_\_

Orders sent less than two weeks prior to show opening will be held for you at the door.

VISA, MasterCharge, American Express accepted.

My Account # \_\_\_\_\_ Ex. Date: \_\_\_\_\_

Signature \_\_\_\_\_

# RAINBOWfest Long Beach

## Seminar Program And Speakers

- Saturday 2/18/84 1:00 p.m. **Don Inman** **Using And Teaching LOGO**  
*Don is one of the most respected names in the Color Computer field and an expert on graphic techniques in both BASIC and assembly language. His Using Graphics column appears monthly in the Rainbow.*
- Saturday 2/18/84 12:30 p.m. **Phil Kitchen** **Radio Shack Software Support**  
*Manager of Software Support for Radio Shack, Phil will explain how the Tandy third party software support program works and answer questions about how Radio Shack can be of assistance to authors.*
- Sunday 2/19/84 12:00 p.m. **Paul Searby** **Software Theft**  
**Martin Goodman and Bob Rosen**  
*A panel discussion of one of the most important issues in the CoCo field with Mr. Searby of Computerware and Dr. Goodman of Cheshire Cat Software and Bob Rosen of Spectrum Projects.*
- Saturday 2/18/84 2:30 p.m. **Linda Nielsen** **Women's Programs**  
*Linda, of Moreton Bay Laboratory, and several others active in the CoCo area, will lead a discussion on women's involvement in computing in general and the Color Computer in particular. Theme of the program: It's Not A Man's World.*  
  
*For women and men who view computers mainly as an annoyance, a special seminar is planned on the general topic How To Live With A Computer At Home.*
- Sunday 2/19/84 2:00 p.m. **Bill Nolan** **Fantasy Gaming And CoCo**  
*DungeonMaster, programmer and Rainbow Columnist, Bill has developed a complete Dungeons and Dragons program for CoCo.*
- Saturday 2/18/84 4:30 p.m. **The Dragons of Menlo Park** **Open Forum**  
*Members of the Dymax group—including Bob Albrecht, Don and Kurt Inman—and a host of others—will conduct a "laidback California" open discussion on software and book authorship.*
- Saturday 2/18/84 3:00 p.m. **Jim Reed** **Writing For Rainbow**  
*Jim, Managing Editor of the Rainbow, will talk about how you can submit programs and articles to magazines for fun and profit.*  
**CoCo Classroom**  
*Sharpen your programming skills and learn about LOGO. Introduce your computer illiterate friends to the wonderful world of CoCo. Classes will be conducted by trained Radio Shack instructors.*  
**AND:** *A special session on assembly language programming . . . and more to be announced later.*

## PLUS . . . RAINBOWfest's "CoCo Community" Breakfast featuring Bob Albrecht, Popular Author and Rainbow Columnist

Bob Albrecht and Don Inman will be available at Radio Shack's booth to sign copies of *Color LOGO Guide for Teachers* and *Color LOGO Guide for Parents*.

Additional seminars are planned as well. Admission to all seminars is at no charge. See registration form for admission prices to exhibit area and breakfast.

**COME TO RAINBOWfest LONG BEACH — IN SUNNY SOUTHERN CALIFORNIA**

# Net Results

By Richard A. White

## A Basketball Statistics Program For Your CoCo

**R**ight now we are well into basketball season. Some of you certainly are playing, coaching or helping. Others have family members involved. Or perhaps you are a fan and supporter of the old Alma Mater. In any case, someone associated with your favorite teams sits down with calculator and typewriter after each game for the thankless task of working up the latest team statistics. Now you can bring CoCo to their rescue with these two statistics programs. They require a 32K Extended BASIC machine, but you can keep the files on tape or disk and can move files back and forth if you wish.

*BSKBINIT* is designed to generate the BASIC files and revise them to start a new season. *ENTRDATA* is used to enter box score data from each game, update the year-to-date and career records for each player, and print the updated statistics along with team and opponents totals. This report is fully formatted in condensed (16.7 characters per inch) type by a Radio Shack LP VIII printer or equivalent. The formatted report can also be routed to a disk as an ASCII file for transfer to an automatic typesetter. (The program was written for *the Rainbow's* sister publication *SCORECARD* which reports on University of Louisville sports and whose typesetter is set up to read ASCII files from CoCo disks.)

Start by loading *BSKBINIT* and choosing 1 START NEW CAREER STATS FILE. First, you enter a player's name in the format "I. Name," that is, first initial, a period, a space and the last name. This is important since the alphabetical sort looks for the last name starting at the fourth

position in a string. If you make a mistake, don't worry. You can correct any data entered with the EDIT/CORRECT EXISTING FILE routine. Also remember the total length of the name cannot exceed 13 characters — the periods are there when you enter a name to remind you of this.

After the name is in, the program asks for the career data for the player starting with "G" which stands for total number of games played. Hit the [ENTER] key here and the program assumes there are no games and no career data and goes to the name of the next player. When there is no career data, *ENTRDATA* maintains a career data file which is identical to the year-to-date file and only prints career data on the statistical report when it is different from year-to-date.

The program keeps the data on each player which is shown in the following list along with item number and abbreviation as used in the program or on the printed report.

1 G	Total Games Played
2 GS	Games Started
3 MIN	Minutes Played
4 FG	Field Goal
5 FGA	Field Goals Attempted
6 3PT GF3	Three-Point Field Goals
7 3PTFGA3	Three-Point Field Goals Attempted
8 FT	Free Throws
9 FTA	Free Throws Attempted
10 REB	Rebounds
11 ASST	Assists
12 PF	Personal Fouls
13 D	Disqualifications
14 STL	Steals
16 BLK	Blocked Shots
17 TOVR	Turnovers
18 DUNK	Dunk Shots

*(Richard White has a long background with micro-computers and specializes in BASIC programming. With Don Dollberg, he is the author of the TIMS data base management program.)*

You can add new players to an existing file at any time. The new player is put at the end of the list. I strongly recommend that once you have initialized a file that you sort it alphabetically and leave it that way for the rest of the season. The *ENTRDATA* program makes game data files which are stored according to the order of the player list at that time. Adding players to the bottom of the list won't upset the relationship of player to game data while an alphabetical sort with added players will. There is a SORT ON AVERAGE routine in *ENTRDATA* that lets you sort a file that has been saved so the report can be printed starting with the player with the highest average. Here again, the file sorted by average should not be saved since it cannot be related to back game data files.

Data entry is simple, as the category for data to be entered is the last one to appear on the screen. Simply key in the right number and press [ENTER]. If you press [ENTER] only, a zero is entered.

Once you have entered all your initial data into the career file, edited it as necessary and sorted it alphabetically, save it to tape or disk. It is now ready to use with *ENTRDATA* for game data entry. Now load and run *ENTRDATA*. When you choose 1 ENTER NEW GAME STATISTICS, you are asked LOAD FROM 1 TAPE OR 2 DISK. The program expects you to have the tape or disk with your latest file named CURRSTAT ready. If you use a disk, the newest version is always saved out over the old version unless you change disks. I suggest that you let this happen since past data is of little value and will exist in printed form. But, be sure to backup the disk after each game. A single "1" or "2" keystroke starts the loading.

Now you are asked to enter the game date in the format MM-DD-YY. This will be used as the game file name and the disk is fussy about what's in a name. An extra "/" or "." will bomb the program. I know, since I did it. Do just what the prompts say and stay out of trouble. Game data entry starts with display of the first player's name and a 3 MIN? followed by the cursor. If the player did not play, key [ENTER] and the program will fill out that entry with zeros and display the next name. When you enter a number, the program enters a 1 after 1 G and displays 2 START=1. This prompts you to enter a 1 if the player started the game or simply an [ENTER] if he did not. From here on, data is entered as you did when you made the initial file.

When data is entered for each player, the opponent's game stats are requested. These are the box score totals and not individual player data. This done, the program pauses to update all its career and year-to-date files. Team and dead-ball rebound data is now requested and SAVE TO 1 TAPE OR 2 DISK appears. Don't worry about errors in the file. At this point we want to be sure to get the data that was entered safe. We can correct later and save an updated version. By the way, two saves of two files are always made to tape. CURRSTAT is saved first and then the game file is saved. If you want to preserve your game files, make sure to use new tapes each time or different sections of a tape. If you edit an old game file, be sure to do it with the latest CURRSTAT file in the machine. Disk drive owners can keep the current CURRSTAT file and a season full of game files on one disk without problems.

After data is saved, the program returns to the Main Menu. If there were mistakes, choose 2 EDIT/CORRECT CURRENT GAME and get the job done now. As the game file is edited, the career and year-to-date files are revised as well. Remember that *ENTRDATA* automatically makes a

save of the latest files when it leaves any data entry or editing routine.

With all in order you are now ready to print the statistics. First, call 5 SORT ON AVERAGE. This puts the CURR-STAT file in memory in order by average. As a debugging aid, the order of the averages is printed each time a swap is made. If this bothers you, delete line 825. Next, choose 4 PRINT STATISTICS. The next menu you see was borrowed from another program and works differently. Use the up or down arrow keys to move the pointer to your choice then key [ENTER]. To change the Baud Rate, move the pointer to RESET BAUD RATE, key [ENTER] and enter your new BAUD RATE. The program accepts rates from 110 to 4800.

Using condensed type, the entire report prints on one 8½ x 11 page. For some applications like school newspapers and sports newsletters, you may find it suitable for publication directly. Printer codes used are for the LP VIII and succeeding Radio Shack nine-wire printers. If you need to change these, CHR\$(27)CHR\$(20) in line 625 sets the condensed type. CHR\$(15) in line 636 starts underlining. CHR\$(14) in line 640 stops the underlining. Underline printer codes also appear in line 682.

At season's end, pack your tapes or disks away until next year. To start off the new season, load last season's final results into *BSKBINIT* and choose 6 UPDATE TO START NEW SEASON. This routine lets you delete graduated players and zero's the year-to-date file. Add new players, do the annual alphabetical sort and save the file to the disk or tape for the new season. If you are on disk, put the *BSKBINIT* and *ENTRDATA* programs on the new disk and you are ready for the first tipoff.

Rainbow Check Plus		
22	..... 0187	36
120	..... 0502	57
210	..... 06F5	37
310	..... 0AA1	44
830	..... 0D10	122
980	..... 104D	176
END	..... 122F	86

#### Listing 1:

```

0 GOTO2010' BSKBINIT - A FILE I
INITIALIZATION UTILITY (
C) COPYRIGHT 1983 RICHARD A. W
HITE
1 I$=INKEY$: IF I$="" THEN I ELSE I=VA
L(I$): RETURN
11 PRINT@64, "" : PRINT USING FT$; "1
G" : RETURN
12 PRINT@80, "" : PRINT USING FT$; "2
GS" : RETURN
13 PRINT USING FT$; "3 MIN" : RETURN
14 PRINT USING FT$; "4 FG" : RETURN
15 PRINT@144, "" : PRINT USING FT$; "
5 FGA" : RETURN
16 PRINT USING FT$; "6 3PT FG" : RET
URN

```

## MASTER DIRECTORY V2

Can you find that program you saved last month? Do you have many diskettes with multiple copies and need to organize your life? MASTER DIRECTORY V2 to the rescue! In only seconds add each diskette to MASTER DIRECTORY V2. Now ask MASTER DIRECTORY to find that lost program. Can't remember the filename? Ask for all the files that begin with the letter "C" or ask for all files with an extension of BAS.

What! Two files with the name CATS? Drats! Wait! The file on disk #5 was added on Oct. 5 and the file on disk #9 was added on Nov. 10. Hey fantastic!

Now let's get back to work. Let's see DIR. Hey! How did the filenames get in sequence? Yes, MASTER DIRECTORY V2 will sort the directory and remove the null directory entries. It also saves a copy of the allocator and the directory to protect against those nasty disk errors. Listing may be directed to the TV or the printer. Over 100 diskettes and 3000 filenames can be contained in one master directory.

Buy MASTER DIRECTORY V2 for only \$29 pp. Requires 32K DOS (1.0 or 1.1)

## DUAL CASSETTE COPY SYSTEM

Allows the use of two cassette recorders. Only \$49 pp.

## DISPLAY NOISE ELIMINATOR

Easy to install. Does not violate COCO warranty. \$14pp.

## SCRUNCH

Removes spaces from basic programs. Saves memory and improves speed. Only \$3.00pp or FREE with any order.

FREE CATALOG with order or send self addressed stamped envelope.

Send check or money-order to:

**COCOPRO**  
**P.O. BOX 37022**  
**ST. LOUIS, MO 63141**

Postage paid on all pre-paid orders in U.S.  
Missouri residents add 5.625 percent sales tax.

**DEALER INQUIRES INVITED.**

```
17 PRINT@176,"";:PRINTUSINGFT$;"
7 3PTFGA";:RETURN
18 PRINTUSINGFT$;"8 FT";:RETURN
19 PRINT@208,"";:PRINTUSINGFT$;"
9 FTA";:RETURN
20 PRINTUSINGFT$;"10 REB";:RETUR
N
21 PRINTUSINGFT$;"11 ASST";:RETR
URN
22 PRINTUSINGFT$;"12 PF";:RETURN
23 PRINT@304,"";:PRINTUSINGFT$;"
13 DISQ";:RETURN
24 PRINTUSINGFT$;"14 STEALS";:RE
TURN
25 PRINT@336,"";:PRINTUSINGFT$;"
15 BLOCKS";:RETURN
26 PRINTUSINGFT$;"16 TRNOVRS";:R
ETURN
27 PRINT@368,"";:PRINTUSINGFT$;"
17 DUNKS";:RETURN
30 GOSUB11:PRINTCR(PL,1):GOSUB12
:PRINTCR(PL,2):GOSUB13:PRINTCR(P
L,3):GOSUB14:PRINTCR(PL,4):GOSU
B15:PRINTCR(PL,5):GOSUB16:PRINTC
R(PL,6):GOSUB17:PRINTCR(PL,7)
31 GOSUB18:PRINTCR(PL,8):GOSUB19
:PRINTCR(PL,9):GOSUB20:PRINTCR(P
L,10):GOSUB21:PRINTCR(PL,11):GOS
UB22:PRINTCR(PL,12):GOSUB23:PRIN
TCR(PL,13)
32 GOSUB24:PRINTCR(PL,14):GOSUB2
5:PRINTCR(PL,15):GOSUB26:PRINTCR
(PL,16):GOSUB27:PRINTCR(PL,17):R
ETURN
35 PRINT:PRINT"PREPARE RECORDER
AND TAPE","PRESS ANY KEY WHEN RE
ADY":GOSUB1:PRINT:PRINT"WANT TO
RUN PAST LEADER? Y/N":GOSUB1:IFI
$="Y"THENMOTORON:FORK=1TO6000:NE
XT:MOTOROFF
36 RETURN
100 PL=1:CLS:PRINT:INPUT"TEAM NA
ME- 8 CHARACTERS MAX. ";SC$:IF
LEN(SC$)>8THENSC$=LEFT$(SC$,8)
110 CLS:PRINT@6,"INITIALIZE PLAY
ERS":PRINT"PLAYER NAME .....
.....":PRINT@45,"";:LINEINPUTNA$
(PL):IFLEN(NA$(PL))>13THENNA$(PL
)=LEFT$(NA$(PL),13):PRINT@45,NA$
(PL)
120 GOSUB11:INPUTCR(PL,1):GOSUB1
2:INPUTCR(PL,2):GOSUB13:INPUTCR(
PL,3):GOSUB14:INPUTCR(PL,4)
130 GOSUB15:INPUTCR(PL,5):GOSUB1
6:INPUTCR(PL,6):GOSUB17:INPUTCR(
PL,7)
140 GOSUB18:INPUTCR(PL,8):GOSUB1
9:INPUTCR(PL,9):GOSUB20:INPUTCR(
PL,10)
150 GOSUB21:INPUTCR(PL,11):GOSUB
```

```

22: INPUTCR(PL, 12):GOSUB23: INPUTC
R(PL, 13)
160 GOSUB24: INPUTCR(PL, 14):GOSUB
25: INPUTCR(PL, 15):GOSUB26: INPUTC
R(PL, 16):GOSUB27: INPUTCR(PL, 17)
180 PRINTCHR$(94)" FOR MENU
enter NEXT PLAYER";:GOSUB1:IFI$=
CHR$(94)THEN1000ELSEPL=PL+1:GOTO
110
200 CLS:PRINTTAB(8)"PLAYERS IN F
ILE":PA=32:FORX=1TO18:PRINT@PA,U
SING"###";X;:PRINT" "NA$(X);:PA=P
A+16:NEXT:PA=PA+32:PRINT@PA,"ENT
ER # OF PLAYER TO REVIEW/EDIT"CH
R$(94)" FOR MAIN MENU";:INPUTI$:
I=VAL(I$)
210 IFI$=CHR$(94)THEN1000ELSEIFI
<1ORI>18THEN200
220 PL=I:CLS:PRINT@6,"REVIEW CAR
EER STATS"::PRINT@32,NA$(PL)
230 GOSUB30:PRINT:PRINT"ENTRY #
TO CHANGE "CHR$(94)" WHEN DON
ENTER 'N' FOR NAME";:INPUTI$:IF
I$=CHR$(94)THEN200ELSEI=VAL(I$):
IF(I<0ORI>17)ANDI$<>"N"THEN220
240 PRINT@416,"":PRINT:IFI$="N"
HENPRINT@416,"PLAYER NAME .....
.....":PRINT@429,"":LINEINPU
TNA$(PL):IFLEN(NA$(PL))>13THENNA
$(PL)=LEFY$(NA$(PL),13):PRINT@48
,NA$(PL):GOTO230ELSEPRINT@48,NA$
(PL):GOTO230
250 PRINT@416,"ENTER NEW VALUE F
OR ENTRY":INPUTCR(PL,I):GOTO230
300 CLS:PRINT@8,"caution caution
","THIS ROUTINE WILL ZERO OUT TH
E CURRSTAT FILE EXCEPT FOR CARE
ER DATA. TO PRESERVE LAST YEAR'S
RECORDS, MAKE A BACKUP DISK,
PLACE LAST YEARS DISK ON FILE
AND BEGIN THIS YEAR ON THE NE
W DISK.":PRINT
302 PRINT:PRINT"DO YOU WANT TO Q
UIT THIS ROUTINENOW TO MAKE BACK
UP DISK? Y/N"
304 GOSUB1:IFI$="Y"THENENDELSEIF
I$<>"N"THEN304
305 CLS:PRINTTAB(8)"PLAYERS IN F
ILE":PA=32:FORX=1TO18:PRINT@PA,"
";:PRINTUSING"###";X;:PRINT" "NA$
(X);:PA=PA+16:NEXT:PA=PA+32:PRIN
T@PA,"ENTER # OF PLAYER TO DELET
E",CHR$(94)" CLEAR FILES &GOTO M
AIN MENU";:INPUTI$:I=VAL(I$)
310 K=I:IFI$=CHR$(94)THEN350ELSE
IFI<1ORI>18THEN300
315 PRINT@416,"":PRINT:PRINT@416
,"DELETING "NA$(I)
320 IFNA$(K+1)<>" "THENK=K+1:GOTO
320

```

```

330 FORX=I TOK-1:NA$(X)=NA$(X+1)
:FORY=1TO18:CR(X,Y)=CR(X+1,Y):NE
XT:NEXT:NA$(K)="" :FORY=1TO18:CR(
K,Y)=0:NEXT:GOTO300
350 FORK=1TO18:FORL=1TO18:CM(K,L
)=0:NEXT:OP(K)=0:NEXT:FORK=1TO5:
RB(K)=0:NEXT:GOTO1000
800 CLS:PRINT@162,"sorting":PL=1
:FORX=0TO18:FORY=0TO18:TM(X,Y)=0
:TR(X,Y)=0:NEXT:OD(X)=X:NEXT
810 L1=LEN(NA$(PL)):L2=LEN(NA$(P
L+1)):IFL2=0THENIFFL=1THENPL=1:F
L=0:GOTO810ELSE840
820 IFRIGHT$(NA$(PL),L1-3)>RIGHT
$(NA$(PL+1),L2-3)THEN830ELSEIFRI
GHT$(NA$(PL),L1-3)<RIGHT$(NA$(PL
+1),L2-3)THENPL=PL+1:GOTO810ELSE
IFLEFT$(NA$(PL),1)<LEFT$(NA$(PL+
1),1)THENPL=PL+1:GOTO810
830 FL=1:TP$=NA$(PL):NA$(PL)=NA$
(PL+1):NA$(PL+1)=TP$:TP=OD(PL):O
D(PL)=OD(PL+1):OD(PL+1)=TP:PL=PL
+1:GOTO810
840 FORX=0TO18:FORY=0TO18:TM(X,Y
)=CM(OD(X),Y):TR(X,Y)=CR(OD(X),Y
):NEXT:NEXT:FORX=0TO18:FORY=0TO1
8:CM(X,Y)=TM(X,Y):CR(X,Y)=TR(X,Y
):NEXT:NEXT:GOTO1000
900 CLS:PRINT:PRINT"SAVE TO 1 TA
PE OR 2 DISK":GOSUB1:IFI<1ORI>2T
HEN900
910 D=1:IFI=1THEND=-1:GOSUB35
920 OPEN"D",#D,"CURRSTAT":PRINT#
D,DC$:PRINT#D,SC$:FORK=0TO18:PRI
NT#D,NA$(K):FORL=0TO18:PRINT#D,C
R(K,L):PRINT#D,CM(K,L):NEXT:PRIN
T#D,OP(K):NEXT:FORK=1TO5:PRINT#D
,RB(K):NEXT:CLOSE
930 IFDFT$<>" "THENOPEN"D",#D,DT$:
PRINT#D,OP$:PRINT#D,DT$:FORK=1TO
18:FORL=1TO18:PRINT#D,GM(K,L):NE
XT:PRINT#D,OG(K):NEXT:FORK=1TO4:
PRINT#D,GR(K):NEXT:CLOSE
940 IFI=1THENI=0:MOTORON:FORK=1T
O600:NEXT:GOTO920ELSE1000
950 CLS:PRINT:PRINT"LOAD FROM 1
TAPE OR 2 DISK":GOSUB1:IFI<1ORI>
2THEN950
960 D=1:IFI=1THEND=-1
965 PRINT:PRINT"PREPARE DISK OR
TAPE","PRESS ANY KEY WHEN READY"
:GOSUB1
970 OPEN"I",#D,"CURRSTAT":INPUT#
D,DC$:INPUT#1,SC$:FORK=0TO18:INP
UT#D,NA$(K):FORL=0TO18:INPUT#D,C
R(K,L):INPUT#D,CM(K,L):NEXT:INPU
T#D,OP(K):NEXT:FORK=1TO5:INPUT#D
,RB(K):NEXT:CLOSE
980 IFDFT$<>" "THENOPEN"I",#D,DT$:
INPUT#D,OP$:INPUT#D,DT$:FORK=1TO

```

```

18:FORL=1TO18:INPUT#D,GM(K,L):NE
XT:INPUT#D,G(K):NEXT:FORK=1TO4:I
NPUT#D,GR(K):NEXT:CLOSE
1000 CLS:PRINT@10,"MAIN MENU":PR
INT:PRINT" 1 START NEW CAREER ST
ATS FILE":PRINT:PRINT" 2 ADD PLA
YERS TO EXISTING FILE":PRINT:PRI
NT" 3 EDIT/CORRECT EXISTING FILE
":PRINT:PRINT" 4 SAVE FILE":PRIN
T:PRINT" 5 LOAD FILE"
1002 PRINT:PRINT" 6 UPDATE TO ST
ART NEW YEAR":PRINT:PRINT" 7 ALP
HABETICAL SORT";
1010 GOSUB1:ONI GOTO100,1020,200
,900,950,300,800:GOTO1000
1020 PL=1
1030 IFNA$(PL)=" "THEN110ELSEPL=P
L+1:GOTO1030
2010 CLEAR2000:DIMNA$(18),CR(18,
18),CM(18,18),GM(18,18),OG(18),O
P(18),GR(4),RB(5),OD(18),TM(18,1
8),TR(18,18):FT$="% %":GOT
O1000
36970 PRINT:PRINT"FILE NAME IS '
INITSTAT'

```

		640 .... 10C9	143
	Rainbow	654 .... 1352	173
	Check	666 .... 1604	119
	Plus	684 .... 188A	241
20 .... 019F	81	696 ... 1BAB	77
110 .... 04D2	95	704 .... 1E26	30
170 .... 0777	86	910 .... 20F1	115
210 .... 0A5E	137	980 .... 2328	138
610 ... 0DB5	226	END ... 24D6	69

Listing 2:

```

0 GOTO2010' ENTRDATA - GAME DATA
ENTRY AND PRINTING UTILITY
(C) COPYRIGHT 1983 RICHARD A.
WHITE
1 I$=INKEY$:IFI$=""THEN1ELSEI=VA
L(I$):RETURN
11 PRINT@64,"";:PRINTUSINGFT$;"1
G";:RETURN
12 PRINT@80,"";:PRINTUSINGFT$;"2
GS";:RETURN
13 PRINT@96,"";:PRINTUSINGFT$;"3
MIN";:RETURN
14 PRINT@128,"";:PRINTUSINGFT$;"
4 FG";:RETURN
15 PRINT@144,"";:PRINTUSINGFT$;"
5 FGA";:RETURN
16 PRINTUSINGFT$;"6 3PT FG";:RET
URN
17 PRINT@176,"";:PRINTUSINGFT$;"
7 3PTFGA";:RETURN
18 PRINTUSINGFT$;"8 FT";:RETURN
19 PRINT@208,"";:PRINTUSINGFT$;"
9 FTA";:RETURN
20 PRINTUSINGFT$;"10 REB";:RETUR

```

```

N
21 PRINTUSINGFT$;"11 ASST";:RETU
RN
22 PRINTUSINGFT$;"12 FF";:RETURN
23 PRINT@304,"";:PRINTUSINGFT$;"
13 DISQ";:RETURN
24 PRINTUSINGFT$;"14 STEALS";:RE
TURN
25 PRINT@336,"";:PRINTUSINGFT$;"
15 BLOCKS";:RETURN
26 PRINTUSINGFT$;"16 TRNOVRS";:R
ETURN
27 PRINT@368,"";:PRINTUSINGFT$;"
17 DUNKS";:RETURN
30 GOSUB11:PRINTGM(PL,1):GOSUB12
:PRINTGM(PL,2):GOSUB13:PRINTGM(P
L,3):GOSUB14:PRINTGM(PL,4):GOSU
B15:PRINTGM(PL,5):GOSUB16:PRINTG
M(PL,6):GOSUB17:PRINTGM(PL,7)
31 GOSUB18:PRINTGM(PL,8):GOSUB19
:PRINTGM(PL,9):GOSUB20:PRINTGM(P
L,10):GOSUB21:PRINTGM(PL,11):GOS
UB22:PRINTGM(PL,12):GOSUB23:PRIN
TGM(PL,13)
32 GOSUB24:PRINTGM(PL,14):GOSUB2
5:PRINTGM(PL,15):GOSUB26:PRINTGM
(PL,16):GOSUB27:PRINTGM(PL,17):R
ETURN
35 PRINT:PRINT"PREPARE RECORDER
AND TAPE","PRESS ANY KEY WHEN RE

```

# CMJ-IF

## MULTI-FUNCTION PLUG-IN CARTRIDGE FOR TRS 80C & TDP 100 COMPUTERS PROVIDES

\* \* \*

AN EXTENDER  
2 PARALLEL PORTS  
2 COUNTER/TIMERS  
1 SERIAL COMM. LINE  
SPEECH SYNTHESIS  
4 OR 8K EPROM/ROM SPACE  
SPEECH FROM TEXT, BASIC, RTTY  
INTERFACE FOR 'CMJ-TU  
'(CW,RTTY,SSTV,FAX)

**MAGNUM DISTRIBUTORS INC.**

1000 S. DIXIE HWY. W. #3  
POMPANO BEACH, FLORIDA 33060  
TLX. 514365 305-785-2002





# This is not a game

This is a computer aided learning tool that will pay for itself.

BLACKJACKPRO's 16 programs will condition you to make the right play automatically.

This is a practical approach to mastering the probability based system that experts have been winning with for years.

You'll receive a guidebook to the complete winning strategy. The nine chapters will examine each of the strategies which are guaranteed to

turn the odds in your favor.

Then the computer aided exercises will patiently correct your mistakes and train you to handle any game situation until you are ready to face the casinos and start winning.

With BLACKJACKPRO you'll become a lifelong winner.

Why wait? Simply check your computer on the attached coupon, or call 1-800-223-6015.

*Versions are now available for all major hardware.*

Phone orders may be placed 24 hours a day by calling (212) 582-2006 or (613) 594-7855, or toll-free at 1-800-223-6015.

Mail Orders and Requests for information should be sent to:

**SKILLWARE CORPORATION**  
Applied Probability Dept.,  
2nd Floor, 314 West 53rd, Street New York, New York 10019

BLACKJACKPRO is a trademark of SKILLWARE CORPORATION.  
APPLE II, ATARI, COMMODORE, IBM, and TRS-80 Color Computer, are trademarks of Apple Computer Inc., Atari Inc., Commodore Electronics Ltd., International Business Machines, and Tandy Corp.



Please send me  One,  \_\_\_\_\_  
BLACKJACKPRO tutorials  
@ \$49<sup>us</sup> (\$60<sup>CDN</sup>) each.

For:  APPLE II  IBM P.C.  
 ATARI 400/800/1200  
COMMODORE  64  Vic 20  
 TRS-80 Color Computer

With:  Diskette  Cassettes

Total Amount Enclosed \$ \_\_\_\_\_

N.Y. State Residents please add Sales Tax. Please allow Two Weeks for personal checks to clear.

Name: \_\_\_\_\_

Address: \_\_\_\_\_

City: \_\_\_\_\_

State: \_\_\_\_\_ Zip: \_\_\_\_\_

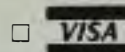

Acct# \_\_\_\_\_

Expiry Date \_\_\_\_\_/\_\_\_\_\_/\_\_\_\_

Signature: \_\_\_\_\_

```

ADY":GOSUB1:PRINT:PRINT"WANT TO
RUN PAST LEADER? Y/N":GOSUB1:IFI
$="Y"THENMOTORON:FORK=1TO6000:NE
XT:MOTOROFF
36 RETURN
100 PL=1:DT$="":GOSUB950:CLS:PRI
NT:INPUT"OPPONENT";OF$:INPUT"DAT
E AS MM-DD-YY.          cau
tion- do not use '/' or '.' whi
ch will cause an FN ERROR  AND
MAY CAUSE YOU TO LOOSE DATA.";D
T$
110 CLS:PRINT@3,DT$"    "OP$,NA$(
PL)
120 GOSUB13:INPUTGM(PL,3):IFGM(P
L,3)=0THENFORY=1TO18:GM(PL,Y)=0:
NEXT:GOTO163
125 GOSUB11:PRINT"    1:GM(PL,1)=
1:PRINT@80,"";:PRINTUSINGFT$;"2
START=1";:INPUTGM(PL,2):GOSUB14:
INPUTGM(PL,4)
130 GOSUB15:INPUTGM(PL,5):GOSUB1
6:INPUTGM(PL,6):GOSUB17:INPUTGM(
PL,7)
140 GOSUB18:INPUTGM(PL,8):GOSUB1
9:INPUTGM(PL,9):GOSUB20:INPUTGM(
PL,10)
150 GOSUB21:INPUTGM(PL,11):GOSUB
22:INPUTGM(PL,12):GOSUB23:INPUTG

```

```

M(PL,13)
160 GOSUB24:INPUTGM(PL,14):GOSUB
25:INPUTGM(PL,15):GOSUB26:INPUTG
M(PL,16):GOSUB27:INPUTGM(PL,17)
163 IFNA$(PL+1)=" "THEN165ELSEPL=
PL+1:GOTO110
165 CLS:PRINT"ENTER OPPONENTS GA
ME STATS":GOSUB14:INPUTOG(4):GOS
UB15:INPUTOG(5):GOSUB16:INPUTOG(
6):GOSUB17:INPUTOG(7):GOSUB18:IN
PUTOG(8):GOSUB19:INPUTOG(9):GOSU
B20:INPUTOG(10)
170 GOSUB21:INPUTOG(11):GOSUB22:
INPUTOG(12):GOSUB23:INPUTOG(13):
GOSUB24:INPUTOG(14):GOSUB25:INPU
TOG(15):GOSUB26:INPUTOG(16):GOSU
B27:INPUTOG(17):PRINT"UPDATING S
EASON AND CAREER    STATISTICS
FILES. PLEASE WAIT.";
171 FORY=1TO17:OP(Y)=OF(Y)+OG(Y)
:NEXT
172 FORX=0TO18:FORY=0TO18:CM(X,Y
)=CM(X,Y)+GM(X,Y):CR(X,Y)=CR(X,Y
)+GM(X,Y):NEXT:NEXT:CLS:PRINT@11
,"TEAM STATS":PRINT:INPUT"U OF L
TEAM REBOUNDS";GR(1):INPUT"U OF
L DEADBALL REBOUNDS";GR(2)
175 FORY=1TO17:T0=0:FORX=1TO18:T
0=T0+CM(X,Y):NEXT:CM(0,Y)=T0:NEX

```

# They Driving Force!

## JFD - COCO DISC SYSTEM - \$449

J & M Systems, Ltd. is a leader in the Model III marketplace with our JFD-III Disc Controller. With thousands in operation, we have set new standards in controller performance and reliability. We bring these same high standards to the COCO, resulting in the highest quality disc controller system on the market. Compare these functions before you buy:

- Price. \$449 includes controller, first drive, disc basic in ROM, and manuals. Just plug it in.
- Never needs adjusting. Our exclusive Digital Phase Lock Loop Data Separator and Digital Pre-comp Circuit eliminates the 3 adjustments found on other controllers.
- High quality standard production disc drives. For improved service and reliability, Tandon & Teac drives provide twice the read sensitivity that the drives found in other disc systems do, and hold their alignment far longer.
- Gold-plated card edge connectors throughout.
- Software compatible with Radio Shack Disc Basic, Flex, and OS/9.

J & M Systems, Ltd., 137 Utah NE, Albuquerque, N.M. 87108  
(505) 265-1501

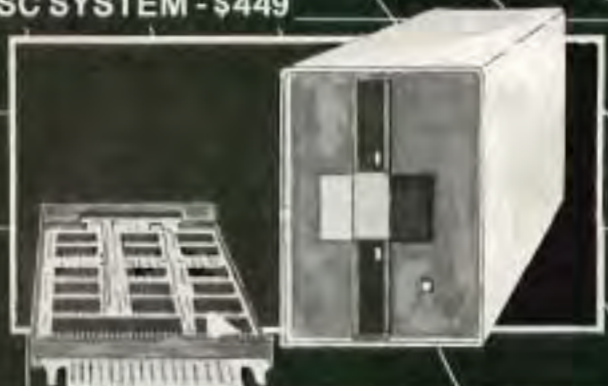

**J&M SYSTEMS, LTD.**

```

T
190 INPUT"OPPONENT TEAM REBOUNDS
";GR(3):INPUT"OPPONENT DEADBALL
REBOUNDS";GR(4):FORX=1TO4:RB(X)=
RB(X)+GR(X):NEXT:RB(5)=RB(5)+1:D
C$=DT$
195 FORPL=1TO18:CM(PL,18)=(CM(PL
,4)*2+CM(PL,6)*3+CM(PL,8))/RB(5)
:NEXT:GOSUB900:GOTO1000
200 CLS:DT$="":PRINT:PRINT:INPUT
"GAME DATE AS MM-DD-YY.
caution- do not use '/' or '.'
which will cause an FN ERROR.
";DT$:GOSUB950
210 CLS:PRINTTAB(8)"PLAYERS IN F
ILE":PA=32:FORX=1TO18:PRINT@PA,U
SING"##";X::PRINT"NA$(X)::PA=P
A+16:NEXT:PA=PA+32:PRINT@PA,"ENT
ER # OF PLAYER TO REVIEW/EDIT"CH
R$(94)"FOR MAIN MENU":INPUTI$:
I=VAL(I$)
215 IFI$=CHR$(94)THENGOSUB900:GO
TO1000ELSEIFI<10RI>18THEN210
220 PL=I:CLS:PRINT@8,"REVIEW PLA
YERS":PRINT@48,NA$(PL)
230 GOSUB30:PRINT:PRINT"ENTRY #
TO CHANGE"CHR$(94)"WHEN DON
E":INPUTI$:IFI$=CHR$(94)THEN210
ELSEI=VAL(I$):IF(I<0OR I>17)THEN2
20
240 CM(PL,I)=CM(PL,I)-GM(PL,I):C
R(PL,I)=CR(PL,I)-GM(PL,I):CM(0,I
)=CM(0,I)-GM(PL,I):CR(0,I)=CR(0,
I)-GM(PL,I)
245 PRINT@416,"":PRINT:PRINT@416
,"ENTER NEW VALUE FOR ENTRY" I:IN
PUTGM(PL,I):CM(PL,I)=CM(PL,I)+GM
(PL,I):CR(PL,I)=CR(PL,I)+GM(PL,I
):CM(0,I)=CM(0,I)+GM(PL,I):CR(0,
I)=CR(0,I)+GM(PL,I):GOTO230
250 PRINT@416,"ENTER NEW VALUE F
OR ENTRY" I:INPUTCR(PL,I):GOTO230
600 'TARGET LINE
605 BF=PEEK(150):BU=INSTR(1,"618
41 87 180",RIGHT$(STR$(BF)
,LEN(STR$(BF))-1)):BU=4800/BU
610 CLS:PRINT@73,"PRINT ROUTINES
",,, "CURRENT BAUD RATE ="BU,
TAB(6)"RESET BAUD RATE",,, "P
RINT STATS TO PRINTER",,, "PR
INT STATS TO DISK",,, "MAIN M
ENU",,, "USE UP/DOWN ARROWS TO M
OVE POINTER TO SELECTION A
ND PRESS enter. ";
611 CT=1
615 CT$=RIGHT$(STR$(CT),1):LP=IN
STR(1," 1 2 3 4",CT$):LP=LP*3
2+2:PRINT@LP,">":GOSUB1:PRINT@L
P,"":IFI$=CHR$(10)ANDCT<4THENC
T=CTT+1:GOTO615ELSEIFI$=CHR$(94)

```

```

ANDCT>1THENCCT=CT-1:GOTO615ELSEIF
I$<>CHR$(13)THEN615ELSEONCT GOTO
620,630,632,1000
620 PRINT" ":INPUT"ENTER NEW BA
UD RATE";BU$:BU$=LEFT$(BU$,1):BL
=INSTR(1,"36124",BU$):IFBL=0THEN
PRINT"baud rate error":SOUND100,
50:GOTO605
625 BU(1)=180:BU(2)=87:BU(3)=41:
BU(4)=18:BU(5)=6:BU=BU(BL):POKE1
50,BU:GOTO605
630 D=-2:GOTO635
632 D=1:OPEN"O",#1,"TYPESET"
635 CLS:IFD=-2THENPRINT#-2,"":PR
INT#-2,CHR$(27)CHR$(20)"Current
"DC$TAB(50)SC$"Basketball Stati
stics"ELSEPRINT#1,"Current"DC$:
PRINT#1,SC$"Basketball Statisti
cs"
636 IFD=-2THENPRINT#-2,CHR$(15)
638 N4$="####":N3$="####":NP$="#.
###":NA$="% %"
640 PL=1:PRINT#D,STRING$(15,32)"
G-GS MIN-AVG FG-FGA P
CT FT-FTA PCT REB-AVG AS
ST-AVG PF-D STL BLK TOVR
DUNK TP - AVG":IFD=-2THENPRINT
#-2,CHR$(14)
642 IFNA$(PL)=""THEN682
644 PRINT#D,"":PRINT#D,USINGNA$:
NA$(PL)::PRINT#D,USING"###":CM(P
L,1)::PRINT#D,"-":PRINT#D,USING
N3$:CM(PL,2)::PRINT#D,"":PRIN
T#D,USINGN4$:CM(PL,3)::PRINT#D,"
-";
646 IFCM(PL,1)>0THENPRINT#D,USIN
G"###.#":CM(PL,3)/CM(PL,1):ELSEPR
INT#D,USING"###.#":0;
648 PRINT#D,"":PRINT#D,USINGN
3$:CM(PL,4)::PRINT#D,"-":PRINT#
D,USINGN3$:CM(PL,5)::PRINT#D,"
":IFCM(PL,5)>0THENPRINT#D,USING
NP$:CM(PL,4)/CM(PL,5):ELSEPRINT#
D,USINGNP$:0;
650 PRINT#D,"":PRINT#D,USINGN
3$:CM(PL,8)::PRINT#D,"-":PRINT#
D,USINGN3$:CM(PL,9)::PRINT#D,"
":IFCM(PL,9)>0THENPRINT#D,USING
NP$:CM(PL,8)/CM(PL,9):ELSEPRINT#
D,USINGNP$:0;
652 PRINT#D,"":PRINT#D,USINGN
4$:CM(PL,10)::PRINT#D,"-":IFCM(
PL,10)>0THENPRINT#D,USING"###.#":CM
(PL,10)/CM(PL,1):ELSEPRINT#D,USI
NG"###.#":0;
654 PRINT#D,"":PRINT#D,USINGN
4$:CM(PL,11)::PRINT#D,"-":IFCM(
PL,11)>0THENPRINT#D,USING"###.#":CM
(PL,11)/CM(PL,1):ELSEPRINT#D,USI
NG"###.#":0;

```

```

656 PRINT#D, " ";:PRINT#D,USINGN
4$;CM(PL,12);:PRINT#D,"-";:PRINT
#D,USING"#";CM(PL,13);:PRINT#D,"
";:PRINT#D,USINGN3$;CM(PL,14);
658 PRINT#D, " ";:PRINT#D,USINGN
3$;CM(PL,15);:PRINT#D," ";:PRIN
T#D,USINGN3$;CM(PL,16);:PRINT#D,
" ";:PRINT#D,USINGN3$;CM(PL,17)
;
659 PRINT#D, " ";:TP=2*CM(PL,4)
+3*CM(PL,6)+CM(PL,8):PRINT#D,USI
NGN4$;TP;:PRINT#D," - ";:IFCM(PL
,1)>0THENPRINT#D,USING"##.#";TP/
CM(PL,1)ELSEPRINT#D,USING"##.#";
0
660 IFCM(PL,1)=CR(PL,1)THENPL=PL
+1:GOTO642
662 PRINT#D,USINGNA$;" Career"
;:PRINT#D,USING"###";CR(PL,1);:P
RINT#D,"-";:PRINT#D,USINGN3$;CR(
PL,2);:PRINT#D," ";:PRINT#D,USI
NGN4$;CR(PL,3);:PRINT#D,"-";:PRI
NT#D,USING"##.#";CR(PL,3)/CR(PL,
1);
664 PRINT#D, " ";:PRINT#D,USINGN
3$;CR(PL,4);:PRINT#D,"-";:PRINT#
D,USINGN3$;CR(PL,5);:PRINT#D,"
";:PRINT#D,USINGNP$;CR(PL,4)/CR(
PL,5);
666 PRINT#D, " ";:PRINT#D,USINGN
3$;CR(PL,8);:PRINT#D,"-";:PRINT#
D,USINGN3$;CR(PL,9);:PRINT#D,"
";:PRINT#D,USINGNP$;CR(PL,8)/CR(
PL,9);
668 PRINT#D, " ";:PRINT#D,USINGN
4$;CR(PL,10);:PRINT#D,"-";:PRINT
#D,USING"##.#";CR(PL,10)/CR(PL,1)
;:PRINT#D," ";:PRINT#D,USINGN4$
;CR(PL,11);:PRINT#D,"-";:PRINT#D
,USING"##.#";CR(PL,11)/CR(PL,1);
669 PRINT#D, " ";:PRINT#D,USINGN
4$;CR(PL,12);:PRINT#D,"-";:PRINT
#D,USING"#";CR(PL,13);:
671 PRINT#D, " ";:PRINT#D,USINGN
3$;CR(PL,14);:PRINT#D," ";:PRIN
T#D,USINGN3$;CR(PL,15);:PRINT#D,
" ";:PRINT#D,USINGN3$;CR(PL,16)
;:PRINT#D," ";:PRINT#D,USINGN3$
;CR(PL,17);
673 PRINT#D, " ";:TP=2*CR(PL,4)
+3*CR(PL,6)+CR(PL,8):PRINT#D,USI
NGN4$;TP;:PRINT#D," - ";:PRINT#D
,USING"##.#";TP/CR(PL,1)
674 PL=PL+1:GOTO642
682 PRINT#D,USINGNA$;" ";:PRINT#D
,CHR$(15)STRING$(111,32)CHR$(14)
:SD$=SC$+" TOTALS":PRINT#D,USING
NA$;SD$;:PRINT#D,STRING$(18,32);
684 PRINT#D, " ";:PRINT#D,USINGN
3$;CM(0,4);:PRINT#D,"-";:PRINT#D

```

```

,USINGN3$;CM(0,5);:PRINT#D," ";
:PRINT#D,USINGNP$;CM(0,4)/CM(0,5
);ELSEPRINT#D,USINGNP$;0;
686 PRINT#D, " ";:PRINT#D,USINGN
3$;CM(0,8);:PRINT#D,"-";:PRINT#D
,USINGN3$;CM(0,9);:PRINT#D," ";
:PRINT#D,USINGNP$;CM(0,8)/CM(0,9
);:PRINT#D," ";:PRINT#D,USINGN4
$;CM(0,10)+RB(1);:PRINT#D,"-";:P
RINT#D,USING"##.#";(CM(0,10)+RB(
1))/RB(5);
688 PRINT#D, " ";:PRINT#D,USINGN4
$;CM(0,11);:PRINT#D,"-";:PRINT#D
,USING"##.#";CM(0,11)/RB(5);:PRI
NT#D," ";:PRINT#D,USINGN4$;CM(0,
12);:PRINT#D,"-";:PRINT#D,USING"
##.#";CM(0,13);:PRINT#D," ";:PRINT
#D,USINGN3$;CM(0,14);
690 PRINT#D, " ";:PRINT#D,USINGN
3$;CM(0,15);:PRINT#D," ";:PRINT
#D,USINGN3$;CM(0,16);:PRINT#D,"
";:PRINT#D,USINGN3$;CM(0,17);:P
RINT#D," ";:TP=2*CM(0,4)+3*CM(
0,6)+CM(0,8):PRINT#D,USINGN4$;TP
;:PRINT#D," - ";:PRINT#D,USING"#
##.#";TP/RB(5)
692 PRINT#D,"":PRINT#D,"Opponent
's Totals"STRING$(16,32);
694 PRINT#D, " ";:PRINT#D,USINGN
3$;OP(4);:PRINT#D,"-";:PRINT#D,U
SINGN3$;OP(5);:PRINT#D," ";:PRI
NT#D,USINGNP$;OP(4)/OP(5);ELSEPR
INT#D,USINGNP$;0;
696 PRINT#D, " ";:PRINT#D,USINGN
3$;OP(8);:PRINT#D,"-";:PRINT#D,U
SINGN3$;OP(9);:PRINT#D," ";:PRI
NT#D,USINGNP$;OP(8)/OP(9);:PRINT
#D," ";:PRINT#D,USINGN4$;OP(10)
;:PRINT#D,"-";:PRINT#D,USING"##.
#";OP(10)/RB(5);
698 PRINT#D, " ";:PRINT#D,USINGN4
$;OP(11);:PRINT#D,"-";:PRINT#D,U
SING"##.#";OP(11)/RB(1);:PRINT#D
," ";:PRINT#D,USINGN4$;OP(12);:P
RINT#D,"-";:PRINT#D,USING"#";OP(
13);:PRINT#D," ";:PRINT#D,USING
N3$;OP(14);
700 PRINT#D, " ";:PRINT#D,USINGN
3$;OP(15);:PRINT#D," ";:PRINT#D
,USINGN3$;OP(16);:PRINT#D," ";:
PRINT#D,USINGN3$;OP(17);:PRINT#D
," ";:TP=2*OP(4)+3*OP(6)+OP(8)
;:PRINT#D,USINGN4$;TP;:PRINT#D,"
- ";:PRINT#D,USING"##.#";TP/RB(5
)
702 PRINT#D,"":PRINT#D,SC$" TEAM
REBOUNDS"TAB(30)RB(1)"-";:PRINT
#D,USING"##.#";RB(1)/RB(5);:PRINT
#D,TAB(50)"Opponent Team Rebound
s:"TAB(80)RB(2)"-";:PRINT#D,USIN

```

```

G".#" ; RB(2)/RB(5)
703 PRINT#D, SC$ " DEADBALL REBOUN
DS" TAB(30) RB(3) "-" ; : PRINT#D, USIN
G".#" ; RB(3)/RB(5) ; : PRINT#D, TAB(
50) "Opponent Deadball Rebounds:"
TAB(80) RB(4) "-" ; : PRINT#D, USING"#
.#" ; RB(4)/RB(5)
704 PL=1:PRINT#D, "" : PRINT#D, "3 P
oint FG-FGA: ";
706 IFNA$(PL)=" " THEN 720
708 IFCM(PL,7) > THEN PRINT#D, NA$(
PL) (" ; : PRINT#D, USING"#" ; CM(PL,
6) ; : PRINT#D, "-" ; : PRINT#D, USINGN
#" ; CM(PL,7) ; : PRINT#D, ", " ; : PL=PL
+1:GOTO706
720 PRINT#D, "" : CLOSE:GOTO1000
800 CLS:PRINT@162, "sorting":PL=1
:FORX=0TO18:FORY=0TO18:TM(X,Y)=0
:TR(X,Y)=0:NEXT:OD(X)=X:NEXT:CT=
0
810 IFNA$(PL+1)=" " THEN IFFL=1 THEN
PL=1:FL=0:CT=CT+1:PRINT@183, "PAS
S "CT:GOTO810 ELSE 840
820 IFCM(PL,18)=>CM(PL+1,18) THEN
PL=PL+1:GOTO810
825 FORX=1TO18:PRINTCM(X,18) ; : NE
XT
830 FL=1:TP$=NA$(PL):NA$(PL)=NA$(
PL+1):NA$(PL+1)=TP$:TP=OD(PL):O
D(PL)=OD(PL+1):OD(PL+1)=TP:TP=CM
(PL,18):CM(PL,18)=CM(PL+1,18):CM
(PL+1,18)=TP:PL=PL+1:GOTO810
840 FORX=0TO18:FORY=0TO17:TM(X,Y
)=CM(OD(X),Y):TR(X,Y)=CR(OD(X),Y
):NEXT:NEXT:FORX=0TO18:FORY=0TO1
7:CM(X,Y)=TM(X,Y):CR(X,Y)=TR(X,Y
):NEXT:NEXT:GOTO1000
900 CLS:PRINT:PRINT"SAVE TO 1 TA
PE OR 2 DISK":GOSUB1:IFI<1ORI>2T
HEN900
910 D=1:IFI=1THEND=-1:GOSUB35
920 OPEN"O",#D,"CURRSTAT":PRINT#
D,DC$:PRINT#D,SC$:FORK=0TO18:PRI
NT#D,NA$(K):FORL=0TO18:PRINT#D,C
R(K,L):PRINT#D,CM(K,L):NEXT:PRIN
T#D,OP(K):NEXT:FORK=1TO5:PRINT#D
, RB(K):NEXT:CLOSE
930 IFDT$<>" " THEN OPEN"O",#D,DT$:
PRINT#D,OP$:PRINT#D,DT$:FORK=1TO
18:FORL=1TO18:PRINT#D,GM(K,L):NE
XT:PRINT#D,OG(K):NEXT:FORK=1TO4:
PRINT#D,GR(K):NEXT:CLOSE
940 IFI=1THEN I=0:MOTORON:FORK=1T
O600:NEXT:GOTO920 ELSE RETURN
950 CLS:PRINT:PRINT"LOAD FROM 1
TAPE OR 2 DISK":GOSUB1:IFI<1ORI>
2THEN950
960 D=1:IFI=1THEND=-1
970 OPEN"I",#D,"CURRSTAT":INPUT#
D,DC$:INPUT#D,SC$:FORK=0TO18:INP

```

```

UT#D,NA$(K):FORL=0TO18:INPUT#D,C
R(K,L):INPUT#D,CM(K,L):NEXT:INPU
T#D,OP(K):NEXT:FORK=1TO5:INPUT#D
, RB(K):NEXT:CLOSE
980 IFDT$<>" " THEN OPEN"I",#D,DT$:
INPUT#D,OP$:INPUT#D,DT$:FORK=1TO
18:FORL=1TO18:INPUT#D,GM(K,L):NE
XT:INPUT#D,OG(K):NEXT:FORK=1TO4:
INPUT#D,GR(K):NEXT:CLOSE
990 RETURN
1000 CLS:PRINT@42,"MAIN MENU":PR
INT:PRINT" 1 ENTER NEW GAME STAT
ISTICS":PRINT:PRINT" 2 EDIT/CORR
ECT CURRENT GAME FILE":PRI
NT:PRINT" 3 EDIT/CORRECT PREVIUO
S GAME FILE"
1002 PRINT:PRINT" 4 PRINT STATIS
TICS":PRINT:PRINT" 5 SORT ON AVE
RAGE"
1010 GOSUB1:ONI GOTO100,210,200,
600,800:GOTO1000
1020 PL=1
1030 IFNA$(PL)=" " THEN 110 ELSE PL=P
L+1:GOTO1030
2000 CLEAR1000:DIMNA$(18),CR(18,
18),CM(18,18),GM(18,18),OG(18),O
P(18),GR(4),RB(5),OD(18),TM(18,1
8),TR(18,18):FT$="% %":GOT
O1000
2010 PCLEAR1:GOTO2000

```

## About Your Subscription

Your copy of *the Rainbow* is sent second class mail and, for subscribers in the United States, the date of mailing is printed on the label. If you do not receive your copy by the 25th of any month, send us a card and we will mail another immediately via first class mail.

You must notify us of a new address when you move. Notification should reach us no later than the 15th of the month prior to the month in which you change your address. Sorry, we cannot be responsible for sending another copy when you fail to notify us.

Your mailing label also shows an "account number" and the subscription expiration date. Please indicate this account number when renewing or corresponding with us. It will help us help you better and faster.

For Canadian and other non-U.S. subscribers, there may be a mailing address shown that is different from our editorial office address. Do not send any correspondence to that mailing address. Send it to our editorial offices at P.O. Box 209, Prospect, KY 40059. This applies to everyone *except* those whose subscriptions are through our distributor in Australia.

# What's Bothering You About BASIC?

By Richard A. White  
Rainbow Contributing Editor

I occasionally stew over what to write about next. A friend agreed that I have touched many of the principal basics. And then something comes up and an idea is born. Well, this month's article got just such a start and was well underway when some mail came from *the Rainbow* and I decided to save what had been written for later and start fresh. The writers asked some real basic questions that need answering and we will do that in this issue. What's bothering you about BASIC? Drop me a short note through *the Rainbow* and I may be able to answer your question as well.

Judith Almandariz from Illinois writes as follows. "I am a novice with computers . . . I find myself extremely frustrated each time people allude to *PEEK* and *POKE* statements. I can't find any books which adequately describe what exactly you are doing when you *PEEK* and *POKE*. Where do your contributing authors find the information as to what to *PEEK* or *POKE* into their programs to obtain the desired results?" Well, Judith, you need to understand how computers work to really understand what *PEEK* and *POKE* do. You are not alone, there are a whole lot of new computer owners struggling to understand their machines. Indeed, why buy a computer and study BASIC if not to learn how computers work and how to use them? Computer literacy comes only from much study and work. So, let's start the lesson.

A computer starts with memory. Memory consists of electronic circuits that can either be off or on. Each circuit is a "bit." If the circuit is on, the bit equals one, else it is a zero. You will also see the ON state represented as high (voltage) and OFF as low (voltage). In any case, only two states can exist. This is what binary means, two states.

These individual circuits, or bits, are grouped in blocks of eight which make up a byte. A byte is always eight bits. Bits in a byte can be set to define any number between 0 and 255 decimal. For example the byte "00000000" means zero. The byte "11111111" means 255. CoCo's memory is divided into byte-sized memory locations.

There are two types of memory. Read Only Memory,

ROM, is made so the numbers are permanently fixed in the chip. You can turn the computer off and back on and the information in the ROM is always there for the microprocessor to use. Random Access Memory, RAM, is changeable. The microprocessor can put numbers into RAM locations as well as reading the numbers that are there. Further, RAM numbers exist only while the power is on. Turn the power off and all voltages in the RAM go to zero, destroying any stored data.

Our microprocessor does all its work by reading instruction and data numbers from memory and performing the action which the instruction numbers call for. Data numbers can mean many things depending on the program. These can include data addresses in memory, calculated numbers or numeric representations of characters.

Now a *PEEK* statement does nothing more than look at a memory location and return in decimal form the number contained in the byte stored there. Type in *PRINT PEEK (150)*. If you just started up your machine, an 87 will appear on your screen. You told CoCo to print the value stored in memory location 150. What does an 87 in memory location 150 mean to CoCo? When CoCo goes to send data to the printer, it needs to know the Baud rate or how fast to send. A routine in BASIC manages this transmission. It instructs the microprocessor to get the number in location 150 and use that number to determine how long each bit sent the printer should be.

*POKE* allows you to put a number ranging from 0 to 255 into a memory location. If your printer is set up for 1200 Baud, the number in location 150 should be 41. You need to set that with the statement *POKE 150,41*. *PEEK* and *POKE* can work with all the 65535 bytes that the microprocessor can address. What happens depends on what kind of memory or register is at the location addressed. *PEEK* will return a valid number from any address where there is ROM or RAM memory installed. It will even return numbers from *PEEKs* to addresses where there is no RAM. These are meaningless. A *POKE* to a RAM address will put the number into that address. Nothing happens when a number is *POKEd* to a ROM address or to an address where no memory is installed.

Where do you find what to *POKE*? The *POKE150,41* comes right out of the Color BASIC manual. Spectral Asso-

---

(Richard White has a long background with microcomputers and specializes in BASIC programming. With Don Dollberg, he is the author of the TIMS data base management program.)

# The best in software for kids!



## THE MONEY SERIES BY STEVE BLYN

**DOLLARS & SENSE 16K ECB \$14.95**  
Player buys familiar items using dollars and coins to practice using money correctly.

**McGOGO'S MENU 16K ECB \$14.95**  
Learn to buy and add up your purchases from a typical fast-food restaurant menu.

**MONEY-PAK 32K ECB \$22.95**  
A combined and menu driven version of the above programs. Includes play money. Reviewed - Rainbow 7/83

**COLORGRADE 32K ECB \$29.95**  
A great aid to teachers. Records and calculates grades for up to 6 classes of up to 40 students each. Uses number or letter grades, named or numerical periods and gives a weighted average. Easy to use. Full directions. DISK ONLY. By David Lengyel.

## BEYOND WORDS 32K ECB \$19.95 Each

These Language Arts programs cover common misspellings, and synonyms/antonyms on each level. Additionally, Level 1 tests contractions and abbreviations, Level 2 tests homonyms, and Level 3 tests analogies. Each program has 3 parts and contains over 400 questions and uses over 800 words. All tests are grade appropriate. User modifiable (directions included). Printer option.

Level 1 Grades 3-5  
Level 2 Grades 6-8  
Level 3 Grades 9-12

DISK VERSION Each \$23.95

## New

### MATH INVADERS by David Steele 16K EB. \$17.95

A multi-level 'Space Invaders' type game to reinforce the 4 basic math operations (addition, subtraction, multiplication and division). Problems become more difficult as you progress. Hi-res. graphics, joystick required.

**THE MATH TUTOR SERIES 16K Ext.**  
These tutorials take the child through each step of the example. All programs include HELP tables, cursor and graphic aids. All allow user to create the example, or let the computer choose. Multi-level. Great teaching programs. By Ed Guy.

LONG DIVISION TUTOR \$14.95  
MULTIPLICATION TUTOR \$14.95  
FACTORS TUTOR \$19.95  
FRACTIONS TUTOR (Addition) \$19.95  
FRACTIONS TUTOR (Subtraction) \$19.95  
FRACTIONS TUTOR (Multiplication) \$19.95  
Any 2 FRACTIONS programs \$29.95

**GRAPH TUTOR 32K ECB \$19.95**  
Line, bar, pie and pictographs are demonstrated. Learn to read and use these graphs. Test mode, Hi-res graphics throughout. By Chris Phillips.

**THE HISTORY GAME 32K ECB \$14.95**  
"Jeopardy" type game by James Keeling. 5 categories and 5 questions in each category. One or two player game checks your knowledge of American History. Different questions each round. Hi-res graphics.

## FUN and GAMES

(ALL PROGRAMS IN 16-K EXTENDED EXCEPT WHERE NOTED)

- CIRCUS ADVENTURE**-by Steve Blyn 16K-Kids adventure game. \$11.95  
**SCHOOL MAZE** - by Steve Blyn 16K - Kids graphic adventure. \$11.95  
**HAMSTER HUNT** - by L&D Weston 32K - Beautiful graphics in this charming new kids adventure game. \$19.95  
**MR. COCOHEAD** - by Steve Blyn - Create over 10,000 funny faces. Surprise commands. Very creative. \$16.95  
**TALKING WIZARD** - voice by Classical Computing - Child-sized Eliza-Freud game. Computer speaks to you. \$19.95  
**PICNIC/TRICKASHAY** - 2 Hi-res. ML arcade games for all ages. \$11.95  
**FUNPAK FOR SPECTRUM'S LIGHTPEN**-3 exciting kid's games. \$11.95  
\* SPECIAL \* LIGHTPEN and FUNPAK \$29.95  
**HORSERACE** - by R&P Armstrong - Hi-res. race for all ages. \$11.95  
**COCOJOT** - by S.Greenberg - Multilevel Jotto. Ages 8-adult. \$11.95  
**NAME THAT SONG I** - 72 kid's songs to guess. \$11.95  
**NAME THAT SONG II** - 72 adult hits from the past 30 years. \$11.95  
**HEBREW ALPHABET** - Learn the letters of this alphabet. \$11.95  
\*\* A BYTE OF COLOR BASIC - Beginner's manual & exercises \$ 4.95

## MORE LEARNINGWARE

(ALL PROGRAMS IN 16-K EXTENDED EXCEPT WHERE NOTED)

- CONTEXT CLUES** - by Steve Blyn - Multiple choice reading programs. Specify grade 4,5,6 or 7. each \$17.95  
**VOCABULARY BUILDERS** - 32K - Great for test preparations. 200 questions, multiple choice, modifiable, printer option. I (grades 3-5), II (6-8) or III (9-12) each \$19.95  
**READING AIDS 4-PAK** - Child creates own reading material. \$19.95  
**GRAPH-IT** - by D.Steele - Graph sets of algebraic equations. \$14.95  
**KNOW YOUR STATES**-32K-by J.Keeling-Name all hi-res. states \$19.95  
**MUSIC DRILL** - by D.Steele - Identify notes of many scales. \$19.95  
**FRENCH OR SPANISH BASEBALL** - By S. Blyn each \$11.95  
Vocabulary practice. 200 words. Modifiable. Specify language. \$19.95  
**PRE-SCHOOL SERIES** - By J. Kolar. each \$11.95  
Pre. 1-Counting, number recognition; Pre. 2 - Simple Addition; Pre. 3 - Alphabet Recognition.  
**HEBREW BULLETIN BOARD**-by J.Kolar-utility to print words. \$15.95  
Ed. Programs For  
**TALKING MATH DRILL** 3 for \$24.95  
**TALKING SPELLING TESTER** \$9.95 each  
**TALKING FOREIGN LANGUAGES**



Dealers inquiries invited.



\*\*\*\*Rating Radio Shack  
Educational Software Support  
Group

(212) 948-2748

Dept. R 227 Hampton Green, Staten Island, N.Y. 10312

Send for catalog with complete descriptions.

Please add \$1.00 per order for postage. N.Y. residents, please add proper tax. FREE set of BINARY DICE, including full directions, with orders of 2 or more items  
Authors: We are seeking quality children's software for leisure or learning. Write for details. Top Royalties.

TRS-80 Color Computer. TDPSystem 100.



# PIPELINE

**THE STORIES ABOUND** that there will be yet another Color Computer, or at least, another version of the CoCo within several months. We hear that from a number of places, but we also hear that the chances of any major modifications are not really very likely in the near future. Part of the rumors, obviously, are "scrambled" from word that leaked out on the new Tandy TRS-80 2000 — a "color computer" in that it has high resolution graphics and colors available. But this new computer from Tandy — a very sophisticated machine, by the way — is aimed at a very different market. With the rumors flying, it was easy to see how some things might have gotten a bit mixed up. Yes, we do see some changes in CoCo, but the chances are that, at least for the moment, those changes will be ones that will evolve in steps rather than by dramatic leaps.

Speaking of the Tandy 2000, it is an excellent machine which out IBM's IBM. Comments at the recent COMDEX show where it was unveiled were almost 100 percent enthusiastic. In fact, the 2000 may well be *the* state of the art personal business computer of the year. It is certainly a brighter contender for the honors than the new IBM entry, the PCjr., or "Peanut," which also was at the show last month.

\*\*\*

**ONE OF THE HOTTEST** buzzwords in the computer software field these days is "Windows," with the leader obviously being Microsoft, which has a program by that specific name. What a window is is a program which allows you to put several different "screens" from several different programs on the monitor at the same time. What with the Hi-Res capabilities of the CoCo, we would not be surprised to see some "Window" programs being offered for this market before very long. One of the things, though, that we thought landed in the "missed the boat" area as far as Microsoft's promotion was concerned was failure to recognize an opportunity to coin an old saying in selling their Windows program: "We *do* do Windows."

**YOU DON'T OFTEN READ** news about other Color Computer publications on these pages, simply because we do not make it our business to comment on anything which might be considered to be partisan in nature. But we have received a number of letters on the subject and we feel it only fair that you know that it is out understanding that *Color Computer News* is ceasing publication and that *Hot CoCo* has agreed to fulfill the outstanding *CCN* subscriptions. From what we hear, that means *CCN* subscribers will get issues of *Hot CoCo* until their *CCN* subscriptions run out.

\*\*\*

**MARKETING THESE** wonderful machines we use in our work and play is at the heart of industry health, and so when we found a recent Radio Shack news release announcing the promotion of Ron G. Stegall to senior vice president, computer marketing, we very carefully penciled "Pipeline" at the top of the page. We're pleased to recognize this step up for Ron to a position so closely related to the health and well-being of all of us. In his new capacity, Ron will be responsible for the overall marketing effort of the more than 400 Radio Shack Computer Centers and more than 630 Radio Shack Computer Departments nationwide, as well as other account, education and procurement duties.

And while we're speaking of new Radio Shack vice presidents, we should mention William D. Gattis's new appointment to the position of vice president, Radio Shack Education Division. He will be responsible for the development and overall marketing of micro-computer products, instructional software and courseware systems for educational applications. Congratulations to both of these gentlemen, and our thanks for the job they have done for the Color Computer and the industry.

\*\*\*

**WEST COAST ROCK** fans are developing modemanias, it seems, as Portland rock station KGON 92FM has begun operating a new BBS for hard-rock hackers, or "user-listeners" as the station says.

The KGON BBS will initially consist of a dozen menu options including not only the top 40 rock songs in the Portland area, but the top 10 software sales and the top 20 videocassette rentals. News, rock news and concert reviews, as well as an E-mail service, will also be available to those calling KGON's data line at (503) 655-9181. And what would the West Coast be without its preoccupation with lifestyle? Well, it would still be beautiful, but nevertheless, lifestyle information is yours for the dialing, too.

The operational hours for KGON BBS are from 6 p.m. to 6 a.m. Monday through Friday, and around the clock on weekends and holidays. Sysop Chris Burns, who is also KGON's news director, informs us that calls are limited to 15 minutes. The system is comprised of a 64K Color Computer, two Radio Shack disk drives, and a Hayes Smartmodem 300. Give 'em a call. Long live Hack N' Roll!

\*\*\*

**THAR'S GOLD** in them thar controller modules, says the E.A.P. Company of Keller, Texas, but don't rush 'em off to your local assayer; instead, plug 'em into your ROM port and eliminate the problems of poor contact that often cause such things as directory errors and inaccessible data. We're speaking of a disk module kit called Gold Plug-80.

Ground tab extensions are included in the kit which extend the ground tabs far enough to contact the ground clips on the CoCo female connector, reducing RFI.

E.A.P. Company sells various versions of the Gold Plug-80 for between \$10 and \$20. They also have gold-plated drive cables. Write them at P.O. Box 14. Their zip is 76248.

\*\*\*

**RENDERING UNTO SEIZURE** by the IRS that portion of your annual earnings we call taxes can be less taxing, at least on your time and disposition, if you use the new CoCo Taxpreparer by Micro Data Systems. Besides handling the calculations you'll need for a finished return, this program will provide printer outputs directly on government approved forms and schedules using pin feed or tractor feed printers. CoCo Taxpreparer requires 32K Extended BASIC and a disk drive. It costs \$149.95 and you can contact the company at 6 Edward Drive, Ashland, Mass., 01721.



# It's here!



**The Rainbow Book of Adventures** is in stock and ready for immediate delivery. This 112-page special edition contains top contest winners and a dozen more selected Adventures, ready for you to type in and run.

If you're just getting started in Adventures, here's a collection of 14 Adventure games ready to test your wits.

If you're considering entering your own Adventure creation in *the Rainbow's* Adventure contest, **The Rainbow Book of Adventures** is a must to see how the last year's top contestants became winners. All of the award winners in *the Rainbow's* first Adventure contest have their entries reproduced in their entirety in **The Rainbow Book of Adventures** — plus there are hints to authors and comments from the chief judge of last year's contest to help you hit the ground running in this year's Adventure writing competition.

**The Rainbow Book of Adventures** is just \$7.95.



Please send \_\_\_\_\_ copies of **The Rainbow Book of Adventures** @ \$7.95 each.

Name (please print) \_\_\_\_\_

Street Address \_\_\_\_\_

City & State \_\_\_\_\_ ZIP \_\_\_\_\_

## **SPECTRUM PROJECTS**

93-15 86th DRIVE  
P.O. Box 21272  
WOODHAVEN, N.Y. 11421

## **CALL 212-441-2807**

ALL ORDERS PLUS \$3.00 S/H  
N.Y. RESIDENTS ADD SALES TAX





# SPECTRUM PROJECTS

## SOFT AND HARD WARES FOR COLORFUL COMPUTING



### COMMUNICATION

### WORD PROCESSING

**COLORCOM/E** - A complete smart terminal package! Upload, Download, Hi-Res (51X24) screen, 300/1200 Baud, Offline Printing and much more. Rompak or Disk - \$49.95



**TELEWRITER-64** - Top CoCo Word Processor for 2 years! Three Hi-Res screens, true lowercase characters, right justification, full screen editor. Tape \$49.95 Disk \$59.95

### MODEMS

### PRINTERS

**MINI-MODEM** - 300 Baud, Originate/Answer, Full Duplex, Direct Connect - \$79.95  
**HAYES SMART MODEM** - Auto Dial, Auto Answer - \$249.95  
 Prices include Modem cable.



**GEMINI 10X** - 120 cps, 9X9 dot matrix - \$299.95  
**DYNAX** - Daisy wheel with letter quality print - \$499.95  
**BOTEK INTERFACE** - Save \$20! Needed for printers - \$49.95

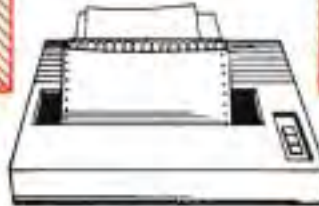

### KEYBOARDS

### MONITORS

**PROFESSIONAL**(Micronix) \$59.95\*  
**SUPER-PRO** (Mark Data) \$69.95  
**HJLS7 Keyboard** - \$79.95\*  
 \* - Includes free software for 4 function keys. Specify Model /Revision Board.



**GORILLA** - Hi-Res (22mhz), 80X24 screen monitors :  
 Green- \$99.95 Amber- \$119.95  
**AMDEK Color Monitor** - \$299.95  
**VIDEO PLUS** - video interface for above monitors - \$24.95

*Buy any Modem and  
Save \$10 off Colorcom/E*

*Buy any Printer,  
Keyboard or Monitor and  
Save \$10 off Telewriter-64*



# SPECTRUM PROJECTS

## SOFT AND HARD WARES FOR COLORFUL COMPUTING



### SPREADSHEET

ELITE CALC - 255 Rows, 255 Columns, Help Displays, Repeat Text Entries, Insert, Delete, Move Entire Rows, Selectable Auto Cursor Movement, Formulas 255 chars. Disk/Tape \$59.95

### DATA BASE MANAGER

PRO-COLOR FILE - 60 Data Fields, 8 Report Formats, 1020 bytes/record, Sorts 3 Fields, Screen and Summary Reports, Duplicate Records and Fields, Page Titles - Disk \$79.95



**Buy 'em  
both for  
\$99.95**

**Save \$40 !**

### DISK DRIVES

DRIVE 0 System - 40 trks, Gold Platted Connectors - \$349.95  
 AMDEK System - 624K Bytes with 3" Disk Cartridge - \$599.00  
 DISK CONTROLLER - \$139.95 (Systems include controller)

### GAME CONTROLLERS

WICO Command Adaptor - Hookup 2 Atari type joysticks- \$19.95  
 With 2 Atari joysticks- \$39.95  
 WICO Analog Joystick - Self Centering and Free Floating !!  
 Red arcade size handle- \$49.95



### UTILITIES (DISK)

1. 64K Screen Expander . \$27.95  
 2. Disk Doctor .....\$39.95  
 3. Super Forth .....\$39.95  
 4. Basic Aid .....\$49.95  
 5. OS-9 .....\$69.95  
 6. FHL Flex .....\$69.95

### GAMES (TAPE)

1. Cubix .....\$24.95  
 2. The King .....\$26.95  
 3. Guardian .....\$27.95  
 4. Junior's Revenge ....\$28.95  
 5. Colorpede .....\$29.95  
 6. Zaxxon .....\$34.95

**Buy     Save**

**2       10%**

**3       15%**

**4       20%**



**Add \$3.00 S/H**  
**NY Res Add Tax**

**Order Line**  
**212-441-2807**

**Spectrum Projects**  
**93-15 86th Drive**  
**PO Box 21272, Woodhaven, NY 11421**

ciates' book, "The Facts" is full of memory locations and their contents. Bob Russell's "Color Computer" Memory Map appeared in four installments in the 1983 issues of *the Rainbow* and may be ordered for \$9 (Bob Russell, 5474 Stillwater Court, Fredonia, Wis. 53021). These are good references, but to know that the cursor color is stored at a certain location doesn't help much if you are not interested in changing the cursor.

A better way is to follow the programming articles and hints in *the Rainbow* and see where authors are *PEEKing*, *POKEing*, why they are doing it and what kind of results are obtained. *PEEKs* and *POKEs* are not as important to CoCo as they are to competing machines. For example, we have BASIC commands for graphics while Apple, Commodore and Atari need to *POKE* numbers to get similar results. And why remember to *POKE 65313,4* to turn the cassette motor on when the BASIC command *MOTORON* does the same thing easier? Oh, you just had to try it, did you, and now *MOTOROFF* won't turn the cassette off? *POKE 65313,52*.

I hope that helps, Judith. You even got the tutorial you wanted.

---

---

**"Note that in all of this, that the guiding principle is what makes it easiest for you, the programmer."**

---

---

F. Bruhns from California asked for an article on the ins and outs of multiple statements under the same line number including what works and what does not. A well stated request, so here goes. Line numbers are used by BASIC to define the start of a block of code. They are particularly important in defining the targets for *GOTOs* and *GOSUBs* and line calls after *THEN*. A line number may be thought of as an address. Think of two houses, one where a single person lives and one where there is a big family complete with grandparents. The mailman delivers mail to a single mailbox in each case. It generally does not matter how many live in the house. In BASIC this is true as well in that one or many statements may be on a line.

Now should the grandparents have a separate entry and part of the big house and wish to get their mail directly, they would put up their own mailbox and have a separate address. We would put them under a different line number so their mail can *GOTO* them directly. So, subroutines and code blocks that are targets of *GOTOs* elsewhere in the program start with separate line numbers.

Just as many people can live in a house, many statements can be under a single line number. Each is separated by a colon (:). The limit is the number of characters the keyboard buffer will accept. I count 249 characters. You can stuff even more if you use a program like Eigen's *Stripper* which combines lines of tokenized BASIC.

After you enter a line, it goes through a tokenizing process that converts all keywords like *PRINT*, *POKE*, *INPUT* etc., to one or two numbers unique to each. Obviously, fewer bytes are needed to store the tokenized line of code, and *Stripper* simply combines tokenized lines within certain

rules to fill out to 250 bytes capacity. Five more bytes are used for the line number, the address of the next line in memory and the 0 at the end of the line.

One rule is that a line called by a *GOTO* or a *GOSUB* is not added to the line above it. Another is that a following line cannot be added to the line above when the first line ends with an *IF/THEN* statement. *IF/THEN* is a control structure that is managing program action. One action can be to fall to the line below if the test made after *IF* is untrue. Obviously that could not happen if the statements in line below were instead after the *THEN*. So think out what is happening after *IF/THEN* statements. And while we are on *IF/THEN/ELSE*, no colon is used after *IF* or on either side of *THEN* or *ELSE*.

In some instances quite a bit of code is needed after *THEN* and *ELSE* to get all the work done that is needed. Resist the temptation to keep the line short by putting the statements in the line below which you then have to be jumping over. I think it is easier to trouble shoot program logic if all code is in one line.

I know what you are thinking. If a line has fifteen statements in it, how do I find which one caused the Syntax Error or whatever bombed in that line? One way is to edit a number of *STOP* statements into the line. Each time BASIC meets a stop it stops the program and says *BREAK IN XYZ*. When you type *CONT*, BASIC will pick up with the code after the *STOP*. If you put three *STOPs* in a line and get two *BREAKs* and then the *SN ERROR*, you have narrowed your problem to only that code between the second and third *STOP*.

Multiple statements in a line save memory. Remember each line of BASIC in memory has two bytes for the line number, two bytes for the address of the next line and the 0 at the end. Each time you can combine two lines into one, you save five bytes. When you combine 10 lines into one, you save 50 bytes. The savings can really mount up and the program will run faster, too.

While we are talking about line numbers, what is sacred about spacing lines 10 apart? This leaves room for adding in new code later if needed. I like small line numbers. It takes one byte less to *GOTO 100* than to *GOTO 1000*. I like *GOTO 10* even better.

Don't feel that when the program is done you need to renumber to get back your spacing of 10 line numbers. This is more harmful than helpful if you need to edit later. As you wrote the program you got used to certain things being at certain lines and now *RENUM* will change all that. I assign blocks of code to line number blocks of 50 or 100 and even write at spacings of two to get in all I need to. As I work up a program, I know exactly which block to go to to change something. For example, I always put a main menu at 1000 and tape and disk I/O between 900 and 1000. When the program is done I may *RENUM 0,0,1* to start the program at line 0 with spacing of 1. This uses least memory. I make sure to save a copy of the program before I do a *RENUM*. If problems develop later I go to the "uncompressed" version, edit it and then *RENUM* it to get a new working version.

Note in all of this, that the guiding principle is what makes it easiest for you, the programmer. CoCo could care less how far the lines are spaced or what's in them as long as syntax is right. Also CoCo is not concerned about program logic, but just does what it's told. If you find it easier to line number at intervals of 10 and put only one or two statements per line, then that is the right way for you.

## THE SPECTRUM VOICE PAK

A CoCo voice synthesizer that is a complete phoneme based voice system that uses the famous VOTRAX SC01 chip in a cartridge style pak. It provides an unlimited vocabulary with text to speech software and a Word Manager that constructs and edits custom user dictionaries. Fully assembled, and ready to plug in and talk, talk, talk! **\$69.95**

## TALKING SOFTWARE

**Talking Final Countdown** - You must stop the mad general from launching a missile at the Russians and causing WW III ! Has multiple voices for added realism. 32K EXT **\$24.95**

**Educational Software** - Computer Island's educational programs turn your CoCo into a true teaching machine. Reinforce basic lessons with the aid of voice. Three/pak special includes Math Drill, Spelling Tester and Foreign Languages. 16K EXT **\$24.95**

**Talking Score E-Z** - An excellent adaptation of a Yahtzee type program with added speech. Up to 6 players can compete at a time, and all scoring and record keeping is done by the computer. 32K EXT **\$24.95**

**Term Talk** - A speaking smart terminal program for your CoCo. It contains all the features of an intelligent communications package, plus it talks! (Shades of War Games) 16K EXT Tape **\$39.95** Disk **\$49.95**

### SPECTRUM PROJECTS

93-15 86th Drive

PO Box 21272, Woodhaven, NY 11421

(212)441-2807

All orders plus \$3.00 S/H

NY Residents add sales tax

CoCo II Owners please specify

# COLORFUL UTILITIES

\*\*\*\*\*

**DOUBLE DOS** - Now access 10 more granules from your 40 track drive and still be compatible with RS DOS! Also works with double-sided and 80 track drives! DISK **\$24.95**

\*\*\*\*\*

**MULTI-PAK CRAK** - Save ROMPAKs to your 64K Disk system using the RS Multi-Pak Interface. Eliminate constant plugging in of ROMPAKs now by keeping all your PAK software on disk. DISK **\$24.95**

\*\*\*\*\*

**TAPE OMNI CLONE** - Easily handles programs with auto loaders, no headers, no EOF markers, unusual size blocks and more! Now is the time to get your tape software collection protected against loss. TAPE **\$24.95**

\*\*\*\*\*

**DISK OMNI CLONE** - Back everything up! This amazing program handles "non standard" disks with ease. We haven't found any disk yet that it can't handle. Lowest price too! 32K DISK **\$29.95**

\*\*\*\*\*

**DISK MANAGER** - Rescue crashed disks, date files on the disk directory, print a Super directory with ML addresses, maintain and sort a catalog of up to 300 files from a collection of disks! 16K DISK **\$29.95**

\*\*\*\*\*

**BASIC AID** - Speed program entry by single key input of 43 common BASIC commands. Redefine any or all keys. Merge, move and renumber any part of your program. Comes with a plastic keyboard overlay. ROMPAK **\$34.95/DISK \$49.95**

\*\*\*\*\*

**COLOR KIT** - Adds 35 commands to BASIC! Light or dark screen, key click, screen editor, echo to printer, BREAK disable, convert ML to DATA and double space printouts of program listings. TAPE **\$34.95**

\*\*\*\*\*

**BASIC COMPILER** - Convert your BASIC programs into fast efficient machine language. Produces code more compact and up to 50Xs faster than original BASIC. Integer compiler with no Extended BASIC needed. 16K-64K versions included. TAPE **\$39.95**

\*\*\*\*\*

**SCHEMATIC DRAFTING** - Save hours of work and design professional looking electronic diagrams using a 480X540 pixel worksheet with 6 viewing windows. Over 30 electronic symbols with 10 user definable symbols are provided. Dump hard copy to the printer and save the created schematics to disk. 64K DISK **\$49.95**

\*\*\*\*\*

**CCEAD** - Color Computer Editor Assembler Debugger is a cost effective machine language development tool. Ideal for learning the basics of Assembly Language. TAPE **\$6.95**

\*\*\*\*\*

**THE STRIPPER** - A machine language utility designed to cut the size of BASIC programs for run-time efficiency. Delete REMARKS, pack statement lines and remove spaces. Get more performance for only **\$7.95**

In Canada Call MICRO R.G.S. Toll Free  
800-361-5155



# COLORFUL UTILITIES

\*\*\*\*\*

**FAST DUPE** - The fastest Disk copier ever! Will format and backup a diskette in only one pass and can make up to 4 Disk copies at once! The must utility for every Disk owner. 64K DISK **\$19.95**

\*\*\*\*\*

**HIDDEN BASIC** - A protection feature for your BASIC programs. Modify your code so CLOAD, CSAVE, LIST, EDIT, DEL and LLIST will not function. TAPE **\$19.95**

\*\*\*\*\*

**64 COLUMN MOD I/III EMULATOR** - Give your CoCo a 64X16 screen. Run Model I/III BASIC graphic routines without retyping the graphics statements. 64K DISK **\$19.95**

\*\*\*\*\*

**64K DISK UTILITY PACKAGE** - Take advantage of an expanded 64K machine. Make an additional 8K of RAM available. Copy ROM cartridges to disk and create a 32K SPOOL buffer for printing. DISK **\$21.95**

\*\*\*\*\*

**TAPE UTILITY** - A powerful package that transfers tape to disk and disk to tape automatically. Does an automatic copy of an entire disk of programs and data to tape. TAPE/DISK **\$24.95**

\*\*\*\*\*

**E-X-T-E-N-D-E-D DISK BASIC** - Add new powerful commands to your 64K Disk system. Inverse Video (GREAT for monitors!), Wild Card Directory, Double POKE and PEEK, NSAVE, NLOAD, LDIR, OLD and TYPE. DISK **\$24.95**

\*\*\*\*\*

**GRAPHICOM** - The ultimate CoCo graphics development system with sophisticated graphics editing, preview animation, telecommunications and printer support. Hi-resolution graphics for only **\$24.95** 64K DISK

## COLORFUL UTILITY CHECK LIST:

- |   |   |
|---|---|
| <input type="checkbox"/> DOUBLE DOS         | <input type="checkbox"/> CCEAD                      |
| <input type="checkbox"/> MULTI-PAK CRAK     | <input type="checkbox"/> THE STRIPPER               |
| <input type="checkbox"/> TAPE OMNI CLONE    | <input type="checkbox"/> FAST DUPE                  |
| <input type="checkbox"/> DISK OMNI CLONE    | <input type="checkbox"/> HIDDEN BASIC               |
| <input type="checkbox"/> DISK MANAGER       | <input type="checkbox"/> 64 COL MOD I/III EMULATOR  |
| <input type="checkbox"/> BASIC AID          | <input type="checkbox"/> 64K DISK UTILITY PACKAGE   |
| <input type="checkbox"/> COLOR KIT          | <input type="checkbox"/> TAPE UTILITY               |
| <input type="checkbox"/> BASIC COMPILER     | <input type="checkbox"/> E-X-T-E-N-D-E-D DISK BASIC |
| <input type="checkbox"/> SCHEMATIC DRAFTING | <input type="checkbox"/> GRAPHICOM                  |

**SHIPPING \$3.00 - NY RESIDENTS ADD SALES TAX**

## SPECTRUM PROJECTS

93-15 86TH DRIVE

PO BOX 21272, WOODHAVEN, NY 11421

212-441-2807

# ..... A .....

# ..... SPECTRUM PROJECTS .....

# ..... SHOPPING LIST .....

.....

## A Chip Off The Old...

16K RAM Chips .....\$12.95  
 6822 Industrial Grade PIA .....\$14.95  
 6847 VDG Chip .....\$17.95  
 CoCo II 16K Chips (5 volts) .....\$19.95  
 68764 Eprom (Fits Ext BAS socket).\$24.95  
 16K-32K Upgrade Kit .....\$25.95  
 6883 SAM Chip w/heat sink .....\$29.95  
 6809E CPU Chip .....\$29.95  
 Basic ROM 1.2 Chip .....\$39.95  
 Disk ROM 1.1 (New DOS Command) ..\$39.95  
 64K RAM Chips (Spectrum Special) ..\$49.95  
 Extended Basic 1.1 ROM .....\$69.95  
 CoCo First Aid Kit (Be Prepared)  
 (2 6821's, 6809E & 6883) .....\$69.95  
 Eprom Programmer - (2716, 2732, 2764 &  
 68764) - NO PM's needed ! .....\$139.95

## CoCo Library...

Color Computer Tech Manual .....\$7.95  
 The World Connection - All about Bulletin  
 Boards, Modems and the World's Most  
 Famous Sysop ! .....\$9.95  
 CoCo Memory Map .....\$12.00  
 Your Color Computer .....\$12.95  
 Color Computer Graphics (Inman) ..\$12.95  
 CoCo Secrets Revealed .....\$14.95  
 Color Computer Interfacing .....\$14.95

## More Good Stuff...

Lowercase Board .....\$59.95  
 Botek Printer Interface .....\$69.95  
 The Spectrum Switcher - Have your Disk  
 & Cartridge too! Dual Slot System \$69.95  
 Colorama - Run your own BBS! .....\$99.95  
 Disk Interface (Spectrum Special)\$139.95

## CoCo Cables And...

Four Pin Male to Four Pin Female  
 Extension - 15 feet. Move your printer or  
 modem to another location .....\$14.95  
Tired of plugging and unplugging devices  
 from the RS232 port? Make your life  
 easier. Try our RS232 "Y" cable ..\$19.95  
OS-9 Null Modem Cable - Now timeshare  
 with another CoCo or MC-10 .....\$19.95  
Spectrum Light Pen .....\$19.95  
Disk Interface/Rom Pak Extender - Move  
 your disks and ROM Paks where you want  
 them (3 feet) .....\$29.95  
Triple RS232 Switcher - Now select one  
 of any three RS232 peripherals ...\$29.95  
Two Drive Disk Cable .....\$29.95

## Other Good Stuff...

C-10 tapes in any quantity .....49 cents  
 5 1/4 Diskettes in any quantity ...\$1.99  
 32K RAM Button .....\$2.99  
 Joystick plug .....\$3.99  
 64K RAM Button .....\$4.99  
 Rompak w/Blank PC Board .....\$9.95  
 The Spectrum Remote Reset .....\$12.95  
 The Disk Doubler - Doubleside your 5 1/4  
 diskettes .....\$14.95  
 Video Clear - Cleanup TVI!!! .....\$14.95  
 Rapid Fire Adapter - (Requires WICO  
 Command Control Interface) .....\$14.95  
 Cassette Recorder Stand .....\$19.95  
 Bio Feedback Detector .....\$34.95  
 Epson Printer Interface .....\$49.95  
 CoCo Cooler (D & E Rev. boards) ..\$49.95

**SPECTRUM PROJECTS**

**93-15 86th DRIVE**

**PO Box 21272**

**WOODHAVEN, NY 11421**

**All orders plus \$3.00 S/H**  
**NY Residents add sales tax**

**(212)441-2807**



Be A 'Doctor Of Dunk'  
With . . .

In sports, you can't beat the real thing. The crack of the bat splitting a steamy afternoon; the spiral of a football through an apple cider evening; the swish of the net joining the swoosh of the wintry wind outside.

But for the traditional sports fun, the real thing isn't enough. Too often there are no games on TV (horrors!) or at the local gym, and you are left to play board or computer versions.

Now, sports simulations on a microcomputer can be fun, but they can also become boring for someone interested in recreating the real-world game. In many cases, sports simulations are arcade-type adaptations. What our dedicated sports fan is looking for is something that allows him to make coaching or managing decisions; that permits him to create teams that emulate real-world teams, with varying strengths and weaknesses; that provides realistic results both in play-by-play and in season-long action; and that does all this without being too complicated.

Of the three major U.S. sports—baseball, football and basketball—it is basketball that provides the biggest challenge in finding a happy balance between realism and ease of play. To keep track of all 10 players on the court becomes too confusing and bogs down a game that must keep moving. Yet we want more than simply, "Team A has the ball."

By Gary J. Carter

## BASKET

Play By Play  
Simulation  
Challenge

*(Gary Carter, a University of Illinois graduate, has worked as a reporter and copy editor in Virginia and Illinois. Since 1982, he has been system manager of the videotext service of the Bloomington [Ill.] newspaper. He was playing and creating sports simulation games long before discovering computers.)*

Will they shoot?"

*Basket* was created by this fan with the above ideas in mind. It is not the ideal solution, but I think it does aim in the right direction. This is not a fancy program, nor a pretty one. You'll find subroutines popping up like weeds all through it. Like my garden, it wasn't planned that way. That's just how it grew.

You can play either a college or a high school version. First, *PCLEAR 1*, then load and *RUN* the program. For each team you will be asked to enter ratings in four categories: outside shooting, inside strength, defense and quickness. In each case the ratings should be in the range of .3 (poor) to .7 (best), with .45 to .5 as the average.

"Outside shooting" represents the general shooting percentage of the guards, whose range is considered to extend to 20 feet. "Inside strength" roughly corresponds to the height and strength of the team's center and forwards. It represents their shooting percentage within 10 feet (except for shots under the basket) and their rebounding ability.

The defense rating is used alone when the team is in a zone defense (lines 8010-8011) and combines with quickness for a man-to-man defense (8200-8201). Quickness and defense also determine a team's ability to drive to the basket (8640). Defense combines with inside strength on defensive rebounds (3030-3040) and quickness affects turnovers (513-516, 1025).

After the ratings are entered you will see an empty scoreboard and statistics chart showing field goals attempted (FGA), field goals (FG), free throws attempted (FTA), free throws (FT), rebounds (RB) and fouls. This chart will appear after each period, and can be viewed before shooting free throws. After play starts, the list also will contain turnovers (TO), field goal percentage (FG PCT) and free throw percentage (FT PCT).

Next, you can select to coach both teams (two-person game), coach vs. CoCo (one-person game), let CoCo play by itself or let CoCo play until the final few minutes.

If you choose option 2, you will coach team 1 while the computer makes the decisions for team 2. In option 3, the computer directs both teams.

If you choose the last option, you will be asked, "How many minutes?" That is, at what point do you want the computer to hand the coaching duties over to you? Then you will be asked, "Switch to which mode?" Select 1 or 2, coach both teams or coach vs. CoCo. (When the clock gets to the point you specified, the program will pause to tell you it is time to change modes.)

Once the game starts, the action keeps moving. If no option is selected within a certain length of time when an option menu appears on the screen, the program will select a default response and continue. (When the computer is coaching, of course, it will make decisions of its own.)

The length of time can be varied by pressing the up arrow

		Rainbow Check Plus			
17	.....	02C3	193	1050.....17D2	238
53	.....	0540	44	4003.....19DE	244
100	.....	0764	61	5010.....1C4D	4
402	.....	09F4	159	6110.....1E6F	92
554	.....	0C1D	23	7040.....2134	59
644	.....	0E53	105	8200.....23CE	16
740	.....	1080	73	8475.....2680	186
818	.....	12EB	245	8610.....2865	161
950	.....	1550	177	END.....2B3E	242

The listing:

```

1 CLS:2-27-83
2 PRINTTAB(10)"BASKETBALL":PRINT
TAB(7)"BY GARY L.CARTER":REM 171
0 WILDWOOD, BLOOMINGTON IL 61701
3 INPUT"HIGH SCHOOL OR COLLEGE";
LV$:IFLV$<>"H"ANDLV$<>"C"THEN3
4 IFLV$="C"THENN1=2
5 DIMG(1),S(1),Z$(1),Y$(4):G(0)=
2:G(1)=2:DL=100:Y$(1)="MAN":Y$(2
)="ZONE":Y$(3)="GO FOR BALL"
7 CLS:IFLV$="H"THENMM=8:H$="1ST
QTR":GOTO26
8 MM=20:H$="1ST HALF":GOTO26
9 FORL=1TODL
10 Q$=INKEY$:IFQ$=""THEN11ELSEIF
Q$=CHR$(10)THENDL=DL+9ELSEIFQ$="
^"THENDL=DL-9:IFDL<1THENDL=1
11 NEXT:RETURN
12 PRINT"WILL YOU:":PRINT"COACH
BOTH TEAMS(1)":PRINT"COACH VS. C
OCO(2)"
14 PRINT"LET COCO PLAY(3)":INPUT
"OR LET COCO PLAY UNTIL FINAL
FEW MINUTES(4)";CP
15 IFCP=1THENPRINTA$" USES THE 1
-4 KEYS; ",B$" USES THE 7-0 KEYS.
", "PUSH <ENTER> WHEN READY":LINE
INPUTQ$
17 IFCP=4THENINPUT"HOW MANY MINU
TES";E:INPUT"SWITCH TO WHICH MOD
E";Z
18 IFCP=2THENPRINT"YOU ARE "A$, "
USE KEYS 1-4"
19 PRINT:PRINT"USE THE ARROW KEY
S TO SPEED up OR SLOW down THE
PROGRAM":FORX=1TO4:GOSUB9:NEXT:G
OTO155
26 INPUT"FIRST TEAM'S NAME IS";A
$
28 INPUT"OUTSIDE SHOOTING (.3-.7
)";OA
30 INPUT"INSIDE STRENGTH (.3-.7)
";IA
31 INPUT"DEFENSE (.3-.7)";DA
32 INPUT"QUICKNESS (.3-.7)";QA
33 INPUT"CHANGES";Q$:IFQ$="C"THE
N26
35 INPUT"NEXT TEAM'S NAME IS";B$
36 INPUT"OUTSIDE SHOOTING (.3-.7
)";OB
37 INPUT"INSIDE STRENGTH (.3-.7)
";IB
38 INPUT"DEFENSE (.3-.7)";DB
39 INPUT"QUICKNESS (.3-.7)";QB
40 INPUT"CHANGES";Q$:IFQ$="C"THE
N35
42 IFLEN(A$)<LEN(B$)THEN45

```

to speed up the program or the down arrow to slow it down. This works only when the clock is running, or when the message is on the screen before each period. Note lines 9 through 11, the delaysubroutine. Each time through, line 10 checks for the arrow keys and adds to or subtracts from DL accordingly. DL determines the length of the FOR/NEXT loop in Line 9.

As the game starts, the top line on the screen will identify the team with the ball (we still have the old jump ball before each period). The second line will show what alignment the defensive team used the previous time down the floor. This will be blank the first time, of course.

Below this will appear a prompt for the defensive coach to select a defensive alignment. If he makes no choice within the time limit, the defense used last will be retained. The prompt line looks like this:

```
(TEAM NAME) MAN (1-7), ZONE (2-8)
GO FOR BALL (3-9), OR FOUL (0-4)
(Foul and go for ball are for desperate situations.)
```

Here's what those numbers mean: The player directing team 1 will use keys 1, 2, 3 and 4 to make his selections. The player directing team 2 (if any) will use keys 7, 8, 9 and 0. It is up to the players to keep track of who is on offense and who is on defense. I've found the game works best if the defensive player keeps his hand off the keyboard except when he needs to make a choice.

After the defensive choice is made, the screen will clear, the top lines will reappear and the computer will tell whether the ball is in the hands of a guard or a "big man" (center or forward), how far he is from the basket and whether he is open or guarded. Below this you will see:

```
PRESS (SPACE) TO SHOOT
(1-7) TO DRIVE
(2-8) TO STALL
```

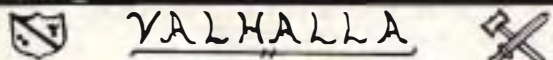

## VALHALLA

VENTURE WITH YOUR LEGIONS INTO THE MYSTICAL LAND OF VALHALLA TO CONQUER ALL AND REIGN SUPREME IN THIS TOTALLY HI-RES. COMPLETELY JOYSTICK CONTROLLED. STRATEGY GAME. THE BEAUTIFULLY DETAILED TERRAIN MAP INCLUDES CASTLES, VILLAGES, ROADS, RIVERS, SWAMPS, LAKES, BAYS, AND MOUNTAINS. TWO TO FOUR PLAYERS CONTROL SIXTEEN ARMIES LED BY LORDS, GENERALS, OR CAPTAINS. EACH ARMY FEATURES HEAVY CALVARY, LIGHT CALVARY, FOOT SOLDIERS, AND ARCHERS.

A SUPERB GAME FOR ONLY \$24.95.

CHECK OR MONEY ORDER ONLY AVAILABLE ONLY FROM \*HYCOMP\*

AVAILABLE ONLY FROM

P.O. BOX 15331  
TULSA, OK 74158  
(918)266-6452

ALL ORDERS 1.50 SHIPPING GAMES REQUIRE 32K, EXT. BASIC, AND DUE TO MEMORY REQUIREMENTS ARE AVAILABLE ONLY ON CASSETTE



## COLONIAL TRILOGY



THE INCREDIBLE SAGA OF THE STRUGGLES BETWEEN TWO RACES AT THE EDGE OF OUR GALAXY

COLONIAL WARS: ONE PLAYER COMMANDS THE COLONIAL HOMEWORLDS AND ALL THEIR FORCES WHILE THE OTHER PLAYER LEADS THE INVADING ZYRON EMPIRE. THE ULTIMATE IN TWO PLAYER STRATEGY GAMES WITH HYCOMP'S UNIQUE SPLIT SCREEN CONCEPT, GAME SAVE, AND 10 PAGE INSTRUCTION MANUAL (3-8hrs)

ZYRON: THE SIEGE OVER ONE OF THE COLONIAL HOMEWORLDS AND THE ATTEMPT TO BREAK IT IS THE SETTING FOR THIS TWO PLAYER GAME. FEATURES INCLUDE CUSTOM BUILT FIGHTERS AND FREIGHTERS, 300 LOCATION HI-RES PLAYING GRID, SEVEN PAGE MANUAL, TWO SCENARIOS, AND PLAYING AID (2-4hrs)

QUESTAR: ONE PLAYER EXPLORES OVER 30 PLANETS ON A DARING MISSION TO DESTROY A HIDDEN ZYRON BASE IN THIS EXCELLENT GRAPHICS ADVENTURE (60-90min)

ONLY \$19.95 EACH OR  
ALL THREE FOR \$49.95!



```
43 IFLEN(B$)<LEN(A$)THEN46
44 CLS:GOTO50
45 A$=" "+A$:GOTO42
46 B$=" "+B$:GOTO43
50 IFLEFT$(H$,3)<>"1ST"THEN55
52 AA$=A$+"-"
53 BB$=B$+"-"
54 GOTO58
55 AA$=AA$+"-"+STR$(S(0))
56 BB$=BB$+"-"+STR$(S(1))
58 GOSUB60:GOTO120
60 GOSUB2550:PRINT@22,H$
64 PRINT@64,AA$
66 PRINTBB$
69 PRINTTAB(16-LEN(A$))A$TAB(27-
LEN(B$))B$
70 PRINT"FGA"TAB(14)AU TAB(23)BU
72 PRINT"FG"TAB(14)AV TAB(23)BV
74 PRINT"FTA"TAB(14)AW TAB(23)BW
76 PRINT"FT"TAB(14)AX TAB(23)BX
78 PRINT"RB"TAB(14)AR TAB(23)BR
80 PRINT"FOULS"TAB(14)AF TAB(23)
BF
82 IFAU=0ORB=0THEN92
85 PRINT"TO"TAB(14)AT TAB(23)BT
90 PRINT"FG PCT"TAB(13);:PRINTUS
ING".### ";AV/AU,BV/BU
92 IFAW=0ANDBW=0THEN101
94 IFAW=0THEN98
95 IF BW=0THEN100
96 PRINT"FT PCT"TAB(13);:PRINTUS
ING".### ";AX/AW,BX/BW:GOTO1
01
98 PRINT"FT PCT"TAB(22);:PRINTUS
ING".###";BX/BW:GOTO101
100 PRINT"FT PCT"TAB(13);:PRINTU
SING".###";AX/AW
101 IFPR THENRETURNELSEIFH$="FIN
AL"THEN9500
102 PRINT"PRESS ANY KEY TO CONTI
NUE"
104 F=RND(0):J$=INKEY$:IFJ$=""TH
EN104
105 RETURN
120 IFH$<>"HALFTIME"THEN145
121 H$="2ND HALF":MM=20
122 VA=0:VB=0
145 CLS:GOTO12
155 F=RND(0)
160 IFF<.5THEN=1
161 GOSUB5000:GOSUB9000
180 GOSUB9:DEF OPT
183 IFG(TT)>2THENG(TT)=2
185 K=0:GF=0:XX=0:RB=0
190 PRINT:PRINTD$ "MAN(1-7), ZON
E(2-8),":PRINT "GO FOR BALL(3-9
), OR FOUL(4-0)"
191 IFCP=1THEN195
192 IFCP=2ANDT=1THEN195
```

### (3-9) TO PASS

If no choice is made within the time limit, Pass is selected. Both players use the space bar to shoot. Free throws are shot automatically. You'll hear a "beep" when points are scored.

Passing is most effective against the zone defense; driving is most effective against a man-to-man. Shooting is most effective when the ball-handler is open and within 20 feet for guards or 10 feet for big men.

If a shot is good or the ball is turned over out of bounds, the screen will clear to orange to indicate the ball changes hands, and the new defensive team will be asked to choose among fall back, press, go for the ball or foul. The default choice is fall back. If the ball does not go out of bounds when it changes hands (defensive rebound, for instance), this option is not available.

Missed shots sometimes are tipped back up automatically, sometimes are knocked to the backcourt, and sometimes result in fast breaks that lead automatically to layups.

After a team commits 20 fouls, and every five fouls thereafter, it is arbitrarily assumed that a player has fouled out, and the team's defensive rating and either the outside or inside ratings drop .05 each. If the program says player 1 or 2 has fouled out, a guard leaves and the outside rating drops. Otherwise, a big man leaves and the inside rating drops.

That's about all you need to know to play *Basket*. You'll find that sometimes scores seem to go against the ratings; a poor team upsets a good one, or two evenly matched teams can end up 20 points apart. But this can happen in real basketball, too, and much depends upon the player's strategy and shot selection. And then, sometimes you get the breaks and sometimes you don't. That's the way the keyboard bounces.

## COLOR COMPUTER Buyers Club

- Members enjoy a 25-40% savings on software!
- Over 500 programs from 38 companies to choose from!
- More software constantly being added!
- Hardware & accessories at substantial savings!
- Special order service for members!
- No service charge for VISA or MCI
- Your savings can far exceed your dues!

### Join Today and Start Saving!

Dues are \$24.50 - We accept  
Personal Checks, M.O. or Charge It!



NAME \_\_\_\_\_

ADDRESS \_\_\_\_\_

CITY \_\_\_\_\_ STATE \_\_\_\_\_ ZIP \_\_\_\_\_

VISA  MC \_\_\_\_\_

Exp. Date \_\_\_\_\_ Bank # \_\_\_\_\_ (MC only)

Mail to: **Color Computer Buyers Club**  
P.O. Box 241  
Eaton Rapids, MI 48827

```
193 GOSUB6000:GOTO225
195 FORL=1TO(DL*2)
200 J$=INKEY$:G=VAL(J$)
203 IFT THEN207
205 G=G-6:IFJ$="O"THENG=4
207 IFG>0ANDG<5THEN225
210 NEXTL
215 GOTO230
225 G(TT)=G:Z$(TT)=Y$(G)
230 ONG(TT)GOTO500,500,245,400
245 F=RND(7):GF=1:SS=SS-RND(2)
250 ONF GOTO640,640,640,700:GOTO
500
400 PRINTD$" INTENTIONAL FOUL"
402 K=2:SS=SS-RND(2)
404 GOTO619
500 'OFFENSE RESULTS
505 PRINT"PASS":GOSUB9:D=G(TT):I
FDV>4THENPRINT"3-SECOND CALL":BG
=1:DV=0:GOTO706
510 IFXX=0THEN520
512 F=RND(0):IFT THENQ=(QA-QB+.5
)/(4*D)ELSEQ=(QB-QA+.5)/(4*D)
514 IFF<Q THEN700
515 IFF<Q+(.01/D)THEN675
516 IFF<Q+(.03/D)THEN640
520 K=0:GOSUB2500:IFCL=1THEN930
525 RB=0
527 XX=XX+1:IFXX>4AND(RA>250RMM=
0)THEN180
530 IFST=1THEN8000
535 IFS=1THEN538
536 GOSUB8000:IFCL THEN930
537 IFS$<>" "THEN505
538 S=0:H=RND(10):F=RND(0):PRINT
"SHOOT":GOSUB9
539 IFPC>.6THENF=F+.2ELSEIFPC<.3
5THENF=F-.2
540 IFF>OF THEN542
541 IFH=1THEN590ELSE575
542 IFH=1THEN615
543 F=RND(0):IFF<.06THEN790
546 IFT THENR=BB ELSE R=BA
550 G=.4+(R*.1):F=RND(0)
554 IFF<G THEN720
556 GOTO800
575 'BG
576 S=0
577 S(T)=S(T)+2:IFT=0THEN581
579 BU=BU+1:BV=BV+1:GOTO583
581 AU=AU+1:AV=AV+1
583 BG=1:PRINT "BASKET GOOD":SOU
ND150,2
587 GOTO870
590 'BG, FOUL
592 S(T)=S(T)+2:IFT=0THEN596
594 BU=BU+1:BV=BV+1:AF=AF+1:GOTO
598
596 AU=AU+1:AV=AV+1:BF=BF+1
```

# MASTER CONTROL II

from Soft Sector Marketing

Cut Your Programming Time 50% - Improve Accuracy



Master Control II is a machine language program designed to increase the speed in which it takes to write basic programs, by providing the most commonly used program statements with two keystrokes rather than having to type the entire command. The program is relocatable and can be placed anywhere in memory, normally the top 1616 bytes of RAM, it will work on 16K and 32K systems.

- 51 preprogrammed command keys of standard and extended basic commands
- Direct control of motor, trace and audio functions.
- Relocatable machine code, now works with disc systems.
- Automatic line numbering, starting point and increment are alterable
- Programmable custom key, you can select your own special function

- Direct run key, run the program as you write it.
- Plastic keyboard overlay for easy program use.
- Easy entry of commands into program statements
- New, complete easy to understand instruction manual

Only **\$19.95**

## E.T.T. ELECTRONIC TYPING TEACHER by CHERRYSoft



Learning to type the right way can save you hours of tedious work when entering programs into your CoCo, and this is just what ETT was designed to do. Devote a little time every day practicing with ETT and before you know it you will be typing with confidence. Entering those programs will no longer be the chore it used to be.

ETT's video keyboard lets you practice with all the keys labeled, all the keys blank or only the "home" keys labeled. The visual cues guide you while you learn to type without watching your fingers. ETT shows your accuracy, response time, and words per minute. You will quickly see that you are improving with practice.

With the sentences provided by ETT learning to type can be fun, over 1000 variations, chosen because they include every letter in the alphabet. You can also create your own practice sets. This outstanding program was written by a certified teacher and professional programmer and comes with a ten page student manual-study guide. Requires 16K Extended Basic.

- Dealer Inquiries Invited - **Cassette \$21.95**

## ELITE-CALC

The Color Computer Worksheet Calculator Program You Have Been Waiting For!!

ELITE-CALC is a powerful, full featured worksheet calculator for your Color Computer. The all machine language program will help you answer "what if" questions, prepare reports, maintain records and perform other tasks. Has all the features you want. Individual cell formulas, Copy blocks of cells, Full cell-edit capability, Sorts, Graphs. Easy to use. Works with all printers. Comprehensive manual and sample worksheets included. A serious tool for those who want to do more than play games.

Available on  
Tape or Disc **\$59.95**  
for only

- all ELITE Software available -

## TIMS . . . by Sugar Software

Tape Information Management System

A powerful, personal database manager that is easy and enjoyable to use. Just drop the cassette into your tape recorder and load into your computer. TIMS starts up automatically with prompts that will have you up and running in minutes without any uncertainties about what to do next. Here is an electronic file box with 1 to B user definable categories. Great for maintaining mailing lists, rosters, stamp or coin collections, etc. The documentation included with TIMS is excellent. On the reverse side of the cassette you get another copy which allows you to modify the program to suit your special requirements or modify for disc operation. Order your copy of TIMS today and get things organized the easy way, you'll love it! Requires Extended Basic, 32K Recommended.

**Cassette \$24.95**

**DOODLE BUG**  
- Like Pac Man with turntables -  
Tape **\$24.26** Disc **\$26.95**

**KEYS of the WIZARD**  
- Best Selling Adventure -  
Cassette **\$18.88**

**DONKEY KING - Tom Mix**  
SUPERB GRAPHICS - A Screens  
Requires 32K  
Tape **\$24.95** Disc **\$26.95**

**GHOST GOBLERS**  
- Best Pac Man type game available!!  
Cassette **\$18.88**



## BLOC HEAD

Q-BERT never looked so good! You guide Bloc Head from cube to cube, changing the brightly colored surfaces while dodging the despicable characters they try to push him off. He must clear the cubes to go to the next skill level. Requires 16K.

**Cassette \$26.95**



## JUNIOR'S REVENGE

The same Junior you've seen in the Kong arcade series. This young but tireless little ape must overcome four screens of obstacles to rescue his father. The King, from mean old Luigi. He will traverse the jungle & the swamp, climb vines, avoid vine gators, dodge Zuzu birds, open locks & finally conquer Luigi's hideout before he finally frees his daddy. Requires 32K.

**Cassette \$28.95**

## ADVENTURES IN WONDERLAND

from Prickly-Pear Software

A fantasy world peopled with the creatures of Lewis Carroll's imagination. "Alice's Adventures in Wonderland", "Through the Looking Glass", and "The Hunting of the Snark" have been blended into a delightful landscape. You will play the role of Alice as you wander through the garden of live flowers, the treacherous Tugley Wood, the chessboard landscape, the wabe and all the other familiar Wonderland scenes.

The program has a vocabulary of hundreds of words and uses a full ELIZA type intelligence. Machine Language 32K

**Cassette \$24.95**

**Disc \$29.95**

All PRICKLY-PEAR Software available

## THE FACTS For The Color Computer

A must book for the Color computer owner! The first document to provide information that will allow the user to take advantage of all the features of the Color Computer. Aimed at the machine language user. The FACTS attempts to explain, and describes in detail, how the user can make use of the computers internal features. Divided into two sections: Hardware and software; the primary emphasis is on hardware capabilities and circuits. Provides detailed explanations of all the internal large scale integrated circuits. Includes schematic and spec. sheets. 166 pages. Order your copy today!

ONLY **\$12.95**

**MasterCard VISA CoCo Warehouse**

Where Shopping By Mail is "USER FRIENDLY"  
500 N. DOBSON - WESTLAND, MI 48185  
Phone (313) 722-7957

## WRITE FOR OUR FREE CATALOG

HOW TO ORDER BY MAIL: For prompt and courteous shipment, SEND MONEY ORDER, CERTIFIED CHECK, CASHIERS CHECK, MASTERCARD/VISA (include card number, inter-bank No., expiration date and signature). PERSONAL AND BUSINESS CHECKS MUST CLEAR OUR BANK BEFORE PROCESSING. Shipping and packaging charge of \$2.50 minimum must be added to all orders in continental US (Canadian orders \$5.00 minimum). Michigan residents include 4% sales tax 10% deposit required on C.O.D. orders.

NO REFUNDS ON SOFTWARE

Special -

**TABLE 1**

**Lines**

1-8	Housekeeping	850-856	Fast break
9-11	Delay subroutine	870-925	Wrap up trip down floor
12-19	Mode of play routine	890	Offensive guard rebound? Then jump
26-40	Input ratings	920	Foul on press? Then jump
42-58	Prepare team names and score for readout	925	Ball out of bounds? Then jump
60-105	Statistics readout subroutine	930-950	Time ran out; housekeeping
104	Vary random number	960-970	Need overtime?
120-145	Housekeeping	1000-1013	Choose press
155-161	Jump ball	1015-1016	Go for ball
180-230	Choose defense	1020-1050	Press
245-250	Go for ball	1170-1190	Ball across center line
400-404	Intentional foul	2500-2535	Timekeeping subroutine
500-856	Offense results	2550-2560	Time printout subroutine
500-516	Pass/Drive look for turnover	3000-3050	Set offense, rebound factors
520-527	Pass/Drive check time, defense option	4000-4160	Shoot free throws
530	Stall? Then jump	5000-5060	Change possession
535-537	Shooting? Then jump, else check again	6000-6080	Computer coach choose defense
538-830	Shot results	6100-6110	Computer coach choose press
539-543	Jump to various results	6500-6620	Computer coach choose offense action
546-556	Decide who gets rebound	7000-7202	Foul tote, foul out
575-587	Basket good	8000-8654	Locate ball, choose offense action
590-610	Basket good, foul	8000	Sometimes nobody is open
615-633	No good, foul	8010-8110	Locate ball vs. zone
640-666	Defense foul before shot	8200-8240	Locate ball vs. man-to-man
675-687	Offensive foul	8300-8320	Locate ball vs. go for ball
700-710	Turnover	8310	Back door play
720-784	No good, offensive rebound	8400-8420	Who has ball?
740-760	Tipped up	8425-8440	Guarded? Print where
790-796	No good, rebound out of bounds	8450-8488	Compute shot percentage
800-818	No good, defensive rebound	8490-8540	Choose offense action
825-830	No good, foul on rebound	8600-8654	Drive/Stall routine
		9000-9060	Team with ball/score readout

**YOUR TRS-80\* SPECIALISTS  
IN CANADA**



SOFTWARE FROM  
ADVENTURE INTERNATIONAL  
COMPUTERWARE  
TOM MIX  
MED SYSTEMS  
SPECTRAL  
PRICKLEY PEAR  
PROGRAMMERS GUILD  
COGNITEC  
PRISM  
DATASOFT  
AND MORE

DISK DRIVES  
EPSON PRINTERS  
MARK DATA KEYBOARD KITS  
WICO & KRAFT JOYSTICKS  
BOOKS & MAGAZINES

VISA & MASTER CARD  
ACCEPTED

WRITE OR PHONE FOR A FREE CATALOGUE

**CMD MICRO**  
COMPUTER SERVICES LTD.

10447 - 124 STREET  
EDMONTON, ALBERTA  
T5N 1R7  
PHONE 403 - 488-7109

\*TRS-80 IS A TRADEMARK OF TANDY CORP.

```

598 PRINT"BASKET GOOD, FOUL ON S
HOT":SOUND150,4
600 F$=D$:GOSUB7000
604 K=1:GOSUB4000
606 IFRB=1THEN520
610 GOTO872
615 'NG, FOUL
618 PRINT"SHOT MISSED, FOUL ON S
HOT"
619 IFO$=A$THENBF=BF+1ELSEAF=AF+
1
623 F$=D$:GOSUB7000
627 K=2:GOSUB4000
629 IFRB=1THEN520
633 GOTO872
640 'DEF FOUL
641 GF=0:S=0:SS=SS-1
643 GOSUB2500:IFCL THEN930ELSEGO
SUB2550
644 PRINT"DEFENSE FOUL BEFORE SH
OT"
646 F$=D$:GOSUB7000:GOSUB9
648 IFT=0THEN654
650 AF=AF+1
652 IFVA>4+N1 THEN663ELSE660
654 BF=BF+1
656 IFVB>4+N1 THEN663
660 PRINTO$" BALL OUT OF BOUNDS"
:TN=0:IFCP>2THEN662
    
```

# AARDVARK LTD.

## NOW THE BEST COST LESS



**DUNGEONS OF DEATH** - A serious role playing game for up to 6 players. You get a choice of race and characters that grow from game to game. You also get a graphic maze and a 15 page manual.

Available On: TRS80C 16K EXT., CMD64, VIC20 13K, IBMPC, TRS80C 32K, MC10 16K

TAPE \$14.95

DISK \$19.95



**QUEST** - A different kind of Graphic Adventure, it is played on a computer generated maze of Alesia. You'll have to build an army and feed them through combat, bargaining, exploration of ruins and temples, and outright banditry! Takes 2 - 5 hours to play and is different each time.

Available On: TRS80C 16K, CMD64, VIC20 13K, MC10 16K, T199 (EXT. BASIC), IBMPC

TAPE \$14.95

DISK \$18.95



**WIZARDS TOWER** - A fantasy game played on a map of forests and dungeons - with dragons and wizards to kill. Similar to QUEST and fun for adults, but a little simpler and playable for the younger set (8 - 60).

Available On: TRS80C 16K EXT., CMD64, VIC20 13K, T199, IBMPC

TAPE \$14.95

DISK \$19.95



**BAG-IT-MAN** - The ultimate arcade game for TRS80C or MCD64. This one has three screens full of BAGS OF GOLD, CARTS & ELEVATORS TO RIDE IN, MINE SHAFTS, and TWO NASTY GUARDS. Great sound and color and continuous excitement.

Available On: TRS80C 32K, CMD64

TAPE \$19.95

DISK \$24.95



**STARFIRE** - If you enjoyed Star Raiders or Star Wars, you will love Starfire. It is not a copy, but the best shoot-em-up, see them in the window space game on the CMD64 or TRS80C. The fantastic graphics will put you right in the control room as you hyperspace from quadrant to quadrant fighting the aliens and protecting your bases.

Available On: TRS80C 16K, CMD64

TAPE \$19.95

DISK \$24.95



**PYRAMID** - ONE OF THE TOUGHEST ADVENTURES. Average time through the pyramid is 50 - 70 hours. Clues are everywhere and some ingenious problems make this popular around the world.

Available On: TRS80C 16K, CMD64, MC10 16K, TIME-X, IBM PC, T199, VIC20 13K

TAPE \$14.95

DISK \$19.95

AARDVARK offers over 120 original high quality programs. Send one dollar for a current catalog and receive a \$1.00 gift certificate good towards your next purchase.

Authors - AARDVARK pays top dollar for high quality programs. Send a copy today for a personal review and editorial help.

TO ORDER: Send amount indicated plus \$2.00 shipping, per order. Include quantity desired and your preference of tape or disk. Be sure to indicate type of system and amount of memory. When using charge card to order by mail, be sure to include expiration date.



CHARGE CARDS  
WELCOME



# 1-313-669-3110

PHONE ORDERS ACCEPTED  
8:00 a.m. to 8:00 p.m. E.S.T., MON-FRI

AARDVARK *Action Software*

2352 S. COMMERCE • WALLED LAKE, MI 48088 • (313) 669-3110

CMD64 / TRS80C / IBMPC / VIC20 / T199

TABLE 2

**Others**

MM	Minutes
SS	Seconds
BA/BB	Rebound factors
BG	Ball out of bounds to defense flag
CC	Drive flag
CL	Clock flag
CP	Mode of play
CQ	Length of possession
D	Defense factor
DL	Delay
DV	In-the-lane counter
E	Time to switch mode of play
F	Random number
FF	Offense factor
FG	Computer ball control flag
G	Defense selection; rebound factor
GF	Go for ball flag
GU	Guarded/open flag
H	Foul on shot flag
J	Free throw missed flag
K	Number of free throws to shoot

**Variables**

**Arrays**

G(1)	Defense number
S(1)	Score
Y\$(4)	Names of defenses
Z\$(1)	Names of defenses in use

**Ratings**

OA/OB	Outside shooting
IA/IB	Inside strength
DA/DB	Defense
QA/QB	Quickness

**Statistics**

AU/BU	Field goals attempted
AV/BV	Field goals made
AW/BW	Free throws attempted
AX/BX	Free throws made
AR/BR	Rebounds
AF/BF	Fouls
AT/BT	Turnovers
VA/VB	Fouls in half
L	Work variable
M	Range limit
N	Work variable
NI	Factor for I-and-I
PC	Factor to limit shooting percentage
PN	Press option
Q	Quickness factor
R	Rebound factor
RA	Range from basket
RB	Defense rebound flag
S	Offense choice
ST	Stall flag
T	Team on offense
TT	Team on defense
TN	Turnover flag
W, X, Y	Free throw totes
X	Also work variable
WB	Man with ball flag
XX	Counter for defense option
Z	Play mode to switch to

**Strings**

A\$/B\$	Team names
AA\$/BB\$	Names plus scores
D\$	Team on defense
F\$	Team committing foul
GU\$	Guarded/open readout
H\$	Period
J\$	Input/variable
LV\$	Level (high school or college)
O\$	Team on offense
PN\$	Input variable (press)
Q\$	Input variable
S\$	Input variable (space=shoot)

**SOFTWARE-HARDWARE**

FOR RADIO SHACK'S TRS-80 MODEL 1/3  
TRS-80 COLOR COMPUTER

**•SEND FOR FREE CATALOG•**

**UTILITY PROGRAMS ON CASSETTE**

SU-1 CASSETTE COPY	\$ 10.00	SPECIFY
SU-2 CASSETTE DUMP	\$ 10.00	COMPUTER

**Y-PAK**

TRS-80 COLOR COMPUTER



TURN YOUR COMPUTER INTO A  
2-SLOT SYSTEM. SWITCH  
BETWEEN THE TWO WITH EASE.

**RECORDER STAND**



MADE OF STURDY PLASTIC.  
HOLDS RECORDER AT A  
PERFECT ANGLE.

RAM/ROM USER-PAK FOR TRS-80 COLOR \$30

**•GAMES ALSO AVAILABLE•**

B.ERICKSON SOFTWARE · P.O.BOX 11099 · CHICAGO IL 60611

**CALL (312) 276-9712 FOR INFORMATION**

- 661 GOSUB9:GOSUB9
- 662 GOT0180
- 663 K=3:GOSUB4000
- 664 IFRB<>1THEN872
- 666 RB=0:GOT0737
- 675 ' OFF FOUL
- 677 PRINT"OFFENSIVE FOUL"
- 678 BG=1
- 681 F\$=0\$:GOSUB7000
- 683 IF0\$=A\$THEN687
- 685 BF=BF+1:GOT0870
- 687 AF=AF+1:GOT0870
- 700 ' TO



```

704 IFRND(2)=1THENPRINT"BAD PASS
":BG=RND(2)-1:ELSEPRINT"TRAVELIN
G":BG=1
706 IFT=0THENAT=AT+1ELSEBT=BT+1
710 GOT0870
720 'NG,OFF RB
721 IFT THENBU=BU+1ELSEAU=AU+1
722 F=RND(0):IFF<.1THEN825
725 PRINT"SHOT MISSED, RB TO "0$
735 GOSUB9
737 F=RND(0):RB=0
740 IFF>.25THEN770
742 F=RND(0):SS=SS-1:GOSUB2500:I
FCL THEN930
744 PRINT "RB TIPPED UP"
746 IFF<.6THEN760
748 F=RND(0)
749 IFF>.6THEN725
752 GOT0804
760 GOT0577
770 IFT=0THENAR=AR+1ELSEBR=BR+1
772 F=RND(0):IFF>.9THEN780
774 SS=SS-1:GOSUB2500:IFCL THEN9
30
775 RA=RND(4):GU=RND(2):GOSUB9
777 CLS3:GOSUB8400
778 IFS$=" "THEN538
780 SS=SS-RND(3)
782 GOSUB9

```

```

784 GOT0520
790 PRINT"SHOT MISSED":PRINT"RB
OUT OF BOUNDS TO ";:GOSUB9
791 IFT=0THENAU=AU+1ELSEBU=BU+1
792 F=RND(2):IFF=2THEN796
794 PRINTD$:BG=1:GOSUB9:GOT0870
796 PRINT0$:GOSUB9:GOT0180
800 'NG,DEF RB
801 IFT THENBU=BU+1ELSEAU=AU+1
802 F=RND(0):IFF<.1THEN825
804 PRINT"SHOT MISSED, REBOUND T
O "D$
806 F=RND(0):IFT THENAR=AR+1:GOT
0814ELSEBR=BR+1
812 IFF<1+(.4-QB)THEN870ELSE818
814 IFF<1+(.4-QA)THEN870
818 GOSUB5000:GOT0850
825 PRINT"SHOT MISSED, FOUL ON R
EBOUND"
830 F=RND(2):IFF=1THEN646ELSEGOS
UB9:GOSUB9:GOSUB5000:BG=1:GOT064
6
850 'FAST BK
851 S=1:SS=SS-RND(4)
852 PRINT0$" FAST BREAK":GOSUB9
854 GOSUB2500:IFCL=1THEN930
856 F=RND(0):OF=.7:IFF<.3THEN575
ELSE500
870 'WRAP-UP

```

## PARALLEL PRINTER INTERFACE

FOR THE RADIO SHACK COLOR COMPUTER  
AND THE TDP 100

- \* RUN ANY STANDARD PARALLEL PRINTER FROM THE SERIAL I/O PORT
- \* WORKS WITH: EPSON, NEC, CENTRONICS, C-itech, SMITH CORONA, RADIO SHACK, GEMINI, OR ANY STANDARD PARALLEL PRINTER
- \* SWITCH SELECTABLE BAUD RATES FROM 300 to 9600
- \* COMPLETE - ALL CABLES AND CONNECTORS INCLUDED
- \* PRICE: \$69 plus \$3 for shipping and handling. Canadian orders add \$5 for shipping. Michigan residents add 4% sales tax.



## PRINTERS

C-itech PROWRITER ——— \$345  
GEMINI 10X ————— \$285

Plus shipping

CALL FOR PRICES ON OTHER MODELS FROM  
THE ABOVE PRINTER MANUFACTURERS

# BOTEK INSTRUMENTS

313-739-2910

Dealer inquiries invited

4949 HAMPSHIRE  
UTICA, MICHIGAN 48087



# TOM MIX SOFTWARE

TELEX  
706139

• FOR THE COLOR COMPUTER & TDP 100 • 3424 College N.E., Grand Rapids, MI 49505 (616) 364-4791 •

## CU\*BER

32K Mach. Lang.  
\$27.95 TAPE  
\$30.95 DISK



Approaches the excitement and challenges of any Video Arcade. The hazards of CU\*BER are many. Help CU\*BER change the colors on the pyramid while avoiding many of the dangers always present. Vipers, the Nurd, the Dork, bonus points all add up to another exciting release from Tom Mix Software.

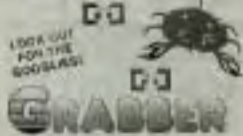

Grabber  
Arcade Action. Method of play you are the Grabber. The object is to grab the 8 treasures and store them in the center boxes. You start with 3 Grabbers and get extra ones at 20,000 points. Watch out for the googlies! Super high resolution graphics.

32K Machine Language  
\$27.95 TAPE \$30.95 DISK



## AIR TRAFFIC CONTROLLER

32K Ext. Basic  
\$28.95 TAPE  
\$31.95 DISK

Air Traffic Controller is a computer model of an air traffic control situation in which Remotely Piloted Vehicles (RPV's) are operated by the controller in landing on and taking off from designated runways.

DEVIL ASSAULT  
16K Machine Language  
\$27.95 TAPE  
\$30.95 DISK



Devil Assault is a multi-level multi-screen game in which bird-like creatures, robots and the devil himself assault your home base which you must defend.

BUZZARD BAIT  
By RUGBY CIRCLE  
32K Machine Language

\$27.95 TAPE \$30.95 DISK

We've done it again! You thought the King was great? wait 'till you see this!! Outstanding high resolution graphics, tremendous sound make this "Joust" type game a must for your software collection. As you fly from cloud to cloud you will enjoy sky high excitement dealing with the challenges presented to you by this newest release by Tom Mix Software.



## JOURNEY TO MT. DOOM

32K Mach. Lang.  
\$27.95 DISK ONLY



The Necromancer is about to wage war on earth. He needs his lost gold ring to acquire the power to do so. You must find the ring, take it to Mt. Doom and destroy it in the flames from which it came, thus eliminating the Necromancer's evil powers.

## "THE FROG"

### \*\*\*ARCADE ACTION\*\*\*

This one will give you hours of exciting play. . . Cross the busy highway to the safety of the median and rest awhile before you set out across the swollen river teaming with hidden hazards. Outstanding sound and graphics.



16K MACHINE LANGUAGE  
\$27.95 TAPE  
\$30.95 DISK

## JUNIOR'S REVENGE

Climb vines, avoid obstacles & creatures to save your father from Luigi.

32K CASS \$28.95

32K DISK \$31.95



## SPACE

## SHUTTLE

\$28.95 TAPE  
\$31.95 DISK

32K Ext. Basic

This program gives you the real feeling of flight. Full instrumentation complete to the max. Actual simulation of space flight. 32K Extended Basic

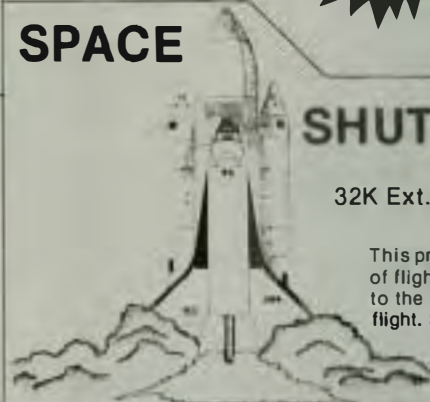

## "TRAPFALL"

By KEN KALISH

### \*\*\*ARCADE ACTION\*\*\*

The "Pitfalls" in this game are many. Hidden treasures, jump over the pits, swing on the vine, watch out for alligators, beware of the scorpion. Another game for the Color Computer with the same high resolution graphics as "The King."



16K MACHINE LANGUAGE  
TAPE \$27.95  
DISK \$30.95

## THE KING

32K Machine Language

\$26.95 TAPE

\$29.95 DISK



ARCADE ACTION - How high can you climb? Four full graphic screens. Exciting Sound - Realistic graphics. Never before has the color computer seen a game like this. Early reviews say: Just like the arcade Simply outstanding!

## OTHER GREAT GAMES

PROTECTORS - Exciting fast paced arcade game that looks and plays like the popular arcade game "DEFENDER".

32K Machine Code Tape \$24.95 Disk \$27.95

COLOR GOLF - Now sit at your computer and play nine or eighteen holes. Outstanding graphics in the fairway or on the green. Helps your game. 32K Extended Basic \$17.95

"YAAZEE" (C) 1983 - Yaazee is a 2 player game using five dice to get the best poker hand. After game is loaded flashing digit below player number determines which player rolls dice at the start of the game. 16K Machine Language Ext. Basic \$19.95

BIRD ATTACK - A fast paced machine language arcade game. Shoot the birdmen before they descend upon you. Watch out for their bombs! 16K Machine Language \$21.95

MAZE RACE - Maze race is a one or two player game. Play either against the built in timer or against your favorite opponent. 16K Machine Code \$17.95



Call our BBS Number  
616-364-8217 24 Hours a Day

ADD \$1.00 POSTAGE & HANDLING • TOP ROYALTIES PAID  
MICHIGAN RESIDENTS ADD 4% SALES TAX • LOOKING FOR NEW SOFTWARE



# TOM MIX SOFTWARE

TELEX  
706139

• FOR THE COLOR COMPUTER & TDP 100 • 3424 College N.E., Grand Rapids, MI 49505 (616) 364-4791 •

NEW

## SR-71

32K Extended Basic

\$28.95 TAPE     \$31.95 DISK

SR-71 is a fast action game in which you are the pilot on a mission to take photographs of missile sites in Russia and deliver them to our processing laboratory in Japan.



## THE KING T-SHIRTS

Limited Edition

Yellow Shirt with Blue Print

ADULTS \$7.95

M - 15 to 15½     L - 16 to 16½

CHILDREN \$7.25

S - 6 to 8     M - 10 to 12     L 14 to 16

\$2.00 Postage & Handling per order



## UTILITIES

**COLOR MONITOR**-Written in position independent code. (May be located in any free memory). Very compact. Only occupies 1174 bytes of memory. Full Featured. Includes Break-Pointing of machine language programs, register display and modify, memory display and modify, and block memory move commands. Displays memory in hex and ascii format on one line 8 bytes long. **MACHINE LANGUAGE \$24.95**

**SCREEN PRINT ROUTINE**-Screen Print Routine Prints contents of your screen to an Epson, Microline or Radio Shack DMP Printers. Prints positive or reverse format. Horizontal or vertical, small and large printout. Print left, right or center of page. **\$19.95**

**DISK TO TAPE**-Dump the contents of most disks to tape automatically. Machine Language. **\$17.95**

**TAPE TO DISK** - Load the contents of most tapes to disk automatically. Machine Language. **\$17.95**

**MAIL LIST**-Maintain a complete mailing list with phone numbers etc. Ext. Basic. DISK BASED **\$17.95**

**PROGRAM PRINTER UTILITY**-This program will list basic programs to your printer in two column format. Saves paper and makes your listing look professional. Disk based. **\$17.95**

## EDUCATIONAL SOFTWARE For The Color Computer and TDP 100



**STORY PROBLEMS** is a program that is designed to give practice in solving STORY PROBLEMS (sometimes called STATEMENT, THOUGHT or WORD PROBLEMS) on the COLOR COMPUTER. It is suitable for use in either a home or school environment. It is also a tool that will allow you to create new story problems to suit your children's needs and ability levels. It has many features that make it particularly attractive: Story problems involving addition, subtraction, multiplication, division or a combination of the four are presented to the student by slowly scrolling each letter of each problem onto the screen. Up to 5 students may use the program at the same time. There are 4, user modifiable, skill levels. **16K Ext. Basic     TAPE \$19.95**

**SPELLING TEST** is designed to give a standard oral spelling test using the audio track of the computer's tape recorder to dictate test words and sample sentences. Student responses are typed on the keyboard and checked by the computer. Results are displayed on the screen and (if connected) on a printer. **REQUIRES 16K EXT. BASIC     \$19.95**

**MATH DRILL** is a program designed to help children to practice addition, subtraction, multiplication, and division skills on the COLOR COMPUTER. It has several features that make its use particularly attractive.

- Up to 6 students may use the program at the same time.
- Answers for addition, subtraction and multiplication are entered from right to left, just as they are written on paper.
- Commas may be included in the answers.
- Partial products for the multiplication problems may be computed on the screen.
- Division answers that have a remainder are entered as a whole number followed by the letter "R" and the remainder.
- There are ten, user modifiable, skill levels.
- A "SMILEY FACE" is used for motivation and reward. Its size increases relative to the skill level.
- Skill levels automatically adjust to the student's ability.
- A timer measures the time used to answer each problem and the total time used for a series of problems.
- After a problem has been answered incorrectly the correct answer appears under (above in division) the incorrect answer.

**REQUIRES 16K EXT BASIC     \$19.95**

**WORD DRILL** is designed to give a multiple choice vocabulary quiz. Words and definitions are entered into the program from the keyboard or from a tape file. The computer displays a randomly chosen definition and eight word choices. The student must enter his response before a built in timer reaches zero.

**REQUIRES 16K EXT. BASIC     \$19.95**

## EDUCATIONAL PACKAGE — SPELLING TEST — WORD DRILL — MATH DRILL — ESTIMATE — ALL FOR — \$69.95

**ESTIMATE** is a program designed to help children to practice estimating the answers to addition, subtraction, multiplication and division problems on the COLOR COMPUTER. It has many features that make its use particularly attractive:

- Up to 5 students may use the program at the same time.
- There are 5, user modifiable, skill levels.
- The acceptable percent error may be changed as a student's skill improves.
- A timer measures the number of seconds used to answer each problem and the total time used for a series of problems.
- If a problem has been answered incorrectly, the student is told the percent error and asked to try again.
- If a problem is answered incorrectly a second time, the student is told the correct answer and the range of acceptable answers is displayed.
- A report is given at the end of each set of problems that includes the number of problems done, the number of problems answered correctly on the first try and the average percent error.
- The (BREAK) key has been disabled so that a child will not inadvertently stop the program from running.

**16K EXT. BASIC     \$19.95**

**TEACHERS' DATABASE** is a program designed to allow a teacher to keep a computerized file of information about his/her students. There are many features that make this program particularly attractive.

- Information on as many as 100 students (or more) may be in the computer at one time.
- Each student may have as many as 20 (or more) individual items of data in his/her record.
- The program will run from cassette or disk.
- Cassette and disk files are completely compatible.
- The program is menu driven.
- Records may be easily changed, deleted, combined or added.
- Information about students may be numerical or text.
- Records may be quickly alphabetized.
- Records may be sorted by various criteria.
- Records may be reordered (ranked) based on test scores or other data.
- Data displayed during a sort may be printed on a printer or saved on disk or cassette as a new file.
- A full statistical analysis of data may be done and sent to the printer.
- Student test scores may be weighted. **32K EXT BASIC TAPE \$39.95     DISC \$42.95**

Call our BBS Number 616-364-8217 24 Hours a Day

• ADD \$1.00 POSTAGE & HANDLING • TOP ROYALTIES PAID •

MICHIGAN RESIDENTS ADD 4% SALES TAX • LOOKING FOR NEW SOFTWARE



```

872 GOSUB5000
880 SS=SS-RND(2):GOSUB2500:IFCL
THEN930
885 GOSUB9000
888 FORN=1TO3:GOSUB9:NEXT
890 IFRB THEN180
920 IFTN=1THEN660
925 IFBG=1THEN1000ELSE1170
930 PRINT"TIME RUNS OUT":CL=0:FO
RL=1TO6:SOUND140,8:NEXT
931 IFLV$="H"THEN950
932 IFH$<>"1ST HALF"THEN936
934 H$="HALFTIME":GOTO44
936 IFS(0)<>S(1)THEN940
938 H$="OVERTIME":MM=5:GOTO44
940 H$="FINAL":GOTO44
950 IFH$="1ST QTR"THENH$="2ND QT
R":GOTO975ELSEIFH$="2ND QTR"THEN
H$="HALF":VA=0:VB=0:GOTO975ELSEI
FH$="HALF"THENH$="4TH QTR":GOTO9
75
960 IFS(0)<>S(1)THEN970
965 H$="OVERTIME":MM=3:GOTO44
970 H$="FINAL":GOTO44
975 MM=8:GOTO44
999 'PRESS
1000 BG=0:F=RND(0)
1001 PRINTD$TAB(11)"FALL BACK(1-
7)":PRINTTAB(11)"PRESS(2-8)":PRI
NTTAB(11)"GO FOR BALL(3-9)":PRIN
TTAB(11)"OR FOUL(4-0)"
1002 IFCP=2ANDT=1THEN1004
1003 IFCP>1GOSUB6100:GOTO1008
1004 FORL=1TO(DL*1.5)
1005 PN$=INKEY$:PN=VAL(PN$)
1006 IFT=1THEN1008
1007 PN=PN-6:IFPN$="0"THENPN=4
1008 IFPN>0ANDPN<5THEN1012
1009 IFCP>1ANDT=0THEN1012
1010 IFCP>2THEN1012
1011 NEXTL:GOTO1170
1012 ONPN GOTO1170,1020,1015,400
1013 GOTO1170
1015 F=RND(6):ONF GOTO1030,1170,
1170
1016 GOTO640
1020 F=RND(0):SS=SS-RND(4)
1023 IFT=0THENQ=QB/10ELSEQ=QA/10
1025 IFF+Q<.95THEN1050
1030 PRINT"BALL KNOCKED AWAY"
1035 IFT=0THENAT=AT+1ELSEBT=BT+1
1040 F=RND(2):IFF=1THEN818
1045 TN=1:GOTO870
1050 IFF>.8THEN640
1170 BG=0:SS=SS-RND(5)
1175 GOSUB2500:IFCL THEN930
1180 PRINTO$" ACROSS CENTER LINE
"
1190 GOTO180
2500 'TIME

```

```

2510 IFMM<=0ANDSS<=0THEN2530
2515 IFSS<0THEN2525
2520 GOTO2535
2525 MM=MM-1:SS=SS+60:GOTO2535
2530 MM=0:SS=0:CL=1
2535 RETURN
2550 PRINT " ";:IFSS>9THENPRINT
USING"##:##";MM,SS ELSEPRINTUSIN
G"##:0#";MM,SS
2560 RETURN
3000 IFT=1THEN3020
3010 IFWB>20THENFF=0A ELSEFF=IA
3015 GOTO3030
3020 IFWB>20THENFF=0B ELSEFF=IB
3030 BA=(IA-((IB+IB+DB)/3))*10
3040 BB=(IB-((IA+IA+DA)/3))*10
3050 RETURN
4000 'FREE THROWS
4001 J$=INKEY$:PRINT"SEE sTATS O
R SHOOT fREE THROWS":FORL=1TO150
:F=RND(0):J$=INKEY$:IFJ$="S"THEN
4003ELSEIFJ$="F"THEN4004ELSENEXT
:GOTO4004
4003 PRINT:GOSUB69
4004 GOSUB9:F=RND(0)
4005 W=1:X=0:Y=0
4023 IFF>.75THEN4029
4025 PRINT:PRINT"FREE THROW GOOD
":SOUND200,1
4027 X=1:Y=1:BG=1:IF K<>1THEN404
0ELSE4092
4029 PRINT"FREE THROW MISSED"
4031 IFK<>2THEN4090
4040 F=RND(0):W=2
4048 IFF>.75THEN4054
4050 PRINT"2ND FREE THROW GOOD":
SOUND200,1
4052 X=X+1:Y=Y+1:BG=1:GOTO4092
4054 PRINT"2ND FREE THROW MISSED
"
4090 J=1
4092 S(T)=S(T)+Y:IFT=0THEN4096
4094 BW=BW+W:BX=BX+X:GOTO4098
4096 AW=AW+W:AX=AX+X
4098 IFJ=1THEN4105
4100 RETURN
4105 J=0:BG=0:F=RND(5)
4110 IFF=3THEN4140
4115 PRINT"REBOUND TO "D$
4120 IFD$=A$THENAR=AR+1ELSEBR=BR
+1
4125 GOTO4160
4140 PRINT"REBOUND TO "O$:RB=1
4150 IFA$=O$THENAR=AR+1ELSEBR=BR
+1
4160 GOSUB9:RETURN
5000 'CHANGE POSSESSION
5001 S$=INKEY$:XX=0
5005 IFT=0THEN5020
5010 O$=A$:T=0:TT=1:D$=B$:GOTO50

```

★ COLOR COMPUTER WORD PROCESSOR ★

# Elite·Word™

Also Available On OS-9

THE SECOND GENERATION WORD PROCESSOR IS NOW ... ELITE·WORD has many new features not found in other word processors for the Color Computer. ELITE·WORD is an all machine language, high performance, Full Screen Editor

which offers an ease of use that is simply incredible. ELITE·WORD also offers a printed output flexibility that can handle your sophisticated home and business applications. ELITE·WORD is waiting to work for you.

## MAJOR Features include:

- ALL Machine Language for speed
- Handsome Vinyl Binder
- Comprehensive Manual Included
- User Friendly (really)
- Top screen line reserved for command prompts, HELP messages, and status information
- Two text entry modes: Insert and Exchange
  - Edit 2 files simultaneously (OS-9 Only)
  - Delete character under cursor
  - Backspace and delete one character
  - Delete entire screen line
  - Rewrite entire screen
  - Page Forward through text
  - Page Backward through text
  - Mark present line for automatic centering on output
  - Insert new text (Insert mode)
  - Type over old text (Exchange mode)
  - Screen Display is 32x19 in normal text editing modes
  - Screen Display is High-Res 64x19 when used to display final text; including page breaks and justification
  - Screen Display in all modes is true Upper/Lower case characters with descenders
  - Over 13.5K file size in 32K machines
  - Continuous memory display
  - Save text file (disk or tape)
  - Load text file (disk or tape)
  - All I/O errors trapped and recoverable
  - Jump to beginning or end of text
  - Find any string of characters in text
  - Global replacement of one string in text for another
- True block-text Move command
- Smooth cursor movement over text in any direction (Including vertical)
- Smooth screen scroll for easier proof reading
- Auto Key-Repeat will automatically repeat any key that is held down
- Easy generation of ASCII files
- VIEW function permits high-res screen display of final text before it's printed; including right-side justification and page breaks
- VARIABLE TEXT MERGE allows for generation of standard form type letters that appear to be personally prepared for each reader
- INCLUDE feature (disk only) permits the inclusion of many other files within one large document. Total document will have sequential page numbering
- From the same minds that brought you ELITE·CALC
- Type ahead keyboard buffer NEVER misses a character
- Optional screen display of all carriage returns <cr>
- Fast Disk I/O ... No loading of overlay files to slow program operation
- User HELP display available
- Automatic screen Word-Wrap; even while inserting new text
  - Block-text move, copy or delete
  - Display/Change default disk drive number (disk only)
  - Display disk directory (disk only)
  - Display Free disk space available
  - Software remembers last file name Saved or Loaded and will write to that file by default if desired
  - Dynamic margin changes within text
  - Select Top margin, Bottom margin, and Page length
  - Choose number of duplicate copies
  - Page Pause, for single sheet users, if desired
  - Optional page numbering begins with any selected page number
  - Printer Font codes are user definable
  - All printer format options may be changed dynamically within text
  - Any string of HEX characters may be imbedded within text to send any special control codes to your printer
  - An Eject (top of form) command may be inserted within text
  - Variable Text Merge symbols may be inserted anywhere within text
  - All machine language; 32K and Extended Basic required for ROM-call routines

## THE BEST FOR ONLY

Specify

Tape	\$59.95
RS Disk	\$59.95
OS-9 Disk	\$79.95
OS-9 & RS Disk	\$109.95

— Shipping from stock NOW

— Dealer Inquiries Invited.

Add \$2 Postage & Handling

PA residents add 6% sales tax

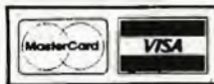

Elite Software

Box 11224 • Pittsburgh, PA 15238 • (412) 795-8492

★ Excellent for Program Editing and Word Processing ★

```

35
5020 D$=B$:T=1:TT=0:D$=A$
5035 CQ=MM:FC=0:S=0:RA=30:DV=0
5040 GOSUB9:IFAV<9ORB<9THENPC=.
5:GOTO5060
5050 IFT=0THENPC=AV/AU ELSEPC=BV
/BU
5060 CLS8:RETURN
6000 L=(RND(0)*.4)-.2:IFT THEN60
20
6005 IFIA<OA+L THENG=1ELSEG=2
6010 IFQB<DB-.1ANDS(1)>S(0) ANDS
(1)<S(0)+8THENG=2
6015 GOTO6050
6020 IFIB<OB+L THENG=1ELSEG=2
6025 IFQA<DA-.1ANDS(0)>S(1)ANDS(
0)<S(1)+8THENG=2
6050 IFCQ-MM>2THENG=1
6060 IFH$<>"2ND HALF"ANDH$<>"4TH
QTR"ANDH$<>"OVERTIME"THENRETURN
6062 IFMM<5ANDS(T)>S(TT)+MM ANDS
(T)-S(TT)<20THENG=1
6065 IF2*MM<S(T)-S(TT)-1AND8+3*M
M>S(T)-S(TT) THENG=3
6070 IFMM=0ANDSS<41ANDS(T)>S(TT)
ANDS(T)-S(TT)<6THENG=3
6080 RETURN
6100 IFF<.6THENPN=1ELSEPN=2
6105 GOSUB6000:IFG=3THENPN=3
6110 RETURN

```

```

6500 GOSUB9:L=FF:S$="":S=0:IFS(T
T)>S(T)+2THEN6520
6501 IFH$<>"2ND HALF"ANDH$<>"4TH
QTR"ANDH$<>"OVERTIME"THEN6510
6505 IFMM<5THENIFS(T)>S(TT)ANDS(
T)-S(TT)<MM+3THENL=.6:FG=1
6510 IFMM=0ANDS(T)=>S(TT)ANDS(T)
-S(TT)<4THENL=.75:FG=1:S=3
6520 IFOF+.06>L THEN6600
6521 IFL<.7THENN=L ELSEN=L-.2
6523 IFOF>=N+(RND(0)*(L-N)) THEN6
600
6525 IFFG THEN6537
6530 IFRA<9ANDRND(RA)=1THEN6600
6537 IFL=.2THEN6560ELSEIFMM=0AND
SS<9THENL=.2:GOTO6520ELSEIFFG TH
EN6560
6540 IFH$<>"2ND HALF"ANDH$<>"4TH
QTR"ANDH$<>"OVERTIME"THEN6560
6550 IFS(TT)-S(T)>MM*2+2THENFG=1
:L=L-.1:GOTO6520
6555 IFL>.599THEN6580
6560 FG=0:IFRA<33ANDGU<1/G(TT)TH
ENS=1:RETURN
6570 IFG(TT)=1ANDRA<18THENIFRND(
3)=2THENS=1:RETURN
6580 RETURN
6600 S$="":S=0:RETURN
7000 'FOUL TOTE
7015 IFF$=A$THEN7050
7020 FB=FB+1:F=FB
7025 VB=VB+1
7027 PRINTB$" WITH"VB"FOULS"
7030 GOSUB7200
7032 IFF<>1THEN7080
7038 F=RND(5)
7040 PRINT"PLAYER "F" FOULS OUT"
7045 IFF<3THENOB=OB-.05ELSEIB=IB
-.05
7047 DB=DB-.05:GOTO7080
7050 FA=FA+1:F=FA
7055 VA=VA+1
7057 PRINT A$" WITH"VA"FOULS"
7060 GOSUB7200
7062 IFF<>1THEN7080
7068 F=RND(5)
7070 PRINT"PLAYER "F" FOULS OUT"
7075 IFF<3THENOA=OA-.05ELSEIA=IA
-.05
7077 DA=DA-.05
7080 IFCP>2THEN7200
7085 GOSUB9:GOSUB9
7200 IFF=20ORF=25ORF=30ORF=35ORF
=40THENF=1ELSEF=0
7202 RETURN
8000 CLS3:IFRA>29ANDRND(5-G(TT))
=3THENRA=RA+RND(6)-3:GU=RND(3):G
OTO8400
8004 ONG(TT)GOTO8200,8010,8300
8010 IFT=0THENQ=QA:D=DB:GOTO8012

```

## TANDY Computers

### TDP 100

Radio Shack \* Compatible

16K	1 FREE Program	149.95
16K EXT	3 FREE Programs	229.95
16K EXT	4 FREE Programs	289.95

1 FREE JOYSTICK with Any of Above

TDP Line Printer 100	239.95
TDP Four Color Graphics Plotter	159.95
Drive 0 Complete (first one)	379.95
Drive 1 (second one)	269.95

TDP or Tandon Drives (your choice)

Any 6 Tandy Programs-240.00 Value	99.95
All 14 Tandy Programs-500.00 Value	189.95
NEW White Keyboard (the new one)	39.95

### ALL TANDY PRODUCTS ARE WHITE

over 125 Different CoCo Programs in Stock  
write for free catalog

Bustout-Space Assault-Polaris-Microbes-Shooting Gallery-Colorfile  
- Reg 29.95 Now 16.95  
Chess-Scrispit-Spectaculator-Personal Finance-Micropainter-Project  
Nebula - Reg 39.95 Now 19.95

Vidiotex w/CompuServe-Learning Lab-Now 24.95 each

901-323-1183  
3422 Plaza

MEMPHIS, TN  
38111



\*Radio Shack & TDP 100 are Trademarks of Tandy Corp

# Elite·Calc™

NOW... The worksheet calculator program you've been waiting for is waiting to work for you. ELITE·CALC™ is a powerful, full featured worksheet calculator designed especially for the Color Computer. Answer "what if" questions, prepare reports,

maintain records and perform other tasks that, until now, required sophisticated business computers. ELITE·CALC™ is a serious tool for those who want to do more than play games with their Color Computer.

## Features include:

- Single character commands
- Help Displays
- Enter text or formulas to 255 characters long
- Repeat text entries
- 255 maximum rows
- 255 maximum columns
- Available memory always displayed
- Rapid Entry modes for text and data
- Selectable Automatic Cursor movement
- Insert, Delete, Move entire rows or columns
- Replicate one cell to fill a row or column with selectable formula adjustment
- All machine language for speed
- Extended BASIC required for ROM routine calls
- Automatic memory size detection for 16K, 32K or 64K
- >20K bytes, storage available in 32K systems
- BASIC style formulas
- Math Operators: +, -, X, /, (, ), =
- Relation Operators: =, >, <, <=, >=, <>
- Logic Operations: AND, OR, NOT
- Conditional Formula: IF ... THEN ... ELSE
- Trig Functions: SIN, COS, TAN, ATN

- EASY TO USE
- INDIVIDUAL CELL FORMULAS
- COPY BLOCKS OF CELLS
- FULL CELL-EDIT CAPABILITY
- COMPATIBLE WITH ALL PRINTERS
- EASY 132 COLUMN PAGE WIDTH
- CHANGEABLE BAUD RATES
- GRAPH FORMAT FOR BAR CHARTS
- SORT IN ASCENDING OR DESCENDING ORDER
- COMPREHENSIVE MANUAL INCLUDED
- NATIONWIDE USER GROUP
- HANDSOME VINYL BINDER

- Log Functions: LOG, EXP, SQR.
  - Misc. Functions: INT, FX, ABS, SGN.
  - Range Functions: SUM, AVERAGE, COUNT, MIN, MAX, LOOKUP
  - Nine digit precision
  - Definable constant table
  - User definable printer set-up commands
  - Individual column width settings
  - Adjustable row height to insert blank lines without wasting memory
  - Hide columns or rows
  - Alternate print font selectable on cell by cell basis
  - Display/Print formats set by cell, row, or column
  - Dollar format, comma grouping; prefix or postfix sign
  - Scientific notation, fixed point and integer formats
  - Left and Right cell contents justification
  - Full page formatting
  - All formats stored with worksheet on disk(tape)
  - Save & Load Disk(tape) files in compact memory form
  - Scan disk directories
  - Output ASCII file for word processor input compatibility
  - Memory resident code ... no repeated disk calls
- Sample worksheets included

THE BEST FOR ONLY

# \$59.95

Specify: **Disk or Tape**  
 -- Shipping from stock NOW  
 -- Dealer Inquiries Invited.  
 Add \$2 Postage & Handling  
 PA residents add 6% sales tax

*Elite Software*

Box 11224 • Pittsburgh, PA 15238 • (412) 795-8492

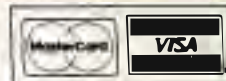

"Elite·Calc is a great spreadsheet program! This professional quality program has the performance required for serious home applications as well as small businesses."

Stuart Hawkinson, Rainbow

"Truly one of the best programs I have seen."

John Steiner, Micro

"Elite·Calc is an extremely powerful worksheet..."

Jack Lane, Color Micro Journal

"Bruce Cook's Elite·Calc is a very fine program indeed; potentially one of the great Color Computer Programs." "... a very impressive product."

Scott L. Norman, Hot CoCo

```

8011 Q=QB:D=DA
8012 IFRA<9THEN8020
8014 RA=RND(D*48)+(D*16)+1
8016 IFRA<17THENRA=9+RND(D*20)
8020 IFRA<14THENRA=RND(D*18)+RND
(D*18):IFRA>16THENRA=14:GOTO8020
8040 IFRA>19THENN=.7:GOTO8075
8045 IFRA>16ANDRA<20THENN=.3ELSE
N=0
8075 SS=SS-RND(2)
8100 GU=RND(0)+D+.1-N+(D-.5)
8110 GOTO8400
8200 IFT=0THENQ=QA:D=(DB+QB)/2:G
OTO8205
8201 Q=QB:D=(DA+QA)/2
8205 IFRA<10THENRA=RND(14)+(D*9)
:GOTO8240
8210 RA=RND(D*44)+(D*13)-(Q*8)
8240 GU=D+RND(0)-.1+(D-.5):GOTO8
400
8300 RA=RND(30):ST=0
8305 IFT THENQ=QB:D=DA ELSEQ=QA:
D=DB
8310 IFRA>27THENRA=RND(4):GU=0:G
OTO8400
8320 GU=RND(2)
8400 IFSS<9ANDMM=0THENS=SS-1ELS
ESS=SS-(RND(5)+1)
8405 IFST=1THENRA=RND(19)+20:ST=
0ELSEIFRA>35THENRA=RA-9
8410 GOSUB2500:IFCL THENRETURN
8414 S#=INKEY$:GOSUB9000
8415 IFCC=1THEN8420
8416 WB=RA+RND(20):IFRA<16THENWB
=WB-7
8420 CC=0:IFWB>20THENPRINT"GUARD
WITH BALL"ELSEPRINT"BIG MAN WIT
H BALL"
8425 IFWB>20ANDRA<11THENGU=GU+.3
8428 GOSUB3000:OF=FF
8430 IFGU>1THENGU$="GUARDED"ELSE
IFGU>.5THENGU$="OPEN"ELSEGU$="WI
DE OPEN"
8440 PRINTINT(RA+.5)"FEET AWAY,
"GU$
8450 IFWB>20THENM=20ELSEM=10
8460 IFRA<M THENOF=OF+(M-RA-5)/1
00:GOTO8470
8465 OF=OF+(M-RA-5)*2/100
8470 IFRA<4THENOF=OF+OF/2
8475 IFGU>1THENOF=OF/2
8480 IFOF<.1THENOF=.1
8485 IFOF>.9THENOF=.9
8487 IFWB<21THEN8490
8488 IFGU>1ANDRA<9THENOF=OF-.1
8490 PRINT:PRINT"PRESS<SPACE> TO
SHOOT"
8491 PRINT" (1-7) TO DRIVE":PRI
NT" (2-8) TO STALL":PRINT" (3-
9) TO PASS":PRINT

```

```

8492 IFCP=1THEN8500
8494 IFCP=2ANDT=0THEN8500
8495 GOSUB6500:GOTO8513
8500 FORL=1TO(DL*1.5)
8510 S#=INKEY$:S=VAL(S$)
8512 IFS=3ORS=9THEN8530
8513 IFS>0THEN8600
8515 IFS$=" "THEN8540
8517 IFCP>2THEN8525
8518 IFCP=2ANDT=1THEN8525
8520 NEXTL
8521 GOTO8530
8525 GOSUB9
8530 DV=0:IFGF=1THEN245
8535 IFST=1THEN510
8540 RETURN
8600 IFS>5THENS=S-6
8605 CC=1:IFS=1THENPRINT"DRIVE":
GOSUB9:GOTO8620
8610 PRINT"STALL":GOSUB9:ST=1:GO
TO8535
8620 IFGU>1THEN8650
8640 X=(Q*8)-(D*8)+RND(5)+(RA/8)
8647 RA=RA-X:GOTO8651
8650 RA=RA-RND(2)+RND(2)
8651 IFRA<8THENDV=DV+1:IFDV>4THE
N8540
8652 IFRA<3THENRA=1+RND(D*8):GU=
GU+.3
8653 GU=GU+(D/1.7)-(RND(0)*(Q/2)
):IFG(TT)=2ANDRA<25THENGU=GU+D
8654 F=RND(0)*8:IFF<(1-D)ANDG(TT
)=1THENGU=D+.2
8655 F=RND(0):IFF<(1-Q)/40THENPR
INT"DOUBLE DRIBBLE":GOTO706
8658 IFF>1-(Q/40)THEN675
8660 SS=SS-RND(3)
8665 CLS3:GOTO8410
9000 PRINTO$" WITH THE BALL"
9001 PRINT"DEFENSE: "Z$(TT)
9005 IFMM<E ANDCP=4THENCP=Z:PRIN
T"TIME TO SWITCH MODES","PRESS e
nter TO CONTINUE":INPUTJ$:CLS3:G
OTO9000
9010 GOSUB2550
9040 PRINTA$"--"S(0):PRINTB$"--"
S(1):PRINT
9060 RETURN
9500 INPUT"PRINT STATS(Y,N)";Q$:
IFQ$="N"THENENDELSEIFQ$<>"Y"THEN
9500
9510 CLS:PR=1:GOSUB60:M=1087
9520 FORI=3TO14:FORL=0TO31
9530 M=M+1:X=PEEK(M):IFX>95THENX
=X-64
9540 IFX<32THENX=X+64
9550 PRINT#-2,CHR$(X);:NEXTL:PRI
NT#-2,CHR$(13);:NEXTI
9560 FORL=0TO9:PRINT#-2,CHR$(13)
:NEXT:GOTO9500

```



# Elite·File™

*THIS IS IT! ELITE•FILE is the full featured, all machine language, Data Base Manager, that Color Computer users have been waiting for. From the same author that brought you ELITE•CALC, ELITE•FILE is for everyone who needs to store and recall information. You specify what to store, and what to retrieve. ELITE•FILE gives you total flexibility. ELITE•FILE is a relational Data Base Manager*

*with all the editing and repeat formatting features that are typically found only on much larger computer systems, but priced for Color Computer users. It's "user friendly" command structure makes it simple to use even for those who don't write computer programs. ELITE•FILE is waiting to work for you.*

**Features include:**

- Compatible with ELITE•CALC and ELITE•WORD ASCII files
- User friendly combination of Menu driven input and single key commands
- Up to 255 named fields per record
- Up to 255 characters per field
- Up to 2000 characters per record
- Up to 4000 records per file
- Supports multiple drives
- Nested subfield definitions
- Up to eight fields in primary key
- Copy record definition from file to file
- View record definition
- Input records with easy to use field name format display
- Edit records with full screen "type over" editor
- Copy records to repeat identical data
- Scan mode for quick data retrieval
- Locate any record by field contents
- Load ELITE•CALC spread sheets into random access data files
- User setable print formats
- TAB, VTAB, CR, PAGE, text, hex print controls
- Join up to four subfile records to extend data record for print
- Create "Variable Text Insert" files for ELITE•WORD
- Produce repetitive reports with Retrieval Programs written on ELITE•WORD
- Refile data into new record structures

- ★ ALL MACHINE LANGUAGE
- ★ FLEXIBLE, USER DEFINED DATA RECORD STRUCTURES
- ★ 16 FILES CAN BE HANDLED AT THE SAME TIME FOR 64K RECORD CAPACITY!
- ★ EDIT, SCAN, SORT, SELECT RECORDS
- ★ OUTPUT REPORTS TO SCREEN, PRINTER, OR ASCII DISK FILE
- ★ PLACE DATA BY FIELD NAME, WITH CUSTOM TEXT, ANYWHERE ON THE PRINTED PAGE
- ★ COMPATIBLE WITH ALL PRINTERS
- ★ COMPREHENSIVE MANUAL
- ★ HANDSOME VINYL BINDER

- Thousands of applications:
  - Mailing List
  - Inventory
  - Record Collection Index
  - Phone Number Reference
  - Order Entry/Invoice
  - Expense Records
  - Recipe Files
  - Study Note Retrieval
  - Customer Files
  - Check Book Register
  - Library Catalog
  - Appointment Calendar
  - Yours
- Data, field definitions, indices stored on a single file
- List disk directories, change default drive and "kill" files without leaving ELITE•FILE
- Memory resident, no program overlays from disk
- Minimum 32K, Disk Basic required
- Single program performs all features
- Data files accessible from BASIC programs
- Project any subset of fields in any order for the printed output
- Select specific records by field content with full logic combination capabilities
- Sort records in ascending or descending order by any field
- Calculate values from combinations of field contents
- Math operators: +, -, \*, /, (, )
- Display or print column totals

THE BEST FOR ONLY

**\$74.50**

- Disk Only
- Shipping NOW
- Add \$2.50 Shipping
- PA residents add 6% sales tax
- Dealer inquiries invited



*Elite Software*

Box 11224 • Pittsburgh, PA 15238 • (412) 795-8492

From the creators of: ZAKSUND • COLOR TEXTSET I • COLOR TEXTSET II • INTER-GALACTIC FORCE • TEXT EDITOR • PARTY PAK • COLOR MONITOR • TREK-16 • WARKINGS • DISK & TAPE COPY • ANIMALS • BODY PARTS • TAPE COPY and many other line programs



# A Complete Character Generator

By Bill Nolan  
Rainbow Contributing Editor

*In the fantasyland of magazine publishing, a columnist becomes trapped in a time warp that serves up a St. Valentine's Day turkey, compresses a contest, and causes dragons and other unlikely characters of old to pour forth from a 20th century machine.*

Welcome to Fantasyland! As you know, there is a contest going on in this column to design spells and monsters for the new fantasy roleplaying game we are creating. The response so far has been excellent, with several really good entries, and we will be announcing the winners in next month's column. If you haven't already entered, it is probably too late now, but if you want to give it a try the rules and prizes are in last month's issue. The reason it's too late is called lead time, and I never appreciated it until lately. The cover of this magazine may say "February," but as I sit here at my trusty CoCo pecking out these immortal words in an effort to beat my deadline, my calendar says that Thanksgiving is just a few days in the future. If sometimes we don't seem as timely as you would like, that is the reason.

This month we are digressing for a bit. A lot of people have written me and asked for a *complete* character generator program to use with Dungeons and Dragons, and so I decided that I would provide the one I use myself. This is a complete package, and lets you create a character that includes basic scores, race, class (or classes), sex, age, height, weight, thieving abilities, clerical spell bonuses, and hit points. Try it out a few times, and I think you will be pleasantly surprised by the accuracy and attention to detail.

By the way, this program rolls up characters for use with fantasy roleplaying games. It isn't a game itself. I say that because lots of people have typed in one of my programs and then called or written to say that they didn't understand how to get the game to start.

Next month we will have the winners in the monsters and spells contest, and we will also continue with the development of our new game — really, I promise. So, until then, you have a nice St. Valentine's day, and I'll go pick out a turkey. I sure am glad I don't really have to take my trusty sword Doomspeaker out and slay my own turkey again this year, but that's another story.

*(Bill Nolan and his wife Sara operate Prickly-Pear Software. Bill also teaches computer science at a local college and is DM at a regular weekly fantasy game.)*

Rainbow  
Check  
Plus

20	0438	117
33	0713	242
45	0953	37
66	0C74	240
81	0E76	242
96	10C8	58
109	12B6	119
127	1541	121
139	170B	157
155	18AE	222
168	1AF2	99
186	1CDE	0
200	1ED0	171
218	21D8	187
231	23DE	66
END	26C3	111

## The listing:

```

1  ******CHARACTER GENERATOR*****
2  ******COPYRIGHT 1982*****
3  *****PRICKLY-PEAR SOFTWARE****
4  CLEAR: DIMC(6), C$(11,2), R$(7,2)
   , MC(3,1), DA(17,7), D(10)
8  GOSUB 199: CLS: PRINT@34, "STRENGT
H  -----": PRINT@52, ST: IFES=1THE
NPRINT@56, "/" ; ER
9  PRINT@98, "INTELLIGENCE ----": PR
INT@116, IN: PRINT@162, "WISDOM ---
-----": PRINT@180, WI: PRINT@226, "
DEXTERITY -----": PRINT@244, DX: P
RINT@290, "CONSTITUTION ----": PRIN
T@308, CN: PRINT@354, "CHARISMA ---
----": PRINT@372, CH
10 PRINT@419, "RECORD THESE IF OK
AND HIT": PRINT@450, "'C' TO GO O
    
```

```

N - 'R' TO RE-ROLL";
11 K$=INKEY$: IFK$="" THEN11ELSESO
UND150,1
12 IFK$<>"C"ANDK$<>"R" THEN11ELSE
IFK$="R" THEN8
13 CLS:GOSUB34:GOSUB62
14 CLS:C$(1,2)="CLERIC": IF (R<>6)
ANDIN>5ANDST>5ANDCN>5ANDCH>5ANDW
I>8THENC$(1,1)="Y"
15 C$(2,2)="DRUID": IF (R<>2) AND (R
<>3) AND (R<>4) AND (R<>7) ANDIN>5AND
ST>5ANDDX>5ANDCN>5ANDWI>11ANDCH>
14THENC$(2,1)="Y"
16 C$(3,2)="FIGHTER": IFST>8ANDCN
>6ANDWI>5ANDDX>5ANDCH>5THENC$(3,
1)="Y"
17 C$(4,2)="PALADIN": IF (R=1) ANDD
X>5ANDST>11ANDIN>8ANDWI>12ANDCN>
8ANDCH>16THENC$(4,1)="Y"
18 C$(5,2)="RANGER": IF (R=10RR=5)
ANDDX>5ANDCH>5ANDST>12ANDIN>12AN
DWI>13ANDCN>13THENC$(5,1)="Y"
19 C$(6,2)="MAGIC-USER": IF (R=10R
R=30RR=5) ANDWI>5ANDCN>5ANDCH>5AN
DIN>8ANDDX>6THENC$(6,1)="Y"
20 C$(7,2)="ILLUSIONIST": IF (R=10
RR=4) ANDST>5ANDWI>5ANDCH>5ANDIN>
14ANDDX>15THENC$(7,1)="Y"
21 C$(8,2)="THIEF": IFST>5ANDIN>5
ANDCN>5ANDCH>5ANDDX>8THENC$(8,1)
="Y"
22 C$(9,2)="ASSASSIN": IF (R<>6) AN
DWI>5ANDCN>5ANDST>11ANDIN>10ANDD
X>11THENC$(9,1)="Y"
23 C$(10,2)="MONK": IF (R=1) ANDIN>
5ANDCH>5ANDST>14ANDWI>14ANDDX>14
ANDCN>10THENC$(10,1)="Y"
24 FORX=1TO10: IFC$(X,1)="Y" THENC
X=CX+1
25 NEXTX: IFCX=0 THENPRINT"THESE S
CORES QUALIFY FOR NOTHING": FORX=
1TO1000: NEXTX: GOTO8
26 C$(11,2)="MULTI-CLASSED": IFCX
>1ANDR<>1 THENC$(11,1)="Y"
27 PRINT"THIS CHARACTER QUALIFIE
S TO BE: ": PRINT: FORX=1TO11: IFC$(
X,1)="Y" THENPRINT"      ";: PRIN
TUSING"##. "; X;: PRINT"      "; C$(X,2)
28 NEXTX: PRINT: INPUT"      ente
r YOUR CHOICE"; CL$: SOUND150,1: MC
(1,0)=VAL(CL$): C=MC(1,0): IFC$(MC
(1,0),1)<>"Y" THENPRINT"      enter a
number shown": FORX=1TO1000: NEXTX
CLS: GOTO27
29 IFMC(1,0)=11 THENGOTO185
30 CL$=C$(MC(1,0),2): NC=1
31 Y=0: FORX=1TONC: IFMC(X,0)=3ORM
C(X,0)=4ORMC(X,0)=5 THENY=Y+1
32 NEXTX: IFY=0ANDES=1 THENES=0: ER
=0

```

```

33 GOTO66
34 PRINT" THESE SCORES QUALIFY T
O BE A: ": R$(1,2)="HUMAN": R$(1,1)
="Y": R$(2,2)="DWARF": IF (ST>7) AND
(CN>10) AND (CH>4) THENR$(2,1)="Y"
35 R$(3,2)="ELF": IF (IN>7) AND (DX>
5) AND (CN>6) AND (CH>7) THENR$(3,1)=
"Y"
36 R$(4,2)="GNOME": IF (ST>5) AND (I
N>6) AND (CN>7) THENR$(4,1)="Y"
37 R$(5,2)="HALF-ELF": IF (IN>3) AN
D (DX>5) AND (CN>5) THENR$(5,1)="Y"
38 R$(6,2)="HALFLING": IF (ST>6) AN
D (IN>5) AND (DX>6) AND (CN>9) THENR$(
6,1)="Y"
39 R$(7,2)="HALF-ORC": IF (ST>4) AN
D (CN>11) THENR$(7,1)="Y"
40 PRINT: FORX=1TO7: IFR$(X,1)="Y"
THENPRINT"      ";: PRINTUSING"#
#. "; X;: PRINT"      "; R$(X,2)
41 NEXTX
42 K$=INKEY$: IFK$="" THEN42
43 SOUND150,1: R=VAL(K$): IFR$(R,1)
<>"Y" THEN42
44 ONR GOTO45,46,49,50,51,52,55
45 R$="HUMAN": RETURN
46 R$="DWARF": CN=CN+1: CH=CH-1: IF
DX>17 THENDX=17
47 IFCH>16 THENCH=16
48 RETURN
49 R$="ELF": DX=DX+1: CN=CN-1: RETU
RN
50 R$="GNOME": RETURN
51 R$="HALF-ELF": RETURN
52 R$="HALFLING": ST=ST-1: ES=0: ER
=0: DX=DX+1: IFWI>17 THENWI=17
53 IFDX>18 THENDX=18
54 RETURN
55 R$="HALF-ORC": ST=ST+1: CN=CN+1
: CH=CH-2: IFIN>17 THENIN=17
56 IFWI>14 THENW=14
57 IFDX>14 THENDX=14
58 IFCH>12 THENCH=12
59 IFST>18 THENST=18: GOTO61
60 IFST=18 THENER=RND(100): ES=1
61 RETURN
62 CLS: PRINT@34,"STRENGTH -----
-": PRINT@52,ST: IFES=1 THENPRINT@5
6,"/"; ER
63 PRINT@98,"INTELLIGENCE ---": P
RINT@116,IN: PRINT@162,"WISDOM --
-----": PRINT@180,WI: PRINT@226,
"DEXTERITY -----": PRINT@244,DX:
PRINT@290,"CONSTITUTION ---": PRI
NT@308,CN: PRINT@354,"CHARISMA --
-----": PRINT@372,CH
64 PRINT: PRINT" RECORD THESE NEW
RACE-ADJUSTED": PRINT"      VALUES
, THEN HIT ANY KEY"
65 K$=INKEY$: IFK$="" THEN65ELSESO

```

```

UND150,1:RETURN
66 CLS:PRINT:PRINT" enter THE L
EVEL AS -:FORX=1TONC:PRINT:PRIN
T" ";C$(MC(X,0),2);:INPUTL$:MC(
X,1)=VAL(L$):SOUND150,1:NEXTX
67 PRINT:PRINT" enter THIS ";R$(
R,2);"'S SEX."
68 PRINT" HIT 'F' OR 'M' PLEASE
"
69 S$=INKEY$:IFS$=""THEN69ELSESO
UND150,1
70 IFS$<>"F"ANDS$<>"M"THEN69ELSE
IFS$="F"THENS$="FEMALE"ELSE$="M
ALE"
71 PRINT:PRINT" enter THE NAME"
:PRINT" ";:INPUTN$
72 CLS:ONCN GOTO73,73,73,74,74,7
4,75,75,75,75,75,75,75,75,76,77,
78,78,78
73 CB=-2:GOTO81
74 CB=-1:GOTO81
75 GOTO81
76 CB=1:GOTO81
77 CB=2:GOTO81
78 FORX=1TONC:IFMC(X,0)=3ORMC(X,
0)=4ORMC(X,0)=5THENGOTO80
79 NEXTX:CB=2:GOTO81
80 IFCN=17THENCB=3ELSEIFCN=18THE
NCB=4ELSEIFCN=19THENCB=5
81 D(1)=8:D(2)=8:D(3)=10:D(4)=10
:D(5)=8:D(6)=4:D(7)=4:D(8)=6:D(9
)=6:D(10)=4
82 FORZ=1TONC:PRINT" ";C$(MC(Z,
0),2);:IFMC(Z,0)=5ORMC(Z,0)=10TH
ENL=MC(Z,1)+1ELSEL=MC(Z,1)
83 FORY=1TOL:RP=RND(D(MC(Z,0))):
PRINTRP;:IFMC(Z,0)=3ORMC(Z,0)=4O
RMC(Z,0)=5THENB6
84 IFCB>2THENRP=RP+2ELSERP=RP+CB
85 GOTO87
86 RP=RP+CB
87 HP=HP+RP:NEXTY:PRINT:NEXTZ:HP
=HP/NC
88 PRINT" CONSTITUTION BONUS ="
;CB
89 PRINT" HIT POINTS =" ;HP
90 IFINT(HP)=HP THEN93ELSEPRINT"
ROUND UP OR DOWN? (U/D)"
91 K$=INKEY$:IFK$=""THEN91ELSESO
UND150,1:IFK$<>"U"ANDK$<>"D"THEN
91ELSEIFK$="D"THENHP=INT(HP)ELSE
HP=INT(HP)+1
92 GOTO89
93 PRINT:PRINT" RECORD THIS, THE
N HIT ANY KEY"
94 K$=INKEY$:IFK$=""THEN94ELSESO
UND150,1
95 CLS:C7=MC(1,0):C8=MC(2,0):C9=
MC(3,0):IFC=11THENGOSUB163:GOTO1
25

```

```

96 AC=MC(1,0):ONR GOTO97,104,107
,111,115,119,122
97 IFAC=1ORAC=2ORAC=8THENAG=18+R
ND(4):GOTO125
98 IFAC=3THENAG=15+RND(4):GOTO12
5
99 IFAC=4THENAG=17+RND(4):GOTO12
5
100 IFAC=5ORAC=9THENAG=20+RND(4)
:GOTO125
101 IFAC=6THENAG=24+RND(8)+RND(8)
:GOTO125
102 IFAC=7THENAG=30+RND(6):GOTO1
25
103 AG=21+RND(4):GOTO125
104 IFAC=1THENAG=250+RND(20)+RND
(20):GOTO125
105 IFAC=3THENAG=40+RND(4)+RND(4)
+RND(4)+RND(4)+RND(4):GOTO125
106 AG=75+RND(6)+RND(6)+RND(6):G
OTO125
107 IFAC=1THENFORX=1TO10:A=RND(1
0):AG=AG+A:NEXTX:AG=AG+500:GOTO1
25
108 IFAC=3THENAG=130+RND(6)+RND(
6)+RND(6)+RND(6)+RND(6):GOTO125
109 IFAC=6THENAG=150+RND(6)+RND(
6)+RND(6)+RND(6)+RND(6):GOTO125
110 AG=50+RND(6)+RND(6)+RND(6)+R
ND(6)+RND(6):GOTO125
111 IFAC=1THENAG=300+RND(12)+RND
(12)+RND(12):GOTO125
112 IFAC=3THENAG=60+RND(4)+RND(4)
+RND(4)+RND(4)+RND(4):GOTO125
113 IFAC=7THENAG=100+RND(12)+RND
(12):GOTO125
114 AG=80+RND(4)+RND(4)+RND(4)+R
ND(4)+RND(4):GOTO125
115 IFAC=1ORAC=2THENAG=40+RND(4)
+RND(4):GOTO125
116 IFAC=3ORAC=5THENAG=22+RND(4)
+RND(4)+RND(4):GOTO125
117 IFAC=6THENAG=30+RND(8)+RND(8)
:GOTO125
118 AG=22+RND(8)+RND(8)+RND(8):G
OTO125
119 IFAC=1THENAG=80+RND(12):GOTO
125
120 IFAC=3THENAG=20+RND(4)+RND(4)
+RND(4):GOTO125
121 AG=40+RND(4)+RND(4):GOTO125
122 IFAC=1THENAG=20+RND(4):GOTO1
25
123 IFAC=3THENAG=13+RND(4):GOTO1
25
124 AG=20+RND(4)+RND(4)
125 PRINT:PRINT" THE AGE IS: ";A
G
126 ONR GOTO127,128,129,130,131,
132,133

```

# The HJL-57 Keyboard



## Compare it with the rest. Then, buy the best.

If you've been thinking about spending good money on a new keyboard for your Color Computer, why not get a good keyboard for your money?

Designed from scratch, the HJL-57 Professional Keyboard is built to unlock ALL the potential performance of your Color Computer. Now, you can do real word processing and sail through lengthy listings...with maximum speed; minimum errors.

At \$79.95, the HJL-57 is reasonably priced, but you can find other CoCo keyboards for a few dollars less. So, before you buy we suggest that you compare.

### Compare Design.

The ergonomically-superior HJL-57 has sculptured, low-profile keycaps; and the three-color layout is identical to the original CoCo keyboard.

### Compare Construction.

The HJL-57 has a rigidized aluminum baseplate for solid, no-flex mounting. Switch contacts are rated for 100 million cycles minimum, and covered by a spill-proof membrane.

### Compare Performance.

Offering more than full-travel, bounce-proof keyswitches, the HJL-57 has RFI/EMI shielding that eliminates irritating noise on displays; and four user-definable function keys (one latchable), specially-positioned to avoid inadvertent actuation.

### Free Function Key Program

Your HJL-57 kit includes usage instructions and decimal codes produced by the function keys, plus a free sample program that defines the function keys as follows: F1 = Screen dump to printer. F2 = Repeat key (latching). F3 = Lower case upper case flip (if you have lower case capability). F4 = Control key; subtracts 64 from the ASCII value of any key pressed. Runs on disc or tape; extended or standard Basic.

### Compare Installation.

Carefully engineered for easy installation, the HJL-57 requires no soldering, drilling or gluing. Simply plug it in and drop it right on the original CoCo

mounting posts. Kit includes a new bezel for a totally finished conversion.

### Compare Warranties.

The HJL-57 is built so well, it carries a full, one-year warranty. And, it is sold with an exclusive 15-day money-back guarantee.

### Compare Value.

You know that a bargain is a bargain only as long as it lasts. If you shop carefully, we think you will agree...the HJL-57 is the last keyboard your CoCo will ever need. And that's **real** value.

### Order Today.

Only \$79.95, the HJL-57 is available for immediate shipment for either the original Color Computer (sold prior to October, 1982) or the F-version and TDP-100 (introduced in October, 1982).

**Order by Phone Anytime**

**716-235-8358**

**24 hours, 7 days a week**



**PRODUCTS INC.**

955 Buffalo Road • P.O. Box 24954  
Rochester, New York 14624

Ordering Information: Specify model (Original or F-version). Payment by C.O.D., check, MasterCard or Visa. Credit card customers include complete card number and expiration date. Add \$2.00 for shipping. New York state residents add 7% sales tax. Dealer inquiries invited.

```

127 HT=68+RND(8):WT=167+RND(16):
GOTO134
128 HT=45+RND(6):WT=142+RND(16):
GOTO134
129 HT=56+RND(8):WT=96+RND(8):GO
TO134
130 HT=39+RND(6):WT=76+RND(8):GO
TO134
131 HT=62+RND(8):WT=122+RND(16):
GOTO134
132 HT=33+RND(6):WT=56+RND(8):GO
TO134
133 HT=62+RND(8):WT=142+RND(16)
134 PRINT:PRINT" THE HEIGHT IS";
HT:PRINT:PRINT" THE WEIGHT IS";W
T:PRINT:PRINT" RECORD THESE VALU
ES, THEN"
135 PRINT" HIT ANY KEY TO CONTIN
UE"
136 K$=INKEY$:IFK$=""THEN136ELSE
SOUND150,1
137 IFC7=8ORC8=8ORC9=8THEN141
138 IF(C7=9ANDMC(1,1)>2)OR(C8=9A
NDMC(2,1)>2)OR(C9=9ANDMC(3,1)>2)
THEN141
139 IFC7=10ORC8=10ORC9=10THEN141
140 GOTO142
141 GOSUB206
142 CLS:Y=0:FORX=1TONC:IFMC(X,0)
=1THENY=Y+1
143 NEXTX:IFY=0THEN155
144 IFWI<13THEN155
145 PRINT"      **CLERIC SPELL BON
US**":PRINT:W9=WI-12:ONW9 GOTO15
1,150,149,148,147,146
146 PRINT" 1 FOURTH LEVEL"
147 PRINT" 1 THIRD LEVEL"
148 PRINT" 1 SECOND LEVEL"
149 PRINT" 1 SECOND LEVEL"
150 PRINT" 1 FIRST LEVEL"
151 PRINT" 1 FIRST LEVEL
152 PRINT:PRINT" ALL ARE CUMULA
TIVE"
153 PRINT:PRINT" RECORD THIS IN
FORMATION,":PRINT" THEN HIT ANY
KEY."
154 K$=INKEY$:IFK$=""THEN154ELSE

```

```

SOUND150,1
155 CLS
156 PRINT" THIS CONCLUDES THE GE
NERATION":PRINT" OF THIS CHARACT
ER"
157 PRINT:PRINT" ";N$:PRINT" ";R
$:PRINT" ";CL$:PRINT" LEVEL(S) "
;:FORX=1TONC:PRINT" -";:PRINTMC(
X,1);" ";:NEXTX:PRINT
158 PRINT" HIT POINTS =";HP:PRIN
T" AGE =";AG;" HEIGHT =";HT:PRI
NT" WT. =";WT;" STR. =";ST;:IFES
=1THENPRINT"/";ER ELSEPRINT
159 PRINT" INTEL. =";IN;" WISDO
M =";WI:PRINT" DEX. =";DX;" CON
ST. =";CN:PRINT" CHARISMA =";CH;
" SEX = ";S$
160 PRINT@480,"HIT ANY KEY";:K$=
INKEY$
161 K$=INKEY$:IFK$=""THEN161ELSE
SOUND150,1:GOTO 4
163 ONR GOTO164,164,167,171,175,
179,182
164 IFC7=10RC8=10RC9=1THENAG=290
:RETURN
165 IFC7=8ORC7=9ORC8=8ORC8=9ORC9
=8ORC9=9THENAG=93:RETURN
166 AG=60:RETURN
167 IFC7=10RC8=10RC9=1THENAG=600
:RETURN
168 IFC7=6ORC8=6ORC9=6THENAG=180
:RETURN
169 IFC7=3ORC8=3ORC9=3THENAG=160
:RETURN
170 AG=80:RETURN
171 IFC7=10RC8=10RC9=1THENAG=336
:RETURN
172 IFC7=7ORC8=7ORC9=7THENAG=124
:RETURN
173 IFC7=8ORC7=9ORC8=8ORC8=9ORC9
=8ORC9=9THENAG=100:RETURN
174 AG=80:RETURN
175 IFC7=10RC7=20RC8=10RC8=20RC9
=10RC9=2THENAG=48:RETURN
176 IFC7=6ORC8=6ORC9=6THENAG=46:
RETURN
177 IFC7=8ORC7=9ORC8=8ORC8=9ORC9
=8ORC9=9THENAG=46:RETURN
178 AG=34:RETURN
179 IFC7=20RC8=20RC9=2THENAG=92:
RETURN
180 IFC7=8ORC8=8ORC9=8THENAG=48:
RETURN
181 AG=32:RETURN
182 IFC7=8ORC7=9ORC8=8ORC8=9ORC9
=8ORC9=9THENAG=28:RETURN
183 IFC7=10RC8=10RC9=1THENAG=24:
RETURN
184 AG=17:RETURN
185 PRINT"      HOW MANY CLASSES

```

**NEW**      \*\*\* COCO - BINGO \*\*\*

FOR THE COCO, TDP100, AND DRAGON

- \* UNLIMITED NUMBER OF PLAYERS
- \* COLOR GRAPHICS & SOUND
- \* BALL COUNT & PAUSE FEATURE
- \* BINGO CARDS & CHIPS INCLUDED
- \* DISK COMPATABLE
- \* 16K EXT. CASSETTE ----- \$12.95



RAINBOW  
CERTIFICATION  
SEAL

COLORTECH SYSTEMS  
17401 DARTMOUTH AVE.  
CLEVELAND, OHIO 44111

INCLUDE \$1.50 P/H  
OHIO RES. ADD 6.5% TAX

# FINALLY!

## A REAL SPREAD-SHEET PROGRAM FOR THE COLOR COMPUTER

# DYNACALC™

Business people use spread-sheets to organize columns and rows of figures. DYNACALC simulates the operation of a spread-sheet without the mess of paper and pencil. Of course, corrections and changes are a snap. Changing any entered value causes the whole spread-sheet to be re-calculated based on the new constants. This means that you can play, 'what if?' to your heart's content.

But DYNACALC isn't just for accountants. DYNACALC can be used for just about any type of job. Not only numbers, but alphanumeric messages can be handled. Engineers and other technical users will love DYNACALC's sixteen-digit math and built-in scientific functions. There's even a built-in sort command, so you can use DYNACALC to manage small data bases - up to 256 records.

DYNACALC will let your computer do just about anything you can imagine. Ask your friends who have VisiCalc, or a similar program, just how useful an electronic spread-sheet program can be for all types of household, business, engineering, and scientific applications.

DYNACALC is designed to be used by non-programmers, but even a Ph.D. in Computer Science can understand it. Built-in HELP messages are provided for quick reference to operating instructions.

DYNACALC has a beautifully simple method of reading and writing FLEX data files, so you can communicate both ways with other programs on your system, such as the Text Editor, Text Processor, Sort/Merge, RMS data base system, or other programs written in BASIC, C, PASCAL, FORTRAN, and so on.

Except for a few seldom-used commands, DYNACALC is memory-resident, so there is little disk I/O to slow things down. The whole data array (worksheets) is in memory, so access to any point is instantaneous. DYNACALC is 100% 6809 machine code for blistering speed.

Color Computer DYNACALC works with the FLEX operating system from Frank Hogg Laboratory (64k required). If you aren't already using this powerful operating system, we have a special deal for you: order DYNACALC (regularly \$200) and FHL Color FLEX (regularly \$99) together for only \$250.

To order, see your local DYNACALC dealer, or order directly from CSC at the address below. We accept telephone orders from 10 am to 6 pm, Monday through Friday. Call us at 314-576-5020. Your VISA or MasterCard is welcome. Be sure to specify that you want the Color Computer version.

## ORDER YOUR DYNACALC TODAY!

Computer Systems Center  
13461 Olive Blvd.  
Chesterfield, MO 63017  
(314) 576-5020



```

?"
186 K$=INKEY$:IFK$=""THEN186ELSE
SOUND150,1
187 NC=VAL(K$):IFNC<20RNC>CX ORN
C>3THEN186
188 FORX=1TONC
189 PRINT@449,"      ENTER CLASS #
";X
190 K$=INKEY$:IFK$=""THEN190ELSE
SOUND150,1
191 MC(X,0)=VAL(K$):IFC$(MC(X,0)
,1)<>"Y"THEN190
192 IFX=1THEN197
193 ONX GOTO197,194,195
194 IFMC(X,0)=MC(1,0)THEN189ELSE
196
195 IFMC(X,0)=MC(1,0)ORMC(X,0)=M
C(2,0)THEN189ELSE196
196 CL$=CL$+"/"+C$(MC(X,0),2):GO
TO198
197 CL$=C$(MC(X,0),2)
198 PRINT@470,"*";MC(X,0);"*":FO
RXX=1TO500:NEXTXX:SOUND150,1:NEX
TX:GOTO66
199 FORC=1TO6:C(C)=0:ES=0:ER=0:F
ORC=1TO6:D1=RND(6):D2=RND(6):D3=
RND(6):D4=RND(6)
200 IF(D1=<D2)AND(D1=<D3)AND(D1=
<D4)THENC(C)=D2+D3+D4:GOTO204
201 IF(D2=<D1)AND(D2=<D3)AND(D2=
<D4)THENC(C)=D1+D3+D4:GOTO204
202 IF(D3=<D1)AND(D3=<D2)AND(D3=
<D4)THENC(C)=D1+D2+D4:GOTO204
203 C(C)=D1+D2+D3
204 NEXTC:ST=C(1):IN=C(2):WI=C(3
):DX=C(4):CN=C(5):CH=C(6):IFST=1
8THENES=1:ER=RND(100)
205 RETURN
206 IFMC(1,0)=10THENL=MC(1,1):GO
TO211
207 FORX=1TONC:IFMC(X,0)=8THENL1
=MC(X,1):GOTO210
208 NEXTX:FORX=1TONC:IFMC(X,0)=9
THENL2=(MC(X,1)-2):GOTO210
209 NEXTX
210 IFL1>L2 THENL=L1 ELSEL=L2
211 CLS:PRINT"      ***JUST A MO
MENT***":FORX=1TO17:FORY=0TO7:RE
ADDA(X,Y):NEXTY:NEXTX
212 PP=DA(L,0):OL=DA(L,1):FT=DA(
L,2):MS=DA(L,3):HS=DA(L,4):HN=DA
(L,5):CW=DA(L,6):RL=DA(L,7)
213 D=DX:IFD>18THEND=18
214 D=D-8:OND GOSUB222,223,224,2
25,226,226,226,227,228,229
215 ONR GOSUB226,216,217,218,219
,220,221:GOTO230
216 OL=OL+10:FT=FT+15: CW=CW-10:R
L=RL-5:RETURN
217 PP=PP+5:OL=OL-5:MS=MS+5:HS=H

```

```

S+10:HN=HN+5:RETURN
218 OL=OL+5:FT=FT+10:MS=MS+5:HS=
HS+5:HN=HN+10:CW=CW-15:RETURN
219 PP=PP+10:HS=HS+5:RETURN
220 PP=PP+5:OL=OL+5:FT=FT+5:MS=M
S+10:HS=HS+15:HN=HN+5:CW=CW-15:R
L=RL-5:RETURN
221 PP=PP-5:OL=OL+5:FT=FT+5:HN=H
N+5:CW=CW+5:RL=RL-10:RETURN
222 PP=PP-15:OL=OL-10:FT=FT-10:M
S=MS-20:HS=HS-10:RETURN
223 PP=PP-10:OL=OL-5:FT=FT-10:MS
=MS-15:HS=HS-5:RETURN
224 PP=PP-5:FT=FT-5:MS=MS-10:RET
URN
225 MS=MS-5:RETURN
226 RET
226 RETURN
227 OL=OL+5:RETURN
228 PP=PP+5:OL=OL+10:MS=MS+5:HS=
HS+5:RETURN
229 PP=PP+10:OL=OL+15:FT=FT+5:MS
=MS+10:HS=HS+10:RETURN
230 CLS:PRINT@5,"**THIEVING ABIL
ITIES**":IFMC(1,0)<>10THENPRINT
@67,"PICK POCKETS ---- ";PP
231 PRINT@99,"OPEN LOCKS -----
";OL
232 PRINT@131,"FIND TRAPS -----
";FT
233 PRINT@163,"MOVE SILENTLY ---
";MS
234 PRINT@195,"HIDE IN SHADOWS -
";HS
235 PRINT@227,"HEAR NOISE -----
";HN
236 PRINT@259,"CLIMB WALLS -----
";CW
237 IFMC(1,0)<>10THENPRINT@291,"
READ LANGUAGES -- ";RL
238 PRINT@353,"RECORD THESE, THE
N HIT ANY KEY":
239 K$=INKEY$:IFK$=""THEN239ELSE
SOUND150,1:RETURN
240 DATA 30,25,20,15,10,10,85,0,
35,29,25,21,15,10,86,0,40,33,30,
27,20,15,87,0,45,37,35,33,25,15,
88,20,50,42,40,40,31,20,90,25,55
,47,45,47,37,20,92,30,60,52,50,5
5,43,25,94,35
241 DATA 65,57,55,62,49,25,96,40
,70,62,60,70,56,30,98,45,80,67,6
5,78,63,30,99,50,90,72,70,86,70,
35,99,1,55,100,77,75,94,77,35,99
,2,60,105,82,80,99,85,40,99,3,65
,110,87,85,99,93,40,99,4,70,115,
92,90,99,99,50,99,5,75
242 DATA 125,97,95,99,99,50,99,6
,80,125,99,99,99,99,55,99,7,80

```





## NEW GOOD STUFF FOR EVERY COLOR COMPUTER

Turn your Color Computer into a graphic design center with the ease of a keystroke! **MagiGraph** makes it simple to create highly detailed figures up to and including an entire high-resolution screen. Designed for those with some experience in Basic and Assembly Language programming, **MagiGraph** includes lots of special features:

- A full set of logical and pixel manipulation functions simplifies the development of complex figures.
- An editor lets you zoom in and work on every detail of your design. Toggle between the "macro" and "micro" screens for perspective on your creations.
- Nine animation buffers allow you to preview each sequence to ensure continuity and smooth flow.
- Versatile I/O routines store a graphic screen on cassette or floppy disk; recall it later for use by another program or revise it with **MagiGraph**.

If you're looking for the finest graphic development utility available for your Color Computer, THIS IS IT. Maximize your machine's potential, while you push your imagination to the limit — with **MagiGraph**!

By Kevin Dooley. Cassette **\$34.95** (16K required); Disk **\$39.95** (32K Extended Color BASIC required); Amdisk cartridge **\$44.95**.

### STOP WAITING AROUND FOR THE PRINTER!

**SAVE TIME!** Use the Micro Works **CSPPOOL** printer spooler. Say you've just finished editing a five-page letter to the IRS and you start printing it out. Now you need to run your personal finance program to find out if you'll be able to afford to eat next month, but you have to WAIT for the @#!\* PRINTER! **CSPPOOL** will let you KEEP COMPUTING while your printer is PLODDING. **CSPPOOL** uses only 20 bytes of Basic's memory yet gives you 32K of printer buffer. It's like having two computers for the price of one! Even better yet, **CSPPOOL** can be yours for FREE! When you buy your 64K RAM UPGRADE KIT from The Micro Works, we'll GIVE you a copy of this great little program for FREE! Or we will sell it to you, on cassette or diskette, for only **\$19.95**. Requires 64K. Not for FLEX or OS9.

**64K MEMORY UPGRADE KIT:** For Rev. levels E, ET, NC, TDP-100s, and Color Computer II. Eight prime 64K RAM chips, instructions, and **CSPPOOL**: **\$64.95**.

### SYSTEMS SOFTWARE

**MACRO-80C: DISK-BASED EDITOR, ASSEMBLER AND MONITOR**—With all the features the serious programmer wants, this package includes a powerful 2-pass macro assembler with conditional assembly, local labels, include files and cross referenced symbol tables. **MACRO-80C** supports the complete Motorola 6809 instruction set in standard source format. Incorporating all the features of our Rompack-based assembler (**SDS-80C**), **MACRO-80C** contains many more useful instructions and pseudo-ops which aid the programmer and add power and flexibility. The screen-oriented editor is designed for efficient and easy editing of assembly language programs. **MACRO-80C** allows global changes and moving/copying blocks of text. You can edit lines of assembly source which exceed 32 characters. **DCBUG** is a machine language monitor which allows examining and altering of memory, setting break points, etc.

Editor, assembler and monitor—along with sample programs—come on one Radio Shack compatible disk. Extensive documentation included. By Andy Phelps. **\$99.95**

**SDS-80C: SOFTWARE DEVELOPMENT SYSTEM**—Our famous editor, assembler and monitor in Rompack. Like **MACRO-80C**, it allows the user to write, assemble and debug assembly language programs with no reloading, object patching or other hassles. Supports full 6809 instruction set. Complete manual included. **\$89.95**

**MICROTEXT: COMMUNICATIONS VIA YOUR MODEM!** Now you can use your printer with your modem! Your computer can be an intelligent printing terminal. Talk to timeshare services or to other personal computers; print simultaneously through a second printer port; and re-display text stored in memory. Download text to Basic programs; dump to a cassette tape, or printer, or both. **Microtext** can be used with any printer or no printer at all. It features user-configurable duplex/parity for special applications, and can send any ASCII character. You'll find many uses for this general purpose module! **ROMPACK** includes additional serial port for printer. **\$59.95**

### MICRO WORKS COLOR FORTH

- Faster to program in than Basic
- Easier to learn than Assembly Language
- Executes in less time than Basic

The **MICRO WORKS COLOR FORTH** is a Rompack containing everything you need to run Forth on your Color Computer. **COLOR FORTH** consists of the standard Forth Interest Group (FIG) implementation of the language plus most of **FORTH-79**. It has a super screen editor with split screen display. Mass storage is on cassette. **COLOR FORTH** also contains a decompiler and other aids for learning the inner workings of this fascinating language. It will run on 4K, 16K, and 32K computers. And **COLOR FORTH** contains 10K of ROM, leaving your RAM for your programs! There are simple words to effectively use the Hi-Res Color Computer graphics, joysticks, and sound.

Includes a 112-page manual with a glossary of the system-specific words, a full standard FIG glossary and complete source listing.

**MICRO WORKS COLOR FORTH ... THE BEST!** From the leader in **FORTH**, Talbot Microsystems. **\$109.95**

### MACHINE LANGUAGE

**MONITOR TAPE:** A cassette tape which allows you to directly access memory, I/O and registers with a formatted hex display. Great for machine language programming, debugging and learning. It can also send/receive RS232 at up to 9600 baud, including host system download/upload. 19 commands in all. Relocatable and reentrant. **CBUG TAPE:** **\$29.95**

**MONITOR ROM:** The same program as above, supplied in 2716 EPROM. This allows you to use the entire RAM space. And you don't need to reload the monitor each time you use it. The EPROM plugs into the Extended Basic ROM Socket or the Romless Pack I. **CBUG ROM:** **\$39.95**

**SOURCE GENERATOR:** This package is a disassembler which runs on the Color Computer and generates your own source listing of the BASIC interpreter ROM. Also included is a documentation package which gives useful ROM entry points, complete memory map, I/O hardware details and more. A 16K system is required for the use of this cassette. **80C Disassembler:** **\$49.95**

### HARDWARE

**PARALLEL PRINTER INTERFACE**—Serial to parallel converter allows use of all standard parallel printers. **P180C** plugs into the serial output port, leaving your Rompack slot free. You supply the printer cable. **P180C:** **\$59.95**

**SUPER-PRO KEYBOARD**—**\$69.95** (For computers manufactured after Oct. 1982, add \$4.95)

**ROMLESS PACKS** for your custom EPROMS — call or write for information.

### BOOKS

**6809 ASSEMBLY LANGUAGE PROGRAMMING**, by Lance Leventhal, **\$16.95**

**TRS-80 COLOR COMPUTER GRAPHICS**, by Don Inman, **\$14.95**

**ASSEMBLY LANGUAGE GRAPHICS FOR THE TRS-80 COLOR COMPUTER**, by Don Inman, **\$14.95**

**STARTING FORTH**, by L. Brodie, **\$17.95**

### GAMES

**ZAXXON**—The real thing. Excellent. What more can we say? Cassette requires 32K. **\$39.95**

**STAR BLASTER**—Blast your way through an asteroid field in this action-packed Hi-Res graphics game. Available in **ROMPACK**; requires 16K. **\$39.95**

**PAC ATTACK**—Try your hand at this challenging game by Computerware, with fantastic graphics, sound and action! Cassette requires 16K. **\$24.95**

**HAYWIRE**—Have fun zapping robots with this Hi-Res game by Mark Data Products. Cassette requires 16K. **\$24.95**

**ADVENTURE**—*Black Sanctum* and *Calixto Island* by Mark Data Products. Each cassette requires 16K. **\$19.95** each.

**CAVE HUNTER**—Experience vivid colors, bizarre sounds and eerie creatures as you wind your way through a cave maze in search of gold treasures. This exciting Hi-Res game by Mark Data Products requires 16K for cassette version. **\$24.95**

**THE MICRO WORKS**

California Residents  
add 6% Tax

P.O. Box 1110  
Del Mar, CA 92014  
(619) 942-2400

Master Charge/Visa and  
COD Accepted

# Cheapstick — A Smooth, Rugged Joystick For Less Than \$10

By J.D. German

If your Color Computer joysticks have as many miles on them as mine do, they probably suffer from the same malady — mechanical backlash caused by wear and stretching of the plastic guides inside the mechanism. Backlash is the name engineers give to looseness or play between moving parts, and is a major design problem in mechanisms like steering systems, radio tuning dials, and gear systems. In your joystick, backlash makes playing those high resolution arcade games a very frustrating experience, because you cannot get the fine control you need. Until now, the solution has been to buy a new set of Radio Shack joysticks every 100,000 alien spacecraft or so, or to spend \$40 to \$60 for a joystick based on a high-quality mechanism like those used in radio control transmitters. But, if you are moderately handy with a drill and a soldering iron, and you have an hour to spare, you can make a smooth, accurate joystick for less than \$10.

All the parts you will need for this joystick (which I call *Cheapstick* for obvious reasons) come from the same people who sold you your old, worn out joystick; Radio Shack. Unfortunately (for us), Radio Shack does not sell the joystick plugs or cables. But if you are building your *Cheapstick* as a replacement for a worn out joystick, you can use the cable from it. If not, you might have some luck finding a plug at a local electronic parts store. Ask for a five pin male DIN connector with a 240 degree pin spread. You may wish to take your old one along to be sure of a match.

All of the other parts you will need, along with the Radio Shack part numbers, are shown on the parts list. The total price for these parts as listed in the latest Radio Shack catalog is \$8.52. If you want to substitute parts from your junkbox or a source other than Radio Shack, any joystick mechanism with 100K potentiometers, any normally-open momentary contact switch, and any box that will hold them both will do.

To prepare the box for mounting the joystick and switch, you will need to make two holes in the box and five holes in the cover. The holes in the box are for the cable and the

switch, and are located as shown in Figure 1. These locations were selected on the basis of my own personal preference and could easily be changed to suit yours. The holes in the cover are laid out as shown in Figure 2. The large hole can be made easily with a  $\frac{7}{8}$  inch round chassis punch, but a large drilled hole followed by some fancy work with a file will also do the job. If you use the file method, trace the  $\frac{7}{8}$  inch circle onto the aluminum cover with carbon paper so you will know when to quit filing.

After you have finished making the holes, you are ready to install the cable; but a word of caution here. If you are using the cable from an old joystick, cut off the portion that was inside the joystick box. The cable is often damaged by flexing at the point of entry, causing an intermittent open circuit in one or more of the wires. Before installing the cable, strip the sheath from the last three inches of the loose end, but be careful not to cut the insulation on any of the wires just beneath the sheath. Then strip the insulation from the last  $\frac{1}{4}$  inch of the five wires and tin them by briefly heating them with a soldering iron while applying a little solder. Finally, install one of the small strain-relief bushings four inches from the cable end and push the bushing into the cable hole in the box. The large end of this bushing goes on the outside of the box. The last step before wiring the joystick is to mount the switch in its hole with the hardware provided.

The new joystick, with its all-metal mechanism and wide stop collar, is a great improvement over the old Color Computer joystick and should withstand many times the abuse without developing backlash. The wiring is quite simple if you follow the drawing in Figure 3. First, solder the white and black jumper wires in place from pot terminals V1 to H3 and from H1 to V3, and then solder a 2-inch long black wire to terminal V1. You can use pieces of wire from the cut off end of the old cable for this if you avoid the sections that were pinched where they enter the box. Finally, solder the five wires from the cable to the pot and switch terminals as shown, and solder the black wire from terminal V1 to the other switch terminal. Be sure to follow the wire color coding shown in the figure or your pac clone will become very confused, and there are some wrong connections that could damage the power supply in your computer.

After you attach the joystick mechanism to the box cover and put the cover on the box, you are ready for a test flight. Since the new mechanism is so smooth, it will take you a game or so to get used to it, but once you do, your scores,

*(J.D. German, a private consultant, has authored several educational programs which are marketed through his consulting firm, Creative Technical Consultants. He has degrees in physics and electrical engineering and is a former associate professor at the U.S. Air Force Academy.)*

and your enjoyment, should reach new highs.

If you would like to simplify the construction of your *Cheapstick*, you can order a complete pre-drilled and punched kit including cable and instructions for \$14.95 from Creative Technical Consultants, P.O. Box 652, Cedar Crest, NM 87008.

### Parts List

Part	Radio Shack P/N	Price
Experimenter Box	270-231	\$1.69
100K Joystick Pot	271-1705	4.95
Switch, N.O. Momentary Contact	275-1566	1.19
Strain Relief Bushings	278-1636	.69
Plug, 5 pin, 240° DIN	These items are not available from Radio Shack. Use parts from old joystick or find at other electronics parts store.	
Cable, 5 cond. #22 insulated wire		

All the above items may be purchased in kit form with instructions from Creative Technical Consultants, P.O. Box 652, Cedar Crest, NM 87008. Price: \$14.95, shipping and handling included.

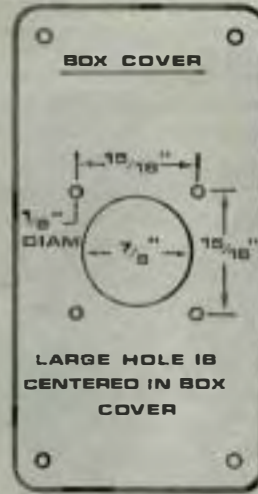

Figure 1

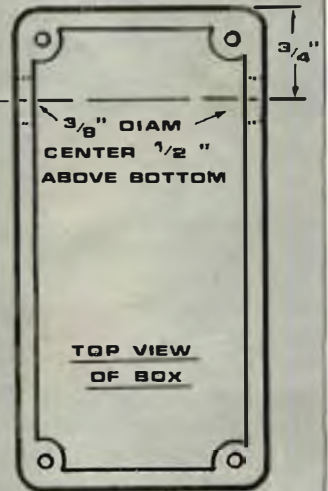

Figure 2

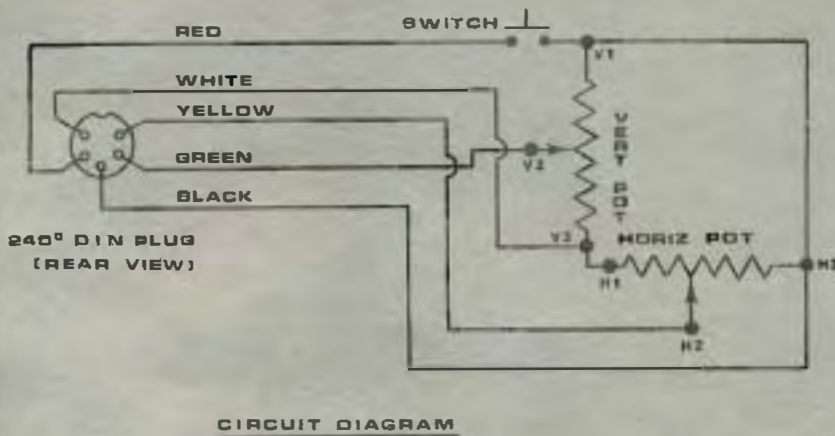

Figure 4

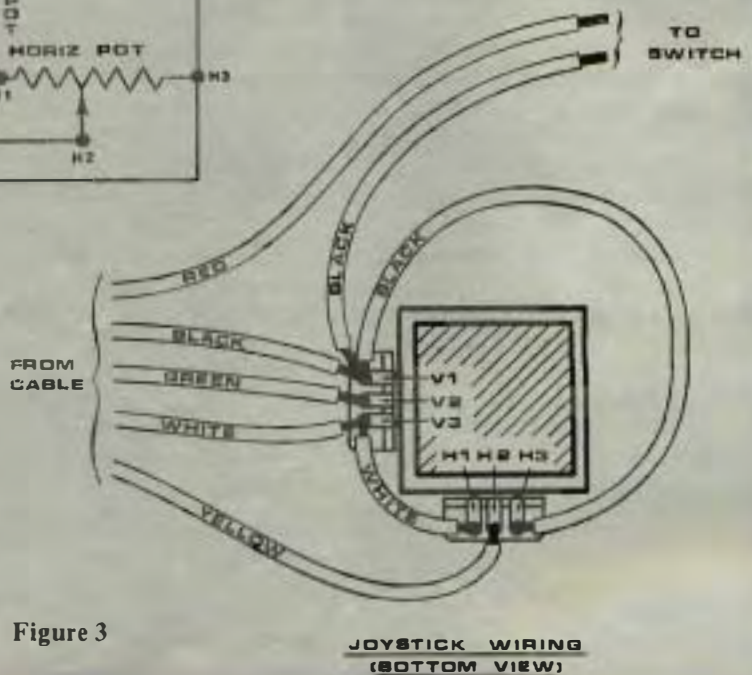

Figure 3

This month I would like to present a simple assembly language utility to make your BASIC programming just a little bit easier. Are you interested? It will work on any Color Computer with at least 4K. Disk drives and Extended Color BASIC are strictly optional.

Introducing *Keyboard Shorthand*. This is a short routine that you load in from tape or disk when you first turn on your computer. It modifies the keyboard control system so that each of the alphabetic keys A to Z has a special abbreviation. To invoke that particular abbreviation, just hold down the arrow key and hit the proper letter key. For example, holding down the down arrow and pressing G will cause the word GOSUB to appear on the screen. This will have the exact same effect as pressing each of the keys individually: G-O-S-U-B.

Each of the 26 alphabetic keys has one such abbreviation, and you may easily redefine them however you like. (We'll talk more about that later.) So, writing a BASIC program with *Keyboard Shorthand* becomes quicker because you have to hit a lot fewer keys. Also, you will be able to cut down on the number of errors due to misspelled BASIC statements.

The source code for *Keyboard Shorthand* is shown in the listing. You may enter it on any standard editor assembler package, such as Radio Shack's *EDTASM+*. The code as shown is for a 32K system. If you have 16K, change the ORG statement to \$3E00. If you have 4K, change it to \$E00.

Once you have finished entering the source code, check your work for typographical errors. Then assemble it onto tape or disk. Finally, save the source code to tape or disk as well. This is done just in case you ever wish to make any modifications at some time in the future.

Now, you are ready to program in BASIC with *Keyboard Shorthand*. Turn on your computer and enter the command `CLEAR 200,32256`. This tells BASIC to leave a certain area of memory alone. This area will be used by *Keyboard Shorthand*. If you have a 16K system, enter `CLEAR 200,15872`. If you have a 4K system, `CLEAR 200,3584`.

Next, load in *Keyboard Shorthand* and EXEC it. BASIC's OK prompt will immediately reappear, and everything will seem to function normally. Indeed, everything will function normally, until you hold down the down arrow key.

Holding down the down arrow key tells *Keyboard Shorthand* to do its thing. If you then press an alphabetic key, the corresponding abbreviation will appear on the screen instead of just the usual letter.

Holding down the down arrow key and pressing [ENTER] will cause a list of all the alphabetic keys and their abbreviations to be displayed. This is handy if you forget for a moment which key does what. The prompt "Press Enter to Continue" will appear at the bottom of the screen under the abbreviations list. Pressing [ENTER] will cause the screen to clear and OK to appear in the upper left corner. Please note that if you were in the midst of entering a program line, it will be lost.

*(Roger Schrag, currently studying computer science at the University of California at Berkeley, enjoys working with the CoCo and writing articles for the Rainbow. He also designs and translates programs for Adventure International.)*

# MULTIPLY YOUR EFFORTS WITH THIS KEYBOARD SHORTHAND

BY ROGER SCHRAG

# NEW!

**TANDON DISK  
DRIVES**

*only*

# \$159.00

**WITH CASE &  
POWER SUPPLY**

**\$189.95**



**TM100**

Speed 5ms tk to tk  
Capacity 250k unformatted  
Tracks 40  
Warranty 6 months

ORDER TOLL FREE!  
1-800-635-0300



Even more savings!!

ALL DRIVES FULLY TESTED & WARRANTEED

- Complete Disk Drive with PS & Case ..... (Tandon) ..... \$189.95
- Two Drives in Dual Case & PS ..... (Tandon) ..... \$359.00
- 1/2 ht double sided double density Disk Drives (Shugart) ..... \$239.95
- 1/2 ht double sided double density Disk Drive with ps & case ..... \$289.95
- Single ps & case ..... \$39.95
- Dual ps & case ..... \$69.95

### Color Computer Controller

Supports double sided double density drives  
with 1 year warranty and manual. ....

\$139.95

### Ask about our 3way Color Computer Drive Kits

- Complete with Diskettes ..... starting at \$329.95
- Diskettes with FREE library case ..... \$19.95
- Head Cleaner Kits ..... \$Call
- Unadvertised Specials ..... \$Call
- Drives cleaned, aligned & tested ..... \$29.95



TECHNICAL STAFF ON DUTY, PLEASE CALL FOR ASSISTANCE.

**CALL US TODAY!!**

**(617)234-7047**

\*DEALER INQUIRIES INVITED



**TRUE DATA PRODUCTS**

195 Linwood Street, P.O. Box 546  
Linwood, Massachusetts 01525

(617) 234-7047

HOURS MON-SAT 9-6 (EST)

We welcome

- Visa / Master Charge
- Checks (allow 2 weeks for clearing)
- C.O.D. Add \$2.00



```

00100 *****
00110 * KEYBOARD SHORTHAND *
00120 *****
00130 *
00140 *BY:
00150 * ROGER SCHRAG
00160 * 2054 MANNING AVENUE
00170 * LOS ANGELES, CA 90025
00180 *
00190 *

```

7E00

```

00200 ORG $7E00 COMPLETELY RELOCATABLE
00210 *
00220 *TABLE OF ABBREVIATIONS. ZERO SEPARATES ENTRIES
00230 *

```

```

7E00 00 00240 TABLE FCB 0 STARTS WITH A ZERO
7E01 41 00250 FCC *AND*
7E04 00 00260 FCB 0
7E05 47 00270 FCC *GOTO *
7E0A 00 00280 FCB 0 B
7E0B 43 00290 FCC *CONT*
7E0F 00 00300 FCB 13 CARRIAGE RETURN
7E10 00 00310 FCB 0 C
7E11 44 00320 FCC *DIR*
7E14 00 00330 FCB 0
7E15 45 00340 FCC *EDIT *
7E1A 00 00350 FCB 0 E
7E1B 46 00360 FCC *FOR *
7E1F 00 00370 FCB 0 F
7E20 47 00380 FCC *GOSUB *
7E26 00 00390 FCB 0 G
7E27 4C 00400 FCC *LOADM*HIRES*
7E33 00 00410 FCB 0 H
7E34 49 00420 FCC *INPUT *
7E3A 00 00430 FCB 0 I
7E3B 45 00440 FCC *ELSE *

```

```

7E40 00 00450 FCB 0 J
7E41 4B 00460 FCC *KILL *
7E47 00 00470 FCB 0 K
7E48 4C 00480 FCC *LOAD *
7E4E 00 00490 FCB 0 L
7E4F 50 00500 FCC *PRINT MEM*
7E5B 00 00510 FCB 13 CARRIAGE RETURN
7E59 00 00520 FCB 0 M
7E5A 4E 00530 FCC *NEXT *
7E5F 00 00540 FCB 0 N
7E60 4F 00550 FCC *OR*
7E62 00 00560 FCB 0 O
7E63 50 00570 FCC *POKE *
7E68 00 00580 FCB 0 P
7E69 53 00590 FCC *STRING$(#
7E71 00 00600 FCB 0 Q
7E72 52 00610 FCC *RUN*
7E75 00 00620 FCB 13 CARRIAGE RETURN
7E76 00 00630 FCB 0 R
7E77 53 00640 FCC *SAVE *
7E7D 00 00650 FCB 0 S
7E7E 50 00660 FCC *PEEK(
7E83 00 00670 FCB 0 T
7E84 20 00680 FCC * USING*
7E8A 00 00690 FCB 0 U
7E8B 4F 00700 FCC *OPEN *
7E91 00 00710 FCB 0 V
7E92 43 00720 FCC *CLOSE*
7E97 00 00730 FCB 0 W
7E98 4C 00740 FCC *LEFT$(#
7E9E 00 00750 FCB 0 X
7E9F 4D 00760 FCC *MID$(#
7EA4 00 00770 FCB 0 Y
7EA5 52 00780 FCC *RIGHT$(#
7EAC 00 00790 FCB 0 Z
00800 *

```

# TRS-80 COMPUTER DISCOUNTS

## COLOR COMPUTERS

26-3026 16k color II	139.95
26-3027 16k ext color II	210.00
26-3003 64k color comp	259.95
26-3022 1st disk drive	329.95
26-3023 2nd disk drive	229.95

## PRINTERS

26-1253 DMP-100	220.00
26-1254 DMP-200	510.00
26-1255 DMP-120	395.00
26-1257DWP-210	629.95

## MODEL 4 and 100's

26-1067 mod 4 16k	829.95
26-1069 mod 4 64k 2 dr.	1695.00
26-3801 mod 100 8 k	699.95
26-3802 mod 100 24k	839.95



**We Carry the Complete Line of TRS-80  
Computer Products at Discount Prices**  
**CALL FOR A FREE PRICE LIST 800-257-5556**  
**IN N.J. CALL 609-769-0551**

## WOODSTOWN ELECTRONICS

Rt. 40 E. WOODSTOWN, N.J. 08098

```

00810 *VARIABLES
00820 *
7EAD 00 00830 STATUS FCB 0 IF AN ABBREVIATION IS IN PROGRESS
7EAE 0000 00840 PNTR FDB 0 WHICH ABBREVIATION IS BEING USED
00850 *
00860 *THE NEW INPUT FROM DEVICE ROUTINE
00870 *
7E80 96 6F 00880 INPUT LDA $6F INPUTTING FROM KEYBRD?
7E82 27 03 00890 BEQ KEYBRD USE NEW ROUTINE IF SO
7E84 12 00900 ROM NOP GO BACK INTO ROM ROUTINE
7E85 12 00910 NOP (AT START CODE IS PUT
7E86 12 00920 NOP HERE IN PLACE OF NOPS)
00930 *
00940 *WHEN BASIC WANTS KEYBOARD INPUT, CONTROL GOES TO
00950 *THE KEYBRD ROUTINE
00960 *
7E87 34 15 00970 KEYBRD PSHS X,B,CC SAVE REGISTERS
7E89 0F 70 00980 CLR $70 CLEAR ROM'S FLAG
7E8B BD A199 00990 WAIT JSR $A199 FLASH CURSOR
7E8E 8D 0D 01000 BSR GETKEY STROBE KEYBOARD
7EC0 27 F9 01010 BEQ WAIT WAIT UNTIL KEY PRESSED
7EC2 C6 60 01020 LDB $60 ERASE THE CURSOR
7EC4 E7 9F 008B 01030 STR [$8B] FROM THE SCREEN
7ECB 35 15 01040 PULS CC,B,X RESTORE REGISTERS
7ECA 32 62 01050 LEAS 2,S CLEAN UP STACK
7ECC 39 01060 RTS RETURN
01070 *
01080 *GETKEY ROUTINE STROBES THE KEYBOARD AND RETURNS
01090 *ASCII CODE OF KEY PRESSED. IT DIFFERS FROM THE
01100 *ROM ROUTINE AT [$A000] IN THAT IT HANDLES THE 26
01110 *ABBREVIATIONS.
01120 *
7ECD 34 10 01130 GETKEY PSHS X SAVE X REGISTER
7ECF 6D 8C DB 01140 TST STATUS,PCR SKIP AHEAD IF AN ABBREV-
7ED2 26 30 01150 BNE DOWORD IATION IS IN PROGRESS
7ED4 AD 9F A000 01160 JSR [$A000] SCAN KEYBOARD
7ED8 34 03 01170 PSHS A,CC SAVE REGISTERS
7EDA B6 0156 01180 LDA $156 IS THE DOWN ARROW KEY
7EDD 84 08 01190 ANDA $88 BEING HELD DOWN?
7EDF 26 35 01200 BNE EXIT EXIT IF NOT
7EE1 35 03 01210 PULS A,CC A CONTAINS KEY PRESSED
7EE3 34 03 01220 PSHS A,CC PUT REGISTERS BACK
7EE5 81 0D 01230 CMPA $80D ENTER KEY PRESSED?
7EE7 27 31 01240 BEQ LIST IF SO, PRINT UP LIST
7EE9 80 41 01250 SUBA $841 A LETTER KEY PRESSED?
7EEB 25 29 01260 BLD EXIT EXIT IF NOT
7EED 81 18 01270 CMPA $81B ...
7EEF 24 25 01280 BHS EXIT ...
7EF1 32 62 01290 LEAS 2,S CLEAN UP STACK
7EF3 30 8D FF09 01300 LEAX TABLE,PCR TABLE OF ABBREVIATIONS
7EF7 6D 80 01310 FINDIT TST ,X+ ZERO MARKS END OF EACH
7EF9 26 FC 01320 BNE FINDIT SKIP THRU WHOLE ABBREV
7EFB 4A 01330 DECA SKIP AS MANY ABBREVS
7EFC 2A F9 01340 BPL FINDIT AS NECESSARY
7EFE AF 8C AD 01350 STX PNTR,PCR SAVE THE LOCATION
7F01 6C 8C A9 01360 INC STATUS,PCR SET WORD STATUS
01370 *
01380 *PROCESS AN ABBREVIATION, WHETHER JUST STARTED OR
01390 *ALREADY IN PROGRESS. ONE CHARACTER AT A TIME
01400 *
7F04 AE 8C A7 01410 DOWORD LDX PNTR,PCR GET LOCATION OF ABBREV
7F07 A6 80 01420 LDA ,X+ GET NEXT CHARACTER
7F09 AF 8C A2 01430 STX PNTR,PCR SAVE NEW LOCATION
7F0C 6D 84 01440 TST ,X END OF ABBREVIATION?
7F0E 26 03 01450 BNE NOTEND SKIP AHEAD IF NOT
7F10 6F 8C 9A 01460 CLR STATUS,PCR RESET WORD STATUS
7F13 4D 01470 NOTEND TSTA SETM THE FLABS
7F14 35 90 01480 PULS X,PC RESTORE & RETURN
7F16 35 03 01490 EXIT PULS A,CC GET THE KEY PRESSED
7F18 35 90 01500 PULS X,PC RESTORE & RETURN
01510 *
01520 *LIST ALL KEYS AND THEIR ABBREVIATIONS
01530 *
7F1A BD A928 01540 LIST JSR $A928 CLEAR SCREEN
7F1D BE 0420 01550 LDX $420 PUT CURSOR NEAR
7F20 9F 88 01560 STX $88 TOP OF SCREEN
7F22 30 8D FEDB 01570 LEAX TABLE+1,PCR ABBREVIATIONS LIST
7F26 86 41 01580 LDA $841 START WITH "A" KEY
7F28 34 02 01590 LI PSHS A SAVE THE KEY DONE NOW

```

```

7F2A 8D 3C 01600 BSR VIDEO PRINT IT ON SCREEN
7F2C 86 3A 01610 LDA $3A A COLON
7F2E 8D 38 01620 BSR VIDEO PRINT IT ON SCREEN
7F30 86 20 01630 LDA $20 A SPACE
7F32 8D 34 01640 BSR VIDEO PRINT IT ON SCREEN
7F34 A6 80 01650 L2 LDA ,X+ GET A CHARACTER
7F36 27 0A 01660 BEQ L4 SKIP IF END OF ABBREV
7F38 81 20 01670 CMPA $20 IS IT A PRINTABLE CHR?
7F3A 24 02 01680 BHS L3 SKIP AHEAD IF SO
7F3C 8A 80 01690 ORA $80 MAKE IT A GRAPHICS CHR
7F3E 8D 28 01700 L3 BSR VIDEO PRINT THE CHARACTER
7F40 20 F2 01710 BRA L2 LOOP BACK FOR REST
7F42 DC 88 01720 L4 LDD $88 GET CURSOR POSITION
7F44 C4 F0 01730 ANDB $F0 REPOSITION IT TO THE
7F46 C3 0010 01740 ADDD $10 NEXT COLUMN/LINE
7F49 DD 88 01750 STD $88 SAVE NEW POSITION
7F4B 35 02 01760 PULS A RESTORE KEY COUNT
7F4D 4C 01770 INCA GO TO NEXT KEY
7F4E 81 5A 01780 CMPA $5A ARE WE ALL DONE?
7F50 23 D6 01790 BLS L1 LOOP BACK IF NOT
7F52 30 8D 001C 01800 LEAX PROMPT,PCR *PRESS ANY KEY*
7F56 A6 80 01810 L5 LDA ,X+ GET A CHARACTER
7F58 27 04 01820 BEQ L6 SKIP AHEAD IF END
7F5A 8D 0C 01830 BSR VIDEO PRINT CHARACTER
7F5C 20 FB 01840 BRA L5 LOOP BACK FOR REST
7F5E AD 9F A000 01850 L6 JSR [$A000] SCAN KEYBOARD
7F62 27 FA 01860 BEQ L6 WAIT FOR A KEY
7F64 6E 9F FFFE 01870 JMP [$FFFE] RETURN TO BASIC
01880 *
01890 *ROUTINE TO PRINT ON SCREEN
01900 *
7F68 34 16 01910 VIDEO PSHS A,B,X SAVE REGISTERS
7F6A 0F 6F 01920 LDA $6F SELECT DEVICE ZERO
7F6C AD 9F A002 01930 JSR [$A002] PRINT ON SCREEN
7F70 35 96 01940 PULS X,B,A,PC RESTORE & RETURN
01950 *
01960 *MESSAGE PRINTED AT BOTTOM OF LIST
01970 *
7F72 0D 01980 PROMPT FCB I3 CARRIAGE RETURN
7F73 50 01990 FCC $PRESS ANY KEY TO CONTINUE#
7F8C 00 02000 FCB 0 END OF MESSAGE
02010 *
02020 *CODE BELOW PATCHES THE NEW KEYBOARD DRIVER
02030 *INTO OPERATION
02040 *
7F8D 34 12 02050 START PSHS X,A SAVE REGISTERS
7F8F B6 016A 02060 LDA $16A GET THE CURRENT INPUT
7F92 BE 016B 02070 LDX $16B FROM DEVICE HOOK
7F95 AF 8D FF1B 02080 STA ROM,PCR PUT IT INTO THE NEW
7F99 AF 8D FF1B 02090 STX ROM+1,PCR INPUT ROUTINE
7F9D 86 7E 02100 LDA $97E DPCODE FOR *JMP NN*
7F9F 30 8D FF0D 02110 LEAX INPUT,PCR WHERE TO JUMP TO
7FA3 B7 016A 02120 STA $16A PATCH IN OUR NEW
7FA6 BF 016B 02130 STX $16B INPUT ROUTINE
7FA9 6F 8D FF00 02140 CLR STATUS,PCR CLEAR WORD STATUS
7FAD 35 92 02150 PULS A,X,PC RESTORE & RETURN
02160 *
7FBD 02170 START
00000 TOTAL ERRORS

```

## NOT FOR THE TIMID!

Jade Products presents **Kingshield**—the fantasy-adventure game of skill and cunning now available for the 32K Extended Color Computer.

As challenging as any mainframe game, as convenient as your T.V. Battle dwarves, dragons, panthers, and more as you explore the king's labyrinth in search of the fabulous shield!

To purchase your program tape, send your check or money-order for \$18.95 to:

**Jade Products**  
**519 N. Scott**  
**Wheaton, IL 60187**

Ill. residents add  
 5 1/4% sales tax





# DESERT SOFTWARE

*Quality Products at Prices You Can Afford*

## PRICKLY-PEAR SOFTWARE

### Omni Clone

This is a must program for anyone with a disk system. It allows the user to back up any disk protected or not.

### Prickly-Pear Mailing List\*

Maintain up to 1500 records on disk. Full upper and lowercase on your choice of green or white background. \*Disk and 32K req.

### Preread 1, 2 & 3

Designed to meet the needs of parents having children just beginning to read.

### Music Box

A 100% machine language program that will allow you to EASILY compose your favorite song in FOUR PART HARMONY.

## PETROCCI FREELANCE ASSOCIATES

### Forcaster & Weather Watch

This one's on disk and a real must if you're into forecasting your own weather. Can be used by Science teachers to help teach students how weather is forecast. 32K and Disk req.

### Heart-Lung & Circulatory Sys.

Another one for the class room. Teaches the student about various parts of the body.

### Pre-School Pack

This is a set of four programs designed to prepare the pre-schooler for kindergarden. Each program is sold separately at \$9.95 each. They include ABC's, 1 2 3, BIG BIGGER BIGGEST, and SHAPES. Very well thought out and in Pmode 3 with colors.

LIST

D/S

\$39.95

\$33.95

\$49.95

\$42.45

\$24.95

\$21.95

\$24.95

\$21.95

\$49.95

\$42.95

\$34.95

\$29.95

\$24.95

\$21.95

## KRT SOFTWARE

### F-16 Fighter

This is the best flight simulator we've seen yet. It comes in either a 16K or 32K version and takes full advantage of Pmode 4 graphics. If you're a pilot you won't want to miss this one at a steal of a price.

LIST

D/S

\$19.95

\$16.95

## ILLUME DESIGN

### Stars

See the night sky on your TV. Stars, Constellation, and Planets. Educational and entertaining.

### Electronic Drafting Board

Create complex designs, label components, and print finished design. 64K and Disk req.

### Geneology

Perform geneological searches. Categories: Family and given names date and place of birth, marriage and death, father, mother, and spouse references. Various print-outs, etc. 32K and Disk req.

\$14.95

\$12.95

\$39.95

\$33.95

\$29.95

\$25.95

## CLASSICAL COMPUTING, INC.

### Speak Up!!

This is a Voice Synthesizer that will knock you off your feet. Type in a word and CoCo will say it. At last a good way to generate speech without investing an arm and a leg.

\$29.95

\$25.95

## SKYLINE SOFTWARE

### MDISK

This is the best program we've found to access the Upper 32K when you have 64K RAMS installed.

\$27.95

\$24.95

### WE'RE DEALERS ALSO FOR THE FOLLOWING COMPANIES:

Mark Data, Tom Mix, B5 Software Co., VIP Software, Eigen Systems, Sugar Software, Soft Sector Marketing DSL Software, Aardvark, Data Soft, Frank Hogg, and many more.

### WRITE FOR OUR FREE CATALOG LISTING

All programs are 16K Extended except where noted,  
all programs are on cassette for Disk orders please add \$5.00 extra.

**Terms:** Cash, Money Order, or your personal checks welcome. Please allow two weeks to clear your check. Shipping \$2.50 on prepaid orders. Please add \$3 extra for hardware. Arizona residents please add 5% sales tax. All programs — 16K ext. except where noted. We reserve the right to change prices without notice.

**Warranty:** All hardware products are warranted for a period of 180 days from date of purchase. Software is warranted as per its manufacturers warranty. We shall not be liable for loss or damage, alleged or caused indirectly or directly to hardware or software including interruption of service, business loss, loss of expected profits or any damage resulting from the use of hardware or software.

## DESERT SOFTWARE

4321 W. Jupiter • Tucson, Arizona 85741 • (602) 744-1252

# RAINBOW Info

## How To Read Rainbow

Please note that all the BASIC program listings you will find in *the Rainbow* are formatted for a 32-character screen — so they will show up just as they do on your CoCo screen. One easy way to check on the accuracy of your typing is to compare what character “goes under” what. If the characters match — and your line endings come out the same — you have a pretty good way of knowing that your typing is accurate.

We also have “key boxes” to show you the *minimum* system a program needs. But, *do* read the text before you start typing.

Finally, the little cassette symbol on listings indicates that program is available through our *Rainbow On Tape* service. An order form for this service is on the insert card bound in the magazine.



## The Rainbow Seal

The Rainbow Certification Seal is our way of helping you, the consumer. The purpose of the Seal is to certify to you that any product which carries the Seal has been physically seen by us and that it does, indeed, exist.

Manufacturers of products — hardware, software and firmware — are encouraged by us to submit their products to *the Rainbow* for certification. We ascertain that their products are, in actuality, what they purport to be and, upon such determination, award a Seal. This lets you know that we have seen the product and that it does, indeed, exist.

The Seal, however, is not a “guarantee of satisfaction.” The certification process is different from the review process. You are encouraged to read our reviews to determine whether the product is right for your needs.

There is absolutely no relationship between advertising in *the Rainbow* and the certification process. Certification is open and available to any product pertaining to CoCo. A Seal will be awarded to any commercial product, regardless of whether the firm advertises or not.

We will appreciate knowing of instances of violation of Seal use.

## Using Machine Language

Machine Language programs are one of the features of *the Rainbow*. There are a number of ways to “get” these programs into memory so that you can operate them.

The easiest way is by using an Editor-Assembler, a program you can purchase from a number of sources.

An editor-assembler allows you to enter mnemonics into your CoCo and then have the editor-assembler assemble them into specific instructions that are understood by the 6809 chip that controls your computer.

When you use an editor-assembler, all you have to do, essentially, is copy the relevant instructions from *the Rainbow's* listing into CoCo.

Another method of getting an assembly language listing into CoCo is called “hand assembly.” As the name implies, you do the assembly by hand. This can *sometimes* cause problems when you have to set up an ORIGIN statement or an EQUATE. In short, you have to know something about assembly to hand assemble some programs.

Use the following program if you wish to hand assemble machine language listings:

```
10 CLEAR200,&H3F00:I=&H3F80
20 PRINT "ADDRESS:";HEX$(I);
30 INPUT "BYTE";B$
40 POKE I,VAL("&H"+B$)
50 I=I+1:GOTO 20
```

This program assumes you have a 16K CoCo. If you have 32K, change the &H3F00 in Line 10 to &H7F00.

## What's A CoCo

CoCo is an affectionate name which was first given to the TRS-80 Color Computer by its many fans, users and owners. As such, it is almost a generic term for three computers, all of which are very much alike.

When we use the term CoCo, we refer to the TRS-80 Color Computer, the TDP System-100 Computer and the Dragon-32 Computer. It is easier than using the three “given” names throughout *the Rainbow*.

In most cases, when a specific computer is mentioned, the application is for that specific computer. However, since the TDP System-100 and TRS-80 Color are, for all purposes, the same computer in a different case, these terms are almost always interchangeable.

## The Rainbow Check

The small boxes which you see with programs in *the Rainbow* are our *RAINBOW CHECK* program, which is designed to help you type in programs accurately.

The check program will count the number of characters you type in. You can then compare the number the *RAINBOW CHECK* gives you to those printed in *the Rainbow*. On longer programs, some benchmark lines are given. When you reach the end of one of those lines with your typing, simply check to see if the numbers match.

To use the *RAINBOW CHECK*, type in the program, *CSAVE* it for future use, then type in the command *RUN* and press *ENTER*. Once the program has run, type *NEW* to remove it from that area into which you will be keying programs.

Now, whenever you press the down arrow, CoCo will give you the hexadecimal number of bytes in memory. This is to check against the numbers printed in *the Rainbow*. If your number is different, check the listing carefully to be sure you typed in the proper BASIC program code.

As the hexadecimal number appears in the upper-left corner of the monitor screen, you may want to clear the screen and press the spacebar five or six times to move the cursor out of the way for easy reading. The *RAINBOW CHECK* counts spaces, too, follow the spacing just as it appears in the magazine.

Here's the program:

```
10 CLS:IF PEEK(116)=127 THEN
X=32688 ELSE X=16304
20 CLEAR 25,X-1
30 IF PEEK(116)=127 THEN X=32688
ELSE X=16304
40 FOR Z=X TO X+77
50 READ Y:W=W+Y:PRINT Z,Y;W
60 POKE Z,Y:NEXT
70 IF W=5718 THEN 80 ELSE PRINT
"DATA ERROR":STOP
80 EXEC X:END
90 DATA 182, 1, 106, 167, 141, 0, 68
100 DATA 134, 126, 183, 1, 106, 190
110 DATA 1, 107, 175, 141, 0, 57, 48
120 DATA 141, 0, 4, 191, 1, 107, 57
130 DATA 129, 10, 38, 44, 52, 22, 220
140 DATA 27, 147, 25, 142, 4, 0, 141
150 DATA 6, 31, 152, 141, 2, 32, 25
160 DATA 52, 2, 68, 68, 68, 68
170 DATA 141, 4, 53, 2, 132
180 DATA 15, 129, 9, 46, 4, 139, 112
190 DATA 32, 2, 139, 55, 167, 128, 57
200 DATA 53,22,126,0,0
```

# HARDWARE & PROGRAMS

We carry products  
from many manufacturers.  
If you don't see it, ask.

**JARB** SOFTWARE  
HARDWARE  
BB (19) 474-8981 VOIC (19) 474-912

1636 D Avenue, Suite C  
National City, CA 92060

NEW



## SATURN SOFTWARE SPLC-1

Lower Case For The  
COLOR COMPUTER and TDP-100

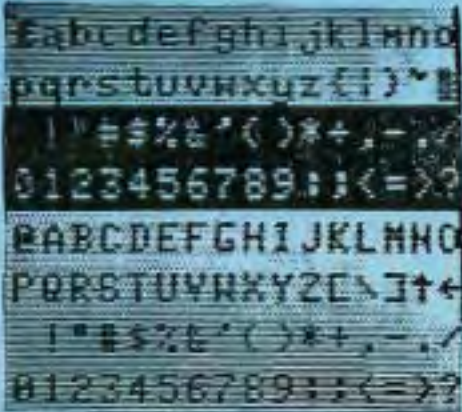

- True lower case characters.
- Fully assembled, tested and guaranteed for 90 days
- No cutting or soldering
- The SPLC-1 is fully compatible with all TRS-80C
- Inverted video at a flip of a switch
- Installation will void the Radio Shack warranty.



**\$59.95**



### L CINT

Lower case interpreter program allows input of lower case command words to be accepted. Also allows for one key pause features and single step through listings. With instructions and cassette, disk compatible, .....\$10.95

U.S FUNDS ONLY  
C.O.D. ORDERS ACCEPTED  
Sorry, no C.O.D. on printers and monitors.  
NO CREDIT CARD ORDERS

## MONITORS

### BMC MEDIUM-RES

- 12" Green Screen ..... \$ 89.95
- 13" color w/ sound ..... \$303.95

### COMREX HI-RES

- 12" Green Screen ..... 164.95
- 12" Yellow Screen ..... 169.95
- 12" Amber Screen ..... 174.95

### VIDEO PLUS

(by Computerware)

This unit will allow you to bring the composite video signal out of the computer to any monitor, color or monochrome. Sound output is also provided. No soldering or holes to cut. Easy installation instructions are provided.....\$24.95

## MEMORY UPGRADE KITS

### 16K RAM CHIPS ..... 1.50 ea.

#### \*16K/32K

Eight 200 NS Factory Prime Chips with Piggy Backed Sockets, Sam Socket, Bus Wire. Comprehensive Instructions. Recommended for "D" or earlier, but may be used on "E". Only 9 simple solder connections to kit. None to computer. \$25.95

#### \*64K RAM CHIPS

Eight 200 NS Factory Prime 64K RAM Chips. Allows you to upgrade "E" board easily. No soldering needed. .... \$69.95

NOTE: 64K upgrade will NOT provide 64K of user Ram, but allows later revision boards (E, ET) to run cooler and more efficiently.

\*Installation of these items will void the Radio Shack warranty. Radio Shack is a trademark of the Tandy Corp.

## DATABASE / MAILER LETTER WRITER

by EVS

Tape version doesn't require EXT. Basic.  
CC-DBM/CC-LW .....\$49.95

All programs warrantied 60 days from date of purchase to original purchaser.

## REDWOOD GOLF

by David C. Langford

© JARB software 1985

A truly realistic and interesting golf simulation in hi-res graphics. Each game is different as the fairways are randomly generated. Up to four players can play at a time, and one joystick is required. REDWOOD GOLF is an easy to learn, yet challenging simulation for all ages. On cassette for 32K EXT .....\$24.95

## JARB DISK DOUBLER

Why spend twice as much as you need to for double sided diskettes? With our doubler, you can make your own and pay for it with the first box you double. A must for disk drive users.  
5 1/4" size only ..... 12.95

## BASF DATA CASSETTES

	C-05	C-10
1-10	.60 ea.	.65 ea.
11-20	.55 ea.	.60 ea.

- Soft Poly Cases ..... Ea. \$.20
- Hard Shelled Cases ..... Ea. \$.22
- Cassette Labels (12) ..... Sh. \$.36
- Cassette Labels Tractor (1000) .... \$ 21.95

## FOR SERIOUS APPLICATIONS:

- Teletwriter-64 (Cognitec) 49.95 Cass. 59.95 Disk
- Coco-Writer (Moreton Bay) ..... 34.95
- File Cabinet (Moreton Bay) ..... 29.95
- Report (Moreton Bay) ..... 24.95
- Color Diagnostic (Computerware) ..... 17.95
- Programmers Toolkit (Moreton Bay) .... 28.95

## PRINTERS AND ACCESSORIES

- EPSON RX-80 ..... \$449.00
- EPSON RX-80-FT ..... \$525.00
- EPSON FX-80 ..... \$575.00
- COMREX COMRITER CR-1C. \$722.00
- BOTEK PARALLEL INTERFACE ..... \$ 69.95

## COCO

### PRINTER PACKAGES

- includes printer & Botek interface
- EPSON FX-80 ..... \$635.00
- COMREX CR-1C ..... \$783.00

# An Introduction To The Science Of Image Processing

By Robert K. Tyson, Ph.D.

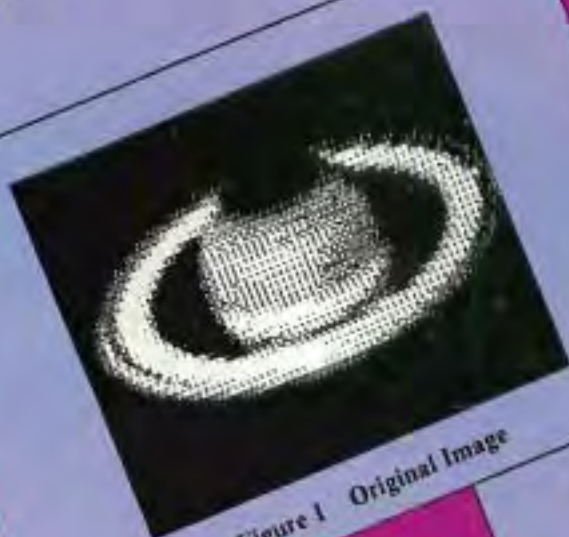

Figure 1 Original Image



Figure 2 Same Image



Figure 4



Figure 3

(Dr. Bob Tyson is a senior systems engineer at United Technologies Research Center, where he designs and analyzes high energy laser systems using computer simulations. He is the author of "Strategy Football" and "Election '84," which recently appeared in the Rainbow.)



Figure 5 Resulted Image

**M**icrocomputers are good for a lot of things that used to be done by hand, like filing, counting, simple arithmetic, typing complicated mathematics, or game playing. Only when computers began doing things that couldn't be done any other way, were we in the computer age. The first video game, Pong, was evolutionary. It had its alter ego on the tennis court because it could be "played" there. But the computer game, *Breakout* was revolutionary. It had no such alter ego in the real world. It only made sense as a video game and was a true "computer" game. Scientific programming had the same evolution. Early computers could calculate the roots of a quadratic equation very fast but there already was a simple equation for it, so computers weren't needed. Image processing needed a computer. Stereo viewers and overlaying transparencies were crude tools for image enhancement. The computer and its lightning-fast speed revolutionized image processing to create what it is today.

Image processing is seen all around us in magazine advertisements, police fingerprint identification, the weather report, medicine, and the entertainment industry (especially television). The most dramatic examples have been the phenomenal satellite pictures from Jupiter and Saturn. The original "images" were just streams of zeroes and ones with noise. These are smoothed, enhanced, averaged, and modified into the pictures that we see. Without digital image processing, this science, and what it produces, would not be possible.

What is image processing? It is the procedure where a two-dimensional image is changed to make it more easily perceived, by either the human eye or an electronic eye. The useful information is contained in a raw image, but it is often obscured by blurring, camera or object motion, electronic noise, or background light. Image processing can be applied to remove the obscuring effects and retrieve the information.

What does the program do? Lines 500-510 contain the menu and "traffic cop." Everything branches from here. Lines 9000-9026 contain a coded "image" of the planet Saturn to use as an example. The image is coded as strings of hexadecimal values with G=16 rather than 10. The rest of the program works in an "operator" fashion. That is, a section is branched to, something happens, and it returns to line 500. What happens? Now the fun part comes in.

Listing 1 is a BASIC program that demonstrates the important techniques and allows you to enhance any image. The program also shows the versatility of the TRS-80 Color Computer for serious scientific work. It requires a 32K Extended BASIC CoCo (with disk and printer optional, but recommended). The program proceeds by allowing you, the user, to "operate" on a Raw Image and then display the Processed Image. You can use this process to "operate" again and again, and produce more processed images. You should remember that the processing is usually irreversible (called Destructive) and "inverse" operations are rare. In other words, once you smooth a raw image you cannot get the raw image back unless you stored it somewhere. This makes a disk drive useful and almost necessary. You can store and retrieve images quickly. For those without a disk, I will describe the modifications you need for cassette tape storage.

The program is menu-oriented. After keying-in the program, type *RUN*. Remember to leave spaces as you type since the compressed format will only work after it is tokenized. The logo will be displayed while it loads a machine language program from DATA lines 9100-9106. A menu will appear with eight choices. Three of the options will not

alter the image (D,V,P); five of them will change it. I will briefly describe how the program works and then tell you how you can use it.

Memory area \$4A00-\$4C0B contains a machine language program shown in listing 2. This accomplished all the tough tasks fast. I originally wrote the whole program in BASIC but it was just too slow. It took three minutes just to display the image with *GET* and *PUT*. Memory area 23072-26143 contain the image. It is a 64-column by 48 row matrix with 64 gray levels. It contains  $64 \times 48 = 3072$  bytes. Memory area 20000-23071 contains a scratch pad area. Whenever a complicated operation is performed, the computer must "read" the image and store a result without altering the original image. Only when the process is complete does it transfer the scratch pad over to the image matrix for you to see. The memory area above 26144 is available for a printer driver routine for graphics hard copy. My program loads the routine from line 2264. Your routine should load it there too. Just change DEFUSR7 in line 23 to whatever address your printer driver needs. Also set the *POKE150* in line 2264 to the Baud rate of your printer/interface. If you use a 600 Baud printer (like DMP 100, DMP 200, LP VII, etc.) don't *POKE* anything.

Lines 1000-1330 create an image from a menu. Four images can be formed. The first is a test pattern which has all the gray scales (density of dots) and the letter "H." The second is an image of the planet Saturn (only the non-zero lines are stored in data; the zeroes are entered by clearing the image with a *USR1* call in line 1200). The third possibility is loading a previously stored image. The program is set up for disk storage, but a simple *CLOADM K\$* in line 1320 will allow tape storage. Also change line 8020 to read *CSAVEM*, etc. if you are going to use cassette tape. The fourth "image" is choice 0 — just clear the image.

Lines 2000-2264 display the image on the screen in 64 x 48 picture elements (pixels) with from 0 to 16 dots in a pixel. This means it is actually 17 gray levels but no image processing scientist would admit to having an odd number of gray levels. The display routine is in machine language located at \$4AF2. It steps through the rows and columns using the value of the pixel to offset a lookup to the table of dot-pattern values stored at \$4BC7. It then moves the dots to the most-significant nibble (4 bits) or the least significant nibble of the 8-bit "word." It stores this value on graphics Page 1. If you press [H] while the display is on, the program jumps to your printer driver routine to produce a hard copy for you. Any other key-press will just return you to the menu.

Line 3000 performs an "edge enhancement." This is a Destructive operation which will highlight all the high contrast edges in your image. Low contrast areas like smooth surfaces will just be zeroed. Sharp edges are enhanced. The ML routine at \$4A98 performs this operation. It steps through the rows and columns and subtracts neighboring values to the right and below it. It then takes the absolute value of this sum and stores it in the scratch pad. After all the pixels (except the border which doesn't have meaningful neighbors) are operated upon, the routine transfers the scratch pad into the new image.

Lines 4000-4040 add noise to the image. This is done in BASIC with the *RND* function. Adding noise is not image processing, but it is necessary to show you what a processor can do with a messy image. This routine is here just to "mess up" your image so the real image processing can be demonstrated. It is, by definition, Destructive. You are prompted for the number of pixels you want noisy. A "little" noise may be 100 pixels and a "lot" of noise is all 3072 pixels. The value

of the noise is the seed of RND for adding it to each pixel. Any number will do to simulate real image noise but I like 5 just to make it look neat.

Lines 5000—5600 display the image in pseudo-colors. This is a Non-Destructive process which just displays the image on a *PMODE 1* screen in four colors. Low valued pixels are green, next are yellow, etc. This is called pseudo-color, since it is often used to outline certain regions in an image when the image itself (like a medical X-ray) has no color information. After all, Saturn is really not green, blue, red, and yellow in the way that you will see it here. This routine is slow since it is written in BASIC. I didn't write it in assembler since I use it very little. The four gray levels (four colors) are good for CoCo demonstrations, but not for serious work.

Lines 6000—6010 perform a nine-point smoothing operation. This is a Destructive routine in ML at \$4A30. This routine steps through the rows and columns and takes the average value of the pixel and its eight surrounding neighbors. It puts it in the scratch pad and then, when it completes all the pixels, it transfers the scratch pad to the image.

Lines 7000—7570 allow a histogram modification. The histogram is essentially a table of conversion values for the display. Normally when the value of a pixel is 5 it will display five dots in that pixel area, or 11 dots for a value of 11, etc. however, by modifying the histogram, we can make the *image* scale change. As an example, if you have a constant low light level background in an image with a value of three, the image tends to "wash out" . . . like watching a movie with the house lights on. If we subtract three from each pixel, the final image would have the "washout" removed. The routine in BASIC and ML at \$4B97 allows you to threshold, add or subtract a constant value, or make a custom histogram. The custom histogram is most useful for eliminating weird camera effects or blurring. In all cases, the new histogram, ie, the conversion, will be displayed before you commit, since this is a Destructive process. You can't be too careful.

Lines 8000—8030 save the image in memory 23072—26144 to disk. Tape cassette modifications are described above.

Since you're now probably tired of reading all of this, let's go through an example to see just what this image processing is all about. Load the program and type *RUN*. The ML program will take a few seconds to load. At the menu hit [C] to create an image. At the "create" menu, hit [2][ENTER] to produce the image of Saturn. It will take about a minute to read the data. The main menu will appear. Now hit [D] to display it. Wow! The image should look like figure 1. If you want a hard copy (ie, your printer is on, and you changed lines 23 and 2264) then hit [H] otherwise, hit any key and the main menu will reappear. You can always redisplay it any time.

Now, let's see what the program can really do. Hit [N] for noise. At the prompt for the number of pixels, type 1200 [ENTER]. At the prompt for the strength, type 5 [ENTER]. Watch the counter as it fills in random pixels. Now from the main menu, hit [D] and look at that mess! Your image should look like the noisy image in figure 2. The multiple reproductions necessary to print images in magazines have a "smoothing" effect so your image should appear noisier than that shown. This problem consistently causes magazine and newspaper publishers fits. But here's what can be done about it. Go to the main menu with your noisy image of Saturn. Hit [H] for histogram modification. Now hit [A] for add and type -5 [ENTER]. This will subtract five from each

pixel. Now [D], display the image; it should look like figure 3. Not bad, but let's go further. From the main menu hit [S] to smooth the image. Now display it. Figure 4? That's a good image, but we can do better. There were too few bright areas. In other words, the contrast was low. From the main menu hit [H] to modify the histogram again. Let's just multiply each value by two to double the contrast. How? Use the custom histogram; hit [C]. Now just type in the following custom histogram:

```
0 -> 0, 1 -> 2, 2 -> 4, 3 -> 6, 4 -> 8, 5 -> 10, 6 -> 12,
7 -> 14, 8 -> 16, and all the rest -> 16.
```

When it asks "Sure?" check your input and type [Y]. Now look at your restored image of Saturn, figure 5. Not exactly like Figure 1, but that is not mathematically possible after you inserted random noise. It's still a pretty good attempt at it.

The rest is up to you. Try the test pattern and hit [E] to edge enhance it. Or smooth it. Or use the data lines to enter your own image. As demonstrated, the possibilities are endless.

This article gives you an introduction to the science of image processing. By no means is it complete. There are many other methods employed. Something called "filtering" is a very powerful tool. Smoothing and edge enhancement are special types of filtering and there are volumes written on the particular topic. If you're interested, keep at it. Try your own combinations and see what you can do. The computer age is here for all of us.

#### Rainbow Check Plus

1000	0313	150
1330	052C	164
5000	075C	60
7030	0A64	237
8000	0C61	227
9010	0F9B	240
9020	1261	157
9102	16EA	1
9104	18D4	22
END	1B06	149

#### The listing:

```
5 GOTO10000
7 FLAG=0:GOSUB9900:FORI=0TO26:RE
ADK$:NEXT
8 FORI=&H4A00TO&H4C0B:READK$:POK
EI,VAL("&H"+K$):NEXT
15 VD=23072:VV=&H4BAC
17 DEFUSR1=&H4A00:'CLEAR VID
18 DEFUSR2=&H4B97:'HISTOG. MOD
20 DEFUSR4=&H4A30:'SMOOTH
21 DEFUSR5=&H4A98:'EDGE
22 DEFUSR6=&H4AF2:'DISPLAY
23 DEFUSR7=&H7D92:'HARD COPY
500 CLS:PRINT@140,"M E N U":PRIN
T:PRINT" c CREATE IMAGE":PRINT"
d DISPLAY IMAGE":PRINT" n ADD NO
ISE":PRINT" s SMOOTH IMAGE":PRIN
T" h HISTOGRAM MOD":PRINT" v SAV
E TO DISK":PRINT" e EDGE ENHANC
EMENT":PRINT" p PSEUDO-COLOR ENH
ANCEMENT"
505 PRINT@480,"DURING DISPLAY, P
RESS <H> FOR HARD COPY"
510 K$=INKEY$:IFK$=""THEN510ELSE
```

```

IFK$="C" THEN 1000 ELSE IFK$="D" THEN
2000 ELSE IFK$="E" THEN 3000 ELSE IFK$
="N" THEN 4000 ELSE IFK$="P" THEN 5000
ELSE IFK$="S" THEN 6000 ELSE IFK$="H"
THEN 7000 ELSE IFK$="V" THEN 8000
1000 CLS:PRINT"CREATE IMAGE":PRI
NT@128,"O=ERASE IMAGE
      1=TEST PATTERN
      2=SATURN
      3=FROM DISK"
1010 INPUTK:ONK+1GOTO1011,1020,1
200,1300,1010
1011 X=USR1(0):GOTO500
1015 PRINT"WORKING ...":RETURN
1020 GOSUB1015:X=USR1(0):'TEST P
ATTERN
1030 FORIR=8TO40:FORIC=20TO26:PO
KEVD+IR*64+IC,8:NEXTIC:FORIC=38T
O44:POKEVD+IR*64+IC,8:NEXTIC,IR
1050 FORIR=20TO28:FORIC=27TO37:P
OKEVD+IR*64+IC,8:NEXTIC,IR
1060 FORI=0TO16:POKEVD+I,I:POKEV
D+I+64,I:POKEVD+I+128,I:POKEVD+I
+192,I:NEXT
1070 GOTO500
1200 GOSUB1015:X=USR1(0):'SATURN
1205 RESTORE:FORJ=0TO26:READK$:F
ORI=1TO64:IFMID$(K$,I,1)="G" THEN
1248 ELSE V=VAL("&H"+MID$(K$,I,1))
1232 GOTO1250
1248 V=16
1250 POKEVD+639+64*J+I,V
1260 NEXTI,J
1280 GOTO500
1300 CLS:PRINT"LOAD FROM DISK":P
RINT"ENTER DISK FILENAME/EXT"
1310 INPUTK$
1320 LOADMK$
1330 GOTO500
2000 PMODE4,1:SCREEN1,1:PCLS
2010 X=USR6(0)
2250 K$=INKEY$:IFK$="" THEN 2250EL
SE IFK$="H" THEN 2262 ELSE 2260
2260 SCREEN0,0:GOTO500
2262 SCREEN0,0:IFFLAG=0 THEN 2264E
LSE 2263
2263 X=USR7(0):GOTO500
2264 FLAG=1:POKE150,1:LOADM"GSFR
P.BIN":GOTO2263
3000 CLS:PRINT"EDGE ENHANCEMENT"
:X=USR5(0):GOTO500
4000 CLS:PRINT"ADD NOISE":PRINT"
ENTER NUMBER OF PIXELS AFFECTED
      1 - 3072"
4010 INPUTK:IFK<0ORK>3072 THEN 400
0
4012 PRINT"ENTER STRENGTH OF NOI
SE
      0 - 16"
4014 INPUTI:IFI<0ORI>16 THEN 4012
4020 PRINT@294,K$:FORJ=0TOINT(K)

```

```

:PRINT@300,J:R=RND(3072):A=VD+R:
V=PEEK(A):V=V+RND(I):IFV>16 THEN V
=16
4035 POKEA,V:NEXTJ
4040 GOTO500
5000 PMODE1,1:SCREEN1,0:PCLS:FOR
IR=0TO47:FORIC=0TO63:V=INT((PEEK
(VD+IR*64+IC)+3)/4):IFV=0 THEN V=1
5010 FORIR=0TO47:FORIC=0TO63
5015 V=INT((PEEK(VD+IR*64+IC)+3)
/4):IFV=0 THEN V=1
5020 PSET(IC*4,IR*4,V):PSET(IC*4
+2,IR*4,V):PSET(IC*4,IR*4+2,V):P
SET(IC*4+2,IR*4+2,V):NEXTIC,IR
5500 K$=INKEY$:IFK$="" THEN 5500EL
SE 5600
5600 PMODE4,1:GOTO500
6000 CLS:PRINT"9 - POINT SMOOTHI
NG"
6010 X=USR4(0):GOTO500
7000 CLS:PRINT"HISTOGRAM MODIFIC
ATION
      SELECT MODE:
      t=THRESHOLD
      a=ADD CONSTANT
      c=CUSTOM HISTOGRAM"

```

```

M"
7005 K$=INKEY$:IFK$="" THEN 7005EL
SE IFK$="T" THEN 7007 ELSE IFK$="A" TH
EN 7100 ELSE IFK$="C" THEN 7300 ELSE 70
05

```



**At Last!**

## YOU CAN SORT LARGE FILES

— PRESENTING —

# VSDSORT

VSDSORT IS AN EASY TO USE DISK SORT UTILITY THAT WILL ALLOW YOU TO SEQUENCE LARGE DISK FILES AS YOU WISH.

- UP TO FIVE KEYS
- FULL RECORD OR TAG OUTPUT
- MANUAL OR PROGRAM CALLABLE/RETURNABLE
- SINGLE OR MULTI DISK

**EXT. DISK BASIC REQUIRED**

SEND CHECK OR MONEY ORDER FOR \$49.95 + 3.00 SHIP/HANDLING TO:



DEPT. 125  
VAL SYSTEMS  
15 E. MOUNTAIN AVENUE  
PEN ARGYL, PA 18072  
(215) 863-9167

NAME \_\_\_\_\_  
ADDRESS \_\_\_\_\_  
CITY \_\_\_\_\_ STATE \_\_\_\_\_ ZIP \_\_\_\_\_  
PA. RESIDENTS ADD 6% SALES TAX

```

7007 PRINT"ENTER THRESHOLD MINIM
UM 0 TO 15":INPUTTM:TM=INT(TM):I
FTM<OORTM>15THEN7007
7010 PRINT"ENTER THRESHOLD MAXIM
UM ";TM+1;" TO 16":INPUTT
X:TX=INT(TX):IFTX<TMORTX>16THEN7
010
7020 IC=1:GOTO7400
7100 PRINT"ADD CONSTANT TO ALL V
ALUES"
7110 PRINT"ENTER CONSTANT -15 TO
15":INPUTK:IFK<-15ORK>15THEN711
0
7120 IC=2:GOTO7400
7300 CLS:PRINT"CUSTOM HISTOGRAM
MODIFICATION":IC=3
7400 FORI=0TO16:ONICGOSUB7450,74
60,7470
7410 NEXTI:GOSUB7500:IFJ=0THEN50
0
7420 X=USR2(0):GOTO500
7450 IFI<TMTHENPOKEVV+I,TMELSEIF
I>TXTHENPOKEVV+I,TXELSEPOKEVV+I,
I
7451 RETURN
7460 V=I+INT(K):IFV<0THENPOKEVV+
I,0ELSEIFV>16THENPOKEVV+I,16ELSE
POKEVV+I,V
7461 RETURN
7470 PRINT"CONVERT FROM ";I;" TO
";:INPUTJ:IFJ<0DRJ>16THEN7470EL
SEPOKEVV+I,INT(J)
7471 RETURN
7500 CLS:PRINT"HISTOGRAM MODIFIC
ATION"
7510 FORI=0TO15STEP2
7520 PRINTI;"->";PEEK(VV+I);"
";I+1;"->";PEEK(VV+I+1)
7530 NEXTI
7540 I=16:PRINTI;"->";PEEK(VV+I)
7550 PRINT:PRINT:PRINT"SURE ? (
Y/N)"
7560 J=0:K$=INKEY$:IFK$=""THEN75
60ELSEIFK$="Y"THENJ=1ELSEIFK$<>"
Y"THENJ=0
7570 RETURN

```

```

8000 CLS:PRINT"SAVE TO DISK":PRI
NT"ENTER DISK FILENAME/EXT"
8010 INPUTK$
8020 SAVEMK$,23072,26144,23072
8030 GOTO500
9000 DATA 0000000000000000000000
01122211000000000001221000000000
0000000000
9001 DATA 00000000000000000000123
235860000000000000000562112210000
0000000000
9002 DATA 00000000000000000123358D
GGGD500000000000000008FGEC710110
0000000000
9003 DATA 00000000000002334BGGGG
GGC63000000000000001004DEEEEE900
2200000000
9004 DATA 000000000003437EGGGGGD
CAA7431000000000002231006BDDEEDC
4022000000
9005 DATA 0000000002426EGGGGD710
4AB9975332111112234564000006BCDE
EC20210000
9006 DATA 00000001443DGGGGGB40000
9BBBBA99877556566676540000005BC
DD8012000
9007 DATA 0000001546GGGGD6000005
CCBCBCBBA99989997678200000008
CDDDB00300
9008 DATA 000002746GGGGC30000009
CCCCCCCCDDCCCCA999998500000000
6BDAC90230
9009 DATA 00002665GGGGFC30000002A
DDDEDCCDDBBCBBAABBA98400000000
07CDDC5040
9010 DATA 0000592DGGGGE700000005B
CCDDDEEEEEEDDDCCCCBA977400000000
02ADDCC23
9011 DATA 0002976GGGGC100000007B
CCDEEEEEEFEEEDCCBAA976510000000
009DDDD104
9012 DATA 0005B5AGGGGA100000007B
CCBCDDEDDDDDDCDCBAA9885410000000
008DDDD204
9013 DATA 0016D4CGGGFA100000005A
CCCCCDDDDDDCCCCB998764200000000
009DDDC123
9014 DATA 0018D6AGGGGC100000007B
ABCCCCDDDDDDCCA99998665310000000
03BDDDA041
9015 DATA 0006CA5GGGGGE600000006D
DCBCCCDCCCCDDCCBAA98678830000000
09DCDC3030
9016 DATA 0003BE6DGGGGD20000003D
BFEDDDDDCCDCBBA998ABC800000000
8CDCC80510
9017 DATA 00007DD6GGGGGD2000001B
FGFGGGFEEEEEECCCCCCEDC940000009
DDCD904200
9018 DATA 000029EC8GGGGGE5000005

```



**FLORIDA SEARCH NO LONGER!**

The Software Connection of Fort Lauderdale is your one stop source for your Color Computer Software, Peripherals, Books, Magazines & Repairs

**THE SOFTWARE CONNECTION, INC.**

5460 No. State Rd. 7, Suite 108  
Fort Lauderdale, FLORIDA 33319  
(305) 484-7547



```

CEFGGGGGGGGGEFFFEFFEDC950000003BD
DDD8042000
9019 DATA 0000019FE8FGGGGGGC30000
5ACDEGFFGFFFGFEEEDCA75100002ADDD
DC50410000
9020 DATA 00000017EFBCGGGGGGGE700
3868ABCDDEEDDCB9864453006CDDDDC
9333000000
9021 DATA 000000003BFEBDGGGGGGGGE
EEDCCBAAA99998889ABDDDCDEDDDD95
5400000000
9022 DATA 00000000003BEEDDGGGGGGG
GGGGGGGFEEEDDEEEEEEEEEEEECDB9676
1000000000
9023 DATA 00000000000017CEEDDFGG
GGGGGGGGGGGFFFEEDDEEDCA998400
0000000000
9024 DATA 00000000000000026BDEED
EEFGGGGGGGGGGFEEEDDCBAB98400000
0000000000
9025 DATA 0000000000000000000158
BCEEDDEFGGFFFFEDCCBA964100000000
0000000000
9026 DATA 0000000000000000000000
00001346777776431000000000000000
0000000000
9100 DATABE,5A,20,4F,A7,84,30,01
,8C,66,21,25,F7,39,8E,4E,20,A6,8
4,A7,89,0C,00,30,01,8C,5A,21,25,
F3,39,8E,4E,20,A6,89,0C,00,A7,84
,30,01,8C,5A,21,25,F3,39,8D,ED,8
6,01,B7,4B,BE,B7,4B,BD,B6,4B,BE,
C6,40,3D,FD,4B,C1,4F,F6,4B,BD,F3
,4B,C1,C3,5A,20,1F,01,A6
9101 DATAB4,AB,1F,AB,01,AB,88,C1
,AB,88,C0,AB,88,BF,AB,88,3F,AB,8
8,40,AB,88,41,5F,80,09,2D,03,5C,
20,F9,C1,10,23,02,C6,10,E7,89,F4
,00,B6,4B,BD,4C,B7,4B,BD,81,3F,2
5,B6,86,01,B7,4B,BD,B6,4B,BE,4C,
B7,4B,BE,81,2F,25,A6,17,FF,77,39
,17,FF,84,7F,4B,BD,7F,4B
9102 DATABE,B6,4B,BE,C6,40,3D,FD
,4B,C1,4F,F6,4B,BD,F3,4B,C1,C3,5
A,20,1F,01,A6,84,A0,01,2C,02,43,
4C,B7,4B,BF,A6,84,A0,88,40,2C,02
,43,4C,BB,4B,BF,84,0F,A7,89,F4,0
0,B6,4B,BD,4C,B7,4B,BD,81,3F,25,
C3,86,01,B7,4B,BD,B6,4B,BE,4C,B7
,4B,BE,81,2F,25,B3,17,FF
9103 DATA1D,39,DC,BA,FD,4B,C5,7F
,4B,BE,7F,4B,BD,B6,4B,BE,C6,40,3
D,FD,4B,C1,4F,F6,4B,BD,F3,4B,C1,
C3,5A,20,1F,01,B6,4B,BE,C6,80,3D
,FD,4B,C1,F6,4B,BD,4F,54,F3,4B,C
1,F3,4B,C5,1F,02,86,00,B7,4B,C0,
B7,4B,C1,8D,3F,86,11,B7,4B,C0,86
,20,B7,4B,C1,8D,33,86,22
9104 DATAB7,4B,C0,86,40,B7,4B,C1
,8D,27,86,33,B7,4B,C0,86,60,B7,4

```

```

B,C1,8D,1B,B6,4B,BD,4C,4C,B7,4B,
BD,81,3F,25,9B,7F,4B,BD,B6,4B,BE
,4C,B7,4B,BE,81,30,25,8D,39,34,2
0,A6,84,BB,4B,C0,31,8D,00,4B,E6,
A6,58,58,58,58,F7,4B,BF,A6,01,BB
,4B,C0,E6,A6,FB,4B,BF,B6
9105 DATA4B,C1,35,20,E7,A6,39,8E
,5A,20,31,8D,00,0E,A6,84,E6,A6,E
7,84,30,01,8C,66,20,25,F3,39,08,
F7,00,FF,00,F7,28,B7,00,FF,00,F7
,00,F7,00,F7,00,F7,00,FF,00,D7,0
0,FF,00,D7,00,00,00,02,04,04,02,
02,0A,0A,0B,0B,0E,0E,0E,0E,0F,0F
,00,02,00,01,01,05,05,05
9106 DATA05,05,05,05,07,07,07,07
,0F,00,00,04,04,08,02,0A,0A,0A,0
A,0E,0B,0E,0F,0F,0F,0F,00,00,00,
00,02,08,04,04,05,05,05,0D,07,07
,0F,0F,0F,00
9900 CLS3:PRINT@170,"
";:PRINT@202," I M A G E ";:PRIN
T@224,STRING$(32,143);:PRINT" P
R O C E S S I N G ":PR
INTSTRING$(32,143);:PRINT@326,"
BY DR. BOB TYSON ";:PRINT@364,"
1983 ";:RETURN
10000 CLEAR200,18943:GOTO7

```

## COLOR-FORTH

Including SEMIGRAPHIC-8 EDITOR  
+ UTILITIES

- Disk and Tape utilities
- Boot from disk or tape
- Graphics and Sound commands
- Printer commands
- Auto-repeat and Control keys
- Fast task multiplexing
- Unique TRACE function in kernal
- Clean INTERRUPT handling  
in HIGH-LEVEL FORTH
- CPU CARRY FLAG accessible
- Game of LIFE demo
- ULTRA FAST:written in assembler
- Directions included for  
installing optional ROM in  
disk controller or cartridge
- Free Basic game "RATMAZE"

\$58.95

# FORTH

HOYT STEARNS ELECTRONICS  
4131 E. CANNON DR. PHOENIX, ARIZONA 85028  
602-996-1717

# RAINBOW

**Give us your best:** Join the ranks of these courageous CoCoists in showing the Color Computer world your high score at your favorite micro-diversion. We want to put your best effort on record in the Rainbow's Scoreboard column. All entries must be received by the first of the month to be eligible for the following month's Scoreboard. They must include your *full* name, address, game title, company name and, of course, your high score. Each individual is limited to three score entries per month. Send your entries to Scoreboard, c/o the Rainbow.

★ **New Number One**

● **Last Month's Number One**

<b>ALCATRAZ II</b> (Spectral Associates) 18,790 ★Chris Sweet, Harvard, MA 8,710 Kanti Dinda, Kingston, Ontario	<b>CAVE HUNTER</b> (Mark Data) 42,600 ★Gary Ritchie, Bellevue, Alberta 40,600 Lori Raskob, Esalon, CA 27,050 Jim Baker, Florissant, MO 26,300 Mike Hughey, King George, VA	<b>DEATH TRAP</b> (Soft Sector) 124,145 ★Donut, Tabor, IA 89,035 ●Keith Philabaum, Coschocton, OH 84,672 Jeff Willard, Chilceno, TX 78,234 Richard Grondin, Flint, MI 67,920 Bart, Tabor, IA 61,298 Monte North, Tabor, IA
<b>ANDROID ATTACK</b> (Spectral Associates) 25,000 ★Wes Hill, Vashon, WA 15,500 Cameron Amick, Reisterstown, MD	<b>CHOPPER STRIKE</b> (MichTron) 63,000 ★Andrew Figel, Sardis, OH 47,400 David Figel, Sardis, OH 29,900 Bobby Figel, Sardis, OH	<b>DEFENSE</b> (Spectral Associates) 99,485 ★Mitchell Dombrowski, Detroit, MI 68,750 M. A. Brickler, Allen Park, MI 58,900 Greg Scott, Orlando, FL
<b>ASSAULT</b> (MichTron) 2,322 ★Kevin Mesecher, Ft. Walton Beach, FL	<b>CLOWNS &amp; BALLOONS</b> (Radio Shack) 85,680 ★Teresa Stutsman, N. Little Rock, AR 83,710 Don Fraser, Shakope, MN 79,920 Tim Welchmann, Marblehead, MA 77,910 Dan James, Clearwater, FL 74,920 Sal Barlett, Mesa, AZ	<b>DEVIL ASSAULT</b> (Tom Mix) 69,300 ★Rick Arthur, Ballston Lake, NY
<b>ASTEROID</b> 1,100 ★Matt McMann, New Boston, MI	<b>COLOR CUBES</b> (Radio Shack) 4,50 ★John Handis 6,05 Chris Cope, Central, SC	<b>DOODLEBUG</b> (Computerware) 3,011,320 ★Brenda Gaetz, Gillane, Manitoba 2,248,840 Donut, Tabor, IA 2,191,110 Eugene Shinkewski, Prince Albert, Saskatchewan
<b>ASTRO BLAST</b> (Mark Data) 158,000 ★Larry Plaxton, Medley, Alberta 157,000 Scott Drake, Pine City, NY 104,464 Jim Baker, Florissant, MO 98,000 Tim Warr, Bellingham, WA 92,000 Harry Sawyer, Watchung, NJ	<b>COLOR HAYWIRE</b> (Mark Data) 22,050 ★Jim Baker, Florissant, MO 17,850 Brian Wallingford, Fall River, MA 14,850 Michael Rhaltigan, Cary, NC 14,800 Brad Widdup, Dundas, Ontario 14,750 Rich McGervey, Morgantown, WV	<b>DOUBLEBACK</b> (Radio Shack) 1,080,000 ★Phillipe Duplanties, St. Jerome, Quebec 605,890 Peter Sherburne, Highland, CA 474,040 Paul Moritz, Butte, MT 435,570 Phillippe Morsan, St. Jerome, Quebec 429,000 Steve Darm, Phoenix, AZ 72,354 Tony Pink, Gerard, OH 40,200 Chip Pink, Gerard, OH
<b>AVENGER</b> (The Cornsoft Group) 32,285 ★Kentucky Wonder Bean 24,575 Rich McGervey, Morgantown, WV 19,480 Jim Sparke 19,220 Vince Lok, Mississauga, Ontario 16,310 Dave Lubnow, Sussex, NJ	<b>COLOR INVADERS</b> (Computerware) 240,700 ★Roland Hendel, Mississauga, Ontario 227,050 John Osborne, Kincardine, Ontario 217,635 Jim Baker, Florissant, MO 126,350 Perry Denton, New Baden, IL 93,510 Rich McGervey, Morgantown, WV	<b>DUNKEY MONKEY</b> (Intellectronics) 3,214,200 ★Rich McGervey, Morgantown, WV 1,924,000 Andrew Herron, High Point, NC 1,679,400 Brian Jones, Story City, IA 1,618,800 Bryan Bloodworth, Federal Way, WA 1,437,200 Mike Wells, Pittsburgh, PA
<b>BIRD ATTACK</b> (Tom Mix) 306,050 ★Lenny Munitz, Bellerose, NY 200,725 Peter Niessen, Carlisle, MA 110,850 Chris Sweet, Harvard, MA 66,425 Brad Widdup, Dundas, Ontario	<b>COLOR METEROIDS</b> (Spectral Associates) 1,496,000 ★Craig Edelhelt, W. Bloomfield, MI 1,253,200 Jeff White, Prairie de Chien, WI 292,000 Roland Hendel, Mississauga, Ontario 292,000 Vince Lok, Mississauga, Ontario 297,100 Kentucky Wonder Bean	<b>FAST LANE</b> (Ace Soft Computer Products) 23,782 ★Philip Deen, Enterprise, FL 93 Marie Loos, Columbia, SC
<b>BLACKJACK</b> (Radio Shack) 7,725 ★Michael Rosenberg, Prestonburg, KY	<b>COLOR OUTHOUSE</b> (MichTron) 35,908 ★Ron Rhead, Ontario, Canada	<b>FIRECOPPER</b> (Adventure International) 113,680 ★Steve Skrzyziarz, Tacoma, WA 89,250 Robbie Black, Winnipeg, Manitoba 74,640 Cameron Amick, Reisterstown, MD 65,280 Eric Lund, Millington, NJ
<b>BLEEP</b> 105 ★Matt McMann, New Boston, MI	<b>COLORPEDE</b> (Intracolor) 10,000,000 ★Roland Hendel, Mississauga, Ontario 3,355,248 Scott Drake, Pine City, NY 2,547,299 Rich McGervey, Morgantown, WV 2,471,342 Vincent Lok, Ontario 164,051 Shane McClure, Omaha, NE 129,301 Bryan Jenner, Calgary, Alberta	<b>FLYBY</b> 20,110 ★Rick Mansell, Calgary, Alberta 4,820 ●Michael Foley, N. Quincy, MA 4,480 Jim Partridge, Clinton, CT 3,875 Darren Edamura, Kamloops, B.C. 3,670 Cameron Amick, Reisterstown, MD 2,870 David Hogue, Mercer, PA
<b>BLOC HEAD</b> (Computerware) 781,350 ★Joe Galkosky, Portage, MI 387,800 Tim Ellis, Overland Park, KS 322,425 Lindi Wolf, Fairbanks, AK 286,900 Ron Moore, Greensburg, PA 229,500 Kevin Delisle, N. Adams, MA 165,500 Tom Aliff, Jr., Northeast, MD	<b>COLOR SCARFMAN</b> (The Cornsoft Group) 976,520 ★Bruce Thornhill, Barrhead, Alberta 772,000 Keith Selfried, Greenville, OH 600,410 Roland Hendel, Mississauga, Ontario 539,100 Larry Plaxton, Medley, Alberta 530,200 Alan Klotzback, Plainesville, OH	<b>THE FROG</b> (Tom Mix) 89,910 ★James Baker, Salt Lake City, UT 79,240 Jeanne Hawkins, Deltona, FL 73,350 ●Evelyn Gagnon, Ontario, Canada 46,560 Eileen Kaakee, Royal Oak, MI
<b>BUSTOUT</b> (Radio Shack) 42,000 ★Derrick Kardos, Colonia, NJ 34,709 Sara Hennessey, Golden Valley, MN 28,720 Perry Denton, New Baden, IL 27,880 Mike Wells, Pittsburgh, PA 18,403 Brad Widdup, Dundas, Ontario 11,742 Kenneth J. Roberg, Winfield, KS 7,852 Eric Roberg, Winfield, KS 7,600 Jeff Roberg, Winfield, KS	<b>COLOUR PAC ATTACK</b> (Computerware) 472,465 ★Jim Baker, Florissant, MO 211,000 Roland Hendel, Mississauga, Ontario 210,875 Mark Nichols, Birsay, Saskatchewan 193,000 Cameron Amick, Reisterstown, MD	<b>FROGGER</b> (The Cornsoft Group) 63,800 ★Carmen Thew, Surrey, B.C. 53,965 Ian Clark, Albion, MI 32,010 Laura Schooly, Richmond, VA 25,425 Kanti Dinda, Kingston, Ontario 20,745 Felicia Schooly, Richmond, VA 16,200 Scott Ihle, Jacksonville, FL
<b>BUZZARD BAIT</b> (Tom Mix) 267,700 ★Richard Buttermore, Grand Rapids, MI 249,100 Tim Dalton, Florissant, MO 235,670 Kentucky Wonder Bean 217,800 Chris Alexander, Grand Rapids, MI 217,750 Doreen Buttermore, Grand Rapids, MI 210,850 Aaron Sentell, Maryville, TN 209,800 Jerry Ihle, Jacksonville, FL 188,500 John Enright, Wayzata, MN 158,650 Thomas A. Helm, Harvard, MA 124,750 Rick Arthur, Ballston Lake, NY	<b>CONQUEST OF KZIRGLA</b> (Rainbow Connection Software) 50,199 ★Bruce Uher, Coschocton, OH 13,155 Lee Rice, Crystal River, FL 10,389 Scott Sehnhorst, Columbia, SC	<b>FROG-MAN</b> (Computer Island) 3,735 ★Aaron T. Cincotta, Peru, IN
<b>CANYON CLIMBER</b> (Radio Shack) 4,280,200 ★Donut, Tabor, IA 4,200,200 Bart, Tabor, IA 999,900 Andre Wagner, Bangor, PA 615,500 Randy Hankins, Tabor, FL 128,800 Aaron Turnbull, Ellsworth, WI 100,200 Cliff Turnbull, Ellsworth, WI	<b>COSMIC CLONES</b> (Mark Data) 41,300 ★John Osborne, Kincardine, Ontario	<b>FROG TREK</b> (Oelrich Publications) 14,700 ★Greg Burke, Kenora, Ontario 14,080 Alan Weiss, Summit, NJ 12,800 Tom Aliff, Jr., Northeast, MD 11,200 Jim Partridge, Clinton, CT 10,370 Jim Baker, Florissant, MO
<b>CATCH 'EM</b> (Aardvark) 237,000 ★Craig Edelhelt, W. Bloomfield, MI 91,000 Dean Bouchard, Kingston, N.S. 70,157 Kirk Beler, Taber, Alberta 65,768 Laura Sandman, Louisville, KY	<b>CROSSWORDS</b> (Radio Shack) 864 ★Bob Strang, Chicago, IL	<b>FURY</b> (MichTron) 83,500 ★Hans Haimberger, Freewater, Ontario
<b>CATERPILLAR</b> (Aardvark) 180,827 ★Brian Panepinto, Spencerport, NY 86,304 Lawrence McElligott, Lancaster, CA 75,861 Michael McClure, Goose Creek, SC 63,100 Todd Byington, N. Salt Lake, UT 44,000 Scott Santatone, Tallahassee, FL	<b>DANGER RANGER</b> 732 ★Rick Arthur, Ballston Lake, NY	



**MORE...**

# RAINBOW SCOREBOARD

**PROTECTORS (Tom Mix)**

594,610 ★Roland Hendel, Mississauga, Ontario  
358,514 Cameron Amick, Reisterstown, MD  
275,810 Julian Bond, Berkeley, CA  
272,000 Douglas Hug, Roseville, CA  
217,000 Ian Waters, North Hero, VT

**PYRAMID (Radio Shack)**

200 ★Greg Burke, Kenora, Ontario  
180 Dan Burner, Fowler, FL  
180 W. Knight, Mt. Hermon, CA  
180 Lee Perkins, Norfolk, VA  
165 Dale Westmoreland, Lannon, WI

**QUASAR COMMANDER (Radio Shack)**

1,290 ★Cliff Turnbull, Ellsworth, WI

**QUEST (Aardvark)**

2,200,000 ★B.J. Bardy, Mt. Lebanon, PA  
1,000,000 Nigel Wakelin, Mt. Lebanon, PA

**RAIL RUNNER (Computerware)**

53,520 ★Jim Baker, Florissant, MO  
53,400 Ed Bottini, St. Louis, MO  
20,910 Nigel Wakelin, Mt. Lebanon, PA  
19,400 Chris Sweet, Harvard, MA  
17,325 Lenny Munitz, Bellerose, NY

**ROBOT BATTLE (Spectral Associates)**

21,000 ★Bobby Bruce, Springfield, MO

**ROBOTTACK (Intracolor)**

2,216,950 ★Randy Hankins, Tabor, IA  
2,133,050 Donul, Tabor, IA  
1,512,200 Robert Kiser, Monticello, MS  
1,424,300 John Osborne, Kincardine, Ont.  
1,219,810 Steve Skrzyniarz, Tacoma, WA

**SANDS OF EGYPT (Radio Shack)**

121 ★Grant Gillot, Calgary, Alberta  
88 Mike Rausch, Denver, CO

**SCARFMAN (Cornsoft)**

495,440 ★Woody Farmer, Alberta, Canada  
371,540 Stanley Sneed, Erwin, TN  
342,510 Jean Reit, San Mateo, CA  
121,600 M. A. Brickets, Allen Park, MI

**SEA DRAGON (Adventure International)**

75,750 ★Steve Schweitzer, Sewell, NJ  
60,430 Steve Skrzyniarz, Tacoma, WA  
27,500 Wes Hill, Vashon, WA  
23,750 Stephen Harden, Birmingham, AL

**SHAFT (Prickly-Pear Software)**

18,150 ★Loren Seng, Tuscon, AZ  
17,160 Julian Bond, Berkeley, CA

**SHARK TREASURE (Computerware)**

172,000 ★Aaron Peele, Bennington, VT  
150,000 Lori Raskob, Esalon, CA  
126,000 Curtis Boyle, Saskatoon, Saskatchewan  
72,000 Marc Hassler

**SHOOTING GALLERY (Radio Shack)**

64,900 ★Robert J. Wallace, Waldorf, MD  
52,010 ●Vernell Paterson, Radcliff, KY  
44,870 Mark Nichols, Birsay, Saskatchewan  
37,200 Chris Kulawy, St. Johnsville, NY  
37,080 Gary Long, Peru, NY

**SKING (Radio Shack)**

31,52 ★Andy Truesdale, Ferguson, MO  
35,69 Peter Johnson, Chino, CA  
40,10 Fred Herrmann, Flemington, NJ  
49,43 John Scanlan, Prairie Village, KS  
1,12,02 Tim Brown, Clio, MI

**SKY DEFENSE (Quasar Animations)**

9,700 ★Vince Lok, Mississauga, Ontario  
6,700 Mike Anheluk, Fall Creek, OR  
6,120 Steve Skrzyniarz, Tacoma, WA  
5,200 Cameron Amick, Reisterstown, MD

**SNAIL'S REVENGE (The Rainbow)**

11,380 ★Varunee Turner, Kamloops, B.C.  
4,820 Michael Rosenberg, Prestonburg, KY  
4,800 Bill Partridge, Clinton, CT  
1,610 David Figel, Sardis, OH  
910 Samuel Smith, Columbia, SC  
510 Mike Millard, Hill AFB, UT

**SOLO POKER (Radio Shack)**

830 ★Aldona Rastenis, Euclid, OH  
830 ★Fran Tucher, Albilene, TX  
670 Granville Bonyata, Tallahassee, FL  
640 Mary J. Herring, Bloomington, IL  
640 Stephen Jenkic, Pittsburgh, PA

**SOLO POOL (Tom Mix)**

110 ★Bill Steelman, Edmonds, WA  
103 John Fraysse, Dahlgren, VA  
83 Sarah Wakelin, Mt. Lebanon, PA  
83 M.A. Brickets, Allen Park, MI

**SPACE ACE (Spectral Associates)**

983 ★Matt McMann, New Boston, MI

**SPACE AMBUSH (Computerware)**

403,350 ★Jimmy Chan, Kincardine, Ontario  
124,460 John Osborne, Kincardine, Ontario

**SPACE ASSAULT (Radio Shack)**

1,632,450 ★Walter Brox, Granisle, BC  
358,660 Mike Snelgrove, Oshawa, Ontario  
238,580 John Cole, King City, Ontario  
224,130 Derrick Kardos, Colonia, NJ  
221,130 Steve Johnson, Santa Ana, CA

**SPACE INVADERS (Spectral Associates)**

1,496,030 ★Jimmy Chan, Kincardine, Ontario  
62,300 Peter Niessen, Carlisle, MA  
54,980 Susan Brink, Portage, MI  
53,930 Linda Delisle, N. Adams, MA  
29,560 Greg Brink, Portage, MI

**SPACE RACE (Spectral Associates)**

83,750 ★John Osborne, Kincardine, Ontario  
62,875 Shane Delke, Bolme, TX  
59,825 Jim Baker, Florissant, MO  
58,100 John Cole, King City, Ontario  
55,625 Steve Skrzyniarz, Tacoma, WA

**SPACE RAIDERS (Mark Data)**

112,100 ★Jimmy Chan, Kincardine, Ontario

**SPACE SENTRY (Spectral Associates)**

41,129 ★Steve Skrzyniarz, Tacoma, WA  
2,625 Cameron Amick, Reisterstown, MD

**SPACE SHUTTLE (Tom Mix)**

595 ★Steve Schweitzer, Sewell, NJ  
575 Fred Weissman, Brookline, MA  
571 Ted McDonald, Summerville, SC  
566 Tim Smith, San Rafael, CA  
562 Kenton Fifield, Ft. Frances, Ontario

**SPACE WAR (Spectral Associates)**

400,190 ★Mark Felps, Bedford, TX  
116,000 Peter Niessen, Carlisle, MA  
52,300 Jim Baker, Florissant, MO  
46,870 Chris Leek, Martintown, Ontario  
11,540 David Iverson, Dorval, Quebec

**STARBASE ATTACK (IMB)**

328,000 ★Paul Morris, Richland, VA  
62,551 Chris Coyle, Selden, NY  
60,602 Beth Walker, Gloucester Pt., VA  
35,659 Dennis Teague, Noblesville, IN  
24,688 J.W. Pank, Noblesville, IN

**STARBLASTER (Micro Works)**

408,245 ★Mark Dowling, San Bruno, CA  
325,790 Mike Anheluk, Fall Creek, OR  
126,135 Mike Hall, Hartland, WI  
113,450 Darren Noranyan, Oswego, NY  
60,001 Alan Lewis, Ridgefield, CT

**STARFIRE (Intellectronics)**

10,000,000 ★Roland Hendel, Mississauga, Ontario  
3,444,500 John DeMuth, Prairie de Chien, WI  
2,102,450 Dean Bouchard, Kingston, N.S.  
1,420,000 Steve Schweitzer, Sewell, NJ  
1,000,050 Chuck Ladig, Suisun City, CA

**STARSHIP CHAMELEON (Computerware)**

861,200 ★Greg Leshner, North Chili, NY  
82,200 Chris Sweet, Harvard, MA  
79,250 Vince Lok, Mississauga, Ontario  
75,500 Ron Pinson, Guelph, Ontario  
72,600 Jim Baker, Florissant, MO

**STARTREK (Adventure International)**

90 ★Scott Sanlarone, Tallahassee, FL

**STORM (Computerware)**

840,010 ★Roland Hendel, Mississauga, Ontario  
723,335 Chris Sweet, Harvard, MA  
472,320 John Jaworski, Nashua, NY  
360,000 Cameron Amick, Reisterstown, MD  
312,000 Dave Lubnec, Sussex, NJ  
63,415 Rip Loomis, Long Beach, MS

**STORM ARROWS (Spectral Associates)**

94,000 ★Steven Ohsie, Houston, TX  
22,200 Cameron Amick, Reisterstown, MD

**TEEEOFFF (Prickly-Pear Software)**

32 ★Mark Wright, Tipton, MI

**TRAPFALL (Tom Mix)**

113,408 ★Rich Trawick, N. Adams, MI  
104,456 Robert Caltral, Ottawa, Ontario  
104,368 John Osborne, Kincardine, Ontario  
98,588 Dan Burch, Louisville, KY  
96,800 Bruce March, Barrie, Ontario

**TUBE FRENZY (Aardvark)**

98,640 ★David Hogue, Mercer, PA

**VENTURER (Aardvark)**

4,126,200 ★Greg Scott, Orlando, FL  
2,291,100 Mike Silzer, Roslyn, NY  
2,657,350 Brian Panepinto, Spencerport, NY  
1,769,400 Todd Hauschildt, Red Wing, MN

**WACKYFOOD (Arcade Animation)**

130,100 ★Lenny Munitz, Bellerose, NY  
110,300 Bette Munitz, Bellerose, NY  
99,900 Sheri Munitz, Bellerose, NY  
42,800 Saul Munitz, Bellerose, NY

**WHIRLYBIRD RUN (Spectral Associates)**

516,450 ★Dan Shargel, Arroyo Grande, CA  
103,900 Dann Fabian, Crestview, FL  
98,400 Dave Lubnow, Sussex, NJ  
48,000 Todd Brannan, Charleston Hts., SC  
38,600 Darren Noranyan, Oswego, NY  
30,250 Chris Cope, Central, SC

**WILDCATTING (Radio Shack)**

56,934 ★Michael Rosenberg, Prestonburg, KY  
48,682 ●David Rodgers, Carbondale, IL  
30,555 Gary Jones, Dale, TX  
29,854 Matt Bust, Bangor, PA

**ZAKSUND (Elite Software)**

1,128,050 ★Richard Minton, West Frankfort, IL  
1,008,100 Andy Mickelson, Granville, OH  
950,500 Michael Rothman, Solon, OH  
910,000 Steve Schweitzer, Sewell, NJ  
876,200 John Osborne, Kincardine, Ontario

**ZAPEM (Chromasette)**

12,950 ★Michael McCallferty, Idaho Falls, ID

**ZAXXON (Datsoft)**

2,000,000 ★Roland Hendel, Mississauga, Ontario  
1,510,000 James Quadarella, Brooklyn, NY  
401,900 Mike Hughey, King George, VA  
370,400 Chris Coyle, Selden, NY  
235,200 Rich McGervey, Morgantown, WV  
116,200 Jerry Ithe, Jacksonville, FL  
77,800 Jeffrey Gaut, III, Altoona, PA  
76,300 Buddy Ferguson, Trenton, IL

**ZERO G (Chromasette)**

19,735 ★Michael Foley, N. Quincy, MA

# Adventuring With Style

By Bob Liddil

*Be cautious, and remember . . . the word is everything.*

**H**ere's Joe Adventure, preparing for another all night session at the keyboard. We go down the checklist, point by point, making sure that nothing is left out.

Coffee, ten gallons. Check. Sunglasses to protect eyes from screen glare. Check. Phone off hook. Check. Wife and kids on bus to Toledo. Check. Shades pulled, dictionary and thesaurus nearby. Check. One copy of *Attack Of The Killer Dragon That Ate New Jersey*, CoCo version. Check.

Right! Now we begin.

As Joe plunges forward in this, his 17th attempt to solve this computerized version of kill the customer by driving him insane, we shall examine the wonderous phenomenon known as Adventure. Note the capital A which is accorded the genre by true affectionados.)

As long as there has been man there has been Adventure. Oog, prehistoric cave guy, first discovered this unique experience when he whacked a Tyrannosaur with a tree limb and then tried to run into a cave. Unfortunately, GO CAVE was executed before MOVE BOULDER and poor Oog became the first dinosaur TV dinner.

All through history, man has been locked in blind pursuit of elusive Adventure. The books are filled with examples of brave heroes who entered the wrong commands. There was Captain Vladimir Vaselescov, for example, whose burning desire to become the first Russian to reach the North Pole by sailing south caused him to EXAMINE PENGUIN without WEARING GLOVES. Vaselescov became the first explorer ever to die in a penguin stampede. If he'd seen the ribbon she was wearing, he would have realized she was the only female penguin in the entire Antarctic, thus avoiding an unnecessary stomping.

---

*(Bob Liddil, Captain Eighty, is a well-known writer on Color Computer topics who has numerous columns and several books to his credit.)*

Computer art imitates life. While the picturized Adventures dilute the impact of different interpretations of the same phrase, the true text Adventure leaves everything to the imagination. In Adventure, the word is everything.

A simple statement: YOU SEE — HAND GRENADE, PEN, BOX becomes a nightmare of possibilities. The verb-noun combinations which make up the command structure and allow interaction with the program can be manipulated by the author with ease.

EXAMINE. Okay, do that to the grenade. Computer says, YOU CAN'T DO THAT . . . YET. Curses! You are committed. GET HAND GRENADE. Computer says OK. EXAMINE it now? Computer says it is ticking. *Well, there's a pen*, but it's spelled wrong so it may not fit. Typing HELP may or may not render assistance. If you DROP it you may get blown up. Better THROW GRENADE. Computer says GRENADE EXPLODES. We anticipated that. LANDS IN PEN AND EXPLODES says the computer. IN the PEN? PEN turns out to be PIG PEN and now there is enough bacon to last your whole journey. All you need is eggs and juice and you'll satisfy government requirements for a balanced Adventure.

As every Adventurer discovers, the author is in the full control of the scenario at all times. In order to solve the puzzle the user must be prepared to *think like the author*. Indeed, he must BECOME the author as he works his way into the depths of the game.

Different authors approach Adventure in different ways. There is the hardnose, or high tech, style. In *Sands of Egypt*, we have an author engaged in the grim business of totally stumping the player. This game plays like shooting BB rifles on the midway at a county fair; very few hits and a nearly unattainable goal. This style is a play for the ride. Winning is a brass ring. The high tech style is most suitable for the very smart, the very patient, and the emotionally stable Adventurer, or for someone with a fully insured computer.



# ENDICOTT COMPUTER SOFTWARE AND ACCESSORIES



## TAPE CAROUSEL

Holds up to 25 cassettes in individual compartments. Units are stackable and revolve for easy access. Clear plastic sliding covers keep tapes dust-free (tapes not included). Great for your stereo too!

~~\$15.00~~ EACH     \$13.00 EACH

## JOYSTICK

\$19.95  
EACH



\$37.95  
FOR TWO

"In use, we found the ENDICOTT JOYSTICK to be smooth and responsive. ...built to last, the Endicott model is a solid buy".  
*the RAINBOW, October 1982*

"...provided the best feel of all the joysticks tested. ...a rugged unit at an affordable price."  
*-80 micro, March 1983*

## SUPER-PRO KEYBOARD

by MARK DATA PRODUCTS



Smooth professional touch. Identical keyboard layout eliminates relearning key locations. Simple installation! No soldering or wiring. Professional appearing installation. Computers made after or about Oct. 1982 require adapter.

KEYBOARD: \$69.95  
**SPECIAL! \$64.95**  
ADAPTER: \$4.95

## FLIP'N'FILE

by Innovative Concepts

Holds 10  
Diskettes ..... ~~\$ 5.95~~     \$ 5.45  
Holds 25 Diskettes  
With Lock ..... ~~\$28.95~~     \$24.95  
Holds 50 Diskettes  
With Lock ..... ~~\$39.95~~     \$33.95



## VIDEO 300

by Amdek



VIDEO 300 (Green): 13" Non-glare screen.  
With Video Plus (See Below) ..... \$190.00  
W/O Video Plus ..... \$170.00  
VIDEO 300 (Amber): 13" Non-glare screen  
With Video Plus (See Below) ..... \$205.00  
W/O Video Plus ..... \$185.00

## COLOR 1+

by Amdek

COLOR 1+: 13" Composite Color Monitor with new non-glare screen, built in audio circuit, speaker, and plug-in adjustable head set

WITH VIDEO PLUS (SEE BELOW) ..... \$360.00  
W/O VIDEO PLUS ..... \$340.00



## OKIDATA 82A

A heavy duty printer that can run all day. It has friction and pin feed with rear or bottom paper feed.

W/CoCo Serial/Parallel Interface (See Below) ..... \$490.00  
W/O Interface ..... \$430.00



## SPIRIT

by Mannesmann Tally

A new top quality printer with the same commands as Epson including graphics at a reasonable price. Friction and adjustable sprocket feed included.

With CoCo Serial/Parallel Interface (See Below) ..... \$425.00  
W/O Interface ..... \$365.00



## GORILLA/BANANA

Comparable to the DMP100 Printer. Built in serial interface. Includes special cable for CoCo. Nothing else to buy.

With cable ..... \$265.00  
Parallel Printer with CoCo Serial/Parallel Interface (See Below) ..... \$305.00  
Just Printer (Specify Parallel or Serial) ..... \$245.00

## pbh CoCo Serial/Parallel Interface

- Switch Selectable Baud Rates From 300 to 9600
- Switch Selectable Printer or Modem Operation (Connections Provided for BOTH).
- Self Contained Power Supply
- Nothing Else Needed ~~\$74.95~~ \$69.96

## VIDEO PLUS

by Computerware

Composite video monitor interface. Allows use of composite color or monochrome monitors. Easy to install, no soldering, case must be opened. Does not disable your TV interface. Works with all CoCos.

Fully Assembled and Tested ..... \$24.95

## KALGLO SURGE SUPPRESSORS/FILTERS

Deluxe (8 outlets) ..... \$79.95  
Quad (4 outlets) ..... \$61.95  
Mini (2 outlets) ..... \$45.95

# WE PAY SHIPPING!

Other companies ask you to ADD \$1, \$2, \$3 or more for shipping  
**WE NEVER DO to U.S.A., CANADA, MEXICO.**

Add \$2.00 C.O.D. (U.S.A. Only). Allow 2 weeks for check to clear.  
 No P.O. Boxes please! We must have your street address.

SHIPPING-ALL OTHER COUNTRIES: Add \$2.00 for each software item and each joystick.

Add \$5.00 for all other items (no monitors or printers shipped outside U.S.A.). Items will be shipped air mail.

Prices apply to mail orders only - All sales final - No returns unless defective.

Look at These Software Discounts and Compare...Remember **WE PAY SHIPPING!**

**15% OFF** LIST PRICE OF ONE,  
TWO OR THREE

**20% OFF** LIST PRICE  
OF FOUR OR MORE

## CUSTOM SOFTWARE ENGINEERING

★ DISK DATA HANDLER..... \$54.95  
 (SUPPLIED ON TAPE)

## SPECTRAL ASSOCIATES

	T	D
★ CUBIX .....	\$24.95	\$28.95
★ LANCER .....	\$24.95	\$28.95
★ MS GOBBLER .....	\$24.95	\$28.95
WHIRLYBIRD RUN .....	\$24.95	\$28.95
STORM ARROWS .....	\$24.95	\$28.95
LUNAR ROVER PATROL .....	\$24.95	\$28.95
SPACE SENTRY .....	\$18.95	\$22.95
PLANET INVASION .....	\$24.95	\$28.95
ALPHA SEARCH .....	\$24.95	\$28.95

## COMPUTERWARE

	T	D
★ JUNIOR'S REVENGE .....	\$28.95	\$31.95
★ TIME PATROL .....	\$24.95	\$29.95
★ HYPER ZONE .....	\$26.95	\$29.95
★ COLOR BASIC COMPILER .....	-	\$39.95
64K SCREEN EXPANDER (64K) .....	\$24.95	\$27.95
*THE SOURCERER .....	\$34.95	\$39.95
★ DISK MACRO ASSEMBLER & XREF .....	-	\$49.95
★ COLOR EDITOR .....	\$24.95	\$29.95
★ COLOR MONITOR .....	\$24.95	\$27.95
★ MOON HOPPER .....	\$24.95	\$29.95
BLOC HEAD .....	\$26.95	\$29.95

## ELITE SOFTWARE

	T	D
ELITE-WORD .....	\$59.95	\$59.95
ELITE-CALC .....	\$59.95	\$59.95

## COGNITEC

	T	D
TELEWRITER 64 .....	\$49.95	\$59.95

## ANTECO SOFTWARE

	T	ROM PK
8-BALL (POOL) .....	-	\$29.95
PINBALL .....	\$24.95	\$29.95

## DATASOFT

	T	D
ZAXXON .....	-	\$39.95

## PROGRAMMERS INSTITUTE

	T	D
★ COLOR ACCOUNTANT .....	\$74.95	\$79.95

## PRICKLY-PEAR SOFTWARE

	T	D
ADVENTURE IN WONDERLAND .....	\$24.95	\$29.95
THE DISK MANAGER .....	-	\$29.95
THE DISK MASTER .....	-	\$24.95
*VIKING .....	\$19.95	\$24.95
*GANGBUSTERS .....	\$19.95	\$24.95
COLORKIT .....	\$29.95	\$34.95

## TOM MIX

	T	D
★ CU*BER .....	\$27.95	\$30.95
★ BUZZARD BAIT .....	\$27.95	\$30.95
★ AIR TRAFFIC CONTROLLER .....	\$28.95	\$31.95
THE FROG .....	\$27.95	\$30.95
★ SPACE SHUTTLE .....	\$28.95	-
★ DONKEY KING .....	\$26.95	\$29.95
★ COLOR GOLF .....	\$17.95	-
TRAP FALL .....	\$27.95	\$30.95

## SOFT LAW

	ROM	D
VIP WRITER .....	\$59.95	\$59.95
VP SPELLER .....	-	\$49.95
VIP CALC .....	\$59.95	\$59.95
VIP TERMINAL .....	\$49.95	\$49.95
VIP DATA BASE .....	-	\$59.95
VIP DISK-ZAP .....	-	\$49.95

## ADVENTURE INTERNATIONAL

	T	D
*FIRE COPTER .....	\$24.95	-
*SAIGON: THE FINAL DAYS .....	\$24.95	-
*EARTHQUAKE .....	\$24.95	-
*AIRLINE .....	\$24.95	-
*SEA DRAGON .....	\$34.95	-
*TRIAD (Avail. Jan) .....	\$34.95	-
★ DISKEY (Disk Access & Repair Kit and Computer Diagnostics) .....	-	\$49.95

Additional listings in our free catalog - call or write.

\*Requires 16K Ext. Basic Minimum    ★ Requires 32K Ext. Basic Minimum  
 Others 16K Std. Basic Minimum

## GRAND OPENING!

Come visit our new store  
 in Huntsville, Alabama

We also support:

TRS-80 (Mod 1, 3 & 4) Commodore 64

Apple Vic 20

Franklin Atari

Computers available for  
 software demonstration.

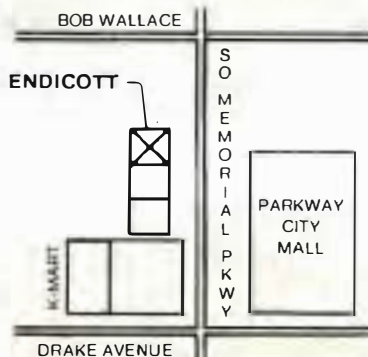

# ENDICOTT

Computer Software  
 and Accessories

2806-A S. Memorial Parkway  
 Huntsville, AL 35801  
 (205) 536-4400



Phone Open 7 Days a Week

The classic style is easier to swallow. A classic is usually goal oriented with pieces of the puzzle scattered about and fitting neatly together to form a solution. The text Adventure *Dragonquest* occupies this opposite end of the scale from the frustration (challenge) of high tech. Users can easily tune in the young Charles Forsythe as he guides them through Lower Graylockland in search of Smaegor the Princess Snatcher. He has provided tools for the win, without denying all but the most clever access. Instead, he makes the overall problem, rescuing the princess, the most difficult. The tools needed are sub-puzzles simply solved. There are a few tense moments at the beginning when the King refuses to allow the player to leave the castle. But the keywords can be worked out without the help of a Harvard professor. By the way, what is a MANATEE? And would you go swimming in the same river with one?

The flip style or the irreverent style, if you prefer, employs elements of the other two. Gamster Software's *Madame Rosa's Massage Parlor*, which is about as naughty as a bikini calendar, provides endless word twists and blind alleys caused by letting the imagination run wild. But, at the same time, it is very classic in its goal orientation. *Madame* is tough, but not unwinnable. More importantly, it is 16K of belly laughs. Author Bob Krotts pokes fun at the whole Adventure genre and gives the player something to do other than slay dragons or escape deadly traps.

Each of the three styles mentioned makes specific demands on the audience. High tech requires literal interpretation and cunning logic, an almost telepathic draw on the author's intent. Classic is more story oriented with goals plainly defined. Flip plays to the sense of humor and the user's willingness to be manipulated or led astray in the name of comedy. The later two can be won with effort and patience. The first requires an iron will, a master's in parapsychology and a loving, understanding family. A strong local mental health office should be a consideration also.

There are roughly 10 Adventure titles for every "Twitch" (arcade game). This is attributable in part to the ease of coding and divergence of thematic possibilities, versus the logistics of animation. Not all of these make it to market. There can be found on BBS's and in private uploading clubs tens of hundreds of Adventure programs placed in the public domain by first authors anxious for approval from their peers.

Commercially, the variety is overwhelming. *Calixto Island* from Mark Data shares the line with several highly animated and well-planned programs. Prickly-Pear's *Adventure in Wonderland* employs the still experimental sentence-style command mode and explores a very popular classic children's story. *Sands of Egypt*, *Black Sanctum*, *Dragonquest*, *Beyond the Cimeeon Moon*, the list reads on and on, like the titles in a fiction library, each trying to outdo the other in cleverness and plot.

Beyond all this, whether the program is illustrated or pure text, you will find the written word. The bottom line in Adventure is reading comprehension. I believe, based on this fact alone, that Adventure is the ideal computer game for kids (and adult alike). Even with all the motor skills that are developed with

the Twitch, there can be no more valuable exercise to anyone than reading. For the micro-computerist gamer, there can be no challenge greater than that of one mind pitted against another; no teamwork more satisfying than friends, as a group, solving a killer puzzle.

And what of Joe Adventure?

It's five o'clock in the morning. Joe has to go to work at nine. He's taken the sword from the stone. He knows where the dragon is hiding. He's even made it through the dark woods. But the HELP command's been giving conflicting answers all night. The coffee's cold, he's been in the river twice and a question burns in the gray of the pre-dawn.

"Pray tell me, Sir Author," he laments, "what DOST thou feed to a MANATEE?"

**SPEED  
LIMIT  
FAST!**

**FAST!  
DATA I/O  
PRINTING  
DELIVERY**

**\$29<sup>95</sup>**

\$2 SHIPPING

**8010X  
INTERFACE**

GEMINI-10X TO COLOR COMPUTER  
110-9600 BAUD  
CABLE INCLUDED



**\$319<sup>95</sup>**

+ SHIPPING

**GEMINI-10X**

WITH

**8010X INTERFACE**

180 DAY  
WARRANTY

CABLE AND SCREEN PRINT SOFTWARE INCLUDED  
READY TO PLUG IN / NOTHING MORE TO BUY

OHIO RESIDENTS ADD 6% TAX

**DAYTON ASSOCIATES • 7201 CLAIRCREST DR., BLDG. C  
DAYTON, OHIO 45424 • (513) 236-1454**



<b>Adventure Starter Package</b>	
Great Fun For Beginning Adventurers/ <i>Owl's Nest Software</i> .....	242
<b>Arabic Numbers: Roman Numerals</b>	
When In Rome Count In Roman Numerals/ <i>Moreton Bay Software</i> .....	222
<b>Banners Banners Banners</b>	
A Colorful Large-Character Generator/ <i>All-American Ultralight Industries</i> .....	240
<b>Battle</b>	
A Little Game That Grows On You/ <i>Aurora Software</i> .....	222
<b>The Byte Bat</b>	
A Good Way To Get Even/ <i>Micro Tie Systems</i> .....	224
<b>CCP-1 Serial Interface</b>	
Both A Beauty And A Beast/ <i>Botek Instruments</i> .....	272
<b>Cashman</b>	
A Fun Investment/ <i>MichTron</i> .....	256
<b>Clock Drill</b>	
An Educational, Timely Tool/ <i>CY-BURNET-ICS</i> .....	252
<b>Color Tutor</b>	
A Meat And Potatoes Utility/ <i>Elite Software</i> .....	228
<b>The Complete Personal Accountant</b>	
An Excellent Financial Package/ <i>Programmer's Institute</i> .....	246
<b>Cookie Monster's Letter Crunch</b>	
Spelling Is D-e-l-i-c-i-o-u-s/ <i>Radio Shack</i> .....	266
<b>DDH Directory-File Builder</b>	
An Enhancement For Disk Data Handler/ <i>Custom Software Engineering</i> .....	220
<b>Disk Colorcom/E Version 2</b>	
An Easy Way To Get Connected/ <i>Spectrum Projects</i> .....	232
<b>Diskey</b>	
Cures The Suffering From Disklock/ <i>Adventure International</i> .....	251
<b>Dyterm</b>	
A Good Program With Tough Documentation/ <i>Dynamic Electronics, Inc.</i> .....	216
<b> Euchre</b>	
An Entertaining Card Game Of Tricks/ <i>Chroma Systems Group</i> .....	244
<b>Face</b>	
Speaks To The Young/ <i>Childish Software</i> .....	265
<b>FICA-83</b>	
What Will Your Social Security Benefits Be?/ <i>Parsons Software</i> .....	278
<b>Gorilla Banana GX-100 Printer</b>	
Both A Beauty And A Beast/ <i>Spectrum Projects</i> .....	272
<b>The Great Hamster Hunt</b>	
It's Even Fun For Fathers/ <i>Computer Island</i> .....	236
<b>Ice Master</b>	
A Refreshing Change Of Pace/ <i>Arcade Animations, Inc.</i> .....	217
<b>Journey To Mount Doom</b>	
A Good Disk Based Adventure/ <i>Tom Mix Software</i> .....	250
<b>Jowst</b>	
Fowl Play Is Fair/ <i>ThunderVision</i> .....	276
<b>Key-264K</b>	
The Key To Flexible Programming/ <i>Key Color Software</i> .....	260
<b>Kron</b>	
Well-Conceived, 'Rates With The Best'/ <i>Oregon Color Computer Systems</i> .....	270
<b>MM-100 Mini Modem</b>	
An Easy Way To Get Connected/ <i>Spectrum Projects</i> .....	232
<b>Mansion Of Doom</b>	
A Fun, High Quality Adventure/ <i>Pal Creations</i> .....	230
<b>The Micronix Premium Keyboard</b>	
The Finger-Walking Keyboard/ <i>Micronix Systems Corp.</i> .....	238
<b>Order Entry System</b>	
Provides Sales Help/ <i>Mark Data Products</i> .....	254
<b>Pager/64K Boot</b>	
Two More Utilities For CoCo/ <i>Skyline Marketing</i> .....	245
<b>Rubicon II</b>	
Patton Would Have Loved It/ <i>Ark Royal Games</i> .....	264
<b>Screen Reference Card</b>	
Is No Ace/ <i>CoCo Data Enterprises</i> .....	234
<b>Tee Off</b>	
A Challenging Round Of Micro Golf/ <i>Prickly Pear Software</i> .....	227
<b>Time Patrol</b>	
A Fun Way To Spend Some Time/ <i>Computerware</i> .....	242
<b>VC</b>	
War Game Called Good Simulation/ <i>Avalon Hill Game Co.</i> .....	221
<b>Valhalla</b>	
A Very Good War Game/ <i>Hycomp</i> .....	214

# RECEIVED & CERTIFIED

The following products have been recently received by *the Rainbow*, examined by our magazine staff and approved for the *Rainbow Seal of Certification*, your assurance that we have seen the product and have ascertained that it is what it purports to be.

This month the *Seal of Certification* has been issued to:

**The Answer**, a hardware device that plugs into your ROM port. It features: ROM Pack port splitter; auto-execute and select switches; an LED indicator; parallel I/O ports; parallel printer driver; COCOTERM (a built-in smart terminal program); and a built-in color monitor. Midwest CoCo Systems, 1800 W. 91st Pl., Kansas City, MO 64114, \$179.95

**Atom**, a 16K Program Pak, designed to introduce your child to the exciting subatomic world of elements. The object is to build an atom of each of the 54 elements available in the game as quickly as possible. At the same time, your child will be learning the name of each new element, its atomic number and configuration, and its main property. As the player improves and completes the structures of the atoms, the atoms become more complex and less time is given to construct the next atom. Radio Shack stores nationwide, cat. number 26-3149, \$19.95

**BASIC Made Easy**, by Don Cassel and Richard Swanson, a 240-page guide to programming microcomputers and minicomputers. This book is an introduction to BASIC at the level of the first time user. It assumes no background in either computing or programming and begins by introducing the reader to the various components of a computer system. Features include: an introduction to *mini-and* microcomputers; using flowcharts to solve programming problems; BASIC programming fundamentals, etc. Reston Publishing Company, Inc., 11480 Sunset Hills Rd., Reston, VA 22090, \$15.95

**CoCo-Bingo**, a version of the popular game of Bingo which is designed to run on the CoCo, TDP100 and Dragon computers. Includes playing cards and plastic chips. You can play regular Bingo, Double Bingo (two Bingos on same card) or Coverall Bingo. Colortech Systems, 17401 Darmouth Ave., Cleveland, OH 44111, tape \$12.95

**Colorcom/E Smart Terminal Package**, a package which includes: Mini Modem Model MM-100; a CoCo RS-232 modem cable; and the Colorcom E. The Mini Modem is a self-contained FSK (frequency shift keying) telephone interface that allows computers to communicate with each other over ordinary telephone lines. It is compatible with all Bell 103-type modems. Features include: sending/receiving at 0-300 Baud for compatibility with most time-shared computer systems; selectable originate/answer mode for operation in "remote" or "host" terminal applications; full duplex operation which allows simultaneous communication between mo-

dem, etc. The package also includes the **Colorcom/E** — a smart terminal program that uploads and downloads files. The **CoCo RS-232 modem cable** is also included. It is a 4-Pin din to a DB 25 plug. Spectrum Projects, 93-15 86th Drive, Woodhaven, NY 11421, \$114.85

**Color Designer**, a graphics processing tool to create graphic characters, shapes, and especially to create entire graphic screens. It includes an eight-key cursor control with key repeat, a *FILL* command that paints the screen with more than 1000 different color/texture combinations, and much more. Color Connection Software, 1060 Buddlea Dr., Sandy, UT 84070, tape \$26.95, disk \$28.95

**Colorsoft Accounts Receivable**, a full stand-alone accounts receivable system. It is suited for the **Colorsoft Small Business Accounting Package**. This program provides the user with detailed audit trails and history files on all transactions by a customer. It also prepares invoices, mailing labels, aging lists, customer history reports, and an alphabetized customer listing. The user can define discount/net terms for commercial accounts and finance charge and minimum payments for revolving accounts. Requires 16K and a single disk drive. Brantex, Inc., Color Software Services Div., Business Software Group, P.O. Box 1708 Dept. R, Greenville, TX 75401, \$89.95

**Colorsoft Payroll**, a complete stand-alone package for maintaining personnel and payroll data on the employees of a small business, calculating payroll and tax amounts, and maintaining year-to-date totals for income tax reporting. This system will compute each pay period's totals based on hours worked, calculate taxes to be withheld, allow for specified deductions, compute net pay and prepare a mailing list. Additional reports that are produced include a listing of employees, a year-to-date federal/state tax listing, and miscellaneous deductions. It is also suited for integration into the **Colorsoft Small Business Accounting Package**. Suited for use in all states except Oklahoma and Delaware. Requires 16K and a single disk drive. Brantex Inc., Color Software Services Div., Business Software Group, P.O. Box 1708, Dept. R, Greenville, TX 75401, \$99.95

**Colorsoft Small Business Accounting**, an integrated, ledgerless accounting package for a small business that includes accounts payable, accounts receivable, sales and purchase order programs. Outputs of the system include an income statement, balance sheet, check register, accounts payable and receivable status lists, and accounts payable and

receivable aging reports. During each user established accounting period (monthly, quarterly, annually, etc), it will handle sales of up to \$1,000,000 and approximately 800 accounts payable (receivable). Requires 16K and a single disk drive. Brantex, Inc., Color Software Services Div., Business Software Group, P.O. Box 1708, Dept. R., Greenville, TX 75401, \$149.95

**Compucards**, computerized greeting cards. Use your computer to send a personal message to everyone on your Christmas list. Includes 20 illustrated, colorful cards and envelopes. Compucards, P.O. Box 894, Stone Mountain, GA 30086, \$9.95

**The Computer Phone Book** by Mike Lane, is a comprehensive paperback directory of all online databases for personal computer users. This 466-page guide is a complete annotated listing of names and numbers so you can go online with over 40 systems across the country. It features free software, electronic mail, computer games, consumer catalogs, stock market reports, medical data, dating services and more. New American Library, 1633 Broadway, New York, NY 10019, \$9.95

**Christmas Quiz**, a true/false, multiple choice question and answer game. This educational program is based on the gospel's account of the virgin birth of Jesus Christ (Matthew and Luke are the major sources). Quality Christian Software (QCS), P.O. Box 1899, Duncan, OK 73533, tape \$9.99

**Crazy Painter**, a ML arcade game for the Dragon 32 with eight skill levels. Paint the floor, but look out for dogs, snakes, painters' mates, paint eaters and turpentine bubbles. Microdeal LTD., 41 Truro Road, St. Austell, Cornwall, PL25, 5JE, tape \$12

**Cuthbert Goes Digging**, a ML game for the Dragon 32. Fight the Moronians on the galactic building site. Microdeal LTD., 41 Truro Road, St. Austell, Cornwall, PL25, 5JE, tape \$12

**Cuthbert In The Jungle**, a ML arcade game for the Dragon 32. Fight your way through the jungle collecting treasures, jumping pits and swinging across alligators while being aware of the killer scorpion in the basement. Microdeal LTD., 41 Truro Road, St. Austell, Cornwall, PL25 5JE, tape \$12

**Diskette Carousel**, a compact, mini-floppy storage system that organizes up to 72 mini-floppies in protective, color-coded envelopes. Envelopes slip in and out of individual slots in carousel with ease. The precision rotary movement provides easy access to all flopp-

pies in a matter of seconds. Inland "Data Pak" Corp., Madison Heights, MI 48071, \$29.95

**Education Pack 2**, a 16K or 32K three-package program (to be used with **The Voice** hardware speech synthesizer) intended for the elementary school child. Includes *Hangman* — **The Voice** adds a new dimension to this spelling game; *Spelling* — Test your spelling ability with **The Voice**; and *Calendar* — Test your knowledge of the days of week, months, etc. Speech Systems, 38W255 Deerpath Rd., Batavia, IL 60510, cassette or disk \$24.95

**Esther**, a 32K machine language program (to be used with **The Voice** hardware speech synthesizer), which illustrates the high level of artificial intelligence computers have achieved. This is a similar version of *Eliza*, a program developed at MIT in which the computer plays psychologist. Speech Systems, 38W255 Deerpath Rd., Batavia, IL 60510, cassette or disk \$24.95

**Filebox/16**, a home filing system for the 16K CoCo and a disk drive. Create, change update, delete, sort and list files you define. Applications are virtually unlimited. Use for address lists, car repair records, household inventories, book and record collections, tax records, etc. You can also use it to sort mailing labels. Each record can contain up to 10 fields and 256 characters. It is completely menu-driven and contains a 20-page user's guide. Circling Star Software, P.O. Box 1218, Freehold, NJ 07728, \$29.90

**Galactic Taipan**, a 32K ECB space strategy game. As a trader, you must battle space storms, pirates and high taxes in the hopes of making a profit in the galaxy. Ark Royal Games, P.O. Box 14806, Jacksonville, FL 32238, tape \$24.95

**Graphic Screen Print Program (GSPRB)**, a 16K/32K program for use with the TRS-80 Color Computer and **Gorilla Banana Printer**. Requires an eight bit serial interface—no print driver included. Custom Software Engineering, Inc., 807 Minuteman Causeway (D-2) Cocoa Beach, FL 32931, tape \$9.95

**Intergalactic Force**, a ML arcade game for the Dragon 32. You are in charge of a starship and your mission is to destroy the alien invaders. Microdeal LTD., 41 Truro Rd., St. Austell, Cornwall PL25 5JE, tape \$12

**Keys Of The Wizard**, a ML Adventure game for the Dragon 32. This Adventure is randomized so that no two games are ever exactly the same. Find all the treasures and store them safely in the sanctuary, while fighting off the creatures which can attack anytime, and avoiding traps and tricks. Microdeal LTD., 41 Truro Rd., St. Austell, Cornwall, PL25 5JE, tape \$12

**Learning BASIC Fast**, (revised edition) by Claude J. DeRossi, a 211-page, easy-to-read guide emphasizing simple, concise explanations of computer systems, flowcharts, and the important commands used in BASIC. This book teaches a beginner to learn the language of BASIC in 12 to 15 hours. It provides exercises, definitions and sample programs. Reston Publishing Company, Inc., 11480 Sunset Hills Rd., Reston, VA 22090, \$15.95

**Musica**, a machine language, four-voice music program which automatically adjusts to 16K or 32K machines. Features: the notes are displayed on the screen in Hi-Res graphics; treble and bass staves are shown individually; notes are input using keyboard arrow keys or joysticks; you can develop an unlimited number of timbre definitions using a superfast waveform synthesis option, etc. Speech Systems, 38W255 Deerpath Rd., Batavia, IL 60510, tape \$34.95, disk \$39.95

**Ockywocky**, a 32K ECB game. There's a double-agent in the organization code named Ockywocky. Your job is to identify him/her but it won't be easy! You don't have much time and it can be any one of 32 suspects. Travel to exotic capitals, contact informants, scrutinize dossiers... all in your quest. Include dossiers and suspect check-off pad. Shooting Star Software, P.O. Box 24, Chico, CA 95927, disk \$24.95, tape \$22.95

**Quiz All**, a versatile quiz program which provides study and test formats and allows printing of quizzes. It also includes an option for the computer to generate multiple choice answers. Color Connection Software, 1060 Buddlea Dr., Sandy, UT 84070, tape \$18.95, disk \$20.95

**Starblazer**, a 32K ECB galactic strategy game. During your absence, the Spectrum galaxy has been overrun by the draconic xyclons. Now you command the only starship left to destroy all invaders: xyclon patrols, vessels and mother ships. Ark Royal Games, P.O. Box 14806, Jacksonville, FL 32238, tape \$24.95

**The Translator**, a machine language program (to be used with **The Voice** hardware speech synthesizer) that uses a sophisticated algorithm and exception table to automatically convert text to speech. **The Translator** will even allow you to type words in one language and have **The Voice** speak in another. Includes *Reaction*, which tests your reflexes as **The Voice** gives you commands; and *Simon*, which tests your memory for numbers spoken by **The Voice**. Speech Systems, 38W255 Deerpath Rd., Batavia, IL 60510, cassette or disk (including above described programs) \$29.95

**TRS-80 Program And Applications For The Color Computer**, by Al Baker, a handy 187-page guide for personal computing applications. Using this book, you can learn to play games on your TRS-80 CoCo, balance your checkbook, or keep track of important

household and business information. This book is also designed to sharpen the programming skills of the experienced user. Reston Publishing Company, Inc., 11480 Sunset Hills Rd., Reston, VA 22090, \$14.95

**Vector Addition**, (part of the Computer Assisted Instruction series) is an educational courseware package that allows secondary students to study vector concepts on the microcomputer. The program was written in an effort to help students master the concepts without overemphasizing the mathematics involved. It assumes that students have been introduced to vectors, including addition by the tip-to-tail method and addition by the parallelogram method. Topics include: fundamentals of vectors; displacement; velocity and acceleration; force; gravitation; conservation of momentum; and electric forces and fields. Radio Shack stores nationwide, cat. number 26-2638, 16K tape \$39.95

**VIP Database** (formerly Super "Color" Database), a 32K disk, high speed ML program which fills all your information management needs, be they for your business or home. Features include: machine code, lowercase screens, mail merge capabilities, inventory, accounts, mailing lists, family histories, etc. It also sorts and merges with *VIP Writer* files. Your data is stored in records of your own design, each divided into up to 255 fields. Each field holds up to 255 characters. All files are fully indexed for speed and efficiency. Full sort of records is provided for easy listing of names, figures, addresses, etc., in ascending or descending alphabetic or numeric order. You may also combine files, sort and print mailing lists, print "boiler plate" documents, etc. The math package even performs arithmetic operations and updates other fields. It also features the Mini Disk Operating System. Softlaw Corp., 9072 Lyndale Avenue South, Minneapolis, MN 55420, disk \$59.95

**The Voice**, a hardware speech synthesizer that plugs into the Color Computer's cartridge slot. It uses the sophisticated SC-01 by VOTRAX to reproduce any word. Speech may be heard through the TV speaker or the built-in audio power amplifier with volume control may be connected to your own external speaker. It comes assembled with all the necessary hardware. Runs in 16K, 32K or 64K computers. It includes *Math Tutor* — **The Voice** tutors your child in arithmetic; *Bingo* — **The Voice** announces the bingo tiles while you play; *High Low* — **The Voice** gives you hints in guessing a number it has picked; and *Editor* — This will help you develop words phonetically. Speech Systems, 38W255 Deerpath Rd., Batavia, IL 60510, hardware and programs above — cassette or disk \$79.95. 40-page manual for evaluation \$4

The *Seal of Certification* program is open to all manufacturers of products for the TRS-80 Color Computer, the TDP-100, or the Dragon-32, regardless of whether they advertise in *the Rainbow*. By awarding a *Seal*, the magazine certifies the program *does exist*, but this *does not* constitute any guarantee of satisfaction. As soon as possible, these hardware or software items will be forwarded to *the Rainbow's* reviewers for evaluation.

—Susan Remini

# REVIEWS

## TALKING SPELLER

Editor:

I must reply to H. A. Manning's response (November, p. 237) to my review of "Talking Speller" (September, p. 199).

Marshall McLuhan warned that we must avoid approaching new media and technologies "through a rear view mirror," pouring the obsolete content of the old into the new, ignoring the potential of the new for original ideas and messages. The "rear view mirror" phenomenon is taking place in a great many educational programs written for the Color Computer.

Research in the learning of spelling shows that even youngest children, drill in words taken out of context does not produce language mastery with much efficiency. This is not a matter of "philosophizing," as Manning phrases it, but of *fact*. A computer program that merely replaces a teacher but still teaches rote mastery of spellings is, therefore, suspect on very real pedagogical grounds. I believe it is the duty of the reviewer to point out pedagogical weaknesses in educational programs written for the Color Computer. It is not enough merely to plug in the program and to attest that it runs smoothly. A badly conceived program must be identified as such, even if it runs to perfection.

As an educator, I am concerned first with the quality and secondarily with seeing home computers can move education forward. As a reviewer — for *Rainbow* or any other magazine — I will continue to point out misuses of computer technology when I perceive them.

Stephen N. Tchudi  
Okemos, MI

## BIO DETECTOR

Editor:

I would like to respond to *Rainbow's* review of Computerware's *Bio Detector*. First, it is not a game! The *Bio Detector's* primary purpose is for biofeedback using galvanic skin response. We have several institutional customers using their CoCo and *Bio Detectors* in special biofeedback programs. A game program called *Anxiety Attack* is included for fun and reportedly has been a big hit at many parties.

Secondly, the *Bio Detector* does work! The most common comment we have received from customers is how sensitive it is! Of the many hundreds of *Bio Detectors* sold, we have not received a single one returned. I

am disappointed to see that a reviewer with the responsibility of thoroughly investigating a product for your readers would not even contact the manufacturer concerning the attitude of this reviewer and rely on the reputation for quality that the Computerware label represents.

Sue Searby  
Computerware

## LOWRCASE

Editor:

Here is a review of Ed Lowe's review of the *Lowrcase* descenders program for the Radio Shack DMP 100 printer (from KRT Software). He obviously expected some criticism, having so stated in his review. Here it is: If a review on any product is to be published, there is a responsibility to readers to be objective and thorough.

If the reviewer had tried *Lowrcase* with Telewriter 64 he might have been quite pleased with the results. The DMP 100, *Lowrcase*, and Telewriter 64 are used in my business (writing and formatting resumes). When my typesetter complained about the lack of descenders on resume draft layouts, I ordered the *Lowrcase* from KRT. Frankly, the first two tapes failed — but KRT not only stood behind its product, they sent me the flight simulator program to compensate for my troubles — and, by the way, that program is fantastic!

The descenders program works extremely well and, contrary to popular belief, does work at the 1200 Baud rate. There is not an objectionable printing slow-down (as compared to printing time without the descenders program). Finally, the results are infinitely better than *not* having descenders print. I am no longer ashamed to use the DMP 100 for correspondence purposes!

Is the descenders program worth it? Lowe says not. I say, from the perspective of a businessman, it most assuredly is; \$15.95 is considerably less expensive than buying another printer with built-in descenders! Shame on you for printing an incomplete review. I trust future reviewers will be more thorough in trying and reviewing products.

C.J. (Bucky) Helmer, Jr.  
Binghamton, NY

Editor:

I would like to comment on a review made by Ed Lowe in the December 1983 issue about KRT Software's *Lowrcase Descenders* program. I had purchased that program myself for my LP-VII (now sold) and was

very pleased with it, although it was rather expensive. What exactly did he expect for \$15.95, a hardware mod? It, by the way, does not double space but rather gives a sort of 1½ spacing which I find better than the original. The program thus gives 49 lines per page instead of 66. I agree it was slow, but what did he want?

Paul Gani  
Marshfield, WI

Editor

Boo, hiss, on Mr. Ed Lowe's review of the *Lowrcase* program. The review is located on Page 262 of the December, 1983 *Rainbow*.

I have been using the package almost daily since it was sent to me July 22, 1983. I am very pleased with the results. I use it in conjunction with a *Telewriter-64* program for output on a DMP-100 printer. As stated by Mr. Lowe, "it was the most I could afford..." The *Lowrcase* program has allowed my DMP-100 to move into the word processing world "of the 'bigger' dot-matrix printers with true descenders," as a result of the new character set style afforded by this program.

At the church, I use the system weekly to send out letters to visitors and I also use it to support various organizations in the church with "form letters." There have been no complaints! To date that includes both the editor and my son's test grades.

Granted, what Mr. Lowe indicates about throughput is indeed true. It does require almost twice the time to print a line, since two passes are required. The vertical spacing is not quite double, however. My 11-inch form under *Telewriter-64* now has 49 lines instead of 66. In addition, there is a little more vertical spacing on my program printouts which really improves their readability.

Not only do I feel the package is well worth the \$15.95 price, compared to the cost of real descenders on a matrix printer, but I have *never, never* had it cause any system problems, nor produce unexpected results. That's high reliability.

Now that I've said the above I feel that I must editorialize just a bit. Mr. Lowe's review and my rebuttal simply illustrate a very salient point in the software world: the ability of a software offering to perform the task which the purchaser wishes to perform, at a price he wishes to pay to have the job done. Those who achieve the desired results are happy. Those who feel the offering does not meet their expectations are unhappy. The key word here is the word "expectations." Unclear advertising, half-truths, and sales "hype" all contribute to establishing the expectations for a software offering.

Sometimes the expectation is extremely false. The real caveat becomes "try it, you'll like it" . . . or maybe you won't! But you'll probably have to try it to be sure.

One other quick note. On two occasions I have had the privilege to discuss program problems with the proprietor of KRT Software, Mr. Ken Elder. The first occasion was a result of changes made in *Telewriter-64*. The second was concerning his program and a spooling application. This brings up the subject of "support" after purchase. Let me just say that, in both conversations with Mr. Elder, I found him to be honestly interested in my problem and eager to assist me in developing a solution. With individuals such as him writing and selling (and *servicing*) software the marketplace will *never* be "caveat emptor."

Keep up the fine magazine. It's the best CoCo magazine on the shelf! Please include more OS-9 information for those of us who have purchased this fine operating system from Radio Shack.

Bob Hawkins  
Brushy Creek Baptist Church  
Round Rock, TX

**Editor:**

While I hold no special interest in KRT Software, or in the *Lowcase* program, the review was somewhat disturbing to me.

The reviewer made a statement that he did not even try the program with the Cognitec *Telewriter-64* text processing program. To anyone who has used the *Lowcase* program, it is obvious that *Lowcase* was written principally for that purpose. Thus, the reviewer in his lackadaisical approach seems to have completely missed the major point.

What disturbs me is this: is this the normal method used in reviewing products for your magazine? Is it usual for a reviewer to do only part of the job of testing a product? If so, then you are doing a poor service for your readers. Better no review at all than a job only partly done.

My immediate reaction to this particular review is that I am now somewhat distrustful of all the product reviews which you print.

R. K. Landrum  
Birmingham, AL

**Editor:**

I just finished reading the December review of KRT Software's program *Lowcase*, and was immediately prompted to write you. Having recently received my copy of *Lowcase*, I could not believe what my eyes were reading in *the Rainbow*.

At least the reviewer was honest enough to admit that he never used the program with *Telewriter-64*. I am bothered, however, by someone who would pan the work of another in a major publication without doing his

homework, and then have the nerve to admit it. Not only am I pleased with the KRT product, as you can tell from the print obtained with my DMP-100, but I would also like to add a word of praise for the people at KRT as represented by Mr. Ken Elder. I have found Mr. Elder to be a very helpful and concerned individual who will cheerfully spend time with his customers to assist them in their use of a software product new to them.

As always, three cheers for *the Rainbow*, the magazine for the Color Computer.

Ted Gundersen  
Valhalla, NY

---

### CC-DBM/LW

**Editor:**

The December issue of *Rainbow* carried a review of *CC-DBM/LW* on Page 268 by Gerry Schechter. I read this review as part of reading your great magazine from cover to cover as I always do.

Based on the review and my need for an easy way to crank out a short letter to one person or a group, I decided to purchase this software from EVS Engineering.

In the EVS Engineering ad on Page 9 it says "Personal checks — OK we won't make you wait." Let me tell you what that means. On November 21 I sent EVS a discount coupon and a personal check for \$31.95 (includes \$2 for shipping and handling). The EVS invoice indicates they processed the order on November 23, and sent the software to me on the same day priority mail at a cost of \$2.58. I had the software on November 26. Who can ask for more than that for service?

Now, about this EVS software that I purchased. Gerry Schechter's review is very accurate. "If you are in the market for a full-blown database or word processing system, then you should look elsewhere." I know this to be true because, based on another *Rainbow* review, I purchased *Telewriter-64* some time ago. Now, *CC-DBM/LW* is not *Telewriter-64*, but, it is just as great in its own way.

To sum it all up, good review, good software, good value and as usual, good *Rainbow*. By the way, this letter was done using EVS Engineering's *CC-DBM/LW* software.

Joseph G. Hardy  
Rockville, MD

---

### SONAR SEARCH

**Editor:**

I am an author for Shell Software, and I wrote the program *Sonar Search* which was

reviewed in the November 1983 issue of your magazine. I was pretty satisfied with the review except for one thing. The reviewer stated that he got a very negative reaction to the price of \$18.95 for a program written in BASIC. In my opinion, that is simply absurd! First of all, would rewriting the game in machine language justify the price? Remember, as stated in the review, *Sonar Search* is not a high speed shoot-em-up, and it wasn't meant to be, therefore machine language wasn't needed. Secondly, \$18.95 is *not* a high price to pay for a game since many games cost \$25 to \$35. I can see charging a *little* more for a machine language game over a BASIC game, since a machine language game usually takes longer to write, but not as much more as is implied in the review. Otherwise, I feel it's like paying an employee more or less than another employee on the basis of race or sex. As long as the employee does a good job, who cares about the race or sex of the employee? Likewise, as long as the game is good, who cares about the language the game is written in? In fact, when I see a game advertised for a very low price, I begin to wonder *why* it costs so little.

The reviewer seemed to think that the packaging was the culprit for the "high" price. Well, let me tell you that after the price of the cassettes, printing of the instructions, artwork, and all of the time that goes into writing the program are considered, the price of the packaging has very little effect on the price of the game. In fact, all games from Shell Software are packaged like *Sonar Search* because we got a low price on a large quantity of the packages.

Since I am on the subject of reviews, let me tell you about an idea that I have for reviewing programs. You see, your magazine is the largest magazine dedicated to the CoCo. Therefore, the opinion of one reviewer on your staff will probably determine, to a large extent, whether the program reviewed will sell or not. I do not consider this a fair system because opinions can vary greatly from one person to another. An example of this goes back to the packaging of our programs. The reviewer of *Sonar Search* didn't seem to like our packaging much, but the reviewer of *Death Star* (also by Shell Software, reviewed in the April 1983 issue of *the Rainbow*) was impressed with it. This is actually a trivial matter since it has nothing to do with the game itself, but it illustrates a difference of opinion. Since opinions can vary so much, I feel that two people should review each program, possibly with opposing views so each reviewer could point out what they did or did not like about the program. Otherwise, I feel you have a great magazine.

Bob Schmerling  
Winter Springs, FL

# Valhalla — A Very Good War Game For The CoCo

By Tom Roginski

I have played all types of war games starting with the old board game "Gettysburg" and continuing to the modern computer war games of the present. The Apple and the Atari have had true war games for some time; the CoCo only recently. *Valhalla* is a fine recent entry which does qualify as a true war game. It also has the addition of some fine graphics. As with all such games, the rules are not simple. I will present the basic flavor of the game without giving complete details.

*Valhalla* is a board game played between two teams with the computer acting as the scorekeeper, map maker, and judge. This approach makes for a much faster game than similar games do without the computer. More moves can be made in a given period of time and no time is lost with disputes between players. Each team consists of one or two players who are in command of various armies and officers. Each team starts with two lords, two generals, four captains,

and eight armies consisting of five swordsmen, five archers, five light cavalry, and five heavy cavalry units each.

While each team starts out even, the way the forces are used determines the final outcome of the war. These forces must be moved around the field where various castles, villages, mountains, marches, rivers, and river fords are placed. Castles must be used for defense and to gain replacements for forces lost in battle. Villages must be used for supplies. You start out with five turns of supplies and must pass through a village to obtain more supplies or you will suffer a loss of men. The only way to make an aggressive attack into enemy territory is to either stock up on supplies or to capture an enemy city.

The strength of each type of unit in combat is determined by the unit's basic strength modified by several factors. The strongest basic unit is the heavy cavalry and the weakest are the swordsmen and archers. Basic fighting factors of the units are modified depending on terrain. Heavy cavalry has its basic strength increased in the open or on a road while it is decreased in a ford or other bad ground. In the rough, light cavalry is actually better than heavy. The designers of this game have done a good job researching the tactics of land warfare. By careful use of the terrain, a weaker unit can defeat an otherwise more powerful one.

There are two basic types of graphic screens used in this game. The usual screen is the map. This screen is an excellent, Hi-Res picture of the battlefield. On this screen the terrain, villages, and castles are shown. Included with this game are two different map setups or scenarios. More scenarios are promised in the instruction sheet. Scenario One is rather even with the two sides of the board almost, but not quite, mirror images. Most of the play between evenly matched players might be made in this scenario.

Scenario Two has the two sides of the board rather different. The blue side (which moves first) has a terrain greatly cluttered with rough ground, marshes, and other movement problems. This works to the disadvantage of the blue player giving him or her problems in moving. One portion of the force located behind the lake is especially difficult to move into action. The terrain also works to some advantage of the blue player by making it difficult for the red player to get around the board to attack. If the players are greatly different in playing ability, giving the weaker the red side in this scenario will give him a chance to get used to the game and to set up a defense.

The other type of screen used in this game will lead me to describe what is probably the game's only flaw. A battle begins after any movement phase in which two opposing armies are moved in contact with each other. The two sides are then represented as four Hi-Res symbols for each of the four types of military forces (swordsmen, light cavalry, heavy cavalry, and archers). A number is then placed along the symbol to indicate the number of this force remaining in the army. The attacking player and then the defender each place six units on the front line. The officer of each side is then placed. At this time, the computer puts these symbols in the proper position and starts the generation of random numbers.

Each unit is played against the unit in front of it. After each unit is played the loser is removed from the board and the players are asked if they want to retreat. If a side wishes to retreat, it may do so automatically and without additional losses. It may be only my opinion, but I do not agree that no retreating forces should be lost. Because of the lack of

## WANTED!

Young men and women seeking adventure, excitement and thrill-a-minute action. No experience necessary—just you and your Color Computer. See below:

### FOR THE 32K THRILLSEEKER

ZAXXON, Disk or Cass.	DataSoft	\$29.95
PROTECTOR II, Cass.	Synapse	\$29.95
DESERT PATROL, Cass.	Arcade Anim.	\$21.95
ICEMASTER, Cass.	Arcade Anim.	\$21.95
FOODWAR, Cass.	Arcade Anim.	\$22.95
WACKY FOOD, Cass.	Arcade Anim.	\$19.95
CASHMAN, Cass.	Comp. Shack	\$24.95
CHOPPER STRIKE, Cass.	Comp. Shack	\$24.95

### LOTS OF PLAY FOR 16K

MOONSHUTTLE, Cass.	DataSoft	\$26.95
SHAMUS, Cass.	Synapse	\$29.95
FROG TREK, Cass.	Oelrich	\$14.95
3-D TIC-TAC-TOE, Cass.	Oelrich	\$16.95

Interested applicants send check or m/o to:

**OELRICH PUBLICATIONS**  
**4040 N. NASHVILLE**  
**CHICAGO, IL 60634**

Credit card orders, call: 800-621-0105

(In Illinois: 312-545-9286)

communication in medieval and ancient warfare, major losses can occur during a retreat.

It is when more than two opposing armies are in contact that the game shows its only flaw. The battle board only has the ability to show one army against another and each unit against only the unit placed in front of it. When the attacker or the defender have more than one army, the other force is not used in the first battle. All battles are one army against another. The additional force must fight after one of the first two armies have been eliminated or retreats. If one player has only two units left and cannot retreat, his two units do not have to fight more than the two units directly in front of them. In the history of war, the principle of bringing all possible force to bear against a single point is of prime importance. This principle must be employed here by using the terrain factors to advantage. A force cannot retreat with a river or lake behind it. You can attack with one unit until it is reduced to a certain level, retreat it, and then attack with the second unit.

One additional refinement should be mentioned. If an army is in a castle, it has the choice of coming out of the castle to attack or to stay in and accept a siege. If the defender stays in the castle, the attacker can try to ram to force a battle. If the ram fails, both sides lose a small number of units and the attack stops. During the siege, the force in the castle is not reinforced or resupplied. This siege feature is a nice refinement.

A point system is used for the determination of the victor. Each player starts with 200 points and then gets more points for the destruction of enemy units and loses points for the loss of officers, castles, and villages. At the beginning of the game the players decide how many turns the game will have. A short game usually would result in an attempt to destroy as much of the opposing force as possible while a longer game will include the consideration of supplies and reinforcement.

Incomplete games can be saved to tape. This is done by pushing the right joystick button instead of the left joystick button when the scorecard is shown. Use caution when the score shows because if you push the wrong button (which I did several times) the computer will attempt to save instead of going to the next turn. I have found that if the game stops after an accidental attempt to save, it is usually possible to get back to the game without any changes by typing: *GOTO3* [ENTER]. This might be interesting if you wish to try two different ways of completing a game from a specific position.

The instruction sheet that comes with the game is adequate. It gives a good, clear description of the game and the rules. Its appearance is not the best, being a copy of a Line Printer VII printout.

This is a very good game. Although the way the battles are decided between unequal forces is not as I would like, this is one of the best war games that is available for the Color Computer. It is also one that would be considered a very good war game and graphic display for any computer. The minor exceptions that I have taken with the game are probably partly due to the length of the game. There is no room for the disk system. With the disk removed, I typed *PRINT MEM* and found only 285 bytes left on my 32K CoCo!

(HYCOMP Software, P.O. Box 15331, Tulsa, OK 74158.  
\$24.95 in 32K tape version.)



## PAL CREATIONS

Specializing in 32K ECB Text Adventures  
And Simulations On Cassette

- \* **SAC** For those against nuclear disarmament — pilot a B52 to any one of the 36 Soviet cities, destroy it with a nuclear bomb, and make it back to the base. 9 difficulty levels. You can use keyboard or joystick or both. This simulation takes a lot of pre-planning and fast thinking. \$19.95
- \* **HERE COME DE PREZ** Are you fed up with the State of the Union? If so, run for president in this 1 or 2 player simulation complete with scandals, national disasters, and debates. \$14.95
- \* **PRIVATE INVESTIGATOR** Murder! Could Sherlock Holmes have solved this whodunit adventure simulation? \$14.95
- ISLE OF FORTUNE** You are a fisherman in a waterfront bar. The old salt just told you a tale of treasure on an island, before the poison dart struck. Sail your ship to dangerous adventure awaiting you on the Isle of Fortune. \$19.95
- SCAVANGE HUNT** Find the items on the list and return them to Hickory Ridge to free your niece Rebecca from the hermit of Medicine Tree County. \$15.95
- \* **BOMB SCARE** A terrorist group has planted 8 bombs in a city. Your mission: locate and disarm all 8 before time runs out. 1 is The Big One. \$14.95
- \* **DARK CASTLE** Monsters-magic-myths. King Lothar of Rom has been abducted by the evil wizard. Destroy the wizard and return Lothar to his throne. \$14.95
- MANSION OF DOOM** Destroy the Vampire, rescue Princess Marlena. \$14.95
- \* **WITCHES KNIGHT** Back to the days of old, where knights were bold and magic ruled the land. Many enchanted surprises await you on your quest to free Sir Noble from the witches evil spell. \$15.95
- BEACON** Can you signal the ship before it runs aground? \$14.95
- \* **SPACE ESCAPE** Explore a death-ridden alien spacecraft in search of a way back to Earth. \$14.95
- STALAG** Escape the German prison camp before its bombed. \$14.95
- \* **EVASION** Sequel to STALAG! Get out of Germany alive. \$19.95
- \* **FUNHOUSE** Work your way through this unique Funhouse searching for the way out. \$14.95
- \* **SCATTERBRAIN** Help wanted: Put Commodore Winslow's 85-room mansion in order in this graphic adventure. \$14.95

Buy any 1 of the programs above and get  
any of the bonus programs below FREE!

- \* **SKI LODGE** Times are tough, weather is bad. Manage a Vermont ski lodge successfully to win this 1-4 player simulation.
- MOTHER LODE** You just inherited your great-grandfather's goldmine. Did he die penniless?
- ENO** You inherited a million dollars. Just one catch — first you have to find it!
- BETTER** A better betting game for 1-4 players. You choose the winning criteria.
- MATCH-IT** A challenging word game in which you identify your opponent's 5-letter word using deduction. 1-4 players.

### \* DIFFERENT EVERY TIME

Send check or money order to:

**PAL CREATIONS**

10456 Amantha Ave., San Diego, CA 92126

Calif. residents add 6% sales tax.

## Dyterm Is A Good Program With Tough Documentation

The material says you can convert your CoCo into a "smart terminal" inexpensively using *Dyterm*. While that is so, they ought also to have another program to create a "smart terminal operator."

*Dyterm* works, it is user modifiable, you don't have to have Extended BASIC, and it does most of what it says it will, but you have to be sharp to find out how and why. If you know nothing about terminal programs, the documentation for *Dyterm* may leave you that way. The four-page document often opens interesting questions, but does not give what I call adequate directions.

As an instance, the neophyte may not quite understand the designation of a data block as outlined in the documentation. It would take only a few more words to clear up this matter. An attempt is made on Page 4 of the document, but I think it needs to be more specific.

There is a need to prepare cables if you are using the program between terminals. There is a description of these in the documentation, but nary a hint if you can purchase a ready-made cable or how to go about making one. I am saying it is a good idea to be more specific about terminals and terminal programs.

### FILEBOX/16 HOME FILING SYSTEM

**RID YOURSELF OF THOSE NUMEROUS PAPER FILES AROUND THE HOUSE. ENTER THE INFORMATION AGE WITH FILEBOX/16, THE HOME FILING SYSTEM FOR THE 16K COLOR COMPUTER.**

Create, change, update, delete, search, sort and list files you define. You don't have to be a programmer to use this system. For the TRS-80 Color Computer with 16K Extended BASIC and one disk drive.

Applications are virtually unlimited. Use for address lists, car repair records, household inventories, book and record collections, tax records, etc. You can use **FILEBOX/16** to print mailing labels. This use alone is worth your purchase price.

Each file you create can contain any number of records. Each record can contain up to 10 fields and 256 characters. Print records to screen or printer.

**FILEBOX/16 IS EASY TO USE.** This is NOT a system which requires that you learn special keys and operations. It is completely menu-driven. Has built-in lessons to supplement the 20 page loose-leaf User Guide.

**FILEBOX/16** is written in BASIC with a machine language sort. It uses efficient formatted direct access file logic contained in 8 programs you control from a menu.

**SPECIAL PRICE—Now only \$29.90**

was \$39.90

Plus \$2.00 shipping

New Jersey residents please add \$1.80 for sales tax.

Mail check or money order to  
CIRCLING STAR SOFTWARE CO  
P.O. Box 1218  
Freehold, NJ 07728  
Phone: (201) 431-3660 after 6 p.m.



**FILEBOX/16** © 1983 by Luke Watson  
TRS-80 is a trademark of the Tandy Corp.

I think sometimes software authors just automatically think everybody knows everything about computers. It would be nice if they were right, but more and more people are button pushers, and you have to think of them.

None of this will detract from the fact the program does convert your CoCo into a terminal and will change Baud rates (300 to 2400) and stop bits and all the goodies.

It loaded right up from the tape and ran like a bandit in the tape mode. After *PCLEAR2ing*, the tape was excellent quality with no problems. Just to make sure, I loaded a version onto disk using the tape to disk program from Tom Mix, which has been my good right arm.

Since *Dyterm* is a BASIC program with machine language routines generated by BASIC, there is no problem of a start, end or transfer address. It loaded to disk just fine and runs like a bandito. (That is, quicker than tape!) The program will drive my Radio Shack Modem II, and I was able to raise Bob Rosen's B.B.S.

You have to toggle between send and receive by hitting the [SHIFT] and the down arrow. I got that all mixed up and only got as far as where Bob asked me my first name before I blew the transmission out the window. It was my fault, but I am like many other first users.

When I was cranking the program up, I called Bill Chaple of Dynamic Electronics to discuss the program and ask what he thought it was all about. He is a personable guy and ready to answer your questions and learn from what you have to say.

The text entering capability and preloading are a real plus on this program. There is no provision for storing the text from the buffer, but you should be able to remedy that matter since the program is in BASIC and you could fit the routine in if you wish.

There are many merits to this program, not the least of which is low cost. I have a couple of terminal programs which are easier to run, but then again, I laid out quite a few more beans to purchase them.

*Dyterm* also comes in cartridge form, which I did not operate. The tape/disk version is \$14.95 and the cartridge sells for \$24.95.

A serious programmer who knows what is happening will like this program. Someone new to the computer world might need some help.

(Dynamic Electronics Inc., P.O. Box 896, Hartselle, AL 35640, \$14.95 tape, \$24.95 cartridge)

—Howard Lee Ball

### SPEED UP YOUR PROGRAMS NOW!

-Now everyone can create fast, efficient Machine Language programs without learning Assembly language programming. That's right, with this new **BASIC COMPILER**, called **INTBASIC**, one can convert BASIC programs to Machine Language.

-**INTBASIC** is a machine language program featuring most BASIC command words. It is compatible with Color, Extended Color and Disk BASIC systems. It loads from tape or disk and is EXECuted "In Memory" (**NO DISK NEEDED**).

-**INTBASIC** allows m.l. programs to use ALL 64K OF RAM. Versions for 16,32 and 64K systems are **ALL INCLUDED FOR THE SAME PRICE**. Color Computer II versions are also now available (Please indicate model #).

Send check or money order. No C.O.D. Utah residents add 5% tax.

**WASATCHWARE**  
7350 Nutree Drive  
Salt Lake City, Utah  
84121  
Call (801) 943-6263

Tape- \$39.95



-Send for our current list of other software available.



## Ice Master: A Refreshing Change Of Pace

*Ice Master*, by Arcade Animations, Inc., is a simple but colorful game with good graphics and sound. In *Ice Master*, the player does not assume any fantasy role identity such as commander of an inter-galactic spaceship. It's you against an assortment of computer-generated menaces in a fast-moving battle to destroy or be destroyed. Your only enemies are mosquitoes and your only weapons are blocks of ice.

You begin the game surrounded by a number of mosquitoes, depending on the level of difficulty you choose. These disease carrying insects swarm the screen, melting your only defense device—the blocks of ice, while they seek to extract your blood to destroy you. You are a little man in the opening screen, hiding in a center safety box, patiently waiting for a clear way out. There are approximately 50 randomly arranged blocks of ice surrounding you. Your only objective: To survive by sliding the blocks of ice into the mosquitoes and avoid getting stung.

The object of the game sounds simple. However, the mosquitoes move at an extremely quick pace. You control movement of your man with the right joystick and move the blocks of ice by pressing the fire button which pushes the

blocks into the mosquitoes. There is also a bonus timer at the top of the screen. The timer starts at 7,500 points and decreases in increments of about 100 points per second. Therefore, you have approximately 75 seconds to crush all of the mosquitoes on the screen to obtain any bonus points.

Points are obtained by either crushing a mosquito (100 points) or by melting blocks of ice (25 points). Blocks of ice can only slide one at a time and will melt if pushed when another block of ice is adjoining. The faster you destroy all of the mosquitoes on the screen, the higher your bonus score. After completing a screen, you simply start the screen over, with the only difference being a different arrangement of blocks of ice.

*Ice Master* is a deceiving game whose concept is so original that it defies classification. There aren't many different enemies attacking, but the mosquitoes are fast and very smart. The blocks of ice are your only defensive weapon in the game in addition to your craftiness of forming the blocks of ice.

I found *Ice Master* to be a refreshing change of pace from the run-of-the-mill shoot-'em-ups. Forget about spaceships, laser beams, and firing rockets. Just watch out for those nameless mosquitoes that flit, skitter and swoop around on your CoCo screen. Its originality and fast-paced action were the first things to capture my attention.

(Arcade Animations, Inc., 21 The Fairway, Upper Montclair, NJ 07043, 32K disk, \$26.95, 32K cassette, \$24.95)

—Jutta Kapfhammer

**NEW!**

## For Your TRS-80 Color Computer 128 Full-time Audio Talk/Tutor Programs!



### We're Your Educational Software Source

#### LANGUAGE ARTS

- Spelling (16 programs)
- Level 3-4 (16 programs)  
(words in context with definitions and synonyms)
- Phonics (16 programs)
- English as a Second Language (32 programs)

#### MATHEMATICS

- Levels 1-6 Numbers (16 programs)
- Basic Algebra (16 programs)

#### SCIENCE & TECHNOLOGY

- Physics (16 programs)

### In Color, with Pictures and Text!

All of our TRS-80 Color programs have easy to understand professional announcer narration, not synthesized, robotic voices. All text is displayed in easy to read upper- and lower-case characters. Video clearly illustrates key concepts in each frame of the program.

Only \$4.40 per program. (\$8.80 for 2, one on each side of a half-hour cassette). \$59.00 for 16 programs (8 cassettes) in an album. Send for a catalog of over 1000 programs for Atari, TRS-80, Apple, etc.

For more information, or to order call:

**TOLL FREE 1-800-654-3871**



**DORSETT**

**Educational Systems, Inc.**  
Box 1226, Norman, OK 73070

# Double Density Software

## COLOR TERM + PLUS +

If you're looking for the finest terminal software you can buy, look no further! And now we've added a **high-res screen** display that gives you 32 by 16, 42, 51, or 64 by 24 lines.\* And you can switch between the high-res screen and the normal screen *without* destroying what you have in the buffer! + **PLUS** + we have a buffer editor, complete up and down load support, on-line cassette or disk reads and writes, off-line and on-line scrolling, pre-entry of data *before* calling, word wrap, buffer printing, selective printing, change any parameter so you can communicate with **any** other computer. You can send and receive Basic programs, ASCII file, as well as machine code, + **PLUS** + you can save your buffer to tape (Tape or Rom version) or disk (Disk version). You can communicate with the local **BBS**, **Compuserve™**, **The Source™**, the main frame at work or school, other color computers, Apples, IBM PC's, TRS-80 Model I, II, III, IV, 12, 16, 100, or any other computer via RS-232.

Compare these features with **any** other terminal program:



32 x 16, 42, 51, 64 x 24 Screen  
Communications BAUD Rate: 110-19200  
Printer Baud Rate: 600-9600  
Select Half or Full Duplex.  
Select Odd, Even, or No Parity.  
Select 7 or 8 Bit Words.  
Send Control Characters.  
Send a True Line Break.  
Separate Keys for Escape and Rubout.  
Select All Caps If Needed.  
Word Wrap — Eliminate Split Words.  
(32 Character Mode)  
Selectable Reverse or Normal Video.  
(32 Character Mode)



Scroll Protect Up to 9 Lines.  
Automatic Capture of Incoming Files, Send One Line At a Time From Your Buffer.  
Has Programmable Prompt for "Send Next Line!!"  
Buffer Size Indicator.  
Complete Up and Down Load Support.  
Improved Buffer Editor.  
On/Off Line Scrolling of Buffer.  
On/Off Cassette or Disk Reads and Writes.  
Pre-Enter Data Before Going On-Line.  
Save/Load Machine Code, Basic Programs or Files.  
Select Printer Line Feeds If Needed or Ignore All Line Feeds in Buffer.

\*Disk and Rom Pack only (not on tape). PRICE: \$29.95 (TAPE) \$39.95 (ROM PACK) \$39.95 (DISK)

## COLOR KEY COMMAND

COLOR KEY COMMAND is a BASIC programming aid that will speed the entry of your programs. You can increase your programming speed by as much as 50%. Instead of having to type in all of the BASIC commands, you can simply press a control key, and then press one other key — the BASIC word is entered for you automatically! You can also activate the automatic line numbering mode, then every time you press enter a new line number is entered for you. You can select the start line and the increment. Ever wanted to copy lines you have already entered? Now you can. Simply type in the line number you want to copy, then type in the new line number. The new line is immediately displayed and you are put in Extended Basic's EDIT Mode. Either edit the line, or press ENTER. (This command is not available to those with non-extended Basic users.) How about merging programs together from tape? Those with Extended Basic do not even have to worry about proper line numbering, COLOR KEY COMMAND will RENUMBER each program as it is loaded into memory! COLOR KEY COMMAND also has four custom programmable keys! Each key is capable of holding 64 characters each! How would you like one button entry of 64 characters? What else will COLOR KEY COMMAND do? One button RUN, CLOAD, CLOADM, LLIST, LIST, RENUM, MOTORON, MOTOROFF, AUDIOON, AUDIOOFF, TRON, TROFF. Those with disk systems get one button BACKUP, DIR, FREE, and also you can print your directory to the printer with the touch of a button! You can turn off the program any time by pressing the CCMD OFF button. How can we offer so much for so little? We made templates that you can cut out yourself. You do about an hours work or less and save

about \$8.00. That is how much more we would have to charge if we did the work. You save in the process! You can also reprogram the prompt, no more "OK," and select the cursor color you want.  
16K or 32K Required PRICE: \$18.95 (Tape)

## DOUBLE DOS BASIC



364,000 BYTES!

That's right! Using your 64K Color Computer, and an 80 track drive, you too can have more than **TWICE** as much storage on your disk drive system. **DOUBLE DOS BASIC** allows you to use 35, 40 or 80 track (double or single sided) drives all on one system, all at the same time! Your system could consist of a 35 track drive, a two drive AMDEK system, and an 80 track drive, all working, and hooked up to your system! (The AMDEK drives are 40 track drives.) **ALL** commands are supported in **DOUBLE DOS BASIC**. The DOS is **totally** transparent to your BASIC programs! If your system selection is 80 tracks, a PRINT FREE command will return 158 granules! Compare this to the 68 granules your system now returns! The 40 track drives would return 78 granules, 10 more than the 35 track system. **EVERY** command in BASIC is supported by **DOUBLE DOS BASIC**. If you haven't already upgraded to 64K, now is the time! Use your system to its **FULLEST!** **DOUBLE DOS BASIC** also gives you RESET PROTECTION, unlike most of the other 64K programs. **AND**, used with our ROM MOVE program, you can also get another 8000 bytes of BASIC addressable memory!  
DOUBLE DOS BASIC — \$24.95  
DOUBLE DOS & ROM MOVE — \$29.95

# Double Density Software

## DOUBLE MAILER

At last a **powerful**, easy to use, mailing list program for a *reasonable* price. Up to **200 names** can be held in memory for you to change or print as you like. Plus, you can print out up to **1800 names** without touching the keyboard. The machine language sort routine will sort 200 names in as little as **6 seconds!** Supports single or double labels. Three and four line labels can be intermixed at will, the print out will adjust accordingly. All this and much more!

32K Required  
PRICE: Tape \$19.95 Disk \$21.95

## ROM MOVE

Are you tired of having only 32K of memory when you have a 64K computer? ROM MOVE is just what you need! With ROM MOVE, you are given another 8000 bytes of room for your BASIC or Machine Language programs! You can switch from BASIC to EXTENDED BASIC to DISK BASIC easily.

Ask about our 48K version; 64K Required  
PRICE: \$12.95 (Tape)

## ROM SWITCH

Change from BASIC to EXTENDED BASIC, to DISK BASIC and back again with ROM SWITCH! You can even press the RESET button, and with one POKE, restore the system!

64K Required (Tape)  
PRICE: \$9.95

## COLOR BIORHYTHM

Are you up or down today, yesterday, tomorrow or years from now? Find out with COLOR BIORHYTHM! Plot your biorhythm to the screen with high res color graphics, and use the printer to make a chart. 29 days can be displayed each time.

16K or 32K Extended Basic Required  
PRICE: \$14.95 (Tape)

## UNDERGROUND

Tired of adventure games with limited descriptions of your surroundings? UNDERGROUND describes your surroundings in great detail just like a main frame computer adventure! How do you tame the guardian of Hell's gate? What does the mysterious machine do? Where is the famous golden apple? Find out in UNDERGROUND.

32K Extended Basic Required  
PRICE: \$26.95 (Disk Only)

## GALACTIC MATH

GALACTIC MATH is not like any other math tutor program on the market for the Color Computer! This program has been written as an arcade game! The player becomes involved in playing the game and forgets that he/she is supposed to be learning! The student must enter the answer to a math question that is shown in the body of a flying saucer moving down from the top of the screen. There are four saucers moving down from the top toward the player. The player must maneuver his base under the saucer, enter the answer to the problem, press the spacebar to fire the laser. A new saucer with a new problem replaces the one just blasted. The score, time in play, number of hits, number of misses, and number of bases left to the player are displayed at the top of the screen. All of this in high resolution graphics using the new 4 color mode on a black screen! There are four levels of difficulty, and you may select either addition or multiplication. Don't bore your kids with smiling clowns or happy faces! They want to play arcade games — let them play GALACTIC MATH and learn at the same time!

16K or 32K Extended Basic Required  
PRICE: \$15.95 (Tape)

GOT A MODEM AND ALL THAT IT SEEMS TO DO IS GATHER DUST? FIND A FRIEND AND PLAY SOME GAMES OVER THE PHONE! EACH ORDER HAS TWO SETS OF INSTRUCTIONS, AND TWO TAPES. SHARE THE COST WITH A FRIEND! THREE GAMES TO CHOOSE FROM AND MORE ON THE WAY SOON.

## DOUBLE CABLE

Tired of switching cables everytime you use your modem and printer? This is the fix!! Hook your modem and printer up at the same time! No more switching.  
PRICE: \$14.95

## Buttons!

Rainbowfest buttons still available! 2 1/2 inches in diameter. Various bright colors, yellow, green, red, blue, white & lavender. "Coco Widow," "Coco Kid," "6809 Power," "Coco Nut," "I Speak Basic," \$1.00 each, six for \$5.00; colorful rainbow design, \$2.00 each.

## COUPON

10% off when sent with order or mention this coupon when ordering by phone.

## MODEM IAGO

We put our popular IAGO game (similar to Othello) in MODEM form. Now you can play it over the phone! Make your move, the pieces are flipped for you, select a message, press a button, and seconds later your opponents board is updated with your move. If you decide not to send the move you made, press a key and take it back. Super game!

16K or 32K Extended Basic Required  
PRICE: \$19.95 (Tape)

## MODEM CHECKERS

Same fine features as the chess game. You can make multiple jumps! Crown pieces. Send messages. Everything is automatic!

16K or 32K Extended Basic Required  
PRICE: \$19.95 (Tape)



## MODEM CHESS

You and a friend can play chess over the phone. The pieces are displayed on a high res graphics board. Move the pieces either with the joystick, or the keyboard. All moves are supported. Anything you can do on a regular chess board, you can do on this one. There is a message indicator which allows you to send messages each time you send a move. Make a move, select a message to send, press a button, and seconds later your opponent's board is updated. Has audio alerts; lets you know when a move is being made.

16K or 32K Extended Basic Required  
PRICE: \$19.95 (Tape)

## COLOR DISK SAVER

Disk bombed again? Can't really afford those expensive programs that might fix your disk? Anyone can afford the price of this program. COLOR DISK SAVER will save your sanity, as well as your disk. Don't wait until it is too late! COLOR DISK SAVER will save your disk to tape, reload the tape to disk if you ever need to restore the disk. Also has a tape verify command! Don't delay!

32K Extended Basic Required  
PRICE: \$12.95 (Tape)

## DD CLOCK

A *Real Time* clock that shows hours, minutes and seconds. You can type in and run your programs just as you normally would, while DD CLOCK is ticking away in the top right corner of your screen. And just in case you forget to check up on the time, DD CLOCK will sound a tone every hour. This program does not interfere with programming! You will notice no difference when running your programs. Many machine language programs are also compatible with DD CLOCK. This program uses one of the most powerful features of your 6809 microprocessor!

16K or 32K Required  
PRICE: \$9.95 (Tape)

## AUTOLOAD

AUTOLOAD will load any tape program or file and put it on disk for you automatically! Autoload will skip programs with errors and go on to the next program, either automatically or it will stop and wait for you to tell it to go on. Autoload will also fix all of those machine language programs that load either down in the disk system area or lower. You will no longer have to remove the disk controller before playing a game. Autoload will do all of the hard work for you, while you watch! All machine code program. Will not load copy protected programs.

16K or 32K Extended Basic required.  
PRICE: \$12.95 (Tape)

COLOR COMPUTER/TDP-100

## SUPER-PRO

### REPLACEMENT KEYBOARD KIT FREE PROGRAMS!!

Get a FREE utility program when you buy a copy of COLOR KEY COMMAND! Your choice of COLOR DISK SAVER, DD CLOCK, SUPER PEEKER, TAPE NAME, AUTOLOAD, or CURSOR II. Save up to \$12.95! COLOR KEY COMMAND is only \$18.95 (Tape) \* D.

\* All machine code D Disk Compatible

\$2.00 shipping and handling on all orders. \$3.00 charge on C.O.D. orders. Mastercard and VISA accepted. Texas residents add 5% sales tax. Allow two weeks for personal checks.

Send 20 cent stamp for free catalog.



Double Density Software  
920 Baldwin Street  
Denton, Texas 76201  
Phone 817/565-2004

\*Canadians\*

Kelly Software Distributors Ltd.  
P.O. Box 11932  
Edmonton, Alberta.  
(403) 421-8003



## ***DDH Directory-File Builder*** **An Enhancement For** ***Disk Data Handler***

There are so many ways to produce a disk directory that all of them would not fit in a 64K machine — they all seem to revolve around *DSKIS*.

*DDH Directory-File Builder* is no different in that respect. The difference is that this routine uses the power of your database program to do what it does best, manipulate data.

The trick is to read your disk directory and write it to a file in the format that can be read by your database. The objective is to minimize processing time. There was a nice BASIC program published in *80 Micro* which would read each disk and collect the data into a master directory, a complete library list. I patched *Qsortbin* from the June issue of *Rainbow* so the program would have a M/L sort routine. Even with this patch and three second sorting time, execution for each disk approached four minutes when dealing with three or four hundred records. I have a lot of data files.

The beauty of having a master library is to be assured that you have properly backed up those important disks with *all* the programs included.

The heart of the program is writing the data in the appropriate format which can be read as a standard file. In the case of *Disk Data Handler*, all records are handled as strings, making the conversion relatively easy.

Program execution is simple and fast. As quickly as the drive can read a directory, you are prompted to insert another disk or END. This routine can continue until you have about 500 program titles in the buffer of a 32K machine. You must then save this data to a file.

If you have more than 500 titles, you can resume with another session. Upon completion of reading directories, you must run *DDH* and load the directory files. Using the typical directory information, i.e., name, extension, type, format, and size, plus a disk label of 10 characters, *DDH* will process over 1500 records with the 64K version.

Sort time for 550 records was 15 seconds. I chose to add a 40 character "comment" field to each record which reduced the capacity of *DDH* to 500 records.

The best feature of *DDH Directory-File Builder* is that it provides an accurate, no hassle software inventory quickly. A hard copy listing can be customized to your needs through the reporting feature of *DDH*.

The directory program listing (it's very short) is being included with the *DDH* package at no extra charge. If you would like a copy of the listing, send a S.A.S.E. to Custom Software Engineering.

(Custom Software Engineering, 807 Minuteman Causeway  
D-2, Cocoa Beach, FL 32931)

—Ed Sehlhorst



**AUTOTERM**  
TURNS YOUR COLOR COMPUTER INTO THE  
**WORLD'S**  
**SMARTEST TERMINAL!**  
YOU'LL ALSO USE AUTOTERM FOR SIMPLE  
WORD PROCESSING & RECORD KEEPING



### **EASY TO USE**

ON-SCREEN EDITING via cursor. Full prompting and error checking. Key Beep and Error Beebop. Scroll bkwd/fwd while on line. Save/load files while on line. Maintain a disk copy of session. Automatic graphics. True lower case. Screen widths of 32, 40, 42, 50, 64. No split words on screen/printer. Print all or part of text. Search for strings. Well written manual goes step-by-step and has many KSM examples. Back cover is a cheat sheet.

**RECOMMEND 32K to 64K**  
**EASY UPGRADE**  
Price Difference +\$13

### **PLEASANTLY POWERFUL**

Total communications ability, 128 ASCII chars, 1200 baud, etc. Send text, graphics, BASIC, ML. Scan/Edit current data while receiving more data. Any modem. Fully supports D.C. Hayes and others. Any printer, page size, margins, etc. Override narrow text width of received data. Examine/change parameters, KSMs and disk directories at any time. Handles files which are larger than memory.

**CASSETTE \$39.95**  
**DISKETTE \$49.95**  
Add \$3 shipping and handling  
MC/VISA/C.O.D.

### **TRULY AUTOMATIC**

Create, edit, print, save and load Keystroke Multipliers (KSMs). KSMs automate almost any activity. Dial via modem, sign-on, interact, sign-off. Perform entire session. Act as a message taker. KSM may include parameter changes, disk operations, editing, time delays, looping, execution of other KSMs, waiting for part-specified responses, branching based upon responses.

**PXE Computing**  
11 Vicksburg Lane  
Richardson, Texas 75080  
214/699-7273

## VC Wargame Called Good Simulation

"You've been in Nam 90 days now but sometimes it feels like forever. No matter how well the Viet Cong are thrashed one day, it seems they're back in even stronger numbers the next." If this sounds like a very unpleasant scenario, it is, if you are in it. To warmongers, it's a boon.

VC is a new simulation for the Color Computer, that is different from all others. You are in charge of the Huy Bihn Province with 10 ARVN (Army of the Republic of South Viet Nam) units. Your mission is to eradicate VC activity in your area.

After watching a good title page you have the choice between six levels of play. Zero is very easy, while level five is nearly impossible. The board then sets up your units in a small bunch at the bottom of the screen. Small yellow pyramids are put all over the screen with small gaps. These represent neutral civilians. A neutral civilian could be one of three things, a VC unit, a North Vietnamese Army unit, or just a neutral civilian. How do you find out which one of the above they are, the hard way, of course. You move one of your units next to or on top of it, Vietnamese unit can positively identify it. The Air Cav can't tell if it's an enemy unit, unless it attacks you. To identify a civilian move a ARVN next to or on top of it and if it is friendly it will sometimes turn blue, if it is a VC it will turn into a red soldier

and attack you, a NVA does the same except that it is blue and red.

NVA units are bad news. Fortunately, they appear only on the higher levels. The artillery you can use to hammer away a enemy units, but if you don't destroy them on the first shot, you'll almost never get them. The VC turn neutral civilians into VC by sitting next to them for an unknown period of time or if possible will kill friendly civilians, which gives away their position for artillery. The Air Cav can only move into an unoccupied space, and artillery can't move. I found, by accident, that you never shell friendly units, word gets around and the friendly units all turn neutral!

The object of this madness is to destroy all enemy units, without having more than half of the civilians become VC of killed, after all how can you save a country if you destroy it?

As a wargame player, veteran of many battles in space, air, land and sea, I would rate the game high for a computer simulation. The documentation was a bit confusing since the Apple, TRS-80, Atari, and IBM instructions are mixed in, but not beyond comprehension. It is very nicely packaged in a box case with a picture and a description on the back. It includes the Atari and Model I-III versions as well as the Color Computer version. It runs in 16K tape and works without a hitch with a disk drive. You can use the keyboard or joystick to control movement.

(Avalon Hill Game Co., 4517 Hartford Road, Baltimore, MD 21214, tape \$20)

—Jeff White

### FILMASTR

The Color Computer has a powerful ally in FILMASTR. This is a DATA MANAGEMENT SYSTEM that you can trust. FILMASTR combines the best features of the big systems to provide a combination of speed, power, and ease of operation that can't be beat.

YOU are in complete control of this friendly program with no programming knowledge required. You design the data screen with up to 20 fields by moving the cursor on screen with the arrow keys and typing in the field names. FILMASTR takes care of all of the rest.

Enter data by just filling in the blanks. This form fill-in is easy and natural to use. You can even copy data from the previous record with one key-stroke. Add records, delete records, change records without fuss.

Tell FILMASTR to sort your file on any field that you want or to retrieve a particular record and the job is done with super-human machine language speed. FILMASTR will find a single record or a group of records that meet your request and will save those records as a separate file if you want to.

Controlled printing formats? Of course! Tell FILMASTR which records to use, which fields to print and in what order. You can control the print location to any position on the page. Mailing labels? You bet! All commands are given to FILMASTR with single key strokes. Press the HELP key (BREAK), and the available commands are displayed. Make your choice from the menu and let FILMASTR do the work.

FILMASTR can store up to 255 characters in each record and up to 24,000 characters in each file. (9000 with 16K).

**FILMASTR**    **16K or 32K**    **TAPE \$29.95**  
                   **EXT BASIC**                    **DISK \$34.95**  
   **AMDISK \$39.95**

Add \$2.00 Postage & Handling  
 C.O.D. \$2.00 Additional  
 PA Residents Add 6% Tax



## THE COMPUTER HOUSE

Box 1051 • DuBois, PA • 15801  
 Phone (814) 371-4658

## Battle: A Little Game That Grows On You

As a wargamer of some 20 years experience, I tend to think of the simpler games as rather trivial, so when I CLOADMed Aurora Software's *Battle*, the thought "just another battleship" came to mind. Well, not quite!

*Battle* is a two player game (with reasonable solo play capability) in which the two players take turns searching on the same low-res map for enemy ships. This has the unexpected effect of placing the two players in roughly the positions of allied destroyer captains searching for members of a hidden U-boat wolfpack. Each wants to make the kill, but the best chance for success is through cooperation with the other ship commander so that both may work at full effectiveness. If the players only compete against each other there will be a winner, but the winner will have a lower score than if the players had worked together to set out a formalized search pattern.

In addition to 12 hidden boats, there are 12 "bombs" (I think of them as mines) concealed in the map grid. A player is out of the game after hitting three "bombs." These and other details are listed on a short, but adequate instruction sheet.

At game start, players enter their names, which are displayed on the screen along with a running total of the scores. Also on the screen are the 10 x 20 zone map, a listing of the number of boats left unsunk (the 12 boats range from two to five units in length), and a score of "BOMBS HIT" by each player. A prompt in the lower left corner shows whose turn it is.

All in all, Aurora Software has produced a neat little game suitable for family play or cut-throat competition.

(Aurora Software, 49 Brookland Ave., Aurora, Ontario L4G 2H6, tape \$20)

—Nevin Templin

Graphics Bit . . .

## The Wallpaper POKE

Mark Charney, of Denville, New Jersey, writes, "I thoroughly enjoyed Jim Hall's article ("Graphics Special—The '78' POKE," October 1983). Hall mentions that he was able to produce various patterns with all the graphics commands except PCLS.

"After toying the some PEEKs and POKEs, I discovered that POKEing location 179 gives me various backgrounds when PCLS is used."

Here's a little Demo:

10 PMODE 3,1

12 SCREEN 1,1

14 POKE 179, RND(255)

16 PCLS

18 IF INKEY\$="" THEN 18 ELSE 14

## When In Rome Count Roman Numerals

That's also a good idea in most American elementary schools, where learning the Roman system is a traditional task. Whether you want to write outlines for English papers or simply figure out copyright dates for movies, Moreton Bay Software has a program, *Arabic Numbers: Roman Numerals*, that will help youngsters (or remedial adults) learn the conversions.

The program is straightforward: Two tutorials teach the conversions and a third tests the students on their mastery. The tutorials present the numbers and numerals in sequence to help understand the significance of the Roman symbols M, D, C, L, X, V, and I. Teaching *in sequence*, I believe, is a minor flaw in the program, since it permits students to guess ahead and thus avoid the necessary monotony of memorizing the code. The program unnecessarily increases monotony by sending students back to the beginning every time they make an error in the initial learning phases; thus it does *not* always reward them for items they previously mastered.

Once the basic conversion has been learned, the students are tested and the program provides bells and whistles for right answers and a raspberry for the wrong ones. It also keeps score and gives praise in the form of number puns: "GOOD 4 YOU." The program will supply correct answers to missed questions, but it curiously flips to its "RIGHT" mode after giving the answer, possibly giving students the mistaken impression they answered the item correctly.

The programmer missed a good bet, I believe, in not drawing on the potential of the CoCo (or any computer) to allow a student to break Roman numerals into their constituent parts on the screen and then figure out the numerical significance of the clusters. For example, instead of simply supplying a numeral:

MCMLXXXIV

and asking the students to decode it, the program could have reinforced skills by letting the student break it down on the screen something like this:

M=	1000
CM=1000-100=	900
LXXX=50+30=	80
IV=5-1=	4
MCMLXXXIV=	1984

Nevertheless, *Arabic Numbers: Roman Numerals* "works," teaching the conversions efficiently and accurately. The only complaints I heard from students were that the program was a little dull. It was agreed, however, that the program was a lot better than learning the same material in an arithmetic textbook.

The instructional manual is clear and helpful, and it contains some excellent supplementary information on the origins of Egyptian, Roman, and Arabic number systems.

(Moreton Bay Software, 316 Castillo Street, Santa Barbara, CA 93101, cassette, 16K, \$XVI.XCV)

—Stephen N. Tchudi

# Federal Hill Software

FINE PRODUCTS FOR THE COLOR COMPUTER, DRAGON AND MC-10

## Education Corner.....

### *Mi Coco Habla Espanol! Mon Coco Parle Francais!*

Two delightful new educational programs will help your youngsters learn Spanish and French! Each 16K program contains more than 500 basic vocabulary words built into an entertaining game format that encourages children to think as well as memorize! Colorful graphics and music make learning a joy. Three levels of difficulty with choice of translation from English to foreign language or foreign language to English. Ext. Basic required. French or Spanish, \$19.95 on tape, \$22.95 on disk. Both programs only \$34.95 tape or disk.

## Kokomath!

Are your kids bored by dull educational programs? Let Koko the Math Clown make arithmetic fun again. Get 10 problems right and give him a bath! Add, subtract, multiply or divide at three difficulty levels. Colorful graphics and music make this a kid tested winner! Will run on any 16K CoCo. Extended Basic is NOT required. Only \$16.95 on tape.

## Play Blackjaq!

This is as close as you can come to the real thing without losing your shirt! A full casino simulation, with up to 5 players and 9 decks. Play with friends, play all five hands yourself, or let the computer play the vacant hands. But watch out! It plays by card counting rules! There's even a joystick option for two players. Blackjaq keeps track of winnings and losings, displays two card-counting algorithms and prints out the results of every hand if a printer is on line! Nothing else like this available in 16K. Great for the beginner or experienced player. Requires 16K Ext. Bas. Only \$24.95 on tape, \$27.95 on disk.

*"Blackjaq is an excellent program which should be bought by all players who plan to go to a casino or who wish to know how we counters work."*

Rainbow, Nov. 1983

## 64K Breakthrough!

Did you feel gypped when you found out your "64K" computer still had the same old 32K in Basic? We sure did. So we've developed HID 'N RAM, a program that will access that "hidden" 32K from Basic and use it for data storage. Write a 28K data handling program and still having 32K left for the names, numbers and addresses you're crunching! HID 'N RAM is a brief ML driver embedded in a Basic demonstration program—a mailing list that puts 500 entries in RAM! This shows you how it works. Then you can delete our program and write your own. The ML driver stays with the program! Complete documentation and programming guide. Only \$24.95 on tape, \$27.95 on disk.

## Printer Artist

This unique printer utility introduces the Color Computer to the little known but delightful craft called "Artyping." This is the art of creating pictures using typewritten characters, and Printer Artist puts it at your fingertips. It includes two programs with 12 ready-to-run drawings of ships, birds and animals, holiday and patriotic themes, famous Americans and more. In addition, there are two utility programs and instructions for 40 additional drawings. Create your own file of printer art and save it to tape or disk. Complete documentation. Only \$21.95 on tape, \$24.95 on disk. Requires 16K Ext. Bas.

## Tax Relief Now With Coco-Accountant II

If you pay taxes, you need Coco-Accountant II! This 32K home and small business accounting program has everything you need to keep your finances straight and make income tax a breeze. Lists and totals expenditures and income by month, account or payee, provides a year-to-date summary by account and figures your net cash flow. Provides a printed spreadsheet showing your year at a glance, sorts entries by date, lists most functions to screen or printer and saves your files to tape or disk. Flags tax deductible expenses and expenses subject to state sales tax. Even computes the sales tax you paid! A separate program balances your checkbook and prints a reconciliation statement. Up to 450 entries per file on 32K tape version, 500 on 32K disk and 700 on 64K disk version. Only \$24.95 on tape, \$27.95 on disk.



## The Handicapper



NEW! Now available for the MC-10 and Model 100. Use the power of your computer to improve your performance at the track! Separate programs for thoroughbred and harness tracks apply sound handicapping techniques to produce rankings for the horses in each race. Includes speed, distance, track condition, post position, past performance, jockey or driver's record and other attributes. Handicap a race in a few minutes and a whole card in less than an hour! Easy enough for the beginner, sophisticated enough for the veteran horseplayer. Versions available for all CoCo's, MC-10's and Model 100's. State computer type and memory size when ordering. Thoroughbred or Harness Handicapper, \$24.95 each on tape. \$29.95 disk. Both programs only \$39.95 tape or disk.

## New From Owl-Ware!



NEW

# STELLAR SEARCH

Tape \$27.95  
Disk \$30.95

32K only

Stellar Search, our newest software addition from Owl-Ware, is the greatest graphics adventure ever! If you don't believe us, look at the review in the January Rainbow. Graphics like color paintings! As captain of the Enterprise, you must establish contact with an unknown race while the enemy tries to do you in. A total of 86K in four parts for 32K Extended. An incredible variety of adventure and arcade game experience! Only \$27.95 on tape, \$30.95 on disk.



## The Official BASIC09 Tour Guide

By Dale L. Puckett

Just off the press! Learn BASIC09 from the inside out with this official Microware introduction to BASIC09 programming. Unleash the power of your OS-9 operating system with the language that was created for it. Only \$18.95.

Send check or money order to FEDERAL HILL SOFTWARE, 825 William St., Baltimore, MD 21230. Your personal check is welcome—no delays. Add \$1.50 per order for postage and handling.

## Getting Even With The Byte Bat

I was keying in the seventh page of an eight-page Adventure game, hours upon hours had passed — just one more page and I could play that long awaited game — when it happened. The telephone rang, I answered it, turned to glance at my CoCo and the screen was snowy. Beau, our overzealous retriever, had gone behind the table to “retrieve” his play duck and disconnected the computer. I hung up the phone and Beau fled in terror, knowing the fury that was about to ensue. I ran to my secret hiding place, grabbed the bat, dashed to the CoCo and beat the keyboard and monitor with it, screaming every expletive known to mankind — I even made some up.

Yes, my chips were down but they weren't destroyed because they were the victim of my Byte Bat, a 17-inch soft, foam rubber “aggression/frustration” bat, by MicroTie Systems Corp. This light blue “anger reducing device” is an accessory no computer user should be without.

The Byte Bat comes with a witty user's guide, an 11 x 17-inch “Strike Back” wall poster, a decal which says “Warning, this computer friendly liveware is protected by Byte Bat,” and a button.

There are three recommended “digital interfaces,” or ways to grip the Byte Bat. The first is the Bi-Bit Grip, which

should be used when you feel only a little stress and frustration. Using the thumb and index finger, firmly grip the bat and smash away. Care must be taken when using this interface because of its two-finger flimsy grip — the bat may fly out of the aggressor's hands and into an innocent co-worker's (or family member's) face.

During those days of high level frustration, using the Binary Grip is most comforting. This grip uses the thumb and four fingers — like the customary tennis grip. It's kind of like clenching your fist. Get the picture?

Thirdly, and deadliest of all, is the Byte Grip, using the thumb and *seven* fingers from one hand. This interface is recommended only in extreme cases, such as system failure or job failure (when you are thinking of ways to kill your boss . . . or retriever).

The Byte Bat is used and measured in “B.A.U.D.” Rates (Basic Aggressive Units of Dissatisfaction) which range from one to 12,876,453. There is a warning for B.A.U.D. rates in excess of 100 — it may be hazardous to the aggressor's wrist, arm and psyche. My B.A.U.D. rate has been measured at 12,000. Care to top that?

The user's guide also includes hardware and software applications. For example, “Use of the Byte Bat is recommended when: You set up the printer to print the listing for your new program overnight, and return to find that all 25,000 lines have printed on top of each other due to a paper jam.” Or my favorite, “When your speech synthesizer begins to stutter or speak only Portuguese.”

But what about the little darlings at home to destroy your computer work? Well, “liveware applications” are also included in the user's guide. “Use of the Byte Bat is recommended when: Your three-year-old washes all your discs for you, as a special treat.” And, yes, it is recommended for all computer widows and widowers.

As you might have guessed, the Byte Bat is excellent for office use. It has been a favorite frustration device here at *the Rainbow*. When it arrived, the editorial and art departments gathered around for the unveiling. Everyone got their turn at bat, too. Now it is only used in serious applications — like deadline week, or a partial crashing of a *Rainbow On Tape*.

I recommend the Byte Bat for all computer users. It can be used for the office or at home, although the carton warns that it should be kept away from children under the age of three, since pieces of the foam rubber may be bitten off and swallowed. The Byte Bat is fun, and most importantly, serves its purpose — as a safe, frustration relieving way to beat up your CoCo, or any other person or animal who stands in your way of computing. Who says man's best friend is a dog?

(MicroTie Systems Corp., P.O. Box 8112, Walnut Creek, CA 94546, \$12.50)

— Susan Remini

## COMPUTER FORMS

Continuous forms, labels, paper, checks, invoices, statements—with your imprint. Continuous letterhead with a perf so fine that you need a magnifying glass to tell it's a fan fold sheet. Matching envelopes.

Regular letterhead, business forms and cards also.

Send sample for quote.

Computer/Printer supplies and furniture.

Send \$3.00 (refundable on first order) for our 76 page full color catalog.

## DESERT PRESS, INC.

P. O. Box 15128  
Las Vegas, Nevada 89114

Hints . . .

## Disk or Cassette I/O Errors?

Make sure that the disk drive(s) and cassette recorder are not on the left side of the TV set (or if they are, that they're at least half a foot or so away). This is because the flyback transformer (which is almost always on the left side of the TV) puts out a great deal of RFI that can interfere with cassette or disk operation.

— Ed Ellers



# THE UN-DISK

Now . . .  
VDUMP  
A utility to  
load and save all  
your memory!  
\$14.95



## UN-BELIEVABLE

But true! There *is* a disk drive in your Color Computer . . . and it is faster and more efficient than any "hardware" drive you can buy, for any price. This new "disk drive" is called VDOS—for Virtual Disk Operating System—and it will absolutely revolutionize the way you operate your CoCo.

VDOS lets you use the "extra" memory inside your CoCo as a virtual disk, with programs (any programs) stored out of the way. You can "save" and "load" programs from your in-memory

disk into working memory, and then run them. When you're done, you can simply access your in-memory disk again . . . and save or load another, and another.

And VDOS is fast. Because you are using memory rather than a mechanical device (like a disk drive or cassette player), programs load instantly. Yes, VDOS is faster than a disk!

VDOS works with all Color Computers—from 16K non-extended to 64K extended. Obviously, the

more memory you have, the greater number (and length) of programs you can store. For a 64K system, VDOS also uses the "unused" part of memory, providing up to 50,000 bytes of storage! Now, that's some disk!

We call it VDOS because in the future there will be utilities for your VDOS UNDISK that will give even greater capabilities—such as a full one-pass memory dump to cassette. Other utilities are planned, too.

We believe VDOS is the

greatest advancement for CoCo since the introduction of the *disk drive* itself. And, at less than \$100, it is so inexpensive you can't afford to be without it. If you have the "cassette blues," VDOS *is* the answer!

Finally, VDOS is simple to operate. It is entirely self-prompting and comes with a complete manual. But you almost don't even need the instructions—it requires absolutely no technical expertise.

VDOS. The answer to your prayers.

Cassette: \$49.95 Add \$1.50 shipping and handling; Canadians add \$5 for shipping; Foreign points add \$9. VISA and Master Card accepted. All Kentucky residents add 5% sales tax. Payments accepted in United States currency only.



Dr. Preble's Programs  
6540 Outer Loop  
Louisville, KY 40228  
(502) 241-6474  
Dealer Inquiries Invited



# The Programmer's Guild Means Adventure!

## Deadly Duology Death Dreadnaught

From the eerie interior of a wrecked starship comes an Adventure unlike any you have ever played. This program is so violent in its descriptions and so deadly in its playfield that caution is advised in allowing small children to play it unsupervised.

You are exploring the wrecked interior of an alien vessel that has been utterly devastated from within. Its crew has been murdered, its engines fused and destroyed. Your job is to escape. Because whatever did all this **knows you are here.**

**Get food. Get air. Get batteries. Get what you need and get it quickly before whatever it is that lurks in the shadows gets you.**

**Death Dreadnaught** is traumatic, dramatic, ecstatic and dynamic in a way only Text Adventures can be. Every word oozes of the danger that awaits you if you tarry too long.

**Rated R due to extreme descriptions of violence (may be too intense for children under 10).**

**Death Dreadnaught**, \$19.95, shipped postpaid to **your** galaxy today.

## The Domes Of Kilgari

The spine tingling sequel to **Death Dreadnaught** is now a reality.

You've escaped from the Death Ship only to crash land on Kilgari, the most desolate chunk of rock and sand in the universe. Your only hope for continued survival — penetrate the Ion station and get enough fuel rods for liftoff.

But there's a presence here that somehow brings back memories of that nightmare aboard the Dreadnaught. Could it be that the hellspawn creature you left behind has somehow caught up with you?

**Interspatial Digitron** has trapped and wired the domes so that intruders are destroyed. If you can get the rods, decode the alarms and return to your ship, you just may be able to go on breathing.

**Domes Of Kilgari**, the ultimate space Adventure, is uncluttered by pictures or graphics of any kind. It is pure descriptive english that gives you the clues. Your wits against that of **Digitron** and the nameless fury that dogs your trail.

**Domes of Kilgari**, the ultimate escape, \$19.95, shipped postpaid to **your** galaxy today.

**Dreadnaught Chronicles** — Both Adventures on two tapes in a handsome double package. **Only** \$29.95 postpaid.

**MAIL ORDER ONLY! GET YOURS TODAY!**  
**MASTERCARD AND VISA ACCEPTED.**

THE PROGRAMMER'S GUILD  
P.O. BOX 66  
PETERBOROUGH, NH 03458  
—or Call (603) 924-6065 for COD—

## Tee Off: A Challenging Round Of Micro-Golf

*Tee Off* is a golf game for a 16K Extended BASIC CoCo or TDP-100. The game comes on a cassette with a two-page instruction sheet. *Tee Off* can be played by one to four players, each player taking his turn at each hole in rotation. Unlike the real game of golf, each player is required to complete each hole before the next one can start. However, all players must complete a hole before any of them can continue to the next. The game is played with the right joystick, as are most single joystick games.

The game consists of nine holes of golf. Each hole is comprised of a series of sand traps, water traps and cactus in place of trees. I guess the writer lives in the southwest where there is an abundance of cactus. If a player wanders into either the sand traps or the water traps, he is required to play his way out. In the real game, that is true for the sand trap. However, when a shot is placed in the water, the player is required to drop another ball no closer to the hole than where he entered the water and take a penalty stroke. This version allows the player to *play his way out of the water*. Of course, each stroke must be quite firm and strong or the ball will hardly move at all. This could make it very unwise to take a shortcut across the water trap.

The ball is hit by placing the golfer and club such that the tip of the club is just touching the ball. The angle between the club and the ball will determine its direction. The golfer will always wind up in a counterclockwise direction. Once the golfer is positioned, holding down the firing button will start his windup. The longer the fire button is held down, the larger his windup will be and the further the ball will travel. That is, unless an obstacle is encountered. Thus, the distance the ball is to travel is dependent on the amount of windup and any obstacles in its path.

Once the ball has been hit to the green, the screen will change and present an enlarged green. The method used here is the same as on the fairway, except now the ball will travel further with a lighter stroke—the characteristics of a true green.

The entire procedure is repeated for each of the remaining holes. Once all nine holes are finished, the round is complete and the game can be restarted for, say, the back nine.

The game is loaded from cassette using the *CLOADM* "TEEEOFFF" command. Once in, the program is started using the *EXEC* command. The game presents a grid with a square in the middle of it. Instructions are presented indicating that if the color of the square is not blue, press the reset button until it is. Once completed, you are ready to start the game. You will be asked for the number of players which will be playing. In all cases but one, I only used the one-player option. As you progress around the course, you will be presented with various par holes, which perform doglegs to the right and left.

In playing the game, I found the graphics to be of good quality. The course was well laid out with the usual amount of hazards presented. The motion of the ball is smooth and the club swing consistent. The player is sort of a stickman who on some occasions has the nasty habit of being split between the right and left part of the screen. If you are playing near the borders, that part of the player extending beyond the boundary of the screen appears on the other side.

I did get into some positions from which I found it impossible to hit the ball in the manner I wanted to. In one case, on the fifth hole, I found myself about one inch from a cactus. Each time I tried to hit the ball toward the cactus, or even

near the cactus, the ball would not move, but I did receive a stroke. At first, I thought I was not properly positioned on the ball, but then I noticed that the stroke count was going up. I was forced to play a shot parallel to the cactus in order to move the ball. Once it was above the area of the cactus, I could play the shot I had wanted to.

When the ball hits the out of bounds marker, it has a tendency to slide along the out of bounds marker like it was a wall. I found it takes quite a bit of practice to get the player positioned where you want him. In some cases, the response to the joystick movement seemed quite sensitive and, in other cases, it was almost nonexistent. I found that the fine adjustment took quite a bit of practice and patience.

All in all, I found the game to be amusing and fun to play, as long as the player could live with the positioning difficulties. I enjoyed the game and actually found myself getting a birdy on seven, the second time around. The graphics are good and the player action is smooth. The ball travel is smooth and consistent from round to round.

The game is fun and challenging. It represents its real challenge in the form of par, as it should. It is not easy to get par on some of the holes, and I believe that is the way it should be. I did find that a return to center joystick would help considerably, but that is due to the way Radio Shack joysticks are built and not a fault with the game. The game is fun to play and does provide a fairly good challenge to break par.

(Prickly-Pear Software, 9234 E. 30th Street, Tucson, AZ 85710, \$24.95 on tape, \$29.95 on disk )

—Frank J. Esser

Now a LOGO for the  
**COLOR COMPUTER**

**TINY TURTLE**

TINY TURTLE is an affordable, fully compatible LOGO language with high resolution turtle graphics, music, fast processor operation, and retrieval of user procedures. TINY TURTLE comes complete with soft copy reference user manual.

32K/EXTD BASIC	
CASSETTE or DISK	\$39.95
HARD-COPY MANUAL	\$4.95

ALSO

GAS MILEAGE MONITOR	
DISK	\$9.95

SDS COMPUTERS                      BOGOTA, NJ  
POB 450    07603

NJ ADD 5% TAX

## Color Tutor — A Meat And Potatoes Utility

Many people who are contemplating purchasing a computer often ask the question, "What do you do with your computer?" I can think of a number of reasons for owning a computer, but they usually don't impress the person asking the question. Learning programming or playing games just doesn't cut the mustard in the minds of those who see the computer more as a tool than a hobby. Even balancing the family checkbook doesn't go over since most will argue that they can do it faster with a calculator. However, those of you with school-age children have a ready made justification — education. By education I don't mean learning BASIC — not everyone has to be a programmer. But, as everyone knows, the computer is a very useful tool for presenting material to youngsters that they must learn by rote such as state capitals, vocabulary drills, foreign language, math problems, etc. *Color Tutor* by Elite Software is such a tool to assist in this endeavor.

*Color Tutor* is the kind of program that everyone says they will write for Johnny or Suzie when they first buy their computer. But let's face it, not many of us do it. The program comes on tape, but a disk version is also available. It can be used with a 16K machine but requires Extended

BASIC. After loading the program and typing *RUN* (the program comes on a non-protected tape and can be saved to tape or disk and since it is written in BASIC it can be modified), the following menu appears:

- (1) TYPE NEW LESSON
- (2) LOAD LESSON FROM TAPE
- (3) EDIT LESSON MATERIAL
- (4) SAVE A LESSON TO TAPE
- (5) STUDY LESSON
- (6) EXIT PROGRAM

While all of the items in the menu are self-explanatory, several comments are in order.

To prepare a new set of questions and answers, one selects item 1 from the menu. *Color Tutor* then requests the number of questions to be entered and then prompts you for each question/answer pair. A maximum of 50 questions may be entered, however in a 16K machine it is suggested that the question length be limited to 32 characters, but with a 32K machine the question length is 64 characters. For most drill type questions this is not a severe limitation.

Option 3 is provided to permit editing of a lesson. Now this is not a word processor type editor. *Color Tutor* simply asks for the number of the questions or the answer or both. Since the type of questions and answers which you might use with *Color Tutor* will usually be short, this type of editing is not a disadvantage. One interesting aspect of the editor is that it is password protected. The purpose of the password is to prevent the student from accessing the questions and answers through the editor and thus alter them. While it is interesting that Elite took the time to add this option, it is

### ATTENTION, CoCo OWNERS!

**STOP** changing Printer & Modem Cables! Our **PARALLEL PRINTER INTERFACE** provides **SWITCH SELECTABLE PRINTER** or **MODEM** operations. It features switchable baud rates from 300 to 9600; comes complete with power supply, modem cable & "CENTRONICS" type printer cable.

**pbh Computer Products, Inc.**

P.O. DRAWER 55868  
HOUSTON, TEXAS 77055  
(713) 956-0207

ORDER DIRECT FROM US OR FROM YOUR  
INDEPENDENT COMPUTER RETAIL STORE.

Only \$89.95 plus \$3.00 Shipping

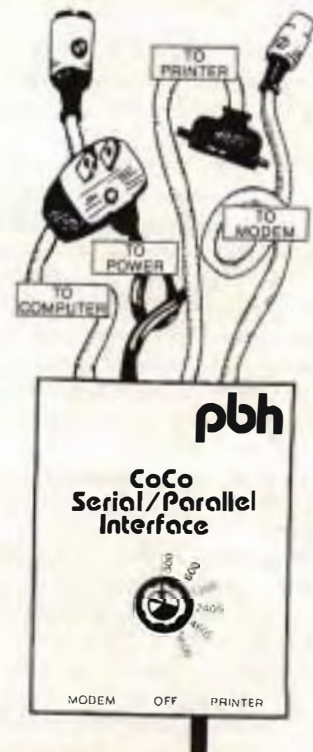

disappointing the way they handled it. The user does not have the option of choosing his own password which could be saved with each lesson — a simple item to program. Rather, the password is specified in the program and can't be changed by the user unless he does some reprogramming. This is an item that I feel Elite could improve upon.

Option 5 is chosen when a lesson is to be studied. Upon choosing this option, *Color Tutor* will randomize the questions and then present two options for choosing the correct answer. With the first option, the answer must match the correct answer with the exact spelling. The other choice checks the spelling of the answer with only the first three characters of the correct answer. Each question is then presented and a score of the correct vs. wrong answers is kept. At the end of the lesson the student is presented with the option to repeat the lesson.

*Color Tutor* performed exactly as described in the brief but adequate directions. To check out the program I chose to enter 50 questions — the limit of the program. For my questions I chose the state capitals. After entering the questions, I first saved the lesson to tape. It prompts the user for the file name and then immediately starts the recorder, ie. *Color Tutor* does not prompt you to set the recorder to record mode. Fortunately, I anticipated this possibility and had the recorder ready. This "glitch" should obviously be corrected as it is bound to cause some inconveniences for most people. Almost every program which I have purchased provides a prompt to ready the recorder. I would hope that Elite would take care of this problem. But, once loaded, the lesson ran as expected — of course, I didn't know all the state capitals and I won't mention my score either.

*Color Tutor* is a meat and potatoes program. It does what it is supposed to do, which is better than a lot I've seen. In other words, no bells and whistles or blinking lights or musical renditions — some might argue that this is a disadvantage since reinforcement for a correct answer makes learning more fun. But, the important thing is that it is a nice little educational utility program to have around when there is the need to review school assignments.

The major limitation to *Color Tutor* is in the method of answer checking. Either the answer must be spelled correctly or the first three letters are checked. This is okay for single word answers but obviously a problem for the more complex answer. For those who feel that this is a severe limitation, I would suggest the more sophisticated CAI type programs such as Radio Shack's *Color PILOT*, which is also considerably more expensive. However, I think most will agree, *Color Tutor* is very useful in the home when there is the need to study material such as mentioned above. I definitely recommend *Color Tutor*, but I personally feel that it is slightly overpriced.

(Elite Software, P.O. Box 11224, Pittsburgh, PA 15238, tape \$19.95, disk \$22.95)

—Donald D. Dollberg

See you at  
**RAINBOWfest**  
Feb. 17 — 19

**COMPUTIZE INC. PRESENTS. . .**  
**The BEST in Coco Utilities**

**"SPIT-N-IMAGE" (C)**

M/L DISK BACKUP UTILITY

Tired of spending all those \$\$\$\$ for that Disk Software that you can use and not Backup???? Then "SPIT-N-IMAGE" is for you. Creates a Mirror Image of Most popular Diskettes which do not respond to normal Backup functions. "SPIT-N-IMAGE" also initializes and Backs-up standard Diskettes in one pass

Requires 32k CC and 1 or 2 Disk Drives

Cassette **\$24.95** — Diskette **\$29.25**

**"TAPE-N-IMAGE" (C)**

M/L CASSETTE BACKUP UTILITY

Frustrated at not being able to Backup your valuable Cassette Based Software????Then "TAPE-N-IMAGE" is for you. It creates a Mirror Image of Most popular Cassette Software -M/L, Basic and Data - that do not respond to normal Backup functions.

Requires 16k or 32k CC

**\$9.95**

**"COMPSORT" (C)**

A Machine Language Sort for quickly sorting single dimensioned Basic String Arrays. COMPSORT is written in Position Independent Code, takes 142 bytes of storage, and is callable from Basic. Ideal for mailing lists, database, etc.

Requires 16K Extended CC

**Cassette \$9.95**

**"BARMASTER" (C)**

PROFESSIONAL BARTENDERS GUIDE

\*Menu Driven! \*Over 180 Listings! \* Easy to add your favorites!  
\* Print to 3X5 Index cards for easy reference! \* Access drink by name or liquor content! \*Utilizes computizes "Fast Access Record Retrieval" (any record in just two reads!)

Requires 32K CC and 1 Drive

**Disk Only \$19.95**

**"T. T. U." (C)**

TRIPLE TRANSFER UTILITY

1. Transfer contents of most Disks to Tape!
2. Transfer contents of most Tapes to Disk!
3. For those cassette based programs that conflict with Disk Operating System - will automatically relocate!

\*Copies ASCII, Basic, & M/L.

ALL CONTAINED IN 1 MENU DRIVEN PROGRAM!!!

REQUIRES 32K CC EXT

**CASSETTE \$19.95 DISKETTE \$24.95**

Check or M.O.

**COMPUTIZE INC.**  
**P.O. BOX 207**  
**LANGHORNE, PA 19047**



Add \$2.00 Shipping  
PA Res. add 6% sales tax

**215-946-7260**

**WANTED**

UTILITY PROGRAM AUTHORS

WE PAY TOP \$\$\$'s DROP US A NOTE!

## Mansion Of Doom— A Fun, High Quality Adventure

Webster's dictionary definition for 'adventure' is "an enterprise or performance involving the uncertain or unknown." However, I do not think that he had a computer Adventure in mind when he wrote that.

*Mansion of Doom*, by Pal Creations, is a high quality Adventure game made for the 32K Extended BASIC Color Computer. It comes on an easy to load five-minute tape with a single copy saved on each side. The instructions say to unplug your disk interface, if you have one, before loading the program, which would then make it very inconvenient to use for people with disk drives. However, I have discovered that a simple *PCLEAR* will allow you to run and save the program to disk with the disk interface plugged in.

The program takes exactly two minutes to load from cassette, and about eight seconds for a disk. It is written in 100 percent BASIC and is almost 18K long. There are no graphics in the program, but that is more than made up by the 76 rooms, 65 objects, 11 user verbs and six different directions (U,D,N,S,E,W,). The instructions, although only half of a single side of a piece of paper, are sufficient. There are instructions in the program also. It seems that the program could have been put on a 16K computer if they had left out the instructions and stripped and compacted the pro-

gram with some sort of compressor program. As to why they didn't, I really don't know. It would have allowed a wider range of people to purchase the program.

You have been chosen to rescue Princess Marlena who has been kidnapped by the evil Count Von Steinhoff. To do that, you must enter his mansion on the edge of town and try to find her, hopefully alive! Others have gone inside the mansion, but not one of them has ever left!

Once you enter the mansion you are met by vampires, bats, werewolves, and other creepy creatures. You can, as previously mentioned, travel in six directions, which is in my opinion, a welcome plus. However, there are only 11 verbs, which is rather inconvenient. For example, I like to use the word TAKE when I would like to acquire something. But the program only recognizes GET, and I was continuously bombarded with a screen of all the available commands (another plus) when I forgot to use GET instead of TAKE. Also, there is no way to save your position to tape, so you can quit and continue the game where you left off later on. It shouldn't be a problem for the more advanced adventurer, who should be able to solve the adventure in about four to five hours, but if you aren't that good, be prepared to spend the night.

I could only find one bug in the program. When you get chained in the shackles, the only way to get out is to type "YORL." I couldn't find any other ones, although when you get to some certain places, you might think you are in an endless loop. You actually aren't, and it is not a bug in the program. Just be patient and you should eventually get out.

In conclusion, I think it is a fine program for most people. I would not recommend this for beginning or extremely advanced adventurers. Its level of play is most suitable for someone in-between. The price of \$14.95 is, in my opinion, rather high for a non-graphic Adventure game, but it is a very good program, and should give you hours of fun.

(Pal Creations, 10456 Amantha Ave., San Diego, CA 92126, tape \$14.95)

—Paul Gani

### KEYBOARD "BEEPER" CARTRIDGE

- ▷ ON BOARD SPEAKER  
produces feedback, reducing entry errors
- ▷ "IN-LINE" TRANSPARENT  
operation does not "use up" expansion capability
- ▷ NO MODIFICATIONS  
(hardware or software) to install or use
- ▷ SWITCHED INTERRUPT LINE  
allows power up into BASIC or game pack
- ▷ POWER INDICATORS  
monitor 5V, 12V and -12V supplies
- ▷ ACCESSIBLE RESET SWITCH  
ends "feeling around" behind computer



ENG SYSTEMS LABORATORIES  
8203 SPRINGFIELD VILLAGE DRIVE  
SPRINGFIELD, VA 22152  
(703) 569 8660

MC  
COD  
VISA

\$59.95  
plus postage and handling

SATISFACTION GUARANTEED

## Submitting Material To the Rainbow

Contributions to *the RAINBOW* are welcome from everyone. We like to run a variety of programs which will be useful/helpful/fun for other CoCo owners.

Program submissions must be on tape or disk and it is best to make several saves, at least one of them in ASCII format. We're sorry, but we do not have time to key in programs. All programs should be supported by some editorial commentary, explaining how the program works. We're much more interested in how your submission works and runs than how you developed it. Programs should be learning experiences.

We do pay for submissions, based on a number of criteria. Those wishing remuneration should *so state* when making submissions.

For the benefit of those who wish more detailed information on making submissions, please send a SASE to: Submissions Editor, *the RAINBOW*, P.O. Box 209, Prospect, KY 40059. We will send you some more comprehensive guidelines.

Please do not submit programs or articles currently submitted to another publication.

# HI - RESOLUTION SCREEN UTILITY

**HI-RES SCREEN UTILITY**  
**Featuring: Double Height Characters**  
 On Screen UNDERLINING  
 Best Character Tone Selector  
 Switchable Full Screen Reverse Video  
 True Upper & Lower case character set  
**PROGRAMMABLE LINE LENGTHS**  
 Programmable line lengths from 28 to 255 characters  
 28 Characters per line  
 32 Characters per line  
 36 Characters per line  
 42 Characters per line  
 51 Characters per line  
 64 Characters per line  
 Line lengths of 85, 128 & 255 are unreadable but can be very useful for seeing display layouts  
 All functions are easily programmable thru BASIC  
**FULLY BASIC COMPATIBLE**, including CLS & PRINT &

- FULLY BASIC COMPATIBLE
- DISPLAY FORMATS OF 28 to 255 CHARACTERS PER LINE
- FULL 96 UPPER LOWER CASE CHARACTERS
- MIXED GRAPHICS & TEXT OR SEPARATE GRAPHIC & TEXT SCREENS
- INDIVIDUAL CHARACTER HIGHLIGHTING
- REVERSE CHARACTER HIGHLIGHT MODE
- WRITTEN IN FAST MACHINE LANGUAGE
- AUTOMATIC RELOCATES TO TOP OF 16 32K
- AUTOMATICALLY SUPPORTS 64K OF RAM WITH RESET CONTROL
- REVERSE SCREEN
- ON SCREEN UNDERLINE
- DOUBLE SIZE CHARACTERS
- ERASE TO END OF LINE
- ERASE TO END OF SCREEN
- HOME CURSOR
- BELL TONE CHARACTER
- HOME CURSOR & CLEAR SCREEN
- REQUIRES ONLY 2K OF RAM
- COMPATIBLE WITH ALL TAPE & DISK SYSTEMS

## \$19.95

## INTRODUCING TEXTPRO III

"The Professionals" Word Processing System



- **9 Hi-Resolution Display Formats: from 28 to 255 Columns by 24 lines**
- **True Upper/Lower Case Display**
- **Three Programmable Headers**
- **Programmable Footer**
- **Automatic Footer System**
- **Automatic Memory Sense 16-64K**
- **Up to 48K of Workspace on 64K**
- **10 Programmable Tab Stops**
- **7 Tab Function Commands**
- **Automatic Justification**
- **On Screen Underlining and Double Size Characters**
- **Change Formatting at Any Time**
- **Edit Files Larger Than Memory**
- **Compatible with All Printers**
- **Easily Imbed Any Number of Format and Control Codes**
- **Typist Friendly Line and Command Format Entry**
- **Automatic Key Repeat**

TEXTPRO III is the most advanced Text Editing and Word Processing System available for the Color Computer. One of the reasons for this is, Textpro works in a totally different way than the other Color Computer Word Processing programs. It uses simple 2 character abbreviations of words or phrases for commands. These commands are used at the beginning of a line and are preceded by a "." period. Several commands can be chained together on the same line for ease of use. Through these commands you tell the Word Processor how you want the margins set, line length, indenting information, and so on. You can change the way you want a document formatted at any point in the document. You also have the freedom to write without worrying about how long the line is or where the margins are and so on. The Word Processor automatically takes words from one line to the next and fills out the printed line to the desired length. You can even use the command to Input Text from the Keyboard while a document is being processed, and use that information to change the formatting or enter any other valid text Processor command. With this kind of flexibility and an extensive set of commands and functions available, its no wonder that TEXTPRO III is the most advanced Word Processing System.

### Screen Formatting

Textpro III has 9 Hi-Resolution Upper/Lower case display formats available, from 28 to 255 characters per line by 24 lines. You also have advanced screen commands such as double size characters and on screen underlining. You can also use the standard 32 by 16 display for systems having lower case hardware kits installed. The display defaults to a 51 by 24 format that is easily switched to any other format available. Along with the Hi-Resolution screen we added automatic repeating keys "Typomatic." The rate is fully adjustable from ultra fast to super slow or can be turned off entirely for your convenience.

### 64K Support

Textpro III fully supports the use of 64K on the Color Computer. It has fast automatic memory sensing and configures itself accordingly. Textpro III does not require Extended Basic or Flex to take full advantage of a 64K RAM system. On a 64K Disk System there is over 64K of workspace available and files larger than memory are fully supported. Tape based systems have up to 48K available for workspace.

### Text Editor

Textpro III has a full featured, line oriented screen editor. It supports single or multiple line copy and move, global or local search and replace of any character string, character insert and delete, block delete, adjustable speed automatic key repeat, single and automatic line edit, programmable underline and double width control coded, change screen background color and line lengths, automatic line numbering, line resequencer, and insert and delete line numbers.

### Disk & Tape I/O

Textpro III uses fully compatible ASCII formatted files that do not have to be converted like some of the other Word Processing Systems. It will load, save and verify basic ASCII formatted tape files. The disk version supports Load, Save, Directory, Kill, Append, Text Process file from Disk, Roll part of file to disk and get next portion of file from disk.

**DISK \$59.95**

**TAPE \$49.95**

### Standard Commands

Textpro III features a whole host of Document Formatting commands. The setup command section includes: Line Length, Top, Left, and Bottom Margins, Page Length, Page Numbering on/off and Automatic Word Fill and Justification on/off.

Some of the vertical control features include: test for number of lines left on the page, skip to next page, set page number, wait at top of page, single and multi line spacing, and skip blank lines.

Textpro III features 3 programmable header lines that can be centered, left or right justified. It also has one programmable footer line. 3 commands for continues, single and paragraph indenting, center text, underline and double width print commands.

### Footnotes and Special Commands

Some of the special features allow imbedded control codes to access intelligent printer features like: superscript, subscript, change type font and even graphics. You can even imbed control codes within justified text. There is a command that automatically places footnotes at the bottom of the page, which can be very handy for term papers, etc. Another command allows you to display a message on the screen and input text from the keyboard. This text is then printed as if it has been part of the original text, thus you can produce things like a personalized form letter. There is also a repeat command that allows you to repeat an entire document or a part of one as many times as needed up to 255 times. This can be used to produce mailing labels or combined with the previous command to produce a selected number of personalized form letters.

### Tab Functions

Textpro III features an elaborate system of tab commands for complete control over column formatting. There are 10 programmable tab stops that can be defined or re-defined at any time in the text file. They can be used with the following tab commands: Center Over Tab Column, Right Justify to Tab Column, Decimal Align Over Tab Column, Left Justify to Tab Column (Normal Tab) and Horizontal Tab. Tab functions may also be used with a numeric tab column position for maximum flexibility. You can also define the Tab Fill Character to any printable character to fill in the blanks with dots, dashes, etc.

5566 Ricochet Avenue  
Las Vegas, Nevada 89110

**CER  
COMP**  
(702) 452-0632

All Orders Shipped From Stock  
Add \$2.50 Postage

# The Mini Modem And Colorcom/E: An Easy Way To Get Connected

by Ed Ellers

Greta Garbo once said "I want to be alone," but a lot of computerists would disagree when it comes to their systems. Many people are interested in getting their computers hooked up to the outside world of bulletin boards, information services and computer-to-computer communication over telephone lines. With the "Information Age" in full swing, one could argue that having a computer without a modem is almost like not having a telephone in your home.

Mura's MM-100 Manual Mini Modem is a low-cost alternative for those who want to jump into data communication without much of an outlay. For under \$80 you get a unit that does everything a modem has to do. The MM-100 will make the connection between your computer (not just the CoCo, MC-10 and Dragon, but almost any personal computer) and the phone line; the catch is that you must switch it on and off manually. The Mini Modem does not hang up at the end of a call, answer incoming calls automatically or dial numbers. Even so, the Mini Modem is very easy to use; it's simpler in some ways than more sophisticated modems. (The Mura is very similar to the Radio Shack/TDP Modem I; its operation is almost identical to the Modem I, but the Mini Modem's circuitry is much less complex.)

The Mura unit is a direct-connect modem, which means that it plugs directly into your telephone line jack (as opposed to acoustic couplers, which have a cradle in which

you place the handset of your phone). It is, of course, FCC registered, and legal to use on phone lines in the United States. One note here is that in some states local telephone companies are allowed to charge an extra monthly fee, which ranges from fifty cents (in Vermont) to \$49.50 (in Oklahoma), for the privilege of using their lines for data communications, or in some cases for using another device on the line. In a few states, you must have business service (at its higher rates) on the dubious grounds that if you are transmitting data you are "using the telephone for business purposes." Before buying a modem, check with the telephone company in your area about the tariffs governing modem use; if they don't tell you what you want to know, try your state's regulatory agency.

The instruction book does correctly tell you to notify the phone company when you connect the modem, but this is only a legal requirement since the Mini Modem does not place an additional load on the line and does not affect the operation of the phone company's equipment or (when it's switched off) your phone service. To get it going, you just unplug the phone nearest to the computer, plug the modem's cord into the phone line jack, plug your phone into the Mini Modem's jack and then connect the modem to the computer's SERIAL I/O jack. (Spectrum Projects sells the modem with a cable to connect to the CoCo.)

With the Mini Modem, a telephone (and of course the Color Computer), the only other thing you need is some kind of terminal program. The standard in the field, Radio Shack's Videotex cartridge (and formerly cassette), was designed strictly to communicate with information systems; you can't "download" a file (such as a program), save information to cassette or disk or print out what you receive. Along with the modem, I received a copy of Eigen Systems'

**BEAR BONES**

**COLOR COMPUTER SOFTWARE**

**BEAR BONES**

**EXCLUSIVE NEW! EASY-TO-DO**  
**"SOFT"-WARE FOR SOMEONE SPECIAL**  
**GREAT GIFT IDEA**

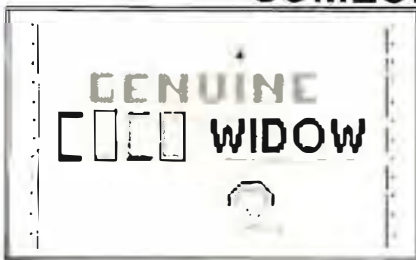

**COUNTED CROSS-STITCH CRAFT KIT FOR YOUR NEEDLECRAFT ENTHUSIAST**  
 Kits include all directions and materials. Worked on 14C 100% Cotton Aida cloth, with cotton floss.  
**9" x 12"**

**\$14<sup>95</sup> Each (Frame not included)**

**TITLES AVAILABLE:**

- A. "Genuine Coco Widow"
- B. "Computer Widow"
- C. "A Loaf of Bread, A Jug of Wine, — and My Computer"
- D. "Computer Genius I/O's Here"

**HOLIDAY SPECIAL ORDER 2 CRAFT KITS AND RECEIVE A FREE 16K ML "SOOPER PAC" a \$21.95 VALUE\***

**MAIL TO: BEAR BONES SOFTWARE, INC.  
 G-3117 CORUNNA RD., SUITE 108  
 FLINT, MICHIGAN 48504**

**Enclose Check or Money Order  
 Dealer Inquiries Welcome**

**ORDER FORM**

QTY.		PRICE
_____	COCO WIDOW	_____ \$14.95 Ea.
_____	COMPUTER WIDOW	_____
_____	A LOAF OF BREAD	_____
_____	COMPUTER GENIUS	_____
_____	<b>TOTAL</b>	_____
_____	Sooper Pac — FREE (1 FREE for Each 2 Kits Ordered)	_____

TOTAL: \$ \_\_\_\_\_  
 Mich. Res. Add 4% Tax \_\_\_\_\_  
**TOTAL ORDER: \$ \_\_\_\_\_**

**SHIPPING FREE**

SHIP TO: \_\_\_\_\_  
 NAME \_\_\_\_\_  
 ADDRESS \_\_\_\_\_  
 CITY \_\_\_\_\_ STATE \_\_\_\_\_ ZIP \_\_\_\_\_



Disk Colorcom/E Version 2, which is primarily what I used to test the Mini Modem.

With Colorcom/E Version 2, you can:

- Download a file (such as a BASIC program or a newsletter) from the computer on the other end (known as the "host").
- Upload a file from your CoCo to the host system.
- Print out a copy of any or all of your communications, or save them to disk.
- Do "auto-log-on," which means that Colorcom-E automatically types in your name, account number, password or whatever you would normally have to type when getting on a system.
- Read the incoming messages on a 51-column, 24-line screen with both upper and lowercase letters.
- Display weather radar maps, financial index charts and game graphics from CompuServe and some other systems.

Colorcom/E Version 1 was reviewed in *the Rainbow* in November 1982. Version 2 has added the 51 x 24 upper/lowercase display mode (much like that of Telewriter); it's a big help because most of the systems that you will be "dialing up" use a greater line width than the 32-character text screen built into the CoCo.

Disk Colorcom/E "V2" (as Eigen Systems calls it) has a menu that lets you select auto-logon sequences for several services. You can edit the files for the various procedures, and then set up the menu to select them. To log on to a particular service, you first press a number key for the service you want. When the file has loaded, the screen will show the phone number for that service (which you put in earlier). After you make the connection, Disk Colorcom/E will type in the account number, password or whatever needs to be typed. That's it! (I'm told that a cartridge version of Colorcom/E V2 is almost ready to be released; if you intend to buy the cartridge, ask about the availability of Version 2.)

The Mini Modem, like most modems, has two modes called "originate" and "answer." In general, you use "originate" when you make a call and "answer" when someone calls you. To call a bulletin board or some other service, you pick up the phone and dial the number and wait for the computer to answer. When you hear the high-pitched "answer tone," switch the modem to ORIGINATE and hang up the phone. If somebody calls you (say to transfer files), you pick up the phone and switch the modem to ANSWER; when the green CARRIER DETECT light comes on you hang up the phone. In either case, after you disconnect from the other system and the CARRIER light goes out, you would switch the modem off to hang up. (If you forget to turn it off, your line will remain busy.)

Using Disk Colorcom/E Version 2, I logged on to all the local bulletin boards at numerous times (driving one of the sysops to the point of distraction) as well as two out-of-town BBSes and CompuServe and The Source, using local and AT&T and GTE Sprint long-distance connections. In every case, the Mini Modem performed flawlessly, without a single character garbled as far as I could tell.

If you want to get on-line without emptying your wallet to do so, the Mura Mini Modem and Disk Colorcom/E together are one of the best ways to do it.

(Spectrum Projects, 93-15 86th Drive, Woodhaven, N.Y. 11421, \$79.95 + \$3 S/H, \$49.95 with purchase of Colorcom/E; Colorcom/E \$49.95 (cartridge or disk); cable for CoCo \$14.95 with Colorcom-E purchase)

## buy a Tandon disk drive for your COCO

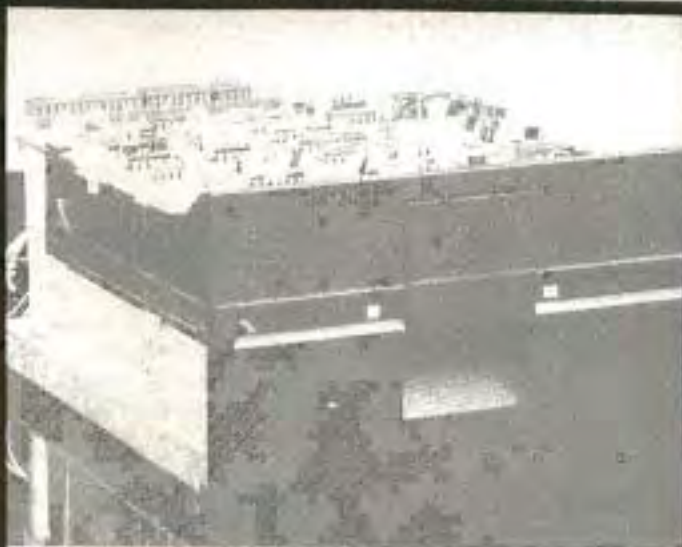

40 track fully compatible  
drive 0 includes a single sided Tandon disk,  
case and power supply, drive cable,  
and a Radio Shack drive controller board.  
**DRIVE 0 \$449. DRIVE 1 \$249.**

### DOUBLE HEADED DRIVES runs like two drives

**DRIVE 0 \$549 DRIVE 1 \$349**

**NEW! TANDON THINLINE**  
**drive 0 \$399.**  
SPECIAL INTRODUCTORY OFFER

**64K UPGRADE KIT**  
**\$62.95**

**C.Itoh PROWRITER \$425.**

**EPSON RX-80 \$399.**

**Botek Printer adapter \$69.**

**Use our watts line for a quote**

• TM Tandy Corp

## COMPUKIT

1-713-480-6000 order line 1-800-231-6671  
16206D Hickory Knoll, Houston, Texas 77565

ordering information  
We accept Visa, Mastercard, Wire Transfers, and Certified Checks for quickest shipping. Orders received on personal checks are held for clearance.

## Screen Reference Card Is No Ace!

It's very nice to find a program that does what it claims to do and is very easy to learn to use. *Screen Reference Card* (also known as *SRC*) is just such a program.

Unfortunately, there's nothing else good that I can say about it.

As the name implies, *SRC* is designed to put reference information on the screen so that you won't have to look it up in a manual or on a reference card.

On loading the program, you are presented with a menu that invites you to press 1 to 9. Pressing 9 crashes the program on an Undefined Line Error. Options 7 and 8 are reserved for "user defined" routines. That leaves six selections that actually do anything.

One choice will show "statement and function syntax." What you get is several screens that list various commands. You view different screens by using the up and down arrows. Among other things, you'll see a whole bunch of sample format strings under "print using"—without the slightest indication of the formats that any of them will produce.

"Operators and special characters" are listed in an utterly illogical order. The first line of this section tells you what the plus and minus signs do, in case you didn't know, and the third shows the asterisk and slash for multiplication and division. Doesn't *SRC*'s author know the priorities of operators?

If you select "X/Y coordinates," about all you'll really learn is that, on a graphics screen, there are 256 locations across and 192 down.

"Text screen locations" is a screen that, if read in conjunction with the instruction sheet, will show you where the *PRINT@* locations are.

"Graphic character codes" and "ASCII character codes" are self-explanatory.

On the "user-defined" options, the instruction sheet suggests that you might want to use one of them to write a routine that will display a list of *POKE* locations. No samples are offered.

Think about it. In order to write such a routine, first you'd have to make a list of the items to be included. And once you have researched and compiled the list, what in the world do you need the program for?

The whole premise of *SRC* is, in my opinion, flawed. The author thinks it would be faster and easier to use his program for looking up syntax and other information than to use a reference card.

Trouble is, the time when I need to know where the commas go in a *CSAVEM* statement, or what's the code for a red checkerboard pattern, is the time when a program that I'm working on is in the computer. It seems a waste of effort to save the program in progress just so I can load *SRC* to look up the answer.

For much less than the price of this program, you can get the Nanos reference card, which is much easier to use and far more informative. For command syntax, the red card that came with the CoCo is usually all you need (in spite of a few typos).

(CoCoData Enterprises, 1316 Quail Ave., McAllen, TX 78054, 16K ECB cassette, \$7.95)

—Neil Edward Parks

## 64K for \$99!

We will convert your Radio Shack Color Computer to a full 64K for only \$99.00 plus shipping. (Compare this with RS price of \$149 + \$30 labor for 32K upgrade.) Board models D, E and F — No matter what ROM you have — Typically 24 hour turnaround — Includes hardware modification to access the entire 64K, with special software and instructions on use of the upper 32K. Pack your computer well. Include cashier's check, money order, or personal check (allow 2 weeks for personal checks) for \$104.00 (\$99.00 + \$5.00 shipping) to PYRAMID. You may also pay by Mastercard or return COD. We will treat your computer tenderly and rush it back to you.

PYRAMID — 527 Hill St. - Santa Monica, CA - 90405 - (213) 399-2222

## ARE YOUR WALKING FINGERS GETTING FOOTSORE ?

Tired of typing in those long, but wonderful, programs from each issue of the *RAINBOW*? Now, you can get *RAINBOW ON TAPE* and give those tired fingers a rest. With *RAINBOW ON TAPE*, you'll be able to spend your time enjoying programs instead of just typing...typing...typing them! All you need to do ever again is pop a *RAINBOW ON TAPE* cassette into your recorder, CLOAD and RUN any one you want.

*RAINBOW on Tape* single issue rate is: within the US, \$8, Canadian and Mexican rate, \$10, all other countries \$10.00

*RAINBOW on Tape* subscription rate is: within the US, \$70 Canadian and Mexican rate, \$80, all other countries, \$95  
US FUNDS ONLY PLEASE

VISA, MasterCard and American Express accepted. All subscriptions begin with the current issue and back issues are available beginning with April, 1982. Tapes are sent first class mail to arrive approximately the same time as your current issue of *the Rainbow*.

Now . . .

### The Best Color Computer Magazine Offers The Best Tape Service

Think of it! Not 10 or a dozen—but between 20 and 30—programs every month from *Rainbow On Tape*. All the really good programs from *the Rainbow*! All the long ones . . . so you don't have to type them in. Just CLOAD and RUN!

**ORDER RAINBOW ON TAPE TODAY!**  
**HANDY ORDER CARD BETWEEN PAGES 34 and 35**

# Superior Graphic Software Products

TRS-80<sup>®</sup> COLOR COMPUTER<sup>®</sup>



**THE NUMBERS GAME.** Combines graphics and a voice track to teach basic number recognition. Your CoCo talks to the students, explaining each number shown, and tests on recognition and understanding. Extended color basic. TAPE ONLY .....\$14.95

**TALKING GRAPHIC DEMONSTRATION.** The ultimate show and tell program. Combines motion graphics, music background and voice commentary to show off your CoCo. As quoted in RAINBOW, "This is frankly, better than anything the people who sell the machines have." Extended color basic. TAPE ONLY .....\$19.95

**TALKING SPELLER.** Use your CoCo as a spelling tutor. Record your list of words, TALKING SPELLER will play them back, wait for response from the keyboard and keep score. Easy to use, and with lots of sound effects. 16k basic. TAPE ONLY .....\$19.95

**EL CASINO.** Three action packed, high resolution graphic games. Programmed with MPP graphics, each over 14k long. Includes DICE GAME, SLOT MACHINE and BLACK JACK. Ideal for rumpus room parties. Extended color basic. SPECIFY TAPE OR DISK .....\$29.95

**MPP TUTORIAL.** Programming tool of the professionals. Step by step instructions to create high resolution graphics, even animation. No M/L, or 6809 trickery. Quote CHROMOSETTE, "...if you want to see and use the full graphic potential of your CoCo, this program is required!" Extended color basic. SPECIFY TAPE OR DISK .....\$29.95

**DISK DOCTOR.** Have a "CRASHED" disk. Don't panic! Take 2 aspirin, count to 10, and put in an emergency call for the DISK DOCTOR. Salvage M/L, BASIC, ASCII, even MPP GRAPHICS files. 80 MICRO reviewer said, "I feel safer when creating important files or programs having the DOCTOR" on call!" 32k DOS .....\$39.95

**DATA DOCTOR.** Have the same file edit capabilities most sophisticated DOS provide. List files, examine, add and delete data, print files. Correct errors without having to run the system. 32k DOS .....\$39.95

**DIRECTORY DOCTOR.** Provide preventative medicine against crashed disks. Build a spare directory track, exchange it for a garbaged track when needed. Does not take up user disk space. 32k DOS... .....\$39.95

**DISK HOSPITAL.** The complete Disk utility package. Includes DISK DOCTOR, DATA DOCTOR, and DIRECTORY DOCTOR. Our doctors make house calls! 32k DOS .....\$69.95

Documentation for the above programs (refundable with order) .....\$10.00



ADD \$2.00 PER ORDER POSTAGE & HANDLING  
P.O. BOX 451 CANTON, NC 28716.  
For Fast Service Call 704/648-6015



## The Great Hamster Hunt — It's Even Fun For Fathers

Oh well, another Adventure game. Time to type in all those directions to find out where the hamster is hiding. But wait, what's this? Graphics, sound, and some real adventure. Maybe I'll take a look at this program.

*The Great Hamster Hunt* is not your everyday Adventure game. Most games of this type have provided the user the ability to move from room to room using one word commands. *The Great Hamster Hunt* expanded this concept into an enjoyable game for children, especially between the ages of three and 10.

After the game is loaded and run, a map of the house is shown. Each of the rooms is represented by an object that would be found in that room. The picture of a bed means bedroom, a stove is the kitchen, etc. The program user is represented by a yellow and red square which appears on the map. The square is moved from room to room on the map using the arrow keys. Once the user is in the selected room, the spacebar is pressed to enter the designated room. The room is drawn on the screen and objects that might be in a

room of this type are drawn in high resolution graphics. To move around the room, the user presses the arrow keys until the yellow and red box is on one of the objects. The space bar is then pressed to search that object for the hamster. The search is continued until it is sure that the hamster is not in that room. An M is pressed to return to the map and choose another room. When you are in a room and hear some spooky music it means that the cat is about to enter the room. When the cat slinks into the room it is time for your exit. Sometimes the hamster is seen scooting out of the room, sometimes it is not seen. The hamster may change rooms but it still might be hiding in the room. It may be searched again later in the game.

When the happy music is heard, you have found the hamster. The hamster is put in his cage. A well drawn picture of the hamster is displayed and some lullaby music is played to lull the hamster to sleep after it's long ordeal. The game may be played again or stopped at this point.

My first reaction to the game was not extremely positive. My five-year-old son took control of the game and had a great time playing it. He was excited and even learned something in the meantime. He was moving the cursor from my verbal directions. Right, left, up, down. After the directions were explained, little difficulty was encountered in understanding the game. Well, needless to say, my initial reaction was wrong. *The Great Hamster Hunt* is a great deal of fun. Even for fathers!

(Computer Island, 227 Hampton Green, Staten Island, NY 10312, 32K ECB tape, \$19.95)

—Rick Cobello

## LINE PRINTERS

\$ 149.<sup>95</sup>

CENTRONICS 588 (used) serial 600  
Baud, 88 CPS with 4 pin DIN plug

All prices F.O.B. Henderson, Tx.  
Terms: Cash, check or COD  
Tx. residents add 4% sales tax

LEADER SALES CORPORATION  
P.O. Box 1220, Henderson, Tx. 75652  
214/657-7800 after 6:00 P.M.

Discounts available to CC clubs  
and volume buyers.

INTRODUCING!

# KRON

WITH FOUR SCREENS

• TANKS • SPIDERS • BLOCKS • CYCLES •

Battle spiders! Blast your way through the descending blocks! Defeat the enemy tanks! Trap the menacing cycles! Increasing levels of difficulty make each a real challenge! KRON is a fast ML program with multi-colors, Hi-Res, and many great sounds. It displays the top five scores plus has a pause feature and display mode.

32K STANDARD-JOYSTICK

TAPE-DISK \$26.95-\$29.95

### KING PEDE

The ultimate pede game! You'll face up to eight different enemies including swarms of wasps. ML—multi-color.

32K STANDARD-JOYSTICK

TAPE-DISK \$24.95-\$27.95

### MEM-OS64

A 64K Menu Driven ML Utility which allows you to store multiple ML or Basic programs in the high 32K RAM then pull the desired program and Run/Exec it. It maintains a directory, displays the amount of free memory and length of programs, has a Motor/Audio On/Off command, a Load and Kill command, and allows the easy switching of programs with disk-like speed! With the Multiple Load feature, you can load several programs at once with ease!

64K EXTENDED

TAPE \$15.95

### PEEKCOPY

Copies tape-based software (even most autostarts), displays memory in Hex and ASCII, displays the Start, End, and Exec addresses of ML programs, allows the changing of memory, and more (ML)!

16K STANDARD

TAPE \$11.95

### REDUCIT

A ML program that makes your Basic programs use less memory and run more efficiently (faster) by combining lines and removing unnecessary spaces and remarks!

16K STANDARD

TAPE \$9.95

PLEASE ADD \$2.00 EACH ORDER, POSTAGE/HANDLING

**OREGON COLOR COMPUTER SYSTEMS**  
P.O. BOX 11468, EUGENE, OR 97440

# The OS-9 experts have developed something new.

## C Compiler Version 2 for color computer OS-9 DOS for color computer Relocatable Assembler for Flex and CoCo DOS

### C Compiler

Dugger's Growing Systems C is the original C Compiler for the 6809 and is the proven leader in the field. It is a growing subset of the C programming language. It runs in 20K, has assembly language output, position independent code, an extensive library in assembly language source, and code optimizer.

The Color Computer and Flex (which will run on the Color Computer) are now both available with full floating point package (float, long, for, goto, etc.) in addition to the basic C commands. CoCo Dos also contains features which use the BASIC ROM functions (cls, polcat, partial floating point, etc.).

Dugger's Growing Systems has the cost effective C for OS-9. It contains all the necessary C commands (while, if, if else, int., char, etc.) which may be linked, loaded, and used in a multi-user, multi-tasking environment.

### Relocatable Assembler

The relocatable assembler package includes assembler, linker, and manager. May be used with the Color Computer or Flex.

Symbols up to 32 characters  Many special characters allowed in symbols (\$, %, etc.)  Multiple files assembled without exiting the assembler  Direct output to printer at any time  Generates either absolute or relocatable modules which are linked together with RLINK to generate executables  Supports two types of global variables (VAR and COMN) Fortran type common  Compatible with source for most assemblers  Macros with parameters  Conditional assembly.

### Linker

Use text-like files which are generated by RASMB or any other source  Allows inclusion of multiple source files, each of which can have any number of program modules  Provide for library files, whose modules are included only as required  Specify at link-time execution address and global storage area for easy generation of ROM-able code  Will link together both absolute and relocatable modules  Extensive linkage information output on request.

### Manager

Provide a tool to build a "library" of relocatables  Edit feature to list, insert, and delete modules.



### Check and Compare Prices

CoCo.C Compiler Version 2.3 (requires disk assembler and text editor)	.49.95
Relocatable Assembler (package: assembler, linker, and manager) RASMB CoCo Version 1.7	.49.95
Flex C Compiler Version 2.3	.75.00
Relocatable Assembler (package: assembler, linker, and manager) RASMB Flex Version 1.7	75.00
OS-9 C Compiler Version 1.2	59.95
C Programming Language, Kernighan and Ritchie	...19.95
Shipping add \$3.00	
C.O.D. add \$3.00, foreign handling 15%	
California residents add 6%	
MasterCard and Visa accepted. (619) 755-4373	
Dealer inquiries invited.	

## DUGGER'S GROWING SYSTEMS

Post Office Box 305, Solana Beach, California 92075 (619) 755-4373

## The Premium: Micronix's Finger-Walking Keyboard

The Color Computer keyboard has been the subject of a great deal of criticism since it has been available. Many people hate the Chiclet-like keys and snap action, although some users do like it. When Radio Shack introduced its new 64K CoCo, it included a new keyboard with larger keys, but the new keyboard is just as controversial as the old with some people (myself included) saying that it's no big improvement over the old one. A number of companies have introduced full-travel keyboards for the CoCo, and several have been reviewed in *the Rainbow* before. One of these, the Professional Keyboard from Micronix, was reviewed in March 1983. Micronix has recently introduced a new keyboard called the Premium, which is an improved version of the Professional.

The Micronix Premium keyboard is available in two versions. One is used with the "old" Color Computer, which had a RAM size button on the top; the other is for the "new" CoCo, which has the nameplate centered over the keyboard, and also the TDP System 100 and the Color Computer 2. Each version is available for the same price, as opposed to some upgrade keyboards that require an adapter to work with the new CoCo and TDP-100. The Premium (and now the Professional as well) comes with a keyboard driver program called Versakey, which makes use of the four added function keys.

The unit that I tested was apparently an early model, and I got the manual for the earlier Professional keyboard. The installation procedure is apparently identical to that of the older model; I had no problem doing the job from the manual. Absolutely no alterations to the computer are needed, not even cutting down the center support post

(which some other keyboards require). In effect, all you do is unplug the old keyboard, plug in the new one and place it on the posts. One minor problem is that the holes may not line up exactly with the posts, but this is solved by holding the front of the case together firmly when you turn it over and then putting the two front screws in first. Seven photos (in the manual that I had) show you the exact procedure.

One thing that Micronix has improved over the earlier Professional is that all the normal CoCo keys are placed in the normal Radio Shack layout. The four function keys are located to the left of the space bar; the bar is now one key width off center, but if you are accustomed to the old CoCo keyboard you will have no problem as the new bar occupies the same width it did before and then some.

Unfortunately, the Premium keyboard has a number of serious shortcomings compared to other keyboards. The first thing you notice when you see the keyboard is that the keys are placed a bit too high, so that you see the key plungers under them. This detracts greatly from the general appearance of the computer. Another is that the letter and numeral keys are gray with white markings, rather than gray with black as on the CoCo keyboard. The white symbols are very hard to read and can actually slow down your typing if you are in the habit (as I am) of looking at the keys as you type. (I apologize to all the typing instructors out there, but I'd rather use a method that works than a "correct" technique that I never quite mastered—especially since I'm constantly switching between two computers on one side of the room and a typewriter on the other.)

The Premium keyboard does have an excellent feel. The ads say that it is an ALPS keyboard (ALPS makes the keyboards in the Model III, the Model 4 and the Commodore 64), but the unit I received was made by Oak, which is better known for cable TV converters and the ON TV pay service. It is, however, very much like an ALPS keyboard except that Micronix has wisely avoided the stampede toward "sculptured" keys in favor of the more normal stair-step layout. A problem with the Oak keys is a tendency for the space bar to come back up slowly after it is pressed; the bar doesn't actually stick, but it is difficult to type a string of spaces quickly.

The Versakey keyboard driver program, which is supplied with the Premium and Professional keyboards, works on 16K, 32K and 64K systems. It apparently doesn't require Extended Color BASIC (although I did not try it on the 8K Color BASIC), and it can be easily backed up and transferred to disk. Versakey lets you redefine any key combination to represent any desired string, so you can set up the keyboard to let you use single-key commands for BASIC statements. You also get a repeat feature, and the cursor is now a blinking black block instead of a multicolored one. The 64K version has a bug that causes the system to crash when you press the [Reset] button; on all size systems, you can't save your redefined key codes, despite the instructions in the manual.

Because of the Premium keyboard's minor problems, I would suggest that you look carefully at it and the other upgrade keyboards on the market before making your choice. It is not only usable but useful, and it will give good service reliably, but you may like another keyboard better.

(Micronix Systems Corp., 8147 Delmar, St. Louis, MO 63130, \$79.95)

— Ed Ellers

### Upcoming RAINBOWfests

**RAINBOWfest** — Long Beach

DATES: Feb. 17 — 19, 1984

HOTEL: Hyatt Regency, Long Beach

ROOMS: \$59 per night single/double

KEYNOTE: Bob Albrecht

Advance Ticket Deadline: Feb. 13, 1984

★ ★ ★

**RAINBOWfest** — New Brunswick, N.J.

DATES: March 30 — April 1

HOTEL: Hyatt Regency, New Brunswick

ROOMS: \$59 per night single/double

KEYNOTE: To Be Announced

Advance Ticket Deadline: March 23, 1984

★ ★ ★

**RAINBOWfest** — Chicago

DATES: June 22 — 24, 1984

HOTEL: Hyatt Regency, Woodfield

ROOMS: \$46 per night single/double

KEYNOTE: To Be Announced

Advance Ticket Deadline: June 18, 1984

# COLOR BASIC UNRAVELLED



## "Color BASIC 1.2 / Ext. BASIC 1.1 / Disk BASIC 1.1"

- \* FULLY COMMENTED - NO HOLES
- \* ALL FCBS, FDBs and FCCs defined.
- \* COMPLETE MEMORY MAP - no missing spaces, everything is defined.
- \* PROGRAMMING TRICKS EXPLAINED
- \* EASY TO UNDERSTAND
- \* MOST RECENT ROM VERSIONS

COLOR BASIC UNRAVELED	\$19.95
EXTENDED BASIC UNRAVELED	\$19.95 AVAILABLE 9/9/83
DISK BASIC UNRAVELED	\$19.95 AVAILABLE 9/23/83

All 3 for \$49.95

## COLOR BASIC UNRAVELED

Have you ever wondered how Color Basic does all of those wonderful tricks it does?

- \* How does it multiply & divide so fast?
- \* How can it paint the screen so fast?
- \* How does it know where to GOTO or GOSUB?
- \* How does it turn all of those graphic dots on and off?
- \* How does it get information on and off of that little diskette?

Now you can find out for yourself.

Color Basic is a set of three books that will provide you with a COMPLETE COMMENTED SOURCE LISTING OF TRS-80 COLOR, EXTENDED and DISK BASIC.

The listing will enable you to determine exactly how Basic works. An explanation of the Color Basic interpreter is included.

## The Facts

Learn how the hardware of the Color Computer works. The FACTS and Color Basic Unravalled comprise a complete machine language encyclopedia of the Color Computer.

The FACTS is a compendium of data to explain in detail the internal workings of the hardware of the Color Computer. It will explain how to use machine language to access the following:

- |                    |                            |
|--------------------|----------------------------|
| 1) Keyboard        | 5) Video display models    |
| 2) Joysticks       | 6) Change the display page |
| 3) Sound Generator | 7) Cassette routines       |
| 4) RS232 port      |                            |

Included will be a complete schematic and block diagram of the computer and complete technical information on the key integrated circuits in the computer—6809E microprocessor, 6847 video display generator, 6821 peripheral interface adapter and the 74LS783 synchronous address multiplexer (SAM).

The FACTS is specifically written to provide the information which is needed to write programs which fully utilize the capabilities of the computer. It is the most complete description of the Color Computer, providing more information than the Color Computer Service Manual.

\$16.95



We accept VISA and MASTERCARD.  
All prices U.S. Funds. No C.O.D. Orders.  
Add 5% for shipping. \$2.00 min.  
Washington residents add 7.8% sales tax.

BUSINESS OFFICE HOURS  
MONDAY - FRIDAY  
8:30 - 4:30 P.D.T.  
(206) 581-6938



## Banners Banners Banners — A Colorful, Large-Character Generator For The CGP-115

Programs written to exploit the capabilities of the CGP-115 plotter are so few there is a distinct temptation to overrate those that exist. Firms like Custom Software Engineering have made the deliberate decision not to adapt their *Graphic Screen Print Routine* for the little printer-plotter, for reasons sound enough in their eyes; and this decision has had the merit of opening the field for smaller and hungrier firms.

All-American Ultralight Industries seem to be a very small firm (their documentation is run off on a copying machine from a typewritten original, for one indication), but they have already scored one remarkable success with *CPP (Color Picture Plotter)*, for four-color screen dumps of PMODE 3 screens. *Banners Banners Banners* again addresses the CGP-115 market, this time to generate banners of up to 250 characters in any color or all four, in 39 sizes from 25 (about 1/3 the paper width) to 63 (almost the whole width). Its method is to redraw the characters a selected number of times while incrementing the X and Y axis by a selected amount between repetitions. Since that sentence may not convey very much real information, here is an example to

clarify things — 15 repetitions, red, size 25, X increment 1, Y increment 2:



The manual, two sides of a single sheet, tells you all you need to know with perfect clarity. Its most refreshing moment comes early, when it advises you to run the program first and then read the instructions — and follows this advice with instructions on how to run the program.

The author, L.W. Beears, is undoubtedly one of those programmers who have been attracted to CoCo from the SS-50 bus by the possibility of actually making a living programming for the larger customer-base. They are a remarkably skillful lot, and a welcome addition to our resources, but you can tell them fairly easily by certain distinguishing traits. Mr. Beears uses Sugar Software's *Auto-Run* module which employs many ROM calls, but his own machine-code, in *CPP*, employs none; Rich Parry, who gave us *The Composer*, seems to think in 6800 code, as may be seen from the sound effects routine he included in that package. These are not faults, mind you.

*Banners Banners Banners* was written entirely in Extended Color BASIC, for ease in altering input parameters. No, that does not make the program run intolerably slowly; the CGP-115 would take the same time if written to in C, PL/9 or 6809 machine code. But it does make the misspellings in the screen display a lot easier to correct ("repetitions" is spelled "repitions", for one example).

I would like to report that this is the ultimate banner generator for this printer. It is not. The fault is not Mr. Beears', however, except that he has made use of the CGP's built-in character set, which produces characters not very attractive at best. What he now needs to do is supplement this program with one which will furnish custom character sets, perhaps several of them, for selection by the user.

(All-American Ultralight Industries, 1144 Kingston Lane, Ventura, CA 93001, \$9.95 tape)

—R.W. Odlin

Aurora  
Software

49 BROOKLAND AVE.  
AURORA, ONTARIO  
CANADA L4G 2H6

### FAMILY GAMES

FOR 16K AND 32K COLOR COMPUTER

**STOCKBROKER** — Up to 6 players can play the stock market. For 16K or 32K ECB. The 32K is in High-Res Graphics.

**CRIBBAGE** — For 2 or 4 players. In High-Res Graphics! (for 32K).

**BATTLE** — Will you get bombed before you can find all the ships? An extremely entertaining game for the family.

**COLORMIND** — Up to 4 players challenge for hidden colors.

**REMREM** — Challenge your friends. Who can remember the longest color sequence?

**CONCEN** — Challenge the computer or a friend to a good ol' game of concentration.

ALL GAMES only \$20.00 or ANY TWO for \$35.00

ALSO FROM Aurora Software:

**MR. COPY** — A quality copier written in M.L. that will make backup tape copies. MR. COPY is capable of making up to 99 copies in one loading! \$25.00

**ROMDISK** — If you have a modified 32K C.C. machine ROMDISK will allow you to load your R.S. Rom Packs from a disk! \$20.00



**Mission: DESTROY**

Agent File #87

Your mission, should you choose to accept it, is to destroy the 18 warhead missile being engineered by Soviet scientists. The text screens and high-res graphics screens bring you the ultimate espionage adventure. Req. 32K extended basic \$17.95

**TOP SECRET**

Creations Unlimited  
28 Tilton Lane  
Andover, MA 01810



# MORETON BAY SOFTWARE

## DOUBLE DRIVER

The BEST monitor driver available, unlike some monitor drivers the Double Driver provides TRUE monochrome and color composite output. Audio Output. Solderless installation. \$24.95



## THE COCO SWITCHER

Hook up three peripherals to your RS-232 jack. Connect your modem, printer or any RS-232 device to the CoCo switcher. Select among your peripherals by turning a switch. LED power on light.

Dimensions 2 1/2" (64 mm) x 4" (102mm) x 5 7/8" (150 mm) \$39.95



## 64K UPGRADES

Instantly access 64K via M/L. Totally solderless kit to upgrade E Boards. Kit includes eight 4164 prime chips and chips U29 and U11 already soldered. E Board Kit \$69.95

Color Computer II kit requires soldering. \$69.95



## MORETON BAY SOFTWARE

A Division of Moreton Bay Laboratory



316 CASTILLO STREET  
SANTA BARBARA,  
CALIFORNIA 93101  
(805) 962-3127

## MERCEDES

### MERCEDES

Write programs with mnemonic labels  
Automatic generation of data lines from Machine Code  
Automatic line numbering  
Merge Basic Lines  
Split Basic Lines  
Full Screen Edit  
Insert  
Delete  
Overtyping  
More!



\*A M/L utility for the BASIC programmer. Automatic conversion of M/L routines to data statements, automatic line numbering, write MNEMONIC line labels and compile it to a running program. Requirements: MERCEDES 16K, TOOLKIT 16K. MERCEDES alone \$19.95. MERCEDES with TOOLKIT \$32.95

\*COCO WRITER II - an excellent word processor at an affordable price. characters per line: **32, 51, 64, 85**, justify right, left, center, insert, delete, move blocks, MENU driven printing, tabs, etc. \$34.95 Tape 16K EXB  
Disk Version - menu driven, tape and diskfile management system included \*\$44.95 32K EXB

\*With either program you get a FREE copy of SPOOL 64 which allows you to use the upper 32K of a 64K machine.

## GRAPHICOM

The Ultimate Graphic Utility

You must see this program to believe it! Create pictures and text on the same screen. Now you can create pictures as good as any graphic you have seen on the color computer. Write graphic adventures or educational programs. Requires 64K EXB, Disk Drive and Joy Sticks \$29.95

## Ordering Information

Add \$2.00 shipping and handling per order. We ship within 24 hours on receipt of order. Blue Label Service available. California residents add 6% sales tax.

## Time Patrol—A Fun Way To Spend Some Time

*Time Patrol*, by Computerware, is a great 32K graphics game for all space shooter fans. In this intergalactic Adventure, your ship is at the center of a moving cosmic screen display. You are attacked by swarms of the enemy and must defend yourself with twin rapid fire cannons. The enemy first appears in biplanes with a dirigible as a mother ship. When you manage to shoot the mother ship, you are advanced to another level with a different style of enemy craft attacking and a more advanced form of mother ship to destroy.

The game has both a practice mode, with 255 planes available, and a play mode, with four planes available and extras awarded every time you advance to the next level. In the play mode, the top 10 high scores are displayed between games. This assures bragging rights for all the sharpshooters in the family.

Graphics and sound in this game are well done. The graphics are quite detailed and smoothly animated for good play value. False or aliased colors are used and you may press the reset button until you get the color (red or blue) that you prefer. The sound effects used are not spectacular, but they work well with this game. The gun sounds, in particular, are quite effective in conveying the effect of a heavy rapid fire weapon. One joystick is required and joystick response is quite good using the standard Radio Shack joystick.

The game is supplied on an autoloading tape in Computerware's attractive hanging package. The documentation describes how to load the game by typing *CLOADM*, the basics of how to play the game, one good hint, and instructions on how to get a damaged tape repaired by Computerware. Since this is a copy-protected tape, this is a necessary option even at the price of \$5 for tape and \$8 for disks.

In summary, I feel this is a well-done game with good graphics and worth the time it takes to load the tape.

(Computerware, Box 668, Encinitas, CA 92024, \$26.95, 32K tape; \$29.95, 32K disk)

—Charles Bream

## Great Fun For Beginning Adventurers

The first thing that really impressed me with Owl's Nest's *Adventure Starter Package* was the documentation. While only two pages long, these instructions to the beginning Adventurer are excellent. The explicit information not only goes into how to load the programs, but provides detailed hints and ideas about the Adventure games. If the info sheet is not enough, the first Adventure, *MYHOUSE*, includes a "HELP" command that encourages you to try something you may not have done.

*MYHOUSE* has you enter a house, find a gold coin, and escape from the house. As simple as this sounds, it actually is an interesting game. You are required to get into the house and then roam through it, trying to find the combination to the hidden safe. Now, I do not claim to be a fantastic Adventure player; suffice it to say that it took me twice as long to finish the Adventure (about a half-hour), than my children. And it certainly did not help when my youngest son thought it was really funny that I was trying the wrong safe combination. They felt the Adventure was a snap and really enjoyed it. I enjoyed it, too.

The directions for loading require you to *PCLEAR0 (POKE 25,6:NEW)* but did not mention that you should also remove the disk controller pack.

When you have mastered *MYHOUSE*, Owl's Nest Software includes a second program, *PIRATE ADVENTURE*. This is a little more difficult to complete and I found that it is quite easy to lose by swimming in the ocean and being eaten by a great white shark (not a nice way to go) or by falling into a pit with no hope of escape (better than being eaten by a shark). *PIRATE ADVENTURE* has you find the treasure and does become more complicated by requiring you to do things like finding the oars to the rowboat before being able to row.

Both programs do a nice job of developing an interest in Adventure game playing and were enjoyable. Now, excuse me while I try to swim away from that shark again.

(Owl's Nest Software, P.O. Box 579, Ooltewah, TN 37363, \$17.95)

—Michael Garozzo



### COMPUSETTE.

## NEVER UNDERSOLD

"We'll Meet or Beat ANY Comparable Offers!!"



AFOA  
PE 611

Diskettes		Qty.	Retail	Sale	Cassettes			
40-Track	10 pak		\$3 <sup>99</sup>	\$1 <sup>99</sup> ea.	C-5	99c	65c	55c
Single Sided	20 pak		\$3 <sup>69</sup>	\$1 <sup>99</sup> ea.	C-10	\$1 <sup>29</sup>	69c	59c
Double Density	50 pak		\$2 <sup>99</sup>	\$1 <sup>99</sup> ea.	C-15	\$1 <sup>49</sup>	75c	65c
With Hub Rings	100 pak		\$2 <sup>49</sup>	\$1 <sup>99</sup> ea.	C-20	\$1 <sup>69</sup>	79c	69c
	10 pakcase		\$4 <sup>99</sup>	\$3 <sup>50</sup> ea.	Hard Box	49c	26c	21c

—UPS Shipping (48 States) \$3<sup>00</sup> Per Pack—

## Micro-80™ INC.

2665 Busby Rural Road  
Oak Harbor, Wash., 98227

  

## IMMEDIATE SHIPMENT

# 1-(206)-675-6143

# GET WITH THE PROGRAM

## RAINBOW SCREEN MACHINE

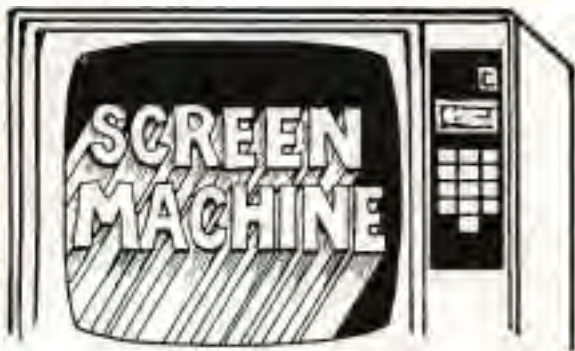

The Rolls Royce of graphics/text screen enhancers — more features than all others combined!

- Add these features to your computer/program: ML extension of Basic loads on top of 16, 32, or 64K machines to enable easy mixture of hi-res graphics and text in your programs. Dense text or large lettering for children, visually impaired or VCR title screens with no programming!
- User definable 224 character set featuring lower case descenders, Greek, cars, tanks, planes, etc., completely interfaced with all keys, commands, and PMODES. 12 sizes (most colored) from 16x8 to 64x24.
- 2 distinct character sets automatically switch for sharpest lettering featuring underline, subscript, superscript, reverse video, top and bottom scroll protect, double width, colored characters in PMODE 4, and help screen.
- Includes demo program, character generator program and manual. 16K Ext. Basic required - 32K recommended, \$29.95 Tape, \$32.95 Disk.
- Super Screen Machine adds SMOOTH Scroll, Key Click, Break Disable, Screen Dump command and more. \$44.95 Cass - \$47.95 Disk.

2<sup>7</sup> 16<sup>3</sup>  
7FFF

AE5 .00  
ASSEMBLER  
MATH

At last! A hi-res *graphics* tutorial that teaches the fundamental concepts of binary and hexadecimal *math* so essential to assembly language programming on the Co Co.

Sections include:

- Decimal to binary
- Binary to decimal
- Binary addition
- Binary subtraction
- Binary to hexadecimal
- Hexadecimal to decimal
- Decimal to hexadecimal

Includes demo and extensive manual

32K Extended Basic — \$24.95 Cass - \$27.95 Disk



## CONQUEST OF KZIRGLA & SCEPTER OF KZIRGLA

Dungeons, wizards, treasure chests, hidden trap doors and more. If you enjoy challenge and complexity, these adventure games are for you. Featuring real-time graphics with arcade sound for your color computer. "Scepter" requires 16K Extended Basic, \$16.95 Cass - \$19.95 Disk. Hi-res sequel "Conquest" 16K Extended Basic Cass \$21.95; 32K Disk \$24.95.

Discover the Rainbow in your Color Computer!



**RAINBOW CONNECTION SOFTWARE**

**RAINBOW CONNECTION SOFTWARE**

3514 6th Place NW, Suite D  
Rochester, MN 55901  
507-288-4424

ITEM	CASSETTE/DISK	PRICE	NAME
			ADDRESS
			CITY
			STATE ZIP
		Sub Total	
		Shipping \$2.00	
		Minnesota residents add 6% Sales Tax	
#			
Exp			
		TOTAL	

Personal checks welcome - no delay.  
Dealer inquiries invited.  
Send SASE for catalog.

Not affiliated with THE RAINBOW



## Euchre — An Entertaining Card Game Of Tricks

Card games have always been a favorite of mine, especially if they require skill as well as a little luck to win. If you win then you can compliment yourself on your high degree of proficiency, and if you lose, well, you can always blame lady luck for having turned her back to you.

Having written the pro-gambler oriented program *Blackjack Royale* for the CoCo, I have a pretty good idea just how difficult and time consuming it is to develop a program that accurately simulates a simple card game. For the author it usually is a labor of love rather than a profit making vehicle, and for the end user it is a dream come true that someone took the time to do it. Many times while reviewing this program I had flashbacks to the time I was developing and debugging *Blackjack Royale* — the ever-perking coffee pot, overflowing ashtrays, gallons of midnight oil and the complaints from others that I was spending too much time hacking away! It is hard not to feel a kinship towards the author of this program I am reviewing.

*Euchre* is a perfect example of a card game that can be converted to run on a computer to entertain and challenge. During the late 19th and early 20th century, Euchre (pronounced "You-ker") was the most popular card game in the United States because of its simplicity and fast play. Since most variations of the game require at least four players, it lends itself well to family play, a fact which must have contributed to its widespread popularity. Many versions exist that were transplanted from England, France, Ireland

and Germany with this adaptation most closely resembling the version called "Hasenpfeffer" developed by the Pennsylvania Dutch, although it does not exactly match any variation listed in the rule book of games "according to Hoyle." The game of Euchre can best be described as a game of war with many subtleties and fine points to make it more interesting and challenging.

This 32K version is written in BASIC using PMODE 3 graphics and is available on cassette or disk. The program is not copy protected; in fact, the manual advises the user to make backup copies just in case the glitch fairy steps on your master copy. (My word, not theirs!)

After loading and running the program you are prompted to press the reset button until the letters on the screen are switched from blue to red at which time you are ready to play. There are four players grouped in two teams of two, although only one human player can participate. The other three positions, including that of your partner, are played by the computer. You may select to play without a partner, in which case you are pitted against the opposing team of two players.

The deck is a standard poker deck using only the 9, 10, ace, king, queen and jack cards of all four suits, for a total of 24 cards. Each player is dealt five cards with only your hand face up. The top card from the remaining deck is placed face up as a proposed trump suit that players have a choice of accepting or rejecting. The players, in rotation, place one card from their hand in the center after establishing the suit for that round of play. The team with the highest card value gets the "trick" and the point for that round of play. After five rounds of play the team with the highest number of tricks gets the point for that hand. New rounds of play are completed until one team scores a total of 10 and is declared the winner.

The graphics are quite good with the card faces very similar in design to the video card gambling machines found in Nevada casinos. Sound effects are used very sparingly, but with good effect, as a beep is heard when each card is dealt or played. This seems sufficient without being distracting to the player.

The documentation is poor in both content and quality, consisting of four pages faintly painted on one side only, with a line width of about 50 characters. A description of the rules and play of the game is given in detail using terms such as left and right Bauer-Jack, trump suit and trick. Inexperienced card players may be unfamiliar with these terms and may have to refer to a book on card games to comprehend them as they are essential in understanding the hierarchy of card values.

In two ways *Euchre* could be considered a "classic." It is an excellent, well-written and entertaining program that plays well and shows what can be done with graphic commands, well-designed screen formatting and tightly-structured programming. In quite another sense it is a classic example of a good program being weakened by poor documentation, which assumes prior knowledge of the game.

All things considered, however, I would recommend *Euchre* to anyone who likes to spend cold winter nights playing card games against the computer. Card game addicts will find *Euchre* to be a welcome addition to their program library.

(Chroma Systems Group, P.O. Box 366, Dayton, Ohio, 32K ECB tape \$19.93)

—J. Michael Nowicki

### CY-BURNET-ICS

Specializing In Educational Software  
For TRS-80 COLOR COMPUTER

**GRAPHIC ALPHABET**—for preschool through first grade designed to be used individually or with large groups; large colorful block upper case letters displayed on the screen; auto run; menu consists of A, B, C's with voice, A, B, C's no voice, Next Letter, Random Alphabet, Random Next Letter, and Missing Letter; Quit Option returns to menu at any time; computer will advance only after student presses appropriate key representing missing letter; musical tones provided.

MINIMUM REQUIREMENTS 16K EXTENDED BASIC ..... \$24.95  
See review of this program in Dec. '83 *Rainbow*, page 258.

**SUBTRACTION DRILL**—for kindergarten through fourth grade designed to be used individually or with large groups; auto run and menu driven 10 levels: 1) sequential facts 0-0 through 5-5, 2) sequential facts 6-6 through 10-10, 3) random facts 0-0 through 5-5, 4) random facts 6-6 through 10-10, 5) minuend to 99 with no regrouping, 6) random facts 10 to 18, 7) minuend to 999 with no regrouping, 8) minuend to 99 with borrowing A 10 (carry aide tutor provided), 9) minuend to 999 with borrowing A 10, and 10) minuend to 999 with borrowing 10's and 100's. Large colorful numerals presented in vertical columns with right to left progression. Computer displays correct answer after 2 misses. Erase and quit options. Rewards provided.

MINIMUM REQUIREMENTS 32K EXTENDED BASIC ..... \$24.95

ALSO AVAILABLE CASSETTE

CLOCK ARITHMETIC/TUTOR 32KEB ..... 24.95

NUMBER READINESS DRILL 32KEB ..... 19.95

NUMBER & COLOR WORD DRILL 32KEB ..... 19.95

NUMBERS BEFORE/BETWEEN/AFTER 16KEB ..... 24.95

ADDITION DRILL (7 LEVELS) 16KEB ..... 24.95

BEAT COMPUTER MULTIPLICATION AND

MULTIPLICATION TABLES DRILL 16KEB... Both for .... 19.95

NEW PRIMARY NUMBER SKILLS DRILL 16KEB ..... 24.95

• See our Ad in Sept., Oct., or Nov. *Rainbow* for description of CLOCK,

BEAT COMPUTER, AND MULTIPLICATION TABLES DRILL.

• All programs developed by educators and field tested.

• Add \$1.00 per cassette for shipping and handling. Tennessee residents

add 6% sales tax. Send self addressed stamped envelope for free catalog.

Mail CHECK or MONEY ORDER to:

**CY-BURNET-ICS**

5705 Chesswood Drive, Knoxville, TN 37912

Phone 615-688-4865

## Pager/64K Boot— Two More Utilities For CoCo

Skyline Software has come up with two utility programs that are for 64K CoCo owners only. If you don't have 64K, read this review anyway; it will give you a sampling of just what you are missing!

The first program, *Pager*, makes use of the 6809's ability to select separate 32K banks or pages of memory. To load, first clear some string space and reserve a spot in upper memory for the program. The normal *CLOADM* and *EXEC* commands start the program. At this point you are presented with a menu of five options to choose from and also what page you have selected, Page 0 or Page 1. The first option duplicates the menu and switches you to Page 1 or vice versa if you are already in Page 1. Option two allows you to copy a BASIC program from the present page to the other page. Number three will copy a specified area of RAM from the present page to the other, you supply hex start and end addresses for this step. Option four will swap the entire contents of each page with each other from 0000 up to the area you protected before loading. Finally, choice five lets

you get back to BASIC. Anytime you want to jump back into the program just *EXEC* and you will be back in the menu mode.

Besides demonstrating some unique features of the 6809 CPU, you may be asking yourself, "can this program do anything useful?" Probably the most common usage will be in modifying or editing an existing BASIC program. Your original program can reside in Page 0 and the modified one in Page 1. This way any changes in program operation can be checked just by changing between pages and comparing their operation with one another. If your modified program crashes you have a "backup" on Page 0 to save you. Or, let's say you are ready to *CSAVE* your favorite many line program; just copy it into both pages and *CSAVE* to tape. If you cannot *CLOAD* due to a bad tape or whatever, you still have a "backup" on Page 1 to try again with.

The second program supplied is *64K Boot*. This enables you to copy the material in ROM to RAM and puts the CoCo into the 64K mode. The main advantage in having ROM in RAM is the ability to modify BASIC. This requires a knowledge of the BASIC memory map so you can poke in various changes such as Baud rate or even the stepping rate of a disk drive.

The documentation is brief but more than enough to get started. Also included is the assembler source code for both programs—a treat for ML buffs.

(Skyline Marketing Corp., 4510 W. Irving Park Rd., Chicago, IL 60641, cassette \$19.95)

—Ron Hansen



# AVAILABLE NOW DRAGON USER

To make the most of your new Dragon microcomputer from Dragon-Tano, you need *Dragon User* — the international, independent magazine for Dragon owners.

- Each issue of *Dragon User* contains:
- reviews of the latest software
  - programming advice for beginners
  - hardware projects

- program listings covering games and utilities
- reviews of Dragon peripherals and add-ons
- technical advisory service
- programming articles for users

The Dragon microcomputer was launched in the UK last year. Since then we have developed a knowledge and mastery of the machine's abilities. You can benefit from our experience by subscribing to *Dragon User*, which is expanding its coverage to include all US developments.

To make sure that you receive a copy of *Dragon User* regularly, subscribe direct to us. This costs only \$29.95 for 12 issues airspeeded to you — or take advantage of our special offer to long-term subscribers. Individual copies of the magazine can be obtained from your Dragon dealer.

**Subscription order form.** Receive a free book and save money by taking out a long-term subscription — a two-year subscription saves 10%, a three-year subscription saves 20%. In addition, long-term subscribers will receive a free copy of either  *The Working Dragon* or  *Dragon Games Master*. Please send a check, made payable to *Dragon User*, with this form. Start my subscription from the following issue:

Name \_\_\_\_\_

Address \_\_\_\_\_

Signed \_\_\_\_\_

Date \_\_\_\_\_

Subscription rates US and Canada airspeeded  US\$29.95 for 12 issues/1 year  
 US\$53.90 for 24 issues  US\$71.90 for 36 issues. Send this form to  
*Dragon User*, % Business Press International, 205 E. 42nd St., New York, NY 10017.

## The Complete Personal Accountant — An Excellent Financial Package

The *Complete Personal Accountant* is an excellent piece of software that has been developed for the Color Computer. This package seems to be able to produce all the information that an individual would need to know about his financial health. I'm sure that would apply to a small business also. To use *CPA*, you will need a Color Computer with Extended BASIC and either one disk drive or a cassette recorder. There are two versions, 16K and 32K. (If you purchase the 16K version for disk, you must store some data on cassette because of memory constraints.) It is not necessary to have a printer but, I personally wouldn't want to use a program of this quality without one.

I'm not going to be able to cover all the bells and whistles of this package, but I will cover the main features and describe the function of each of *CPA*'s ten programs. I am reviewing the second edition of the disk version. It comes packaged in a three ring binder with 153 pages of excellent documentation. At first I got a little irritated at the author

because I felt the documentation had too much repetition, but then I realized it was written this way so that once you have initially set up your files you can utilize any of *CPA*'s ten programs without having to backtrack through the manual to figure out what you are doing. The manual is broken down into three sections and at the end of each of these sections are some examples of what your reports should look like. The only criticism I have of the documentation is that the three ring binder has 1/2" rings and this makes it quite difficult to flip the pages without tearing.

With *CPA* you can: record checks and deposits; balance your checkbook; record savings, loans and investments; print checks; budget your spending and savings; graph financial information; keep track of bills and appointments; and print a mailing list. In order to do all these things, there are ten different programs that you can call from a menu. Many of the programs work together to give you the information you want, but I am going to try to describe each one separately for the purpose of this review.

**Chart Of Accounts** — This program allows you to establish your own unique set of accounts (up to 99). Each account is assigned a number from 1 to 99 in the following manner: Asset Accounts (1-20), Liability Accounts (21-45), Equity Accounts (46-50), Income Accounts (51-60), and Expense Accounts (61-99). An account can then have up to nine sub-categories. For instance, if you had an expense account set up for medical, you could then set up subcategories for each doctor, the hospital, drugs, etc. The only limitation is that the total number of accounts plus subcategories cannot exceed 241. Each account name can be any combination of up to thirty letters and numbers. Each subcategory can be up to fifteen characters long. The package comes with 66 accounts already named and numbered for you. You can add to or change any of these if you like. Adding, changing, or deleting an account is a breeze and as long as you use the save option every time you make changes you will have a current chart of accounts.

**Checkbook Maintenance** — This program will keep a record of all your checks, deposits, service charges, and payments on any of the accounts set up in your Chart of Accounts. It will assist you in keeping track of tax deductible items and help balance your checkbook. In addition to keeping track of individual checks you have written, you can use *CPA* to break a check down into as many as 25 separate accounts. Let's say, for example, you use a credit card to purchase gasoline, some clothes, concert tickets, and new software or hardware for your Color Computer. If you pay off this bill with one check, you could assign portions of the check to the appropriate accounts. Balancing your checkbook is easy with this program. Of course, if it doesn't balance you will have to put forth a little effort to find your error, but it should be easy if you print out the checkbook and compare to the bank's statement. You can print a copy of your checkbook at any time for any month. The printout will give you the totals for deposits, checks written, and tax deductible items. If you want, *CPA* will even print checks for you. I must say though that I wasn't impressed with this feature. I printed out some checks on regular printer paper and it used practically the entire eight-inch width for the check. It would have been nice if the documentation gave some hints on how to customize this for your own checks or at least information on where the checks the program was designed for could be purchased. One other thing that might cause you a problem is that the description of each check you enter is limited to

• **RADIO SHACK™ COLOR COMPUTER**  
**ADVANCED MATH PROGRAMS**  
for  
**ENGINEERS • PHYSICISTS • STUDENTS**

**FUNCTION GRAPHING MODULE 16K EXT-\$19.95**

- \* HIGH RESOLUTION GRAPHS
- \* GRAPH ANY FUNCTION — 4 AT ONCE
- \* PARAMETERS EASY TO CHANGE
- \* AUTO-SCALING OPTIMIZES GRAPH SIZE
- \* COMPUTE FUNCTION VALUES & ZEROS
- \* INTERSECTION OF FUNCTIONS
- \* COMPLETE MANUAL — PROGRAM ON TAPE

**CALCULUS MATH MODULE 32K EXT-\$37.95**

- \* INCLUDES THE GRAPHING MODULE ABOVE
- \* LOAD UP 9 FUNCTIONS AT ONCE
- \* FIND AND COMPUTE MAXIMA & MINIMA
- \* NUMERIC INTEGRATION & DIFFERENTIATION
- \* COMPOSITE AREAS
- \* HANDLES PIECEWISE CONTINUOUS FUNCTIONS
- \* HARD COPIES OF DATA AND/OR GRAPH
- \* COMPLETE MANUAL — ON TAPE OR DISK



**CALCSOFT**  
P.O. BOX 401  
ST. ANN, MO 63074



**SEND CHECK OR MONEY ORDER**  
Add \$2.00 for shipping

## **DECISION MAKER™**

IF YOU HAVE EVER HAD TROUBLE  
MAKING UP YOUR MIND, THEN THIS  
PROGRAM IS FOR YOU!!

- \* A step by step interactive program to help you solve your problems
- \* Designed to use standard analytic techniques
- \* Works with any problem
- \* A valuable tool for anyone
- \* Requires 32K & Ext. BASIC



\* Now, only.....\$ 24.95

## **BIO-PSYCHOMETER™**

INVESTIGATE THE HIDDEN REALMS  
OF THE HUMAN MIND!!

- \* Authentic Bio-feedback device and software
- \* Machine Language, high speed graphics
- \* Includes:  
Bio-feedback graphing,  
Stress Reduction, and  
Memory Improvement modes
- \* Very sensitive hardware for optimum results
- \* Requires 32K & Ext. BASIC
- \* With manual, only....\$ 39.95

## **COLORFORTH™ Version 2.0**

### **FORTH LANGUAGE COMPILER**

- \* The original COLORFORTH Compiler is now even better
- \* COLORFORTH V2.0 can access ALL available RAM - 16K through 64K
- \* COLORFORTH is at least 10 to 25 times faster than BASIC
- \* 50 words are included in addition to the standard figFORTH vocabulary (commands)
- \* This package includes BOTH cassette and R/S DOS versions PLUS a resident figEDITOR, and 75 page manual
- \* Rated "BEST BUY" of Color Computer Forths reviewed by COLOR COMPUTER MAGAZINE, July 1983. (Version 2.0 is an even better buy)
- \* There IS life after BASIC, with COLORFORTH
- \* All of the above, for only.....\$ 49.95

DEALER and AUTHOR INQUIRES INVITED

Please add \$2.50 shipping in U.S.

Texas residents add 5%

Foreign orders must be in U.S. funds drawn on U.S. banks, or Mastercard and VISA

**ARMADILLO INT'L SOFTWARE**

P.O. BOX 7661  
AUSTIN, TEXAS 78712



PHONE (512)835-1088

just 15 characters. This means that when you want to write a check the payee's name must be limited to this same 15 characters.

**Checkbook Search** — This program will allow you to search your checkbook by check number, deposit number, description, date, or account number. For example, you could get a printout of all the checks you wrote for food during the year. There is also a browse option which will print the entire checkbook on the screen or printer.

**Detail Budget Analysis** — This program allows you to create a budget and compare your actual spending patterns to your budget. At any time you can add, change, or delete a budget record. You also have the option of searching through your budget file forward or backward sequentially, or look for a particular item with the search option. You have the ability to analyze your budget to your heart's content. If you want you can produce a report of all the checks you wrote against each budget account. This report can be sorted by account, subcategory, check number, date of check, amount of check or the payee.

**Summary Budget Analysis** — This program will print a summary of your budget so you can tell at a quick glance how you are doing compared to your budgeted amounts. This report is actually a summary of the Detail Budget Analysis.

**Net Worth/Income Expense** — This program will keep track of all your finances. You can print a balance sheet that shows your assets, liabilities, and net worth. You can also print an income/expense statement. A lot of the information for these statements comes from the entries you make in

your checkbook. There may be some things though that you do not process through your regular checking account such as the software or hardware you purchase for your computer that you don't want your spouse to find out about. These items can be entered into the file with a maintenance option. You can enter information such as the outstanding mortgage on your home, etc. When you finally get all the necessary data entered, you can print out a balance sheet to income/expense statement that looks just as impressive as the ones you see in corporate annual reports, only yours probably won't have as many trailing zeroes as theirs.

**Payments Calendar** — This program allows you to enter four pieces of information about those periodic bills you have to pay. The information is: bill name (or payee), amount of bill, month due, and the date due. If the bill is due every month then you can enter a special code and it will be included in the calendar every month. Once you have all this information entered you can get a printout showing when each of your bills are due during the month, how much they are for, and to whom they are to be paid.

**Appointments Calendar** — This calendar is quite similar to the payments calendar. For this one you enter three pieces of information: appointment month, appointment day, and appointment information (up to 24 characters). You then have the option of getting a printout of a particular month's appointments or you can specify to have the printout list those appointments between any two days you select.

**Mailing List** — This program will allow you to establish a mailing list and then print out the addresses on envelopes to mailing labels. The documentation doesn't say how many addresses you can store. This isn't as fancy as some of the mailing list programs on the market, but it will meet the needs of most users. Once the addresses are loaded you have the option of changing or deleting the addresses, and of course you can always add addresses. If you are looking for a particular address you can search by account number, addressee, address, city, state, or ZIP code. In regard to printing the addresses, you must either print all addresses or you can select one address at a time to print out. The program is set up to print single width labels.

**Color Graph** — This program allows you to print graphs of any of your financial records on the screen. The graphs are quite impressive and will allow you yet another method of analyzing your financial records. If you are really ambitious you may be able to incorporate one of the screen print programs to this one to get a print out of the graphs on your printer.

As you can tell, I'm quite high on *CPA*. It is an easy program to initially set up and use. The documentation is written in such a manner that if you only use the program once a month, you don't have to read the entire manual to figure out what to do to get the information you want. You just turn to that section of the manual and follow the instructions. Although I did mention a few things I didn't like about this program, they are primarily trade-offs the author had to make because of memory limitations, etc. I certainly would recommend this program to anyone with a need in this area.

(Programmer's Institute, P.O. Box 3470, Dept. R, Chapel Hill, NC 27514, \$79.95 disk, \$74.95 cassette)

—Michael K. Hunt

# FORMAKER

**CREATES THESE FORMS**

<b>Invoice</b>	<b>Overdue Notice</b>
<b>Letter</b>	<b>Receipt</b>
<b>Purchase Order</b>	<b>Job Quote</b>
<b>Mail Order</b>	<b>Order Confirmation</b>
<b>Payment Record</b>	

and stores all the information on disk or tape for easy retrieval later. Figure list, net, discount, subtotals, freight, tax, etc.  
Extremely user friendly.

32K Disk **\$29.00** (Freight Included)

**Easily customize it with your name, address, credit card #, tax rate & number and more.**

## Challenger Software

1729 Albemarle Rd.  
Clearwater, FL 33546  
or call **(813) 531-7654**

Call Between 9 am - 3 pm EST



*We'll mail you more information and a sample invoice.*





# LOOKING FOR A GOOD TIME?

Have a good time with our fantastic subscription software! *For as little as 46 cents* a program you can enjoy great games like **FROGJUMP, FRENZY, CATERPILLAR CAVE, SHOOTIN GALLERY,** and great adventures. Use powerful home management programs such as **BUDGET, STOCK MARKET, BARTENDER, TINY CALC,** and **COST OF LIVING.** Also, enjoy the use of powerful programming utilities such as **COCO MONITOR, GRAPHIC SCREEN PRINT, RAM TEST, HIGH RESOLUTION TEXT,** and **SINGLE DISK COPY.** Increase your knowledge with educational programs such as **BASIC SPEED UP TUTORIAL, FLASH CARD, TRIGONOMETRY TUTOR,** and our **8 PART SERIES ON MACHINE LANGUAGE.**

\* Many programs use machine language! \*\*



Every month you will receive a cassette tape with 10 ready to run documented programs.

16K Extended Required



ORDERS SENT SAME DAY!  
FIRST CLASS SHIPPING!

Back Issues Available from  
July, 1982.

Call or write for our free catalog.

Dealer Inquiries Invited.

## PRICES

1 YR (12 ISSUES) .	\$55.00
6 MO (6 ISSUES) .	\$30.00
SINGLE COPIES .	\$ 6.00

MICHIGAN RESIDENTS ADD 4% TO ORDER

OVERSEAS ADD \$10.00 TO SUBSCRIPTION  
AND \$1.00 TO SINGLE COPIES.

PERSONAL CHECKS  
WELCOMED!



616 396-7577  
T & D SOFTWARE  
P.O. BOX 256-C  
HOLLAND, MI 49423

## Mt. Doom — A Good Disk Based Adventure

Adventure games are nothing new on the CoCo software scene. In fact, the first program I bought for my CoCo was just such a game. Since then, CoCo has expanded greatly, both in the hardware and software departments. With 32 or 64K, and a disk drive, much more sophisticated software is possible. Fortunately for us, the CoCo software vendors have seen fit to take advantage of these increased capabilities. This applies not only to games, but to the more serious applications as well.

*Journey To Mt. Doom* is a 32K disk-based graphics Adventure. The program itself is written in BASIC with machine language subroutines. The disk contains the graphics for the various locations, which are loaded directly into graphics memory as you move from one location to another. Although this process slows the game down to a small degree, it is much faster than having to draw the graphics on the screen each time.

The object of the game is to prevent the "Necromancer" from waging war on the earth. To do this, you must first find the "magic ring," then make your way to Mt. Doom and destroy the ring, and finally return to your starting location. Naturally, there are many obstacles along the way, as well as some treasures to be found. Your score, if you survive, is based upon whether or not the ring is destroyed, and upon the amount of treasure you can bring back with you.

Playing the game is very easy. By using one- or two-word commands, you tell it what it is that you want to do. For

example, you can TAKE an object, LOOK at your surroundings, get an INVENTORY of what you are carrying, and move NORTH, SOUTH, EAST, or WEST. There are other commands as well, but it is up to you to figure out what they are.

While you are playing the game, the upper half of the screen shows your surroundings graphically, while the bottom half of the screen lets you know what is going on. The graphics are done in *PMODE 3*, and are generally pretty detailed. The text, also in *PMODE 3*, is also pretty good, although I had some trouble distinguishing some of the letters at first.

There is also some measure of randomness to the game. Every once in a while, a Goblin will appear and throw a knife at you, which may or may not be fatal. There is also a spider, who comes along to steal one of your treasures. If these kind of things annoy you, the odds of them happening can be easily changed, after studying the program for a while.

*Journey To Mt. Doom* is a very good Adventure. The graphics add a great deal to the enjoyment of the game, and it is difficult enough to keep you thinking for a while (or forever if you are as skilled at solving Adventures as I am). The only thing it lacks, is a "save game in progress" feature, which I feel should be a part of any Adventure game. The documentation is skimpy at best, but then you should not expect a great deal of help with this type of game. If Adventure games are your thing, *Journey To Mt. Doom* is a refreshing change from the "text only" variety.

(Tom Mix Software, 3424 College N.E., Grand Rapids, MI 49505, 32K disk \$27.95)

—Gerry Schechter

# The Original FLEX™ for Color Computers

- \* Upgrade to 64K
- \* RS to FLEX, FLEX to RS file transfer ability
- \* Create your own character set
- \* Automatic recognition of single or double density and single or doubled sided
- \* All features available for either single or multiple drive systems
- \* Settable Disk Drive Seek Rates
- \* Faster High Resolution Video Display with 5 different formats
- \* Save RS Basic from RAM to Disk
- \* Move RS Basic to RAM
- \* Load and save function on FLEX disk
- \* 24 Support Commands 12 with Source Text
- \* External Terminal Program

### Languages Available

Pascal, Fortran, RS Basic, RS Assembler, TSC Basic, TSC Assembler, Relocating Assembler, Macro Assembler, Mumps

If you are tired of playing games on your TRS-80C Color Computer or find that you are handicapped by the limitations of the RS BASIC in trying to write a Program that will allow you to actually USE the Color Computer as a COMPUTER YOU ARE READY TO MOVE UP TO THE FLEX9 Operating System. If you want to have REAL PROGRAMMING POWER using an Extremely Powerful Business BASIC, PASCALS, C Compilers, a full-blown Macro Assembler with a Library capability so you are not continuously re-inventing the wheel YOU ARE READY TO MOVE UP TO THE FLEX9 Operating System. If you would like to see if YOU REALLY COULD USE A COMPUTER IN YOUR BUSINESS or begin to make your Computer start PAYING ITS OWN WAY by doing some Computer Work for the millions of small businesses around you such as Wordprocessing, Payroll, Accounting, Inventory, etc. then YOU ARE READY TO MOVE UP TO THE FLEX9 Operating System. How?? DATA-COMP has the way!

DATA-COMP's FLEX9 Conversion for the TRS-80C Color Computer was designed for the SERIOUS COMPUTER USER; with features like greatly increased Display Screens WITH Lower Case Letters, so you can put a FULL Menu on ONE Screen or see SEVERAL Paragraphs at the same time, with features like providing a FULL Keyboard so you have FULL Control of your Computer AND it's Programs NATURALLY without needing a chart to see what Key Combination will give you what function, with USER ORIENTED functions to make using the Operating System natural, like having the Computer AUTOMATICALLY determine what type of Disk is being used in what type of Disk Drive and working accordingly, rather than you have to specify each and every thing for it, or like having the Computer work with the Printer you have been using all along without you having to tell the new Operating System what is there, etc.

\* FLEX is a trademark of Technical Systems Consultants

P.O. Box 794 HIXSON, TN 37343

DATA-COMP

1-615-842-4601

DATA-COMP has everything you need to make your TRS-80C Color Computer WORK for YOU; from Parts and Pieces to Full, Ready To Use SYSTEMS, DATA-COMP designs, sells, services, and SUPPORTS Computer SYSTEMS, not just Software. CALL DATA-COMP TODAY to make your Computer WORK FOR YOU!

### System Requirements

FLEX9 Special General Version x Editor & Assembler (which normally sell for \$50.00 ea.)	\$150.00
F-MATE(RS) FLEX9 Conversion Rout. for the RS Disk Controller when purchased with Special General FLEX9 Sys	\$49.95
when purchased without the General FLEX9 Sys	\$59.95
Set of Eight 64K RAM Chips w Mod. Instructions	\$59.95

Color Computer with 64K RAM and EXT BASIC **\$360.00**

### SPECIAL SYSTEM PACKAGES

64K Radio Shack COLOR COMPUTER, Radio Shack COLOR DISK CONTROLLER, a Disk Drive System, Special General Version of FLEX9, F-MATE(RS) and a Box of 10 Double Density Diskettes: a COMPLETE, ready to run SYSTEM on your Color TV Set. **\$1079.95**

### DISK DRIVE PACKAGES, etc.

These Packages include the Radio Shack Disk Controller, Disk Drives with Power Supply and Cabinet, and Disk Drive Cable

PAK #1	1 Single Sided, Double Density Sys	\$489.95
PAK #2	2 Single Sided, Double Density Sys	\$749.95
PAK #3	1 Double Sided, Double Density Sys	\$569.95
PAK #4	2 Double Sided, Double Density Sys	\$919.95
PAK #5	2 Qume Thinline, Double Sided Double Density Sys	\$749.95

### PARTS AND PIECES

Radio Shack Disk Controller	\$179.95
1 Single Sided, Double Density Disk Drive Tandem	\$249.95
1 Double Sided, Double Density Disk Drive Qume	\$349.95
1 Qume Thinline Double Sided, Double Density	\$279.95

Screen Clean — Clears Up Video Distortion On Your Color Computer **\$39.95**

Single Drive Cabinet with Power Supply	\$89.95
Double Drive Cabinet with Power Supply	\$109.95
Single Drive Disk Cable for RS Controller	\$24.95
Double Drive Disk Cable for RS Controller	\$34.95
Micro Tech Prods. Inc. LOWER CASE ROM Adapter	\$74.95
Radio Shack BASIC Version 1.1 ROM	\$14.95
Radio Shack Extended Basic ROM	\$89.95



## Suffering From Disklock? Then Use *Diskey!*

You've heard it said before, but I'll say it again: "If you have a disk system, then sooner or later a disk with your favorite/most critical program will crash!" And probably *without* a back up copy. So, you owe it to yourself and your CoCo, not to mention your loved ones who hate to see you beating your head against the wall, to get one of the disk fix utilities which is out on the market. I kept putting it off and between luck and taking good care of my disk and disk drives I didn't have much trouble. But, sure as Murphy, a couple of weeks ago my "working-on-it" disk, with over 40 man-hours of partially completed programs, bit the big byte. AARRRGGGHHH! I put the disk away for future salvage and luckily for me the review assignment that I received this time is *DISKEY Disk Access and Repair Key* from Adventure International. Serendipitous, yes?

I haven't seen any of the other disk fix utilities available in actual operation, so I can't really make any comparisons. But I do know that *DISKEY* does everything their ad says, and even has a "bonus" or two.

One thing I remember mentioned in a review of one of the other programs was the learning method used was to have you reconstruct the program disk itself, and *DISKEY* does this also. In addition, the information in the documentation is worth at least one-third of the price by itself. The documentation was *very* professionally done as you might expect from a company like AI, who has finally started supporting the CoCo (we knew it was worth it and I think now everyone else knows, too). It comes in a nifty 6 x 7 three-ring binder which contains the disk also and has fifty pages of instructions, info, tables and charts. My only minor complaint being that the copy quality of a couple of tables "faded" in places probably due to being line printer output rather than being typeset like the rest of the book.

You are given instructions on the operation of the program first. Then there is a tutorial on just how the RS Disk System sets up its directories files, etc. Following that are samples of the charts to be used when the program is run (see listings below) and tables of very useful information. Then there is the "walk-through" of how to recover the other two programs on the disk. These turn out to be a BASIC program that will act as a menu-driver for your disk allowing you to select and execute any program on your disk. One normal save and one in ASCII format to help you learn the differences between the two so far as recovery is concerned. There are also samples of the printouts available from the program.

The main program is actually two programs in one: the *DISKEY* section and a diagnostics section. The diagnostics test CoCo thoroughly and almost anything else you might have hooked up (disk, tape, printer . . .). Everything here is pretty much self-prompting and there is a section in the back of the book explaining all tests. Like the documentation this section alone is worth part of the price all by itself.

The main two routines of *DISKEY* are Disk Map and Examine Edit. Disk Map draws a graphic map of the disk being checked and color codes any sectors that have Read/Write/IO Errors so you know if your problems are firmware related or software glitches. Then Examine/Edit allows you to check data in all sectors and directly edit anything you find. This is where you collect the data needed by the Reconstruct Directory section that you learned how

to do in the "walk-through." The other routines available are:

**Erase Disk** — which "zeros" a formatted disk by writing FF hex to every byte.

**Backup** — which works like BASIC's but keeps you informed as it goes.

**Copy** — which copies by track numbers specified.

**Print Directory** — with a little more information.

**Calibrate Drive** — which is actually sort of a *MOTORON* for disk allowing you to perform some of the care and maintenance which is also outlined in the book (along with a safety warning and the advice not to try anything if you don't know what you are doing).

The only trouble I had with the program itself was that the arrow key movement around the edit display was touchy as heck and made it hard to put the cursor exactly where you wanted without overshooting a couple of times. Also, it would be nice if the examine section did a quick run-through of the disk and told you which granules had active sectors in them. You would still have to examine them "by hand," but it would be quicker than checking each gran yourself, especially if you're not sure how full the disk is.

But, these are only nit-picky details in a very professionally done program that does *so much!* By all means, if you have disks and don't have a disk repair utility then *DISKEY* would be an excellent choice.

(Adventure International, Box 3435, Longwood, FL 32750,  
disk \$49.95)

—Bruce E. Sterling

# GRAF PLOT

DRAWS A PICTURE WORTH 1000 WORDS



RAINBOW  
CERTIFICATION

**FREE!**

BUILT-IN SCREENPRINT  
FOR R/S PRINTERS:  
LP VII/VIII & DMP 100/200



GRAFPLOT 1.1 includes everything you need to go effortlessly from raw data to professional-quality printed graphs in minutes. Perfect for business, personal, educational, scientific and engineering applications. Free screenprint for R/S printers.

- \* Automatically scales and draws graph for best appearance.
- \* Full ASCII upper and lower case in 4 on-screen labels.
- \* Two fully labeled Y-axes. 200 or more data points per axis.
- \* 7 graphing symbols with unlimited overlay of data.
- \* Full function data editing: add, change, delete and sort.
- \* **Universal Screenprint Loader**— Automatically interfaces ANY screenprint program for non-Rainbow printers.
- \* Graphs and data output to screen, printer, tape or disk.
- \* Plots user-defined functions: projections, regressions, etc.
- \* Calculates moving averages (binomial smoothing), cumulative totals and integrals of data or user-defined functions.
- \* Saves completed graphs for instant reloading.
- \* Menu driven with complete error trapping and auto-prompting.
- \* Comprehensive manual w/ tutorials and sample data.
- \* Disk Only: display or print directory, kill or rename files.
- \* Many other labor-saving and time-saving features.

GRAFPLOT is available for 16K E.C.B. (\$35.00) and 32K E.C.B. (\$40.00) on cassette and for 32k disk (\$45.00) (U.S.). Send check or money order to: HAWKES RESEARCH SERVICES, 1442 Sixth St., Berkeley, CA, 94710. Manual available separately for \$10.00 + shipping, refundable with purchase. Include \$3.00 shipping on all orders. Dealer (30-50%) and club discounts (20-40%) available. VERSION 1.0 OWNERS—\$3.00 FOR EXCHANGE.



# YORK 10™ CASSETTES



**COMPUTER GRADE  
DATA TRAC  
BLANK CASSETTES**

**C-05, C-06, C-10, C-12, C-20, C-24, C-30**

From the leading supplier of Computer Cassettes, new, longer length C-12's (6 minutes per side) provide the extra few feet needed for some 16K programs.

-  **BASF-LHD (DPS) world standard tape.**  
Premium 5 screw shell with leader.
-  **Internationally acclaimed.**  
Thousands of repeat users.
-  **Error Free • Money back guarantee.**

**\* 500 C-12's or C-10's — 38¢ each**  
(w/labels, add 4¢ • Shipping \$17./500  
500 Boxes 13¢ ea. • Shipping \$10./500

**TRACTOR FEED • DIE-CUT  
BLANK CASSETTE LABELS**  
WHITE: \$3.00/100 \$20.00/1000  
**COLORED LABELS • Pastels -**  
Red, Blue, Green, Yellow, Lavender  
\$4.00/100 \$30.00/1000

**CASSETTE STORAGE CADDY**  
Holds 12 cassettes  
w/o boxes **\$2.95**  
Includes edge labels  
and index card

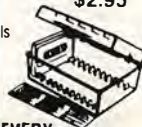

**FREE**  
1 CADDY WITH EVERY  
4 DOZ. CASSETTES PURCHASED



**Call: 213/700-0330** for IMMEDIATE SHIPMENT  
on Credit Card Orders



**ORDER  
NOW**

**MAIL  
TO**

**YORK 10™** 9525 Vassar Ave. #R1  
Chatsworth, CA 91311

**ORDER FORM**

ITEM	1 DOZEN	2 DOZEN	TOTAL
C-05	<input type="checkbox"/> 7.00	<input type="checkbox"/> 13.00	
C-06	<input type="checkbox"/> 7.00	<input type="checkbox"/> 13.00	
C-10	<input type="checkbox"/> 7.50	<input type="checkbox"/> 14.00	
C-12	<input type="checkbox"/> 7.50	<input type="checkbox"/> 14.00	
C-20	<input type="checkbox"/> 9.00	<input type="checkbox"/> 17.00	
C-24	<input type="checkbox"/> 9.00	<input type="checkbox"/> 17.00	
C-32	<input type="checkbox"/> 11.00	<input type="checkbox"/> 21.00	
Hard Box	<input type="checkbox"/> 2.50	<input type="checkbox"/> 4.00	
White Labels	<input type="checkbox"/> 3.00/100	<input type="checkbox"/> 20.00/1000	
Colored Labels Color	<input type="checkbox"/> 4.00/100	<input type="checkbox"/> 30.00/1000	
DESCRIPTION	PRICE	QUANTITY	
Storage Caddy	2.95		
<b>SUB TOTAL</b>			
Calif. residents add sales tax			
Shipping/handling (any quantity — using prices above)			3.50
Outside 48 Continental States — Additional \$1 per caddy, per doz. cassettes or boxes			
<b>TOTAL</b>			

Each cassette includes two YORK 10 labels only. Boxes are sold separately. We prefer to ship by UPS as being the fastest and safest. If you need shipment by Parcel Post, check here

**NOTE:** Additional charges outside 48 Continental States. Shipments to AK, HI, and USA possessions go by Priority Mail. Canada & Mexico — Airmail. All others — Sea Mail

**Ask about our  
DUPLICATING  
SERVICE**

CHECK OR M.O. Charge to  
ENCLOSED  Credit Card: VISA  MASTERCARD   
 PLEASE SEND QUANTITY DISCOUNTS

Card No. \_\_\_\_\_ Exp. \_\_\_\_\_

Name \_\_\_\_\_

Address \_\_\_\_\_

City \_\_\_\_\_ State/Zip \_\_\_\_\_

Signature \_\_\_\_\_ Phone \_\_\_\_\_

Computer make & model \_\_\_\_\_ Disk? (y/n) \_\_\_\_\_

## Clock Drill: An Education, Timely Tool

If you're among the fathers who, after mom has left for work, find yourself constantly telling the youngster to get his school clothes on, that we're running short on time, you will appreciate *Clock Drill*, an educational program from CY-BURNET-ICS of Knoxville.

*Clock Drill* is an autoload program requiring 32K, is menu driven and is designed to be both student and teacher friendly.

A large analog — you remember, the old kind, round and two revolving hands — clock is displayed on the screen for each problem. A seven-menu item offers the following options:

- On the hour.
- Half hour.
- Quarter after.
- Quarter till.
- Hour, 15 after, half hour, 15 till.
- Five minutes.
- By the minute.

On each screen, the computer randomly selects the time appropriate to the menu option. The student inputs the answer in a digital display at the lower lefthand part of the screen. If the selection is incorrect, a low buzz sounds indicating that he or she needs to try again. At any rate, the answer must be correct before going on to the next problem. Get it right and there's a neat little tick-tock, tick-tock sound for a reward.

A grandfather clock, complete with pendulum and a selection of "Hear the Chimes Ring," awaits the child when he makes 12 correct answers in a row.

A nice feature, especially for those who are in the early stages, is the presence of a help key, which, when pressed, signals the numeral representing the correct hour on the clock.

Pressing the spacebar once will display minutes incremented by five around the clock face. A second tap erases the display.

Included as a bonus with each program is *Clock Classroom Tutor*, which the creators say has been used in the classroom in Knox County, Tenn., for individual and large group instruction. It allows time comparison by the clock face, digital notation, and by spelled-out versions. It also includes placement and significance of the minute hand, and increasing difficulty as the program progresses.

For teachers in the lower grades who have had difficulty in locating good educational programs to go with those new-fangled computers that the board of education has placed in their classrooms, *Clock Drill* is for you.

(CY-BURNET-ICS, 5705 Chesswood Drive, Knoxville, TN 37912, \$24.95 on tape)

— Charles Springer

## "TRS-80 COLOR COMPUTER PRODUCTS"

### "ENHANCED 1248-EP EPROM PROGRAMMER"

The list of directly compatible EPROMs increases by one, now including: 2508's, 2758-0/1's, 2516's, 2716's, 2532's, 2732's, 68732-0/1's, 68764's, and 68766's.

#### NEW FEATURES INCLUDE:

- 1) Intelligent algorithm that reduces programming time to as little as 1/6 that of fixed cycle programmers.
- 2) Diagnostic routines to isolate defective EPROMs, or locate differences.
- 3) A feature that guards against EPROM type entry errors.
- 4) Diagnostic routines that prevent keyboard entry errors from causing disastrous consequences.

#### FIRMWARE FEATURES

- 1) EPROM ERASED!
- 2) COMPARE EPROM TO RAM!
- 3) BLOCK PROGRAMMING!
- 4) BYTE PROGRAMMING!
- 5) DUMP EPROM TO RAM!
- 6) JUMP!

Firmware is "stack-oriented", "position independent", and "menu driven". Supplied in an EPROM, it can also be stored on disc or tape for execution from RAM if desired.

#### STANDARD HARDWARE FEATURES

- 1) It has its own "on-board" 25 volt programming supply.
- 2) A quality textool "zero insertion force" (ZIF) socket.
- 3) Socket for firmware on-board.

A PIA port is also available on the programmer. This 8 bit parallel I/O port with handshake lines, can be used for many applications, such as a parallel printer port. Details on how to use this port as a printer interface are included in the instruction manual.

The instruction manual describes how to take full advantage of the power of this versatile programmer. We think you'll agree, that never before was an EPROM programmer so easy to use, and feature packed as is the 1248-EP.

The enhanced 1248-EP costs only \$129.95.

Firmware upgrades are available to our previous 1248-EP customers, in EPROM, for just \$29.95.



\* TRS-80 is a trademark of TANDY CORP.  
\*\* SDS80C is a trademark of the MICRO WORKS.

### "THE CK4 SERIES PROM/RAM CARDS"

The CK4 cards work with 2K, 4K, and 8K ROMs or EPROMs of the 5 volt only variety in 24 pin packages. The CK4 can also work with static RAMs, and increase your available memory by as much as 16,128 bytes.

The CK4-1 is specifically designed for use in computers with "F" series boards, or those machines that are "write protected" in the address range of \$C000 through \$FEFF. The CK4-1, therefore, does not incorporate features designed in the CK4 for use with RAM.

The CK4-2 is the unpopulated version of the CK4 series board. Buy this version and configure to meet your specific requirements, and stretch the value of your dollar.

#### FEATURES SUMMARY

- |                           |                                 |
|---------------------------|---------------------------------|
| 1) MIX ROM AND RAM!       | 4) EXTREMELY FLEXIBLE DECODING! |
| 2) EXPAND RAM FROM 2-16K! | 5) PROVIDES FOR BATTERY BACKUP! |
| 3) YOU WRITE PROTECT RAM! | 6) LOW COST!                    |

#### PRICES

CK-4 \$29.95 ea.      CK4-1 \$27.95 ea.      CK-2 \$15.95 ea.

### NEW PRODUCT OFFERING

#### A/D-80C ANALOG TO DIGITAL CONVERTER BOARD

The A/D-80C is a 16+ channel analog to digital converter with two 8 bit PIA ports plus handshake lines.

- \* Implement closed-loop control of analog processes!
- \* Use it to control your homes environment!
- \* Computerize your laboratory or darkroom!
- \* Build a multi-channel voltmeter!
- \* Use it for waveform generation!
- \* For robotics!

The A/D-80C is software programmable up to a maximum of 10 bits of resolution. The number of channels can be expanded beyond the 16 channel capability supplied, and the channels are software selectable.

The A/D-80C performs nearly 9K A/D conversions per second. A generous area of the board is designated for wirewrapping to permit customization of analog signal processing circuitry.

Extensive documentation is provided to assist the user in the development of his application. Software listings are provided as an aid to software development, and a socket is provided for an EPROM for user developed software drivers.

CONSULT FACTORY FOR AVAILABILITY AND PRICE INFORMATION ON NEW PRODUCTS.

#### FACTORY FRESH COMPONENTS:

ITEM	DESCRIPTION	PRICE
2716 EPROM	2K by 8 Bit.	\$4.50 ea.
2532 EPROM	4K by 8 Bit.	\$6.50 ea.
6821P	PIA.	\$3.50 ea.
74LS156	Open collector decoder	\$1.70 ea.
Socket	Textool "Zero Insertion Force"	\$9.00 ea.

Minimum component order: \$25.00

#### ORDERING INFORMATION:

Add \$3.00 to all orders to cover shipping and handling. Canadian residents add 5% to cover special handling. Arizona residents add 5% sales tax. All items shipped UPS. Please allow 2-3 weeks for delivery. Prices subject to change without notice.

Make checks payable to

**COMPUTER ACCESSORIES OF ARIZONA**  
**5801 E. VOLTAIRE DRIVE**  
**SCOTTSDALE, ARIZONA 85254**  
**(602) 996-7569**

## Order Entry System Provides Sales Help

*Order Entry System* is a neat little package that a small business could use to print invoices and keep track of sales. To use this program, you need at least a 32K Color Computer with one disk drive, and an 80-column printer. The documentation also says you need the Mark Data Products *Super Screen* program which is included on the disk. The *Order Entry System* is actually a combination of several programs that are menu driven.

In order to tailor the program to your specific needs, you will have to delete some data statements that are used for the demonstration program and include some of your own. You may also need to make some other changes to make the program compatible with your printer. This is really no problem, though, as the instructions are written quite well.

With *Order Entry System*, you will be able to print: Invoices, Sales Reports (either daily, monthly, or for any other period), and a Receivables Report. Creating, modifying, updating and maintaining the data files is quite easy. As I mentioned earlier, there is a demonstration program used as a tutorial that will have you capable of operating and understanding the system within one hour. The documentation (23 pages) is written quite well. There was one place, however, where the documentation could have been a little more clear; that is in the tutorial section on reviewing records. The tutorial tells you to type in the record number you want to review. The only problem is, you don't know how many records there are yet unless you are very perceptive and noticed it on the screen. Anyway, as long as you press the number 12 or less you will be okay.

The heart of the *Order Entry System* is the *SALES.BAS* program. This is where you actually enter your sales orders and prepare the invoices for shipment. With a single disk system you can enter up to 488 transactions and, with two drives, you can store over 600 transactions.

### Hints . . .

## Color Computer 2 Warning

If you are upgrading your new CoCo 2 to 64K, remember that the 16K chips you are taking out are *not* the same as the 16K chips (type 4116) that earlier CoCos used; they are type 2118, which use a different power supply (+5 volts only) and *will not* work in earlier units, and could cause damage. (If you intend to do a 32K "piggyback" expansion on your CoCo 2, use another set of 2118s, *not* 4116s that came out of an older computer.)

A sales order is either *closed* (cash, check, money order, credit card) or *open* (C.O.D. or open account). As you enter each order it is placed in the appropriate open or closed file and a multiple copy invoice is prepared. (The documentation does include a sample of the type of invoice the program is written for.)

When you receive payment for an order that is on open account or a C.O.D. you can credit the account by selecting the "close and open order option." To enter a sales order, you will be asked to input the following information: Ship To, Bill To, Purchase Order Number, Method of Shipment, Terms of Sale, and various Product and Discount Information. You do have the option of combining sales of products that have different discounts on a single invoice. You also have the option of adding tax, C.O.D., and handling charges to the invoice.

The other options of *Order Entry System* allow you to print out reports of closed orders (sales) and reports of open orders (receivables). The report of closed orders will print out the following information for each order: invoice number, date of transaction, terms of sale, net sale, tax, shipping charges, C.O.D. charges, and the total sale price. Once this information is printed out you will get another report which gives you a sales breakdown. The sales breakdown will tell you how many of each item you have sold and the total amount of revenue each item has produced. This report will also tell you how much of your total receipts was Cash/Money orders, Checks, or Credit cards. The report of open orders will print out the same reports but will be for invoices you haven't received money for yet. The reports can be requested for a single day or the entire month.

In general, I feel this is a good program that would serve the invoicing needs of a small company quite nicely. There are a couple of items, though, that are quite inconvenient and may cause you some concern. When entering information for the invoice, if you realize you made a mistake a couple of lines above, you must use the [up arrow] to get to that line. This would be no problem *except* that it *wipes out* all the information between your current line and the one you are going to. It would have been nice if the program had a feature that allowed you to select the line number that needed correcting like many other data entry programs do.

There was one other problem that I ran into in entering information for the invoice. When entering the "Bill To:" information you can type the word "SAME" if it is the same as the "Ship To:" information. The program will then automatically skip the rest of the "Bill To:" section so you don't have to enter the information twice. This works fine unless you are using the lowercase mode, in which case, the program doesn't recognize the lowercase "same." This problem also cropped up when I attempted to enter additional items for the invoice. As you complete an item on the invoice, you are asked if you want to add another item. If you do, you are to respond with an [N] which represents "NEXT." If you are in lowercase and respond with an [n], the program does not allow you to continue as you intended. These are not that big of a deal, but if you buy the program, you should at least be aware of them.

If you are looking for a program to keep track of your sales and print invoices, then this one will take care of these needs quite well.

(Mark Data Products, 24001 Alicia Parkway, No. 207, Mission Viejo, CA 92691, disk \$99.95)

— Michael K. Hunt

# DEFT™ Systems, Inc.

## Colour Software Workbench™



The **Colour Software Workbench (CSW)** is a system of **machine language** programs that run on a 32K or 64K TRS-80 Color Computer Extended Disk Basic System. It lets you develop machine language programs in a combination of **Pascal** and **6809 Assembler** source languages. The **240+ page CSW User's Guide** that is included explains the fundamentals of the languages as well as how to use the package.



Part ONE of the CSW User's Guide tells you how to use all of the programs in the Workbench. This first part contains one section for each program.

### TEXT EDITOR

- Screen Mode Editing
- Entering Text
- Finding Strings
- Changing Multiple String Occurrences
- Moving, Copying and Deleting Blocks of Text
- Reading, Writing and Merging Files From Tape and Disk

### PASCAL COMPILER

- Specifying:
  - Source from Tape, Disk or Keyboard
  - Object and Listing to Tape, Disk, Screen or Printer
- Optional Symbol Table in the Object File for use by the Symbolic Debugger
- Explanation of Source Listing Format

### MACRO ASSEMBLER

- Specifying:
  - Source from Tape or Disk
  - Object and Listing to Tape, Disk, Screen or Printer
- Explanation of Source Listing Format

### OBJECT LINKER

- Specifying:
  - The Machine Language ORIGIN
  - Listing to Tape, Disk, Screen or Printer
  - Binary File on Disk
  - Whether to use Pascal Runtime Library
  - Whether to use Symbolic Debugger

### SYMBOLIC DEBUGGER

- Setting and Clearing Breakpoints
- Displaying and Modifying 6809 and Graphics Registers
- Displaying and Modifying Memory
- Using Pascal Symbols
- Tracing Pascal Procedure Activations
- Viewing the User's (Graphic) Screen
- Using Symbols, Registers & Constants in Expressions



**\$150.00**



3% Shipping & Handling, 5% Maryland Sales Tax

To order, send Name and Address and check or money order to:

DEFT Systems, Inc.  
P.O. BOX 359  
DAMASCUS, MARYLAND 20872

or **CALL TOLL FREE: 1-800-368-3238** Operator 8

(in Virginia) **1-800-542-2224** Operator 8

Shipped UPS as soon as your check clears, sooner if you charge, MasterCard and VISA accepted.

"TRS-80" and "Color Computer" are Trademarks of TANDY Corporation

Part TWO of the CSW User's Guide provides you with the background information needed to write programs using the Colour Software Workbench.

### LEARNING EXERCISE

- Complete Pascal and Assembler Language Source
- Uses All Parts Of the Workbench
- Resulting Program is a Text Processor

### PASCAL

- Describes Standard Language Elements Supported
- Constants Include Decimal and Hexadecimal Integers, ASCII characters and strings
- Types Include:
  - Integer, Char, Boolean, Enumerated, Subrange
  - Multi-Dimensioned Arrays
  - Records and Variant Records
  - Sets of Up to 256 Elements
  - Files
- PROCEDURES and FUNCTIONS with FORWARD
- Variables and LABELS
- Arithmetic, Boolean, and Set Expressions
- Statements: IF, WHILE, REPEAT, CASE, GOTO, EXIT, FOR, BEGIN, assignment (: =)
- Input/Output: RESET, REWRITE, READLN, EOF, WRITE, WRITELN, CLOSE, PAGE
- Built-in Functions and Procedures: ABS, CHR, CURSOR, ODD, ORD, PRED, SUCC

### ADVANCED PASCAL

- Strings Support: Assignment, Comparing, Concatenation
- String Procedures and Functions: STRINGCOPY, STRINGDELETE, STRINGINSERT, STRINGPOS, HEX, ENCODE, DECODE
- Type Extensions for Structured Type Breaking
- Absolute Memory Access via Built-in WORD and BYTE Arrays
- ROM Routine Access via CALL Built-in Function
- Static and Public Variable Allocation
- Separate Compilation and Assembler Interface via INTERFACE, EXTERNAL, and PUBLIC
- Listing and Multiple Source File Directives
- Explanation of Error Messages

### 6809 MACRO ASSEMBLER

- Motorola Compatible Source Conventions
- Macro Facility With up to 9 Macro Parameters
- Separate Compilation and Pascal Interface via PUBLIC and EXT Directives
- Listing Control Directives
- Explanation of Error Messages

### TECHNICAL NOTES

- CoCo ROM Compatibility
- Pascal Runtime Library Assembler Interface
- CSW Object File Format

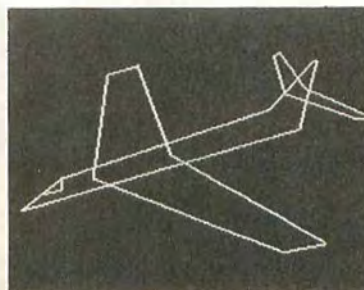

Hi-resolution and 3-dimensional skeletal **graphics** packages included. This includes full Pascal & Assembler source code. Includes: HIRESCLEAR, HIRESLINE, GRAPHDISPLAY, MOVESKELETON, SHOWSKELETON

DEFT and "Colour Software Workbench" are Trademarks of DEFT Systems, Inc.

## Cashman: A Fun Investment

One of the main reasons I bought a CoCo was to play colorful arcade games, so I'm always glad to get the opportunity to review one. I did, however, experience one very small problem in reviewing *Cashman*, which I'll tell you about shortly.

But first, let me tell you about the game. *Cashman* is a 32K self-starting, machine-language game from Computer Shack, available on disk or cassette. Although it may appear to bear some superficial resemblance to *Canyon Climber* or *Donkey Kong*, it is totally unique.

One thing that makes it quite different from any other video games I have ever seen is the fact that, when two players are competing, they do not just alternate taking turns. They actually play together on the same screen, vying for treasure and hurling eggs at each other. (Hurling eggs? That's another unique feature!)

There are more than 40 screens. The instructions do not specify how many more, but since "experts" may begin playing on screen 40 if they wish, I wouldn't be surprised if there are more than 50!

In a two-player game, one player uses the left joystick to move a character called the "Sheik," and the other player uses the right stick to control the "Sailor." In a one-player game, you can pick either one. Although the Sheik has a blue hat and orange shoes, and the Sailor has a white hat and blue shoes, these distinguishing features are very small, and while playing the game with my wife, I occasionally found

myself trying to move the wrong character after they crossed paths on the screen.

The object of the game is to clear the screen of \$50 bills, represented by dollar signs. You move horizontally along "girders," or vertically up or down ladders or ropes, called "climbers." Jumping is accomplished by pressing the fire button. Unlike some other well-known climbing games, there's no penalty for taking a fall. (In fact, on some screens, the only way to collect a dollar sign suspended in mid-air seems to be to fall through it.) When you collect all the money on one screen, you're automatically advanced to the next one.

Along the way you may find some "conveyors," which are a sort of moving sidewalk, and "flingers" — little trampolines that will give your jumping and extra boost. But watch out: Don't step on a "zapper" — that will cost you one of your 10 game lives. The easiest screens have no zappers at all, while the "experienced" and "expert" screens have several.

Other critters you'll meet during your treasure hunt are "Bombs," "Eggs," "Kats," and "Byrds." (The last two bear an amazing resemblance to cats and birds.) A Bomb will turn into an Egg or a Kat after a while, unless you grab it first (which scores \$30 for you). If you get hold of an Egg, you can throw it at your opponent (costing him one game life), a Kat (good for \$150), or a Byrd (\$250!). If you don't grab an egg, it will soon hatch into a Byrd.

Run away from Kats. Contact with one costs you a game life. The Byrds can be helpful. If you let one grab you, it will lift you up to a higher elevation. On some of the "no jumping allowed" screens, that seems to be the only way to get up there. Of course, there's always the danger that it will drop you off right in the path of a Kat.

The screens are divided into six "areas." The first four are "easy." The next six are "super jump." As the name implies, all the jumps are much higher. There are 12 "moderate," five "no jumping allowed," and 12 "experienced" screens. After all that comes the "expert" area which begins with number 40. You may choose to start at number 1, or you may start to play at the beginning of any of the areas. That way, the great players can go directly to a level that challenges them, while novices like me can at least get a look at what the higher levels involve.

There is a scoreboard that keeps track of six high scores — but your first six games won't automatically earn a place on it. Arbitrary scores have been assigned to six characters with funny nicknames, and you'll have to beat at least one of those to earn the right to enter your name.

There's even an alternate color set. The normal colors are orange, blue and white on a dark background with a white border, but by depressing the spacebar at the start of each game, you can shift to pink and green graphics on a white background. I found this alternative color set a bit fuzzy and hard to play with, but I suspect that that is probably the fault of my very old color TV rather than the program.

The instructions are well-written and easy to understand. Although it may sound complicated, once you start playing you'll find it very easy to get into.

As I mentioned earlier, I had one small problem in trying to review *Cashman*: I found it very tough to tear myself away from *playing* the game long enough to write about it! In short, *Cashman* is one fun game. Buy it.

(Michtron [formerly Computer Shack], Pontiac, MI 48034, cassette \$27.95, disk \$29.95)

— Neil Edward Parks

The

# ORACLE II

The Ultimate CoCo Monitor.



The ORACLE II is not a rehashed monitor program adapted to the CoCo, but a state of the art monitor designed to compliment the CoCo and its unique abilities.

Compare some of our features:

- 64K Compatible - the ORACLE II can relocate itself and its monitor screen above disk basic.
- Single Stepper - a single variable speed stepper that allows you to step both rom and ram
- Disassembler -
- Graphics Support - allows you to step a program while watching any graphic screen, in any graphic mode, and toggle between the monitor screen and back, with one key
- ASCII/hex search up to a 10 byte search.
- Full screen display and editing of memory
- Over 40 commands.

CoCo disk or tape (both versions included)	\$35.95
Spectral or FHL Flex version	45.95
(+ \$2.00 shipping and handling)	



## MICRO MAGIC

P O BOX 142, SUMNER, WA 98390  
(206) 863-8762  
{24 Hours}







There ain't much more to know about your microcomputer when you own a NANOS SYSTEMS CARD.



System Reference Cards  
FOR THE  
MICROCOMPUTER

# This is the standard!

# The finest product of its kind in the world!

New Products being finalized now.

ATARI 400/800  
TI99/4A  
IBM PC  
CP/M  
EPSON PRINTER  
TS-2000  
PET  
APPLE IIe

Each card is stretch-wrapped for protection  
Compact Display Units available for your store  
A beautiful color poster (18 in. X 24 in.) is available with your store order.

"This is just what I have been looking for to help me get beyond the poorly planned and executed manuals."  
**T.P.C., West Palm Beach, Florida**

You can order direct from England.

ELKAN ELECTRONICS  
FREEPOST  
11 BURY NEW ROAD  
PRESTWICH  
MANCHESTER, ENGLAND  
M25 6LZ  
PHONE: 081-798-7813

No Shipping costs in Europe

CARDS	PRICE
DRAGON 32	£3.95 \$5.95
TRS80 COLOR BASIC & EXTENDED	\$4.95
COMMODORE 64	\$5.95
COMMODORE VIC-20	\$5.95
ATARI 400/800	\$5.95
ZX80, ZX81, & TS-1000	\$5.95
HEATH/ZENITH HDOS 2.0	\$5.95
APPLE II & II PLUS BASIC & 6502	\$4.95
APPLE II & II PLUS BASIC	\$3.95
Z80 MICROPROCESSOR	\$4.95
6502 MICROPROCESSOR	\$4.95
TRS80 MOD II 3-CARD-PACK (B&A, SVC, C&U)	\$11.95
TRS80 MOD I BASIC & ASSEMBLER	\$4.95
TRS80 MOD III BASIC & ASSEMBLER	\$5.95
TRS80 POCKET BASIC (PC-1) [SHARP PC-1211]	\$2.95
TRS80 MOD I BASIC	\$2.95
TRS80 MOD III BASIC	\$3.95

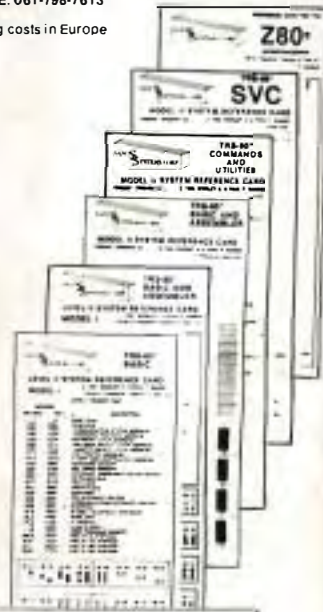
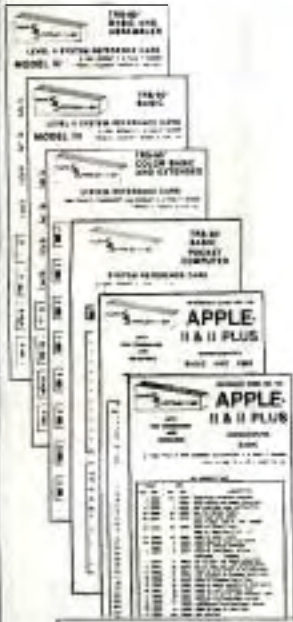

NANOS SYSTEMS REFERENCE CARDS - QUICK REFERENCE FOR YOUR MICROCOMPUTER

OVER 125,000 SOLD WORLD WIDE

The most popular quick reference ever produced for microcomputers!

This is the finest, most comprehensive, complete, and most truthful document you may ever find for your microcomputer

It is an accordion-fold document, printed on 80-lb Beckett cover stock for durability, prepared by large-scale computer professionals who have over 20 years experience, and it is made the way they need it for their own usage

Each item of information on the card is expressed in its simplest terms so that even the beginner can understand what is being said.

The NANOS SYSTEMS CARD is not a tutorial, but, it is not a technical document either. It simply presents nearly everything you might need to know about using, operating, and programming your microcomputer in plain words so that you can quickly grasp every concept.

NANOS SYSTEMS CARDS are used in many homes, businesses, grammar and high schools, technical schools, major colleges and universities, and, would you believe, the U.S. NAVY!

NANOS SYSTEMS CARDS are not just another quickly-produced bunch of publications for the purpose of grabbing sales while the public is still confused about the proper literature to buy. On the contrary, they are inexpensive, and, can represent information which you might otherwise spend from twenty to one hundred dollars to get, because not only do they summarize the manuals, but, NANOS researches each computer and inserts information not readily available anywhere else

For example, one very large publisher has been marketing what they call a "Quick Reference" card. It is oversized and awkward to handle and transport. It contains 8 pages, 2 of which contain nothing about your computer at all! The other 6 pages are spread out to fill the rest of the card with as much as possible, with not much information. It sells for 2.95. The NANOS SYSTEMS CARD for the same microcomputer has 16 pages, all used and packed full of information. The entire contents of the 2.95 card above are contained in about 3 pages of the NANOS CARD. The NANOS CARD is 4.95, and, it fits in your pocket!

Another publisher puts out a large full-sized plastic sheet which is so technical that even NANOS himself cannot understand it all!

And finally, there are some who are publishing little mini-books and calling them "Quick References". The idea of a quick reference is to get away from the book format. It is archaic and time-consuming.

The NANOS SYSTEMS CARD is the true QUICK REFERENCE for today's users. Not only does it make an original presentation, but, it is organized so that you can identify your subject instantly, and that's pretty last.



"Thank you for your high quality product..."  
**J.M.B., Middletown, Rhode Island**

NANOS SYSTEMS CORP.  
P.O. BOX 24344  
SPEEDWAY, IN 46224  
(317) 244-4078

"Thanks for the card."  
**T.N., Park Ridge, Illinois**

# NEW FROM DSL

## INATAK

By Hong Kwong

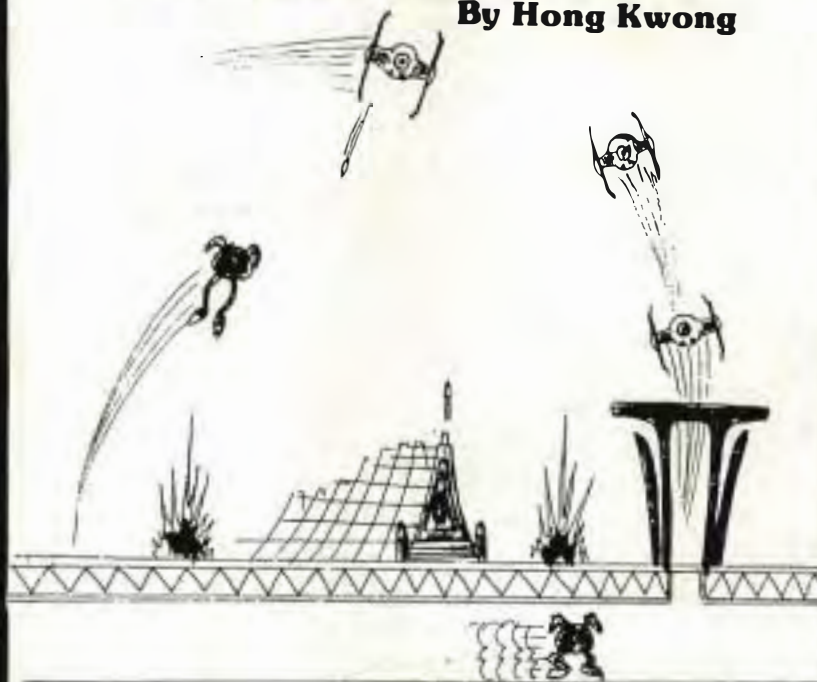

**COMPLETELY ORIGINAL FAST ARCADE GAME.  
REQUIRES MINIMUM 16K EXTENDED**

**\$24.95**

TAPE OR DISK, PLEASE SPECIFY

**DSL COMPUTER PRODUCTS INC.**

**313-582-8930 • 313-582-3406 (Data)**

**P.O. BOX 1113 • DEARBORN, MI 48121**

Michigan Residents Add 4% Sales Tax to Order. Please include \$1.00 for S & H.

MasterCard

VISA

# DSL COMPUTER PRODUCTS INC.

## GAMES

DEATH TRAP	19.95 (C)
CATERPILLAR	19.95 (C)
HAPPY HURDLER	12.95 (C)
POLARIS	29.95 (R)
SPACE ASSAULT	29.95 (R)
SHARK TREASURE	24.95 (C)
KEYS OF THE WIZARD	19.95 (C)
MUDPIES	29.95 (C)
TRAPFALL	27.95 (C)
AIR TRAFFIC CONTROLLER	28.95 (C)
GRABBER	27.95 (C)
SPACE SHUTTLE	28.95 (C)
DEVIL ASSAULT	27.95 (C)
BUZZARD BAIT	27.95 (C)
THE KING	26.95 (C)
BLACK SANCTUM	19.95 (C)
CALIXTO ISLAND	19.95 (C)
EL BANDITO	24.95 (C)
GLAXXONS	24.95 (C)
ASTRO BLAST	24.95 (C)
SHENANIGANS	29.95 (D) 24.95 (C)
SPACE RAIDERS	24.95 (C)
CAVE HUNTER	24.95 (C)
STARSHIP CHAMELON	24.95 (C)
DOODLEBUG	24.95 (C)
STAR BLASTER	39.95 (R)
EL DIABLERO	24.95 (C)
STORM	24.95 (C)
ROBOTTACK	24.95 (C)
THE FROG	30.95 (D) 27.95 (C)
GALAX ATTAXX	21.95 (C)
DEFENSE	21.95 (C)
COLORPEDE	29.95 (C)
MAZE RACE	14.95 (C)
BIRD ATTACK	21.95 (C)
ANDROID ATTACK	21.95 (C)
COLOR HAYRIDE	24.95 (C)
BALLOON ATTACK	29.95 (D) 24.95 (C)
COLOR DFT	25.95 (C/D)
COLOR FURY	27.95 (C)
CASHMAN	27.95 (C)
OUTHOUSE	27.95 (C)
AIRLINE	24.95 (C)
AREX	34.95 (C)
ZAXXON	39.95 (C)
POOYAN	29.95 (C/D)
MOON SHUTTLE	29.95 (C/D)

## EDUCATIONAL

MATH DRILL	19.95
SPELLING TEST	19.95
WORD DRILL	19.95
ESTIMATE	19.95

## ACCESSORIES

NANOS CARD	4.95
EPSON RIBBONS	7.49
BLACK, BLUE, RED, BROWN, GREEN	
C-10 DATASETTE	1.25
C-20 DATASETTE	1.50
GEMINI RIBBONS	2.95
LP VII, DMP 100, TPI RIBBONS	4.95
DISK MAILERS	0.95
10 PACK	8.95
DISK SAVERS	.59
12 PACK	5.95
DISKS	
SENTENIAL 99/SD	19.95
SENTENIAL 99/DD	22.95
VERBATIM	34.95
DISK DOUBLER	11.95
GRAND SLAM 64K KIT	75.00
16-32K RAM SLAM	49.95
2 WAY RS 232 SWITCHER	29.95
3 WAY RS 232 SWITCHER	39.95
4 TO 4 PIN CABLE	4.95
CASSETTE CABLE	5.95
MASTER CONTROL II OVERLAY	2.50
64 K RAM BUTTON	2.95
BOTEK INTERFACE	59.95
FOR EPSON	69.95
MD KEYBOARD	69.95
MULTI PACKS	
DSL GREATEST HITS	
TAPE	39.95
DISK	49.95
COLOR LOAD 80	
VOLUME II	9.95
VOLUME III	9.95
RAINBOW ON TAPE	
DEC. 83	6.50
NOV. 83	6.50
OCT. 83	6.50
SEPT. 83	6.50

## UTILITIES

COLOR GRAPHIC EDITOR	19.95 (C)
SUPER SCREEN	29.95 (C)
GRAPHIC SCREEN PRINT	
EPSON	9.95 (C)
OKIDATA	9.95 (C)
GEMINI	9.95 (C)
PROWRITER	9.95 (C)
LP VII/RS	7.95 (C)
LOGICAL DISK COPY	14.95
EDTASM +	49.95 (R)
TAPE DIRECTORY	14.95 (C)
TAPE TO DISK	17.95 (C)
DISK TO TAPE	19.95 (C)

## APPLICATION

THE GENERAL	TAPE	39.95
	DISK	49.95
DISK MAILER		24.95
TELEWRITER	TAPE	49.95
	DISK	59.95
SUPER COLOR WRITER		
TAPE OR DISK		59.95
PERSONAL FINANCE		39.95 (R)
ELECTRONIC CALLIGRAPHER		18.95 (D)
SUPER CONTESTER I		14.95 (C)
SUPER CONTESTER II		24.95 (C)
COUNTRY LOCATOR		14.95 (C)

## HARDWARE

32/64K TDP 100	219.00
32/64K EXT TDP	309.00
32/64K CC2	209.00
32/64K EXT CC2	299.00
TDP LINE PRINTER I	249.00
GEMINI STX 80	199.00
GEMINI 10X	349.00
GEMINI 15 X	499.00
CASSETTE RECORDER	49.95
STD. JOYSTICKS	10.00
ATARI JOYSTICKS	14.95
DISK DRIVE 0	349.00
DISK DRIVE 1,2, OR 3	249.00
DUAL HALF HEIGHT	499.00
MODEM I	99.00

## CLOSE OUTS

CO RES9 V.14 E/A	14.95 (C)
COSMIC SUPER BOWL	7.50 (C)
WAR KINGS	9.95 (C)
MAGIC BOX	12.49 (C)
ANMATED HANGMAN	6.50 (C)
SPACE INVADERS	10.95 (C)
DANCIN DEVIL	4.95 (C)
BUSTOUT	5.00 (R)
TYPING TUTOR	9.95 (C)
STAR BLASTER	19.95 (R)
POCKET COMPUTER WITH	150.00
PRINTER & EXTRAS	

**P.O. BOX 1113 • DEARBORN, MI 48121**  
**313-582-8930 • 313-582-3406 (Data)**

Michigan Residents Add 4% Sales Tax To Order

Please include \$3.00 for N & H

MasterCard

VISA

## Key-264K — The Key To Flexible Programming

By Donald D. Dollberg

Being somewhat of an old timer with the Color Computer, having started with a 4K Color BASIC machine over two years ago, I've had the opportunity to watch the growing and continuing support from third party software vendors. I've also had the opportunity to upgrade that 4K machine to 64K Disk Extended BASIC with new keyboard and video monitor. With the wave of new 64K machines, comes what I call 64K hysteria — "What can I do with 64K?" Everyone I know is convinced that OS-9 is the answer. Sure, it's a great system and adds tremendous capability (and prestige) to CoCo. If you're into heavy programming or need to use some heavy business type software, then OS-9 (or FLEX) might be the answer. But, what about the casual BASIC programmer who is happy with Color TRS-DOS? I believe that *Key-264K* by Key Color Software is the answer.

*Key-264K*, by Neil Capeless comes on a cassette and requires Extended BASIC and good 64K RAMs — the so-called half good 64K chips which Radio Shack presumably put into the early 32K CoCos, will not work. The program is protected with an auto start loader and cannot be copied to disk although it is fully compatible with Disk BASIC. Although the program is small, 3.225K bytes and loads quickly, some disk users may be irritated having to resort to

tape. I spoke with Mr. Capeless about this and he assured me that a disk version was available since January. Those who already have the tape version may upgrade to disk for a modest upgrade charge of \$5 plus shipping. Disk versions are available for both the 1.0 and 1.1 Disk ROM.

In addition to the program, a 75-page manual is included. Present software authors would do well to emulate Mr. Capeless' documentation. This is a professional product which is extremely well written on high quality paper and obviously offset printed. The first 50 pages are devoted to a tutorial or learning guide. It is designed to be used while working with the system. Each command is fully discussed with examples to be entered into the computer. After running each example, the command is then summarized with reinforcement. By working through the tutorial, one develops a basic understanding of each command. But, as with any new system, there is often the need to refer to the manual. The last 25 pages of the documentation serve as a reference manual. Now this is not just a list of commands either. Each command is summarized on a separate page. For each command, four topics are listed: command format, purpose, comments and examples. Each page is neatly presented in outline format so it is very easy for the eye to scan the page for the needed information.

I realize that I have spent a lot of time commenting on the manual but high quality documentation takes a lot of time to produce and should not go unrecognized. Anyone, even with a very elementary understanding of BASIC, will appreciate the manual and find it very easy to read and understand.

Before I get into the details of this utility, I think that it would be useful to quickly review the two memory options available with a 64K RAM machine. On power up, the SAM (6883 synchronous address multiplexer) configures the system to the 32K ROM/32K RAM mode (memory map 0). This is the standard 32K BASIC machine. However, if you whisper the right bits to SAM, the BASIC ROMs will be turned off and 64K RAM is left (memory map 1). But, this RAM is useless without an operating system such as OS-9 or FLEX. If we want to use BASIC then we are confined to 32K RAM — or are we?

With memory map 0, SAM can perform a function known as page or bank selection. What this means is that either the lower half of the 64K RAM, ie, 0 to \$7FFF can be assigned to BASIC or the upper half \$8000 to \$FFFF. With a small operating system which can perform bank selection, the two banks of memory can be easily accessed. Several utilities have recently appeared which make use of the two memory banks. However, these utilities use the upper bank for storage of programs which can be loaded to the lower bank or the reverse, programs in low memory saved to the upper bank.

While this type of utility serves a useful function, particularly for those without a disk system, *Key-264K* takes a different approach. It provides for both independent program operation in each bank either separately or simultaneously in a multi-tasking environment as well as complete interaction between both banks such as a program in one bank and the variables, subroutines, or extra graphics pages in the other bank.

Let's look at *Key-264K* and its operation. A simple *CLOADM* automatically loads the program at the top of 32K in both banks, ie, about 29.5 K is left in either bank for programming. Once *Key-264K* is installed, it immediately does a cold start of both memory banks and adds 16 new commands, which are listed in Table I, to BASIC. In addition, several keys are used for each side to perform such

**NEVER UNDERSOLD**  
— Leader Since 1980 —

**COMPUSETTE.**  
at  
Manufacturer Prices

Industries Finest



AQPA PE. 611

	Retail	Your Cost
C-05	99¢	55¢ each
C-10	\$1.29	59¢ each
C-20	\$1.59	69¢ each
C-30	\$1.89	89¢ each
Cases	49¢	21¢ each

**Packed 24 Per Pack**

**UPS \$3.00 Per Pack 48 States**

**Micro-80™ INC.**  
2665 Busby Rural Rd  
Oak Harbor, Wash. 98277

**IMMEDIATE SHIPPING**  
**(206) 675-6143**

tasks as break, warm and cold restarts, toggle Extended and Disk BASIC, initiate multi-tasking, and duplicate one side to another. For example, the "down arrow" key serves as the control key for side A — the foreground side — while the right arrow serves as the control key for side B — the background side. Simultaneously pressing the "down arrow" and [ENTER] switches to side B. How do you know that you're in side B? The screen changes to the alternate text screen, the orange screen. Pressing the right arrow [ENTER] combination returns to side A with the original green screen. Both sides will show the Extended or Disk BASIC logos. But, in a disk system you can shut the Disk BASIC ROM off and revert back to Extended BASIC — so that you can load those "awful" machine language programs whose authors insist on loading in the same memory location which Disk BASIC uses for buffers and scratch pad — without removing the Disk controller pak.

It is impossible in the space available to this review to get completely into the details of all of the *Key-264K* commands. Hopefully, the reader will get a good feel of the capability of *Key-264K* by using the table of commands. I do want to emphasize that the *Key-264K* commands become a part of either Extended or Disk BASIC and the commands are used in BASIC programs like any other BASIC command, ie, no extra control keys, *PRINT* statements or whatever. In other words, the command *SWITCH* is just as much a valid BASIC command as *PRINT*. Of course, if you write a BASIC program using *Key-264K* commands, the program will produce SN errors if *Key-264K* is not resident in the machine.

As you can see from Table I, *Key-264K* provides a number of functions not possible in RS BASIC (why didn't they think of these). Let's take a look at a few of these commands. The *PUSH* and *PULL* commands are used to "communicate" between the two memory banks. They provide a mechanism for transferring data in the form of variables between the memory banks. For example, we could load a database program on side A and store the data on side B. When the data is needed for the program, the command *PULL* will bring data from side B to side A, e.g., *PULL A\$(25)*. After modifying the record we could then *PUSH A\$(25)* back to side B. Of course *A\$* must be properly dimensioned on both sides. An alternative to using a memory bank for data storage is to use it for the storage of subroutines. To call a subroutine on side B from the main program on side A, the *SWITCH* statement is used. At the point in the main program where one would usually place a *GOSUB* statement, simply place a *SWITCH* statement, e.g., *SWITCH 100*. Execution of this statement would cause transfer to side B and begin execution of line 100. At the end of the subroutine instead of the usual *RETURN* statement another *SWITCH* statement with the appropriate line number in side A would result in a switch back to side A.

Another very useful command is *VIEW* which has a number of options — too numerous to mention here. *VIEW* allows the user to place either the text or graphics screens of either side on the monitor. It is sort of a super *SCREEN* command in that it can be executed in direct mode to place a graphics screen on the monitor. For example, *VIEWAG* causes the graphics screen on side A to be placed on the monitor. To do this with *SCREEN* you would need the following code:

```
10 SCREEN 1,0
20 GOTO 20
```

As you can see, *VIEW* is a lot easier. To look at the graphics screen on side B, simply use *VIEWBG*. The *VIEW*

## GRAPHIC MATH ADVENTURE \$21.95 FASTER & BETTER

Challenging Adventure! Fully player selectable up to 300 "rooms." Search for treasure on land, on river, and in the labyrinth of caves. Your search is blocked by many obstacles which can be overcome by correctly answering math problems. Any one or all four functions (+, x, -, /) can be selected to add variety. 24 skill levels make the game challenging for all ages. 32K EXT BASIC Required. Version 1.2 NOW AVAILABLE

## BACKUP MASTER/ GRAPHIC MONITOR \$29.95

SUPER powerful UTILITY allows backups to be made of most programs — cassette, disk, even ROM based!!

- Over rides all software autostart mechanisms
- Fully relocatable — will not interfere with any program
- Capable of reading many tapes which BASIC can't

64K USERS have extra power

- Modify BASIC to suit your needs
- Save copies of BASIC, EXT BASIC, Disk BASIC, etc.
- Run address dependent ROMS from RAM



Also:

### SPELLING MASTER \$14.95 MATH MASTER \$14.95 for both

Conquer spelling. Learn the words you have trouble with. User input unlimited number of words. Good for weekly spelling lists. SAMPLE list provided. 16K EXT BASIC cassette

Learn Basic Math Facts (+, x, -, /) and counting routines. Math drill for speed. Math tutor teaches with graphics. MATH DRILL Non-EXT BASIC \$8.95. MATH TUTOR 16K EXT BASIC \$8.95

### CONCENTRATION \$6.95

40 blocks hide 20 patterns. Pit your memory skills against your friends. Two players. Non-EXT BASIC cassette.

### 15% off ALL "SPECTRAL ASSOCIATES" SOFTWARE

LANCER	<del>24.95</del>	21.20	GAME PAC III	<del>12.00</del>	15.25
STORM ARROWS	<del>24.95</del>	21.20	PICKWHICH	<del>12.00</del>	11.00
WHIRLYBIRD RUN	<del>24.95</del>	21.20	SPACE CHESS	<del>12.00</del>	15.25
CUBIX	<del>24.95</del>	21.20	KEYS OF THE WIZARD	<del>22.00</del>	18.65
ALPHA SEARCH	<del>10.95</del>	16.95	LOTHARS LABRYNTH	<del>12.00</del>	15.25
MS GOBBLER	<del>24.95</del>	21.20	LEMANS	<del>12.00</del>	15.25
GHOST GOBBLER	<del>22.95</del>	20.35	COLOROUT	<del>12.00</del>	11.00
SPACE SENTRY	<del>10.95</del>	16.10	CCTHELLO	<del>12.00</del>	15.25
TRILOGY	<del>62.95</del>	45.00	COSMIC SUPER BOWL	<del>12.00</del>	15.25
COLOR COSMIC INVADERS	<del>30.95</del>	17.80	SPACE TRADERS	<del>12.00</del>	15.25
SPACE RACE	<del>24.95</del>	21.20	YAHTCC	<del>11.00</del>	10.15
SPACE WAR	<del>24.95</del>	21.20	ALCATRAZ II	<del>11.00</del>	10.15
GALAX ATTAX	<del>24.00</del>	21.20	GEOGRAPHY PAC	<del>24.00</del>	29.70
DEFENSE	<del>24.95</del>	21.20	TYPING TUTOR	<del>22.00</del>	20.35
PLANET INVASION	<del>24.95</del>	21.20	FLEXPLUS DOS	<del>22.00</del>	62.00
PIGGY	<del>12.95</del>	11.00	ULTRA 80C	<del>52.00</del>	45.00
COLORZAP	<del>12.95</del>	15.25	COMPUVOICE	<del>22.00</del>	32.25
DESERT GOLF	<del>14.95</del>	10.15	SOUNDSOURCE	<del>22.00</del>	23.75
C-TREK	<del>14.95</del>	10.15	GRAPHICS 'N TEXT	<del>22.00</del>	20.35
GAME PAC I	<del>12.95</del>	15.25	DISASSEMBLER	<del>12.00</del>	15.35
GAME PAC II	<del>12.95</del>	11.00			

### Gameboard Pac \$6.95

Contains three hi-res gameboards: checkers, Othello and Pentii.

### PROGRAMMERS —

We pay highest royalties — write for details.



### Software Factory

1333 Morgan Road  
Bremerton, WA 98312  
(206) 377-1694



Dealer & Author inquiries invited

WRITE FOR FREE CATALOG  
Add \$3 Shipping — No COD

command is not limited to graphics screens either. VIEWAT places the standard text screen of side A on the monitor while VIEWBT places the B side text screen. With the VIEW command you can monitor what is happening on either side without switching sides.

The combination of VIEW with the two block memory move commands (MCOPY and CMCOPY) allows a programmer to use up to six graphics screens, e.g., the standard two on side A and storage of four additional screens on side B. The following brief code illustrates one approach:

```
1 GOTO 10
5 FOR I=1 TO 5000: NEXT: RETURN
10 VIEWAG: GOSUB 5
15 CMCOPYF 9728, 15871 TO 3584: GOSUB 5
20 MCOPY 9728, 15871 TO 3584: GOSUB 5 etc.
```

In this example we'll start by viewing the graphic screen on side A and moving blocks of memory which contain the graphics to the graphics screen on side A. Subroutine 5 is a standard pause subroutine. The CMCOPY command provides cross bank copying capability. In line 15 CMCOPY will copy a block of memory beginning at 9728 through 15871 from side B to side A and place it at 3584 which is the start of the standard graphics screen which VIEW is presently set to. To move the current graphics screen back to where we just copied from (side B), we could insert line 17: 17 CMCOPYT 3584, 9727 TO 9728.

In line 20 we use the MCOPY command to move a graphics screen on the same side in which our program is running into the graphics screen which VIEW is set too. I'm sure most of you do not intend to move graphics screens around; however, this example serves as a good illustration of these two powerful block memory copy commands which serve a number of useful needs.

One of the major attractions to *Key-264K* is the capability to perform multi-tasking. To my knowledge, only OS-9 has this capability. So, just what is multi-tasking? Very simply, it is the ability of the computer to execute several programs at the same time. With *Key-264K* we can load a program into each memory bank and run them simultaneously. As an example, I loaded my favorite database program into side B, the background side, set up the report format and started printing my report. I then switched to side A, the foreground, entered the command MTON to initiate multi-tasking and loaded my favorite game. I must say, it as a strange feeling having full control of the computer which the printer chugged away. Now for this capability something has to give. Because CoCo must spend half its time with bank A and half with bank B, both the game and printer were noticeably slower. However, neither was slow enough to be a problem. At least I got something accomplished, if only playing a game, which I lost, while the printer was in operation.

To carry this process one step further, I decided to load my favorite word processor, *Telewriter*, into side B so that I could print a long document while working on something else. It was a great idea — while it lasted. After *Telewriter* loaded — no more *Key-264K*. *Telewriter* had reconfigured the computer to map I. I don't mean to imply a defect in *Key-264K*. rather, the user should be aware that not all programs, particularly machine language programs, will run with *Key-264K*, ie, each program will have to be tested.

While *Key-264K* provides additional capability for BASIC programming, it is also very useful for debugging BASIC programs. Using the [\] command you can test a small block

of code in the background or with the LCOPY command send a copy of the program to the other side where you can test modifications without destroying the original which is on the other side. The LCOPY command has the same syntax as LIST and has the same options except that it "lists" BASIC lines to the opposite side.

With these few examples I have discussed and tabled, you should have reached the same conclusion that I have. *Key-264K* is an excellent utility which adds additional flexibility to BASIC programming. The program can best be described as an extension to BASIC. Just as most of you have added Extended and Disk BASIC to Color BASIC, so some of you may wish to add *Key-264-K*. I highly recommend it.

(Key Color Software, P.O. Box 360, Harvard, MA. 01451, tape \$39.95, disk \$44.95)

TABLE I  
KEY-264K COMMANDS

COMMAND	FUNCTION
\	The backslash command is used to initiate tasks in the background in the multi-tasking mode from the foreground side.
CMCOPY	Copies the contents of a block of memory either to or from specified memory locations on the opposite side.
CPEEK	To return the contents of a memory location on the opposite side.
CPOKE	To change the contents of a memory location on the opposite side.
CRUN	To switch to the opposite side and place the opposite side in run mode.
DUP	To make an exact duplicate of the current side to the opposite side.
LCOPY	To copy one or more BASIC program lines from the current side to the opposite side.
MCOPY	To copy a block memory from one location to another on the same side.
MTON	To initiate the multi-tasking option.
MTPAUSE	To provide a temporary halt to multi-tasking.
PULL	To copy a variable from the opposite side to the current side.
PUSH	To copy a variable from the current side to the opposite side.
SCOLOR	To switch the text screen color.
SWITCH	To switch to the opposite side.
VIEW	To display text or graphics screens of either side from either side.
WAIT	To provide a pause in foreground processing until the background job ends or requests keyboard input.

# SELECTED SOFTWARE

FOR THE COLOR COMPUTER

## HARDWARE DISCOUNTS:

TAKE 10% OFF THE PRICE OF TWO OR 15% OFF THE PRICE OF 5 OR MORE!

### UPGRADE YOUR COLOR COMPUTER!

Complete solderless kits with easy-to-follow instructions.

4K-16K For All Boards	\$15.95
4K-32K For All Boards	\$49.95
16K-32K For All Boards	\$34.95
64K For E & F Boards Only	\$54.95

\*IF POSSIBLE, PLEASE SPECIFY BOARD REVISION WITH ORDER.

#### 64K CHIP SET

Eight 4164-200 NS Prime ICs for your own use \$51.95

Note: All ICs used in our kits are first quality 200NS Prime Chips and carry one full year warranty.

**NEW**

### COLORWARE VOICE SYNTHESIZER

WITH VOTRAX CHIP READY TO PLUG IN AND TALK. COMES WITH SOFTWARE ON CASSETTE AND USER'S MANUAL.

\$59.95

## SOFTWARE DISCOUNTS

TAKE 10% OFF THE PRICE OF ONE, 15% OFF THE PRICE OF TWO OR 20% OFF THE PRICE OF 5 OR MORE!

All programs are in 16K machine language on tape unless noted.

### TOM MIX SOFTWARE

* BUZZARD BAIT (32K) Just outstanding!	\$25.95
* DONKEY KING (32K) Just outstanding!	\$21.95
* KATERPILLAR Excellent graphics.	\$19.95
* TRAP FALL Just like Pitfalls.	\$24.95
* WAR KINGS Old favorite.	\$15.95
* PROTECTORS (32K) Excellent graphics.	\$24.95

### SPECTRAL ASSOCIATES

* LANCER (32K) Excellent Joust-type game.	\$21.95
* ANDROID ATTACK Comes with 16K and 32K. 32K version will talk.	\$21.95
* MS. GOBBLER (32K) Outstanding with 4 different mazes and 16 skill levels.	\$21.95
* WHIRLYBIRD RUN Drop bombs and fire missiles to destroy enemy bases, ships and missiles over a varying terrain.	\$21.95
* GALAX ATTAX Protect your base by shooting alien fighter in formation.	\$19.95
* PLANET INVASION Excellent Defender game.	\$19.95
* DEFENSE Strikingly good.	\$19.95
* SPACE WAR You must break through the enemy fighters and the defenses of Death Star.	\$19.95
** SPACE INVADERS Still the best.	\$17.95
* GHOST GOBBLER Highly rated Pac Man type game. 16 skill levels and lots of action.	\$19.95

### MED SYSTEMS

INVADER'S REVENGE You are the last survived space invader. You must revenge!	\$19.95
PHANTOM SLAYER Enter the deadly catacombs and destroy the phantoms. 3-D graphics.	\$19.95

### INTRACOLOR

** COLORPEDE Just like the arcade.	\$25.95
* ROBOTACK Just like the arcade.	\$21.95

### THE PROGRAMMER'S GUILD

** NINJA WARRIOR The ultimate arcade challenge.	\$29.95
** PACDROIDS Super challenging!	\$19.95

### RAINBOW CONNECTION SOFTWARE

RAINBOW WRITER The ultimate in high resolution graphics text display. 12 sizes up to 64x24 for 16K, 32K or 64K machines. The 64K selection automatically transfers all ROM to RAM. Requires extended BASIC.	TAPE \$29.95
	DISK \$32.95

### DATA SOFT

* ZAXXON (32K) Maneuver your ship through a battlefield of state-of-the-art missiles, anti-aircraft tanks and enemy planes. Survive all that and you'll meet the deadly ZAXXON Robot!	\$39.95
** MOON SHUTTLE Pilot your moon shuttle through outerspace avoiding man-o-wars, meteors, bomb launchers and expandos to meet the prince of darkness. But watch out for his darkest side.	\$29.95

### COMPUTERWARE

* JUNIOR'S REVENGE (32K) Climb vines avoid obstacles & creatures to save your Father from Luigi.	\$26.95
* GRAN PRIX (32K) Race against the clock and challenge the Mario Andretti in your soul.	\$21.95
* DOODLE BUG Just like Ladybug.	\$21.95

### THE CORNSOFT GROUP

** FROGGER Sega's official version.	\$19.95
-------------------------------------	---------

### ELITE SOFTWARE

* ZAKSUND (32K) Fly your spaceship through enemy star bases. Avoid guided missiles, lasers and firing turrets. Can you reach their leader?	\$24.95
--	---------

### SOFT SECTOR MARKETING

MASTER CONTROL II Comes with plastic key-board overlay and easy to understand manual.	\$17.95
COLOR GRAPHIC EDITOR This program permits the creation of graphic pictures on the screen that can be saved to disk for later use. Requires extended BASIC or DISK BASIC.	\$17.95
* COLOR CATERPILLAR Excellent graphics.	\$17.95
COLOR BONANZA 50 programs on 6 cassettes. Some require extended BASIC.	\$39.95

### SUGAR SOFTWARE

#### Extended BASIC Programs

TIMS Excellent personal database management system.	\$24.95
GALACTIC-HANGMAN Rated A +	\$17.95

### MARK DATA PRODUCTS

** SPACE RAIDERS New Invader-type game.	\$21.95
* ASTRO BLAST Excellent space game.	\$21.95
* COLOR HAYWIRE Rated A +	\$19.95

Please note: Software and hardware cannot be mixed for discount.

\* Requires Joystick \*\* Joystick Optional

We pay postage on all orders in the United States and Canada. Overseas please add \$3.00. (MN Residents add 6% sales tax.)

We accept check or money order. U.S. funds only for foreign orders.

Send to: SELECTED SOFTWARE, P.O. Box 32228, Fridley, MN 55432

## RubiconII — Patton Would Have Loved It

I have been a games player for many years. I play everything from chess to poker and blackjack, and all types of war games from board games to miniatures. I also have learned to love the Color Computer for all of the great graphics possibilities and the use of one of the best BASICs available. The one thing that the Apple and the Atari have had over us is the availability of true, full-featured war games. We have come of age with *RubiconII*. At last we have a game which will actually give the feel of a real battle situation.

What do I mean by the feel of a real battle situation? A really good war game will give you some of the fear of war. You get to see some things about people that you may or may not wish to know. Many people think that it is not possible to simulate the war in a game because nobody can get hurt. If the game is good, this is not true. I played in a war game tournament several months ago at West Point Mil-

itary Academy. I was on the "US" team playing against the "Russian" team. In most such games of modern warfare, the object is for the "US" team to defend and have all of the massive "Russian" team jump on them and try to dislodge the "US" material. You get to learn what Custer must have felt like. Knowing a little about one of the "Russian" players, I told the "US" team during the pre-game briefing a little of how the actual Russian battle plan works. A few fast moving units go rapidly through town trying to draw fire. If they do, the massive Russian tanks sit off and blow the buildings away. The way to fight this is you must sit hidden and let the first units go through. Then you destroy the tanks at close range when they advance.

The way it actually happened was our right flank commander saw all the "Russians" in the world coming down on him. He panicked and fired at long range at a few motorcycles and armored cars. When the smoke cleared, the town and our right flank were no more.

The game *RubiconII* has all of the feel of this. In *RubiconII*, you play the American side and the computer plays the German side. You must cross the Rubicon (the Rhine?) and destroy several German cities and an airfield. The Germans are outnumbered and have several of their units under strength. The German side, however, is hidden and you are not. The American side must cross the river, advance against hidden forces, and maintain supply lines.

The game is played as a board game in Lo-Res because of the memory requirements. There is, however, a very good and clear map that is used. I have played the 16K version of this game and find this one much more effective. The unit types are indicated by logical letters indicating their type. The computer does all of the bookkeeping for you, telling the number of the unit, the strength, and the supply factor. This is excellent.

Many World War II unit types are used in this game. You have infantry units (some with mortars), heavy tank, tactical air, recon tank, artillery, and supply units. Don't forget these last (as I did). If your units go out of supply they cannot move and are quickly lost. One of my losses in this game came because I failed to protect my supply units. It also is possible to have parachute drops of units into the battle. For the sake of several of my units, I wish I could also have dropped supplies. Artillery is rather powerful in this game — possibly a little more powerful than in actual World War II action. But one good (and frustrating) feature is that you do not have the use of artillery any time you want it. As in actual battle situations, it is possible for the artillery to be involved in supporting other battles and not be available to you when needed.

The other side of the coin to panic in a real war game situation is the "blood lust" — the old "damn the torpedos, full speed ahead." Many great acts of heroism and stupidity in war (the difference between these depending on the result, not the relative bravery) is due to this. During *RubiconII* this feeling may come at the wrong time. In the game where I did not protect my supply lines, I was rampant to kill the evil foe and do it *now*. One hidden enemy unit was bypassed and came to light behind my lines to destroy my supply unit. Then came the "panic" I mentioned before, as my units were cut to pieces while out of supply.

A true war situation combines the need for both tactics and strategy. I might define the way I use these words. Strategy is the combination of everything that is done before each battle to get your side ready for the battle. Tactics is the actual conduct of the units during the actual battle. *Rubi-*

TRS-80+ MOD I, III, COCO, TI99/4a  
TIMEX 1000, OSBORNE, others

### GOLD PLUG - 80

Eliminate disk reboots and data loss due to oxidized contacts at the card edge connectors. **GOLD PLUG 80** solders to the board edge connector. Use your existing cables. (if gold plated)



COCO Disk Module (2)	\$16.95
Ground tab extensions	INCL
Disk Drives (all R.S.)	\$7.95
Gold Disk Cable 2 Drive	29.95
Four Drive Cable	39.95

USA shipping \$1.45      Can/Mex \$4.  
Foreign \$7.      Don't wait any longer      TEXAS 5% TAX

Available at your favorite dealer or order direct from

 **E.A.P. CO.**   
P.O. BOX 14  
KELLER, TEXAS 76248  
(817) 498-4242      MC/VISA  
+ trademark Tandy Corp



## Face Maker 'Speaks' To The Young

*conII* has both of these aspects well employed. The tactical problems are clear cut and the success of your separate battles involves the movement and placement of pieces. Your strategic problems include the need to supply units, the use of reserves, and the object of the game itself. Remember to read the rules. Your object is not to destroy as much of the enemy as possible. You have specific strategic objectives in this game and your victory score depends on how well you achieve these goals.

The documentation of *RubiconII* is much better than average. It consists of an eight-page booklet and is done on a reasonable printer. As with most good games, the rules are a little complicated, so read carefully. As I have already stated, if you want to win, look at the victory conditions.

In warfare, one of the basic principles is to bring maximum force to one point of conflict in order to gain an advantage over the enemy. This is one feature that is often missed by war game designers, especially computer war game designers. If one unit must always face one unit and the other units are not figured into the action, the use of the greater force against one point in the enemy line is not felt. I consider it a significant flaw if two or three units cannot jump on one enemy unit. Although you may miss the feature in *RubiconII* at first glance, this flaw is avoided in a rather subtle and clever fashion. When units are "full strength" and able to take care of themselves, they fight one-on-one. When several of your units become "understrength," you can move them to one location and join them with the *MERGE* command. Although this is not a "perfect" solution, it is a very good one and one that does not take much memory away from the game.

Another nice feature of the game is the possibility to save games during the play. This will allow you to continue the game later or to try several solutions to a given situation. The game takes about three and a half hours to play.

I have a few suggestions to make for the faster play of the game. If your computer will take the high speed poke, add *POKE65495,0* to the first line. You must also add: *POKE65494,0* to line 4780 to slow the computer down for the *SAVE* feature.

The cassette and the disk version are both on the tape. If you have the disk version, save to disk and make the two above changes. Then make and save the following program (I called it *STARTER: 110 POKE25,14: POKE3584,0: RUN"RUBII."* This makes the proper *CLEAR0* for disk and allows a quick startup with just *RUN"STARTER."*

There are now several ways to get 64K from the CoCo, both using the upper RAM for data in BASIC and from OS-9. One of the reasons for more good war games with the Apple and Atari are the use of 48K. I would expect the future to bring even better war games for the CoCo. For the present, *RubiconII* is one of the best — if not *the* best — war games available for my machine.

If you think I liked this game, you are right. The game is by Ark Royal Games. A friend of mine has corresponded with them about one of their previous games and has found their customer relations excellent. I suggest you get this game and go to war against CoCo. At the low levels I can win; at the highest levels, Patton might not be able to.

(Ark Royal Games, P.O. Box 14806, Jacksonville, FL 32238, 32K ECB, tape \$24.95 [loadable to disk], disk \$27.95)

— Tom Roginski, Ph.D

*Face* is a family game with a simple but entertaining format. It talks! After you have loaded and executed the program, a man's face is screened, along with the words "eyes," "ears," "nose," "mouth," and "hair." A red cursor passes each word. If you press any key (including [BREAK]) when the cursor is opposite "nose," for example, you hear a computerized voice say "nose" and get a menu of different noses. Selecting one of these shows the face with its new nose. This simple keyboard response makes the program suitable for toddlers and handicapped youngsters.

My two children, ages six and three, enjoyed the game and the novelty of hearing our CoCo speak. I felt it was a lot of code (12K) for five words, code that might have been used for more features. The kids agreed. One son wanted to change the style and color of the bow tie under the face; the other thought "no hair" should be a choice. All the features (except for the bow tie) are red. Better use could be made of color—the eyes could have been blue or green, for example.

Still, we had a lot of fun "making faces." I'm a former psychologist and family counselor, and I found that *Face* lends itself beautifully to parent-child interaction. Sit your youngster(s) on your lap and invent your own games. Here are some of our favorites:

- Observation skills: "Close your eyes while I push a key. Okay, look—what did I change?"
- Sharing opinions: "Which one do you think is funniest?"
- Sharing feelings: "Can we make him look happy? Sad? Angry? Surprised? (How can you tell people's feelings from the way they look?)"
- Cooperation: "Let's take turns. But I get to do the eyes!" (this one from my six-year-old)
- Exploration: "If I could do it fast enough, could I make him blink his eyes?"

The program is aimed at youngsters ages one to five years old.

The packaging is simple but adequate. I liked that because it helps keep the price down. The documentation is also simple, the kind of step-by-step instructions that all software should have. Both saves loaded on the first try.

Since my computer is on loan once a week to the special education class at the high school where I teach, I had the group take a look at *Face*. Even these teen-aged videogame sophisticates were amused. One girl made this assessment: "My little brother would love this!"

You know, I'll bet he would.

(Childish Software, P.O. Box 985, Norcross, GA 30071, 16K tape \$21.95)

—T. Gray

## Spelling Is D-e-l-i-c-i-o-u-s With *Cookie Monster's Letter Crunch*

Big Bird, Oscar the Grouch, Cookie Monster; what do all these names have in common? Stumped? Ask any little child, or maybe not so little, and you will find out that these are the names of characters on a very popular educational TV series called "Sesame Street."

"Children's Computer Workshop," an activity of "Children's Television Workshop," which presents "Sesame Street," has again demonstrated its expertise in children's education by introducing a series of learning programs for the CoCo!

One of these programs is entitled *Cookie Monster's Letter Crunch*. The 16-page documentation that accompanies this 16K ECB cassette program is excellent. It begins by instructing you how to set up your computer, and successfully load in the program. This part may seem "old hat" to some of you, but this just demonstrates the care that was taken in writing the manual. The object of these games, or I should say educational activities, is to match up letters or words. By doing this correctly, you proceed to bake the letter or word in an oven that transforms it into Cookie

Monster's favorite food . . . *cookies*, of course!

After a well-done graphics screen is displayed, the first menu appears. On this menu you have four main activities to choose from. After you choose, the next screen offers you the choice of using a predetermined word list or the option to create your own. The next menu is the skill level at which you wish to play. There are six levels of increasing difficulty. Choosing a level above two will display words instead of letters in the oven. The four main selections include a matching activity, a matching and memory activity, a timed matching game, and a timed memory and match game. Pressing the [CLEAR] key at any time will end the present activity and return you to the main menu.

It is recommended that you start with the first one, "EASY BAKE," the matching activity, and at the first level of difficulty. The object of this activity is to match the letter that appears in the baking oven at the top of the screen, to the correct letter appearing on the bottom of the screen. You do this by means of the joystick. By moving the joystick left or right, you will also be moving the Cookie Monster. You must move him over the letter that you think matches the letter that is in the oven. After you make your selection, press the joystick button. If you are correct the letter drops down into a tube that carries the letter to the oven for baking. As it bakes, the Cookie Monster rushes over to the oven, jumping up and down in anticipation, waiting for his reward. After a brief moment, a cookie drops down from the oven into the eagerly waiting hands of the Cookie Monster. He then hastily eats the cookie. A wrong answer simply returns a tone and then proceeds to give you another try.

The next activity is "BAKE AWAY," which is essentially the same as "EASY BAKE" except that the letter or word that appears in the oven for you to match only stays visible for a brief moment before it disappears. You have to remember what was in the oven; however, pressing the spacebar will allow the letter or word to be displayed again.

"CHIP CHASE," the third activity, again is essentially the same as the others, except that the letters, which appear on the bottom of the screen under the Cookie Monster, are now moving around. You have to be quick to match the correct letter. A timer is also added in to pace this activity.

The last entry is entitled "CHIPS AWAY." This activity is similar to CHIP CHASE; however, this time you really have to keep your eyes open. The letter or word in the oven -- the one you have to match -- will disappear as in "BAKE AWAY," but the letters below Cookie Monster are moving around, too. Add back the timer, and you really have to keep on your toes.

Throughout the documentation there are numerous suggested guidelines that will assist you in getting the most benefits from these programs. Also included, in the last pages, are suggested activities you can play with this series of programs. After introducing this program to my children, ages 6, 5, 3 and 1, I have found it very difficult to try to turn on the TV without hearing a request to play "The Cookie Monster Game." Knowing the reputation that the Children's Television Workshop has attained, I would not hesitate to recommend this program to those who have small children in their home. At \$19.95, it's a real bargain.

(Radio Shack Stores nationwide, tape \$19.95)

—Theodore Hasenstaub

### EPROM / EEPROM PROGRAMMER FOR COLOR COMPUTER

- .... Programs up to 4 type 48016 EEPROMs or 4 type 2716 EPROMs.
- .... Functions as an 8K ROM board.
- .... Same-socket operation of programming and ROM board modes.
- .... On board voltage converter eliminates need for separate power supply.
- .... Complete user-friendly software provides PROM transferring, programming, and verifying capabilities.
- .... Reconfigurable ports allow use with many hardware peripherals, including the Radio Shack DOS.

Please specify disk or cassette and send \$135.00 Check or Money Order, or \$140.00 Visa, Mastercard or C.O.D. to:

**P & M ELECTRONICS**  
1716 North 20th Ave.  
Pensacola, Florida 32503

Inquiries welcome!

# Quality Software Is The Number One Priority At K & K COMPUTORS



**LASER TANK** - Pit yourself in a game of strategy and excitement against the computer. You must defend your flag from attacking tanks and destroy them before they destroy your flag or you!!! Only \$15<sup>95</sup>

**GAZON** - The deadly Gazonians are trying to steal your supplies and you must stop them at all costs. Similar to the popular "RIPOFF" Arcade Game, this game has color and is faster. Machine language. Only \$19<sup>95</sup>.



**MUTATRON** - As the last person alive, you must protect yourself from sadistic robots bent on killing you. Another popular Arcade Game, "ROBOTRON", brought to you by K & K. Machine language. Only \$19<sup>95</sup>.

**SHOOT TO SPELL AND FLASH MATH** - An educational package that helps kids learn to spell and educate them on elementary math. An absolute must for adults with school aged children. Only \$15<sup>95</sup>

**SPACE HARVEST** - Pilot your spacecraft above the Planetoid Voltar stealing spacefruit and trying to avoid alien guards. Machine language Only \$19<sup>95</sup>.

**SERIAL TO PARELLEL CONVERTER** - Have a printer with a parellel port? Tired of waiting for a line list? With this little hardware device you can make your color computer run at any baudrate between 300 and 9600. Let K & K help your printer to go much faster!!! Only \$67<sup>95</sup>.



**BLACKJACK** - A casino game that puts two players against the beady eyed dealer of the house. This dealer deals the cards as good or even better than Intellivision. If you have any gambling blood at all this game is a must! Same rules as any Las Vegas casino. Only \$15<sup>95</sup>.

**TAPE INDEX** - Trouble keeping track of what programs are on your tape? Now it's possible to place a directory on your cassette. Only \$15<sup>95</sup>

WE'VE CHANGED OUR NAME: FORMERLY K & K COMPUTORWARE, NOW K & K COMPUTORS.

**ALL GAME PROGRAMS** - require 16K extended (prices are set for cassette, add \$4<sup>00</sup> for disk, except business)

**PROGRAMMERS!!!** - K & K pays the highest royalties for your programs. If your program is good, send it to K & K

TRS-80 COLOR COMPUTER USERS - New programs are added each week. **SEND \$1<sup>00</sup> FOR OUR COMPLETE CATALOG**



**POLARIS** - You are under the ocean in a submarine, attacking planes and enemy destroyers dropping depth charges attempting to destroy your sub. Can you destroy them before they destroy you? This is a fast action machine language program. Only \$19<sup>95</sup>.



**SUPER ZAP** - Enemy spaceships are attacking from all sides and your mission to defend your starbase from the deadly Armada of Pyrus. This will be a dangerous mission since the Pyrus Armada has never been defeated by any humanoid. Only \$15<sup>95</sup>.

**SKY DESTROY** - Planes and helicopters are coming from all directions, they must be stopped! This game is similar to Atari's and now available to color computer users. Machine language. Only \$19<sup>95</sup>

**BOWLING SCORED FOR DOLLARS** - Do your leagues bowling averages. This program will keep individual scores, team totals, individual averages, team standings, and print all this information to your line printer. On cassette and disk, specify on order. Only \$19<sup>95</sup>.

**INVENTORY CONTROL** - This program contains all the necessary features required for all types of inventories: sort inventory by stock number, list stock number description, amount in stock, cost, wholesale, profits. Only \$49<sup>95</sup>.

**CHECK LEDGER** - This bookkeeping system allows the user to have current information on your expenses by any category you wish. Year end tax statements made easy. Disk required. Only \$49<sup>95</sup>

**ACCOUNTS PAYABLE** - Small businessmen, control your business growth by keeping track of all your cash liabilities and payment history. Only \$49<sup>95</sup>

**ACCOUNTS RECEIVABLE** - This system keeps track on the status of all customer accounts, all payment histories included. Only \$49<sup>95</sup>.

K & K COMPUTORS

P.O. BOX 833 • STERLING HEIGHTS, MICHIGAN  
48077

Telephone: (313) 264-7345

# Nobody Does It Better In Speech or Music



## THE VOICE and THE COMPOSER \$79.95

(Over a \$200 value, offer expires 1/31/84)

You get CoCo's best hardware speech synthesizer using the VOTRAX SC-01, THE VOICE (was \$119.95) plus the gift of music, THE COMPOSER (a \$24.95 value).

Included is a text to speech ML program FREE to allow any BASIC program to speak in minutes (was \$29.95).

You also get 6 education and fun programs FREE (a \$34.95 value).

You will have access to an ever growing library of software.

Disk owners don't despair, THE VOICE works in all multi-pac units including our own Y-CABLE.

You can find speech units for less and a lot for more, but you won't find any better.



	Speech Systems The Original VOICE	Spectrum Projects Voice-Pak
Speech thru TV speaker	Yes	Yes
Speech thru external speaker	Yes	No
Volume control	Yes	No
Pitch control	Outside Adjust	Inside Adjust
Demo Programs	5	None
Phoneme Editor	Yes	No
Text-to-Speech program	Yes	Yes
Documentation	40 pages	9 pages
Software	2 tapes	1 tape
IC count	6	2
Case material	Aluminum	Plastic
Case size	1 <sup>5</sup> / <sub>16</sub> x 5 <sup>1</sup> / <sub>2</sub> x 4 <sup>1</sup> / <sub>4</sub>	1 <sup>5</sup> / <sub>16</sub> x 3 x 4 <sup>1</sup> / <sub>4</sub>
CoCo 2 version	Coming Soon	No
<u>Expansion Unit Compatibility</u>		
RS Multi-pak	Yes	Yes
BT-1000	Yes	No
Spectrum Switcher	Yes	No
Y-Pak	Yes	No
Y-Cable	Yes	No

NOTE: All software (except Termtalk) will work on either unit, so you can buy our software and their hardware or vice versa.



(Actual Photo)

## MUSICA

4 Notes produced simultaneously.

Input notes from keyboard or joystick.

Develop your own unique sounding instruments.

Vary tempo as music plays.

Save or load music from tape or disk.

Call music from your own BASIC program.

Music produced in stereo when used with the STEREO COMPOSER.

All features are fast because it's all machine language. It doesn't get any better than this.

Tape **\$34.95**

Disk **\$39.95**

## STEREO COMPOSER

CoCo's one and only stereo music synthesizer. Plug it into the cartridge slot, connect to external speakers or your home stereo and you're ready for music realism. Comes with the COMPOSER 4 voice software. Separate left and right channel volume controls. Two 8 bit D to A's — for perfect reproduction. May be used with our best software "MUSICA." Disk owners may use any expansion unit or our Y-CABLE.

Tape or Disk **\$69.95**

## THE COMPOSER

A 4 voice music program with 7 octave range. Plays music in any octave or key. Change tempo as music plays. Most of the features of MUSICA.

Tape (16K or 32K) **\$24.95**

Disk (32K) **\$29.95**

## THE Y-CABLE

Disk owners why pay \$100 to \$300 for a multi-pac unit. With our Y-CABLE you can connect your disk in one connector and the VOICE or STEREO COMPOSER in the other. **\$29.95**

We accept CASH, CHECK, COD, VISA, and MASTER CARD orders.

Shipping and handling US and Canada ..... \$2.00

Shipping and handling outside the US and Canada ..... \$5.00

COD charge ..... \$2.00

Illinois residents add 5 1/4% sales tax for the STEREO COMPOSER or THE VOICE.

# Speech Systems

**38W255 DEERPATH ROAD**

**BATAVIA, ILLINOIS 60510**

**(312) 879-6880 (24 HR. VOICE)**

**(312) 879-6811 (24 HR. BBS)**

CALL ANY DAY, ANYTIME TO ORDER. ALSO ORDER BY MAIL OR BBS.  
WE SHIP FROM STOCK WITHIN 48 HOURS.

\$100 awarded for the best talking program for education, the handicapped, home security or other serious application.

Another \$100 for the best entertainment talking program.

Contest winners and other program authors will be offered a contract with generous royalties. Contest ends 5/31/84.



### SPECIAL INVITATION

To our friends who did not want the extra features and flexibility of the Speech Systems Voice and purchased the Spectrum Projects Voice-Pak, please be advised that your programs will work with our speech synthesizer and we will gladly accept your contest entry.

*All Programs for the original Speech Systems Voice or Spectrum Projects Voice-Pak \**

### TERMTALK (Smart)

The first smart talking terminal program. All the features of an intelligent telecommunications program plus what appears on the TV is spoken just like in the movie WAR GAMES.

Tape **\$39.95** Disk **\$49.95**



### FINAL COUNTDOWN

You must stop the mad general from launching a missile at Moscow and causing WW III. Has multiple voices for added realism.

Tape (32K Ext) **\$24.95**

### TERMTALK (Dumb)

Has most of the features of the Smart version. Allows easy communication with BBS and talks. Uploading and downloading not supported.

Tape **\$24.95** Disk **\$29.95**



### ESTHER

Meet Esther the talking psychoanalyst. An excellent example of artificial intelligence. She may not solve all your problems, but her insight will amaze you.

Tape (32K) **\$24.95**



### PRESIDENTS

An educational game that will sharpen your knowledge of the U.S. Presidents.

Tape (32K) **\$9.95**



### SPECIAL OFFER

Speech Systems believes Termtalk can be of particular use to those with a sighting impairment. We are currently trying to develop a nationwide network to allow such handicapped persons to telecommunicate. Anyone purchasing Termtalk for this application will receive a \$5.00 discount.

### COLOR MATH

The perfect educational game to aid the student in learning addition, subtraction, multiplication and division. Allows one to specify difficulty level.

Tape (32K Ext) **\$28.95**

### SPELL-A-TRON

The program allows the user to build a dictionary of words. During testing, the words are spoken. If an incorrect response is given, the word is spoken again and spelled.

Tape (32K Ext) **\$28.95**

### SCORE E-Z

A yahtzee type program. Up to six players can compete. All scoring and recordkeeping is done by the computer.

Tape (32K Ext) **\$24.95**

\* Termtalk requires the Speech Systems Voice

### More Talking Software

<b>CAPITALS</b> (What's the capital of New Hampshire) .....	\$9.95
<b>STATES</b> (Makes learning the states fun) .....	\$9.95
<b>HANGMAN</b> (Guess the word before you hang) .....	\$9.95
<b>MATH DRILL</b> (Arithmetic was never so much fun) .....	\$9.95
<b>SPELLING TESTER</b> (Win your next spelling bee) .....	\$9.95
<b>FOREIGN LANGUAGES</b> (Want to learn a foreign language) ..	\$9.95
<b>POETRY CREATOR</b> (Robert Frost was never like this) .....	\$9.95
<b>SHORT STORY MAKER</b> (You've got to hear this one) .....	\$9.95

And much more to come. Don't forget the contest.

Dealer Inquiries  
Invited

If your dealer doesn't stock  
our products, ask for them.

We accept CASH, CHECK, COD, VISA, and MASTER CARD orders.  
Shipping and handling US and Canada .....\$2.00  
Shipping and handling outside the US and Canada .....\$5.00  
COD charge .....\$2.00  
Illinois residents add 5 1/2% sales tax for the STEREO COMPOSER or THE VOICE.

# Speech Systems

**38W255 DEERPATH ROAD  
BATAVIA, ILLINOIS 60510**

**(312) 879-6880 (24 HR. VOICE)  
(312) 879-6811 (24 HR. BBS)**

CALL ANY DAY, ANYTIME TO ORDER. ALSO ORDER BY MAIL OR BBS.  
WE SHIP FROM STOCK WITHIN 48 HOURS.

## Well-Conceived *Kron* 'Rates With The Best'

If you enjoyed the Walt Disney production of "Tron" and you have played the arcade version of the same movie, you will undoubtedly appreciate *Kron*, a new rapid-paced, high resolution game by Oregon Color Computer Products.

You recall that in the movie, our hero becomes trapped inside of a computer game, and for the next hour or so, he is challenged by every conceivable video game effect as he tries to make it back to the real world.

You know you have something special as the cover screen is unveiled, allowing you four optional screens of play — the silo, the spiders, the cycles and the tanks.

On the silo screen, you are trapped inside of a, yes, silo. High above, three levels of multi-colored blocks are slowly descending toward you. Using your joystick, you maneuver our hero into position to blast the blocks before they flatten him. You may aim in three different directions, but don't get too close because their touch is fatal. And don't brush up against the side of the silo, either.

The spider screen is just as challenging, featuring a couple of dozen of those eight-legged insects who are inching your way, multiplying along the way. If you are fortunate enough to rid the area of them, you must make your way into the blinking white square at the top of the screen. Careful,

though, because the entrance is small and you must plan your move carefully.

Your entrance onto the cycles screen is preceded by realistic revving sounds. You've seen this screen before if you have typed in *the Rainbow's* listings faithfully during the past couple of years. It consists of moving lines — yours and the computer's. You must outlast the computer in order to survive. Although this screen is simply conceived, it also is one of the more difficult.

If you survived this far, you're ready for the tank battle. Your tank is pitted against one driven by the computer. You must travel through a maze attempting to blow up the enemy. Careful, though, your bullets can bounce off of walls and you can shoot yourself. This allows you to shoot around corners, which in itself is fun. Head-on confrontations can be dangerous because the enemy's fire power obviously is stronger than yours. This is a fun screen and I've seen entire games devised around the concept.

A free turn is received for every 10,000 points. When an enemy is defeated, the screen does not reappear until the rest of the enemies have been conquered. After you've survived four screens, the screen select symbols reappear and the level of difficulty increases.

A pause feature is activated by pressing any key during the symbol-select phase. You may resume play the same way.

I found the high score feature a little annoying at first because, for at least your first five times through, you will have a new high score. I just started pushing buttons after a while, not worrying about correct initials. It would be a lot nicer if a high score challenge were built in — to heighten the sense of accomplishment. This really was my only problem with the game.

*Kron* is written in machine language and requires 32K.

As far as graphics, sound and challenge are concerned, this game rates with the best of them. My advice to Oregon Color Computer Systems would be to promote this gem a little harder because there's a good market for such well-conceived games.

(Oregon Color Computer Systems, P.O. Box 11468, Eugene, OR 97440, tape \$26.95, disk \$29.95)

—Charles Springer

### GAMES FOR THINKERS



**MINIFIELD (4K)** — Follow the clues of your mine detector to find your way safely through the minefield. 10 levels of play. Tough! G12 — 7.29

**WALL STREET (16K)** — Buy and sell stocks to make your fortune! 1-4 players. Stock & market, history charts. Many extras! Good family fun! G12 — 12.71



**BABYLON (16K)** — Govern the ancient city of Babylon. Manage the City's assets and military to contend with enemy invasion, poor crops, plague, and other disasters. 10 levels of play! Tournament scoring! G13 — 12.50

### MATHEMATICS

**ELECTRONIC GRAPH (16K Ext)** — Graph any function using low, medium, or high resolution graphics. Overlay several functions! No recoding, functions entered directly! Print results on your LPVii or similar printer. M11 — 14.56

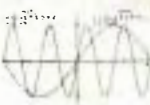

### SENTINEL DISKETTES

Guaranteed when properly used to Read, Write Error-free as long as you own them!



SS/DD 10 pack D10 — 27.50  
DS/DD 10 pack D20 — 37.00

Add \$2.00 shipping costs. Clubs, inquire about quantity discounts.

We pay shipping on programs. Washington residents add 7.8% sales tax.

No C.O.D. or Credit.



Personal checks welcome!



Valhalla Enterprises

Dept. RB14  
P.O. Box 243  
Sumner, WA 98390

## Upcoming RAINBOWfests

**RAINBOWfest** — Long Beach

DATES: Feb. 17 — 19, 1984

HOTEL: Hyatt Regency, Long Beach

ROOMS: \$59 per night single/double

KEYNOTE: Bob Albrecht

Advance Ticket Deadline: Feb. 13, 1984

\*\*\*

**RAINBOWfest** — New Brunswick, N.J.

DATES: March 30 — April 1

HOTEL: Hyatt Regency, New Brunswick

ROOMS: \$59 per night single/double

KEYNOTE: To Be Announced

Advance Ticket Deadline: March 23, 1984

**SALE  
PRICED**

# Z-PAK™ CARTRIDGE \$29.95

If You Order Two of the Following Packages with it. If Ordered Separately \$79.95

Z-Pak is an 8" x 4" cartridge that plugs into the expansion port of the CC. Z-Pak is capable of holding up to 80k or EPROM (must be factory installed). THAT'S RIGHT as firmware packages become available and are ordered, they become part of random access memory. **All on line at the same time!**

Now lets do a little addition, if you have 64k of ram and X-Basic then Z-Pak gives you the potential of having a 160k system someday... **That's approximately what a disk holds!**

Imagine... having a C compiler, a hi-res screen editor, an assembler, and two debuggers all on line at the same time!... and there's more to come!

**FOR  
OS-9  
OR  
DOS  
OR  
Non-Disk**

OS9 Users... are you finding out that 64K isn't that much when you start filling it with a hi-res screen, a compiler and a good screen editor... not to mention the OS overhead?! **Z-Pak is the solution!**

**Z-Pak grows with you.** The programs will run on a 16k CC without X-Basic THRU a 64k CC with 4 disks.

**Option #1 Two Parallel Ports \$19.95**  
Includes firmware & cable diagram for driving MX-70.

**Option #2 Disk Expansion Capability \$19.95**  
Includes firmware & hardware to allow RS controller to 'piggy back' the Z-Pak.

## INTERACTIVE-E™ PACKAGE \$39.95

IE™ is a high resolution screen oriented editor, just a few of the features are:

- ★ cursor commands
- ★ block moves
- ★ search & replace
- ★ auto insert
- ★ 64 character lines
- ★ and more...

**Option #4 Reference Card For OS9 \$5.95**

**Option #5 Screen Driver For OS9 \$9.95**

**Option #6 OS9 / CC Disk Xfer Utility \$9.95**

**Option #7 IE Reference Card \$4.95**

## INTERACTIVE-C™ PACKAGE \$44.95

Interactive-C is the next generation in compiler technology. **Imagine...** you only recompile the functions that you're working on. Everything else is AUTOMATIC and done in **one pass.**

- ★ preprocessing
- ★ parsing
- ★ lexical analysis
- ★ expression evaluation
- ★ code generation (no assembler needed... IC compiles to an extremely efficient Z-Code™)
- ★ dynamic cross checking (ever redefine a variable but missed recompiling a function referencing it?)
- ★ dynamic linking
- ★ dynamic loading (for testing)
- ★ automatically loads library modules from your library directory.

**Aren't you tired** of typing (and **waiting** for) assembler and linker commands (and the three extra passes they require!)? We haven't found a 'professional' level, C development system that is better than this.

Quite simply, with the exception of floats & doubles, IC™ supports **the entire C programming language** as described by K & R. The FULL macros, initializers & multi-dimensional arrays really make the language... **Don't settle for less!**

**Interactive C Debug™ (Included)**

Are you debugging a higher level language at assembler level... with ICD™ you can see the variable names and watch their values change as you single step. Function trace and much, much, more...

**Two Resident Libraries (Included)**  
IC includes a RESIDENT standard i/o library & a RESIDENT standard function library.

**Option # 8 Tool Kit A Useful utilities and filters \$14.95**

**Option # 9 Resident Extended Library \$9.95**

**Option #10 IC & ICD Reference Card \$4.95**

**Option # 3 C Programming Book K & R \$19.95**

## INTERACTIVE-A™ PACKAGE \$39.95

Interactive-A is an assembler... but we must WARN you. It is NOT an ordinary assembler, there are dozens of ordinary assemblers available for the 6809, and if you don't want to change the way you program, buy one of them... **However, if you're tired of performing surgery with a butterknife... then read on...**

We took a look at the programming process and decided it was inefficient to wait for a program to re-assemble after every change, and that it was even more inefficient to patch a program, only to find out 15 minutes later that the patch was wrong.

IA™ is a very fast one pass assembler, and it ONLY reassembles and auto links the subroutine or variable that has just been changed.

We've added a few NEW features that allow the building of libraries of subroutines without the OLD PROBLEM of symbol and register conflicts, these features also facilitate recursive subroutines.

**Interactive A Debug™ (Included)**

This is a screen oriented debugger that eliminates WAITING FOR A LISTING SO THAT YOU CAN DEBUG. Just a few of the features are:

- ★ single step with disassembly
- ★ dynamic reg. display
- ★ trap, dump, blk moves
- ★ load map
- ★ crash eliminator
- ★ byte/word search
- ★ command table hook
- ★ examine modify memory
- ★ cref refs to variables
- ★ trap on variable reference

AS IAD™ has access to the assemblers tables, variables may be referenced symbolically. **You should see IAD in single step mode. It looks like a logic analyzer!**

**Option #11 Resident Misc. Subr. & I/O Library \$9.95**

**Option #12 Programming the 6809 book Z & L \$19.95**

**Option #13 IA & IAD Reference Card \$4.95**

**Option #14 Disassembler (output assemblable) \$9.95**

## NEW! DISK BASED STARTER KIT FOR OS9 \$39.95

We think that the serious programmers are already sold on Z-Pak... especially at this month's sale price. However, if you're just getting into programming and OS9, and would like to move a bit slower...

The starter kit for OS9 is disk based (NO Z-Pak) and includes:

- ★ Interactive E screen editor
- ★ OS9 / CC disk xfer utility
- ★ OS9 screen driver

If you don't have OS9 we'll be happy to place the editor on tape or RS disk for \$35.95.

Color Computer is a trademark of Tandy Corporation. MX-70 is a trademark of EPSON. OS9 is a trademark of Microware & Motorola. Z-Pak, Interactive-C, IC, Interactive-E, IE, Interactive A, IA, Z-Code, Interactive C Debug, ICD, Interactive A Debug & IAD are trademarks of Micro Tools Inc.

# MICRO TOOLS INC.

CALL DAYS OR EVENINGS 7 DAYS A WEEK

(716) 594-1088

P.O. BOX 357

NORTH CHILI, NEW YORK 14514

Terms: FOB, add \$4 shipping.  
New York residents add sales tax.  
We accept VISA, MASTERCARD and Personal checks.

Prices subject to change without notice. We reserve the right to limit quantities.

## Gorilla Banana GX-100 Printer: Both A Beauty And A Beast

By Ed Ellers

Why anybody would want to call a printer a "Gorilla Banana" is beyond me. Leading Edge Products, which distributes the Banana in this country, also markets a Gorilla 12" green-screen monitor and Elephant diskettes; they must like animal names (which makes me wonder what they would do if they introduced a personal computer). Once you get past the distinctive (to say the least) name, you'll find that the Gorilla Banana is a very economical printer for the CoCo.

The one thing that hinders the use of the Banana with the Color Computer and the MC-10 is its use of a Centronics-type *parallel* interface. To get it hooked up to the CoCo's *serial* I/O jack (where the printer is normally connected), you must use a serial-to-parallel interface unit. A number of these are available; I used a Botek Instruments CCP-1, which Spectrum Projects sells for the Banana. The CCP-1's instruction sheet tells you how to change the CoCo's "Baud rate" (the rate at which it sends characters to the printer) to a number of values ranging up to 9600 Baud (16 times as fast as the CoCo's normal 600 Baud and approaching the speed of a parallel interface). You then set the Botek's selector switch to match whatever rate you chose. (As supplied by Spectrum, the CCP-1 takes its power from the printer and does not have to be plugged into an AC outlet. If you purchase directly from Botek, the interface comes with an AC adapter which you may remove, if desired. Instructions are provided.)

The printer I received for review was *not* labeled "Gorilla Banana." It was identified simply as the "GX-100" both on the unit and in the manual. The only clue to its source was that it was labeled on the rear panel as the Leading Edge Products GX-100. I've seen this printer in local stores as well, so I think that Leading Edge was shipping the GX-100's while waiting for their customized Gorilla Banana units to come through. The printers are identical except for the color of the case; the top half of the GX-100's case is an off-white that matches the newer "fawn gray" CoCos (the bottom is dark brown) while the Gorilla Banana is dark green.

The Gorilla was originally assigned for review to a *Rainbow* staff member who is a newcomer to computers. She got the printer hooked up to her home CoCo quickly, put in the ribbon, set up the tractors and inserted some paper. The first line she printed turned out fine; but when she tried to print another line, it ended up right on top of the first. (Editor's Note: This unsettling experience happens to many CoCo owners with printers of various brands when they first try them out. The problem relates to the CoCo's use of serial I/O since printers are usually set at the factory for use with some other computers. It is not a defect. Read on.) She frantically looked through the manual to find out what was wrong, but could find no answer other than that the paper might have jammed (which it hadn't). Fearing that she had either damaged the printer or that she might wreck it trying to get it going, she brought the Gorilla back to the office; I was then assigned to review it.

When I hooked it up, I got exactly the same results that she did. At first I thought that the printer was defective; then I went through the manual looking for the switch setting instructions. On Page 11, I found the following:

"The Printer has a Printed Circuit Board (PCB) on which a dip switch is located. With turning No. 3 of the dip switch ON or OFF, the meaning of CR (0D) can be changed to either NL (0A) or DC4 (14) respectively. The dip switch is at the top center of the PCB . . . and it can be seen from the back of the printer after removing the five screws and the upper case. NOTE: Four switches are set to the "OFF" side when shipped from the factory."

From my electronics experience, I knew what a DIP switch was, and I knew that the CoCo expects the printer to automatically advance the paper after each line (it sends a carriage return but not a line feed), so I was able to set the Gorilla to match the CoCo's "protocol" (the set of control codes it uses). Since the manual is of little help in this situation, I'll give the procedure here: *Before you plug the printer into an outlet*, remove the top half of the case (three screws are under the front edge, and the other two are on the back of the unit). The DIP switch is actually four tiny white slide switches in a black housing on the circuit board, and the switches are marked 1 through 4. Flip switch 3 *on* (up) and make sure that the other three switches are *off* (down), then put the top back on.

The manual is the only thing I dislike about the Gorilla Banana, because it's apparently written for an engineer to use when designing a system that is to use the printer. It gives you all the little details about signal levels and timing (you are told for example that "Bringing the TEST\* line 'LOW' starts the self-test printing which continues until it is returned 'HIGH'.") but falls flat on its face when it comes to explaining how to make the printer work with your computer. (Leading Edge told me that they have not rewritten the manual; I think that they would do well to consider it.)

The Banana's print quality is quite good, even though it uses a rather small (5 x 7) dot matrix rather than the 7 x 9 used by many printers. Here's what it looks like:

```
This is what the Gorilla Banana's
printing looks like. As you can
see, there are NO descenders on any
letters, so such things as "j", "p"
and "q" stick up above the rest of
the text a bit.
```

This print quality is good enough for casual correspondence (although you might not want to use it to write to your uncle in Peoria who hates computers), as well as school work and even writing articles (most publications, including *the Rainbow*, will accept such typing).

The Gorilla Banana also has high resolution "bit-image" graphics capability, which lets you print individual dots in any pattern you can program. Using a special driver program (like Custom Software Engineering's GSPRB), you can print out copies of the CoCo's Hi-Res graphics. The pictures are of good quality, although the density of the dots is slightly uneven (though not any more than I've seen in



# YOUR COLOR COMPUTER JUST GOT WHEELS!

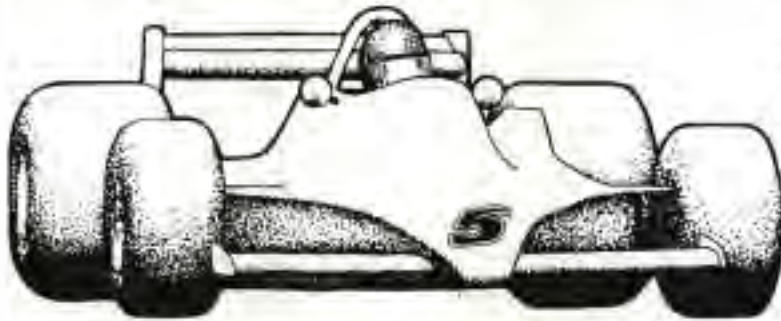

## REVOLUTION!

You accelerate hard down a long straightaway, braking heavily at the end for a hard corner. You slice smoothly through the esses, and then boldly keep the power on for a fast sweeper. The Ferrari drifts dangerously near the edge, but you make a tiny correction in the steering, and you are through.

The finish line flashes by, and suddenly you are in the pits. The car falls silent. You see your lap times being held up. Your final lap was a new lap record! At last, you permit yourself a small smile.

You have mastered this powerful car on a difficult track, driving with the assurance and precision that comes only from long hours of practice.

You are driving an authentic race car. You are playing *Revolution*!

### FANTASTIC ACTION

*Revolution* uses high resolution, machine language graphics for action that is smooth and fast. The emphasis is on authenticity in the control and motion of your car. As in driving a real race car, accuracy and precision in your driving are what counts. Frills and non-essentials have been left out.

### PURE COMPETITION

Like a real race driver in practice and qualifying sessions, you compete against the clock and against the existing lap record for that track. *Revolution* records the lap records and the name of the person who set the record, so you always know who reigns supreme on your favorite track!

### DESIGNED WITH YOU IN MIND

*Revolution* is menu-driven, and self explanatory. Information screens tell you what you need to know. When you're ready to play, a menu of the names of all your tracks is displayed, along with the lap record for each track and the name of the person who set that lap record. You select a track with a single keystroke, and *Revolution* takes you there.

### A NEW CONCEPT

*Revolution* is a unique game, because it allows you to create the most important part of any race game: the track itself.

The first time you run *Revolution*, you will be able to choose from several tracks and cars which are included with the game.

But, with *Revolution*, this is only the beginning! You can create as many tracks as you like. You can make each new track as difficult or as easy as you wish. You can make easy ones to begin with, and tougher ones as you become more skilled. You may find creating tracks to be almost as much fun as driving on them!

You can save your favorite tracks to run on again whenever you wish. *Revolution* will automatically add these new tracks to the menu. And you can exchange your favorite tracks with other *Revolution* owners.

Be careful, though, about letting your friends play this game. They may not want to let you have your computer back!

### THE EARLY REVOLUTION

A prototype version of *Revolution* was published in the September, 1982 issue of *Rainbow* magazine, under the name *The Track*. The response to *The Track* has been terrific.

*Revolution* has all the features that have made *The Track* a favorite, and *Revolution's* fast, high-resolution machine language graphics are dramatically improved over the prototype's.

### REVOLUTION NOW!

The original *Revolution* for the TRS-80™ Color Computer requires 32K and one disk drive. A new cassette version has action just like the disk version, and similar track-saving features excluding a menu of available tracks. The cassette version will run on a 32K Color Computer or TDP-100. You can upgrade to the disk version later, too, for a nominal fee.

#### REVOLUTION

For 32K Disk . . . . . \$19.95

For 32K Cassette . . . \$16.95

Requires Joysticks  
& Extended BASIC

New York residents add 7% sales tax.  
TRS-80 is a trademark of Tandy Corporation.



Inter  Action

31 Rose Court • Dept. R • Amherst, NY 14226 • (716) 839-0943



other printers).

Since the Gorilla Banana is touted as being almost identical to Radio Shack's Line Printer VII and the newer DMP-100, I borrowed a DMP-100 to compare the two. I found them to be fraternal (though not identical) twins, with identical mechanisms but different electronics. (The LP VII and DMP-100 have a built-in serial interface for the CoCo, which explains that change.) The Gorilla and Radio Shack printers have the same standard text characters (with identical patterns for every character), the same double-width mode and the same graphics characters. They use the same ribbon (R/S 26-1424) and print at the same speed. They are both made by Seikosha, whose sister companies manufacture Epson printers and computers as well as Seiko watches.

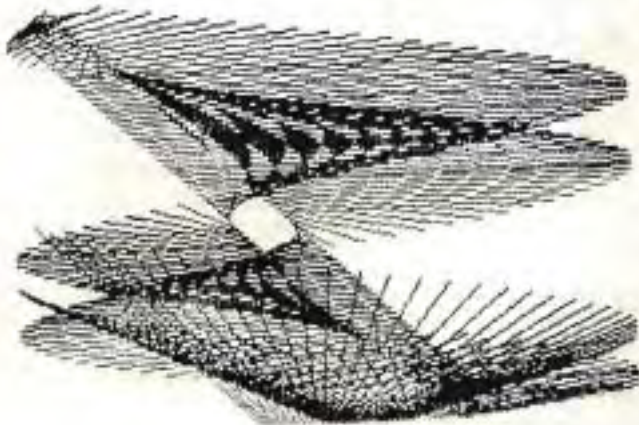

Graphic Screen Print from Gorilla Banana.

Now for the differences. First, the Gorilla Banana's case is heavier and more durable than the case that Radio Shack uses. The Gorilla also has characters for the British pound sign, the Japanese yen symbol and special German and Swedish characters. On the other hand, the DMP-100 (but not the Line Printer VII) has underlining, which the Gorilla does not have.

Although the Gorilla Banana and the Radio Shack printers are so similar in their capabilities, they use different control codes to activate their various features! This means that programs written to use the LP VII/DMP-100 special features will have to be modified to work with the Banana. Here are the codes (in decimal) that have been changed:

Function	Radio Shack	Gorilla Banana
Graphics mode on	18	8
Repeat pattern	28 22	19
Normal text	30	15
Double width text	31	14
Underline on	15 (DMP-100)	none
Underline off	14 (DMP-100)	none

One other note for those of you with older 4K or 16K CoCos: The old 1.0 version of Color BASIC (if you have 16K RAM and Extended Color BASIC, type EXEC41175 to find out if you have it) uses a 7-bit printer output format, rather than the 8-bit format used by newer machines (including all TDP System 100 and Color Computer 2 units). To use the Gorilla with the Botek CCP-1 interface on such a computer, you will have to either change the jumper wire in the CCP-1 to the 7-bit position (which means that you will not be able to use graphics) or use a driver program for all printing including text. (Radio Shack had this driver available by special order as 700-2013, but they may have discontinued it.) Since you will need to change to a newer ROM if you ever decide to upgrade to 64K, you may want to go ahead and do it now, avoiding all that "patchwork" in the process. (The Color BASIC 1.2 chip runs BASIC programs about 30 percent faster than the 1.0 and 1.1 versions.)

The Gorilla Banana GX-100 printer and Botek's CCP-1 interface give you a real 80-column tractor-feed printer for about \$100 less than Radio Shack's DMP-100. I recommend them to anyone who wants to get a good printer for as little cash as possible.

(Spectrum Projects, 93-15 86th Drive, Woodhaven, NY 11421; printer \$249.95 + \$3 S/H, interface \$49.95 with printer purchase. The interface is also available from Botek Instruments, 4949 Hampshire, Utica, MI 48087, \$69)

**Coco Headquarters**

Coco Headquarters

DELKER ELECTRONICS, INC.  
P.O. BOX 897 DEPT D  
SMYRNA, TN 37167  
800-251-5008  
800-545-2502 (TENNESSEE)  
615-459-2636 (TENNESSEE)  
615-254-0088 (NASHVILLE)

**DELKER**  
ELECTRONICS

R/S CoCo Upgrades	Call
CoCo 2 16k Standard	\$149.95
CoCo 2 16k Extended	\$219.95
CoCo 2 64k Extended	\$299.95
26-3029 CoCo 2 Disk	\$349.95

\* WE STOCK ALL COCO PARTS \*

TOLL FREE  
TENNESSEE  
800-545-2502  
800-251-5008

Coco Headquarters

Coco Headquarters

## WOODHEAT FOR 16K ECB USER FRIENDLY

### STOVE MONITOR SYSTEM

- \* ALARM WARNS IF FLUE TEMP. GOES ABOVE OR BELOW USER SET LIMITS
- \* PLOTS GRAPH \* EASY TO INSTALL
- \* WRITTEN IN BASIC ON CASSETTE

\* \$ 74.95  
INQUIRIES  
\* ORDERS  
ASK FOR 4K

WOOD HEAT  
1032 THIRD AVE.  
W. BELMAR NJ 07719  
(201) 681-7452

**TDP SYSTEM 100\* / QUALITY DISCOUNT PRODUCTS / COLOR COMPUTER\*  
DISCOUNT PRICES / COMPARE / WE'RE FAST**



MARK DATA PRODUCTS	LIST	D/S
Astro Blast	\$24.95	\$22.45
Haywire	\$24.95	\$22.45
Black Sanctum	\$19.95	\$17.95
Calixto Island	\$19.95	\$17.95

TOM MIX SOFTWARE		
KataPillar Attack	\$21.95	\$19.75
The King 32K	\$26.95	\$24.25
The Frog 32K	\$27.95	\$25.15
Trap Fall 32K	\$27.95	\$25.15
Space Shuttle 32K	\$28.95	\$26.05

SOFT SECTOR MARKETING		
Color CaterPiler	\$19.95	\$17.95

SPECTRAL ASSOCIATES		
Meteoroids	\$21.95	\$19.95
Space War	\$21.95	\$19.95
Ghost Gobbler	\$21.95	\$19.95
Robot Attack	\$21.95	\$19.95
Galax Attack	\$21.95	\$19.95
Lancer	TBA	10% off
Whirlybird Run	\$21.95	\$19.95
Ms. Gobbler	\$21.95	\$19.95
Donkey King	\$21.95	\$19.95

KRT SOFTWARE		
F - 16 FLT.		
SIMULATOR*	\$19.95	\$17.95
LPVII/DMP100		
Descenders	\$14.95	\$13.45

\*Please State 16K or 32K

We take 15% off on Prickly-Pear Software

PRICKLY-PEAR SOFTWARE		
Magic	\$19.95	\$16.95
Viking	\$19.95	\$16.95
Gangbuster	\$19.95	\$16.95
Football	\$19.95	\$16.95
I Ching	\$19.95	\$16.95
Numerology	\$19.95	\$16.95
Tarot	\$19.95	\$16.95
Math Pack 1	\$19.95	\$16.95
Fantasy		
Games Pack	\$19.95	\$16.95
Flight	\$19.95	\$16.95
Pre-Read I, II, III	\$24.95	\$21.95
Fantasy Games Pack (32K)	\$24.95	\$21.95
Las Vegas		
Weekend	\$24.95	\$21.95
Phonics 1	\$24.95	\$21.95
Phonics 2	\$24.95	\$21.95
Astrology	\$24.95	\$21.95
Super Astrology	\$24.95	\$21.95
Trilogy (I Ching, Numerology, Tarot)	\$39.95	\$33.95
Colorkit	\$29.95	\$25.95

**PETROCCI FREELANCE ASSOCIATES**

Inspector		
CLUEseau	\$19.95	\$17.95
Stress	\$19.95	\$17.95
Weather Watch	\$19.95	\$17.95
Forecaster & Weather Watch	\$49.95	\$44.95
Stagecoach	\$19.95	\$17.95
Heart - Lung Circu. Sys.	\$34.95	\$31.45
Bowling Secretary	\$24.95	\$22.45
Astrology		
Chart Print	\$21.95	\$19.75
Medical		
Terminology	\$19.95	\$17.95
Patti Pac	TBA	10% off
Hurricane Tracker	TBA	10% off
Pre-School**	\$24.95	\$22.45

\*THIS IS A 32K DISK PROGRAM ONLY

\*\*These Programs are designed for Pre-school children and are all 32K. Price includes all four Programs.

**AARDVARK PRODUCTS**

Haunted House	\$ 9.95	\$ 8.95
Golf	\$ 9.95	\$ 8.95
Space Battler	\$12.95	\$11.65
Killer Bot	\$13.95	\$12.55
Labyrinth	\$14.95	\$13.45
Starship Herc.	\$14.95	\$13.45
Time Trek	\$14.95	\$13.45
Escape from Mars	\$14.95	\$13.45
Pyramid	\$14.95	\$13.45
Qwest	\$14.95	\$13.45
Trek Adventure	\$14.95	\$13.45
Circle World	\$14.95	\$13.45
Nuclear Sub	\$14.95	\$13.45
Derelict	\$14.95	\$13.45
Venture	\$19.95	\$17.95
Tube Frenzy	\$19.95	\$17.95
Caterpillar	\$19.95	\$17.95
Catchem	\$19.95	\$17.95
Tiny Compiler	\$24.95	\$22.45

**EIGEN SYSTEMS**

Basic Aid (cart.)	\$34.95	\$31.45
Stripper	\$ 7.95	\$ 7.15
Ccead	\$ 6.95	\$ 6.25
COLORCOM/E	\$49.95	\$44.95

**SUGAR SOFTWARE**

Silly Syntax	\$19.95	\$17.95
Additional		
S.S. tapes	\$ 9.95	\$ 8.95
Fairy Tales		
Sing Along		
X-Rated		
Current Events		
Adventure		
Potpourri		
Auto Run	\$14.95	\$13.45
TIMS (32K)	\$24.95	\$22.45
TIMS MAIL (32K)	\$19.95	\$17.95
PIRATECTOR*	\$99.95	\$89.95
GALACTIC		
HANGMAN	\$17.95	\$16.15
STATGRAPH	\$24.95	\$22.45

\*Note Requires special order

**DATA SOFT, INC.**

"ZAXXON" By Sega	\$34.95	\$31.95
------------------	---------	---------

**B5 SOFTWARE COMPANY**

Clock	\$24.95	\$22.45
Money	\$19.95	\$17.95
Math Fact	\$16.95	\$15.25
ABC's	\$ 9.95	\$ 8.95
Add - Carry	\$19.95	\$17.95
Subtraction Borrow	\$19.95	\$17.95
Question	\$19.95	\$17.95
Spelling	\$16.95	\$14.95
Hangword	\$14.95	\$13.95

**VIP SOFTWARE**

Alpha Graph	\$14.95	\$13.95
-------------	---------	---------

**CLASSICAL COMPUTING, INC.**

Speak Up!		
Voice Synthesizer	\$29.95	\$26.95

**DSL COMPUTER PRODUCTS**

Copy Cat	\$19.95	\$17.95
----------	---------	---------

**INTRACOLOR COMMUNICATIONS**

Robottack	\$24.95	\$22.45
-----------	---------	---------

**ILLUME DESIGN**

Paint Pot	\$24.95	\$22.45
Diskpro	\$29.95	\$26.95
Tape to Disk	\$14.95	\$13.45
Disk to Tape	\$14.95	\$13.45
Screen Print		
Epson MX-80/100	\$14.95	\$13.45
Elec. Drafting		
Board 64K	\$39.95	\$35.95
Stars	\$19.95	\$17.95
Datafile	\$24.95	\$22.45
Datafile 64K	\$29.95	\$26.95

**COMPUTER CASSETTES**

64K RAMS	\$ .89	\$49.95
* NEW * MARK DATA		
KEYBOARD	REG.	\$69.95
* NEW * Wright Books		
HELP!	D/S	\$ 8.95

**Terms:** Cash, Money Order, or your personal checks welcome. Please allow two weeks to clear your check. Shipping \$2.50 on prepaid orders. Please add \$3 extra for hardware. Arizona residents please add 5% sales tax. All programs - 16K ext. except where noted. We reserve the right to change prices without notice.

**Warranty:** All hardware products are warranted for a period of 180 days from date of purchase. Software is warranted as per its manufacturers warranty. We shall not be liable for loss or damage, alleged or caused indirectly or directly to hardware or software including interruption of service, business loss, loss of expected profits or any damage resulting from the use of hardware or software

**DESERT SOFTWARE**

4321 W. Jupiter • Tucson, Arizona 85741 • (602) 744-1252

## Fowl Play Is Fair Game

I was coming home from my local arcade still excited over my new victories, but, as usual, I was broke. Flipping open my mailbox, inside I found Thunder Vision's new arcade program *Jowst*. I rushed upstairs and nervously loaded it. As I waited for the 16K, 100 percent machine language program to load, I quickly scanned the sheet of instructions. I could feel the arcade action pulsating through my fingers as I slowly typed in *EXEC*. There it was, the flamboyant title screen that I had just left in the arcade, now on my TV screen. The title screen not only displays high score and the modes of play, but it has a sparkling border and *JOWST* written in flashing letters. I selected the one player mode and that is when all the arcade excitement left me. I was in control of a dangerous duck-fighting cantankerous chickens. This just-like-the-arcade program turned out to be a mediocre facsimile.

The documentation is typed on a small sheet of paper with a fancy header. The documentation tells you the object of the game, the three modes of play and gives some general hints. The documentation is vague and it assumes that you have a general knowledge of the arcade game *Joust*. The instructions give enough information to load and play the game, but they leave much to be desired.

The object of the game is to destroy enemy chickens by striking them from above with your duck. One controls his duck entirely through the keyboard and this is one of the program's major faults. The keyboard control is erratic and it distracts from the overall game play. The real problem starts when a two-player mode is selected and two people have to use the keyboard at the same time. Joystick control

would have solved this problem and it would have made game play much smoother.

*Jowst* has three modes of play. They are one-player, two-player and head-to-head. Head-to-head combat is one of the best features of this program. This mode allows two players to *Jowst* it out with no computer-controlled chickens. More games should have a head-to-head option like the one included in this program.

The graphics are probably not what one would see in the arcade, but they are still good. The ducks' and chickens' wings flap as they gracefully move across the screen. After you hit a chicken from above, it turns into an egg that slowly sinks to a platform. The eggs change colors just before they hatch so you know just about how much time you have before the egg hatches into another chicken. Even though the graphics are good, I still lost interest in the program after playing it a few times.

The sound, on the other hand, is definitely not what one would hear in the arcade. It's nothing more than a few beeps and buzzes. There is no difference in sound when you get killed or when you kill a chicken, so it is sometimes hard to figure out what happened. The author blames the poor sound on a concentrated effort to make this game work on 16K computers so that it would not be necessary to purchase any expensive upgrade kits. I find this very strange since you could upgrade to 32K for less than the price of *Jowst*.

This game is fair, but it obviously does not "play just like the arcade." In my opinion, if you have 16K this program might be worth looking into, but if you have 32K I suggest that you select one of the 32K *Joust*-like programs.

(Thunder Vision, P.O. Box 3241, Grand Junction, CO 81502, 16K cassette, \$28.95)

—Steven Schweitzer

Second Annual

# Rainbow Adventure Contest



So, you're an old hand at playing Adventures, are you? And you're confident that you could write an Adventure that would change the entire course of Adventure writing. Or, maybe you already have a winner that you're wanting to share with the world — and win yourself a disk drive 0 in the process! Here's the chance to shine: The Second Annual Rainbow Adventure Contest.

Your Adventure can have any setting you want; it can be 4K to 64K, Extended BASIC or Color BASIC, machine language, too. A FLEX or OS-9 Adventure? Why not? You've written a graphics Adventure? Great! This is a wide open contest and the format can be as varied as your imagination. At this point, there are no specific categories. We do promise that if you write a 4K Adventure that it will get the special consideration due this limited format, but it's really a no-holds-barred, give-us-your-best-shot contest — and if you're the only *BASIC09* graphics entry, why, how could we help but give you a prize? Originality counts plenty.

Be sure to tell about your Adventure, including how to win it; it may have us stumped. Point out the salient features of your creation and comment on any aspects that deserve the judges' attention. Put any accompanying article, cover letter or documentation *on paper* and put *the program itself on tape or disk*. This is a must; we will not type in even the shortest of entries. Lastly, put your name on everything and be sure and write-protect your disk or punch out the tabs on your cassette so nothing gets accidentally erased.

Above all, get it in by May 1, 1984, in bug-free condition complete with any necessary instructions. Keep following *the Rainbow* for more details and a complete list of prizes, but remember there'll be something for everybody — for example, every entrant will receive a free pass to the RAINBOWfest of his or her choice!

**RULES:** All programs must be original works, no "conversions." Entries must be postmarked by May 1, 1984, and become the property of Falsoft, Inc., publisher of *the Rainbow*. Decision of the judges is final. Duplicate prizes will be awarded in the case of ties. Winning programs to be featured in a special *Rainbow* Adventure issue. Mark entries "Adventure Contest Editor" and send to *the Rainbow*, P.O. Box 209, Prospect, KY 40059.

# B5 Software

B5 believes the Computer is a unique teaching tool and deserves quality software. Our programs are based on sound learning principles and make learning fun.

Rated 4-Star  
by Radio Shack

## EDUCATIONAL PROGRAMS

for your **TRS-80 COLOR COMPUTER\* & TDP-100\***  
with Extended Basic

### CLOCK †



Grades 1-4. Helps children practice telling time. 4 skill levels: hour, quarter hour, 5 minute and 1 minute intervals. Options include reading hours and minutes separately on the large graphic clock with synchronized hands. After 10 correct answers a small mouse ascends to the tune of Hickory, Dickory, Dock.  
16K Cass \$24.95 32K Disk \$26.95

### MONEY †

Grade 2-4. Provides an opportunity to count coins. 5 skill levels range from counting only dimes, nickels and pennies to counting various combinations of all coins which can total more than one dollar. The program uses graphic coins. If a series of 3 problems are answered correctly a rocket ascends to the moon. If 1 or more are incorrect, the rocket crashes instead.  
16K Cass \$19.95 16K Disk \$21.95

### BORROW †

Grades 2-4. Allows the student to reinforce subtraction skills. Problems appear in large graphic numerals. Small boxes above the numerals allow for regrouping procedures. 7 skill levels. A happy face appears on the screen for each correct answer. After 10 completed problems, a Pac-Man-type creature munches a numeral down.  
16K Cass \$19.95 32K Disk \$21.95

### CARRY †

Grades 2-4. A program designed to help students to practice addition. Uses same format as Borrow. 4 skill levels.  
16K Cass \$19.95 32K Disk \$21.95

### QUESTION

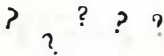

Grades 1-8. Asks questions with multiple choice or true and false answers. Fits any curriculum because you can input the questions and answers. Graphic reward is a blinking robot. Also designed for use with data tapes. Printer use optional.  
16K Cass \$19.95 32K Disk \$21.95

### MATHFACT †

Grade 1-5. Motivates students to learn their facts. All 4 math operations are in the program. Student selects the desired operation then the desired addend, subtrahend, factor or divisor, or then can request a mixed presentation within each operation. 2 skill levels, all drills timed and scored. If all facts are answered correctly, students can play a quick number game as a reward.  
16K Cass \$16.95 32K Disk \$18.95

### HANGWORD & SCRAMBLE

Grades 1-8. Presents 2 word games. Hangword is similar to the old favorite, Hangman. Blanks appear and students guess letters for the blanks. Wrong guesses build the graphic display of the word 'Sorry'. Scramble displays the word with the letters scrambled. Students guess the word and spell it correctly. Input own words with this program or purchase data tapes. See data tape listing. Printer use optional.  
16K Cass \$14.95 32K Disk \$16.95

### SPELLING

Grades 1-8. Very flexible as it allows you to input your own choice of words and store them on tape files. You may also purchase data tapes for this program. See data tape listing. Words flash on the screen from .1 to 10 seconds, then student types the word. The score is given after each entry and the student is rewarded with a graphic display of words and a song. Printer use optional.  
16K Cass \$16.95 32K Disk \$18.95

### KEYBOARD

Grades 1-6. Helps familiarize student with keyboard. A graphic keyboard enables user to locate keys quickly. Home keys are identified and proper fingering may be taught. Lessons are built around alphabet, finger, word and sentence drills. At the end a graphic reward is given. 32K version has lengthier timed drills. Both 16K and 32K versions can use data tapes for further practice. See data tape listings.  
16K Cass \$19.95 32K Cass \$24.95 32K Disk \$26.95

### ABC'S

Grades K-1. The child types the letters in the alphabet to the tune of the alphabet song. The reward is a graphic and sound display.  
16K Cass \$9.95 16K Disk \$11.95

### SKIP COUNTING

Grades 1-4. Helps the child learn to count by 1's, 2's, 5's, 10's, 100's, or any number desired. The user selects the parameters by giving the number to count by and the beginning and ending number of each sequence. The student can practice at whatever level needed, and each lesson has a graphic reward.  
16K Cass \$16.95

## DATA TAPE LISTINGS

Data Tapes may be used with other B5 programs. They cannot be used alone.

Use with Keyboard Program

**KEYBOARD PHONIC DRILL** - Letter, word and sentence finger drills using common vowel and consonant combinations. \$8.95

Use with Keyboard, Spelling or Hangword Programs  
**DOLCH WORDS** - 273 words used most often in beginning readers. \$8.95

Use with Keyboard, Spelling or Hangword Programs  
**GRADE LEVEL SPELLING** - Over 300 words on each tape. Each lesson follows a phonic rule. Available in Grades 2,3,4,5 or 6 levels. \$8.95 per grade level

**SPACE WORDS** - Over 300 words to challenge and motivate the superior speller. Grades 4-8. \$8.95

**ADULT WORDS** - Most often misspelled words. Highly challenging. \$8.95

Use with Questions Program

**NOUNS AND VERBS** - 4 lessons on nouns and 4 on verbs. Grades 3-5. \$8.95

**READING COMPREHENSION** - Lessons build from simple to complex. Grades 2-4.

Main Idea	\$10.95
Sequencing	\$10.95
Fact & Opinion	\$10.95
Cause & Effect	\$10.95
Complete Series of 4	\$39.95



Ask your Dealer for a Demonstration today!

**BROCHURES UPON REQUEST**

\*TRS-80 and COLOR COMPUTER are Trademarks of Tandy Corp.

If unavailable locally, send check or money order to:

**B5 Software**  
1024 BAINBRIDGE PLACE  
COLUMBUS, OHIO 43228

(614) 276-2752

Free Shipping in U.S.A. & Canada

TOTAL ENCLOSED \_\_\_\_\_

NAME \_\_\_\_\_

ADDRESS \_\_\_\_\_

CITY \_\_\_\_\_ STATE \_\_\_\_\_ ZIP \_\_\_\_\_

OH Residents add 5% Sales Tax

QTY	AMT
_____	CLOCK _____
_____	MATHFACT _____
_____	QUESTIONS _____
_____	MONEY _____
_____	SKIP COUNTING _____
_____	HANGWORD _____
_____	SCRAMBLE _____
_____	CARRY _____
_____	KEYBOARD _____
_____	BORROW _____
_____	ABC'S _____
_____	SPELLING _____

QTY	DATA TAPES	AMT
_____	KEYBOARD PHONIC DRILL	_____
_____	DOLCH WORDS	_____
_____	GRADE LEVEL SPELLING	_____
_____	GRADE 2 • GRADE 3 • GRADE 4	_____
_____	GRADE 5 • GRADE 6	_____
_____	SPACE WORDS	_____
_____	ADULT WORDS	_____
_____	NOUNS AND VERBS	_____
_____	READING COMPREHENSION	_____
_____	SUBTOTAL	_____
_____	SALES TAX	_____
_____	TOTAL ORDER	_____

## What Will Your Social Security Benefits Be?

Parsons Software's *FICA-83* programs will really tell you, clearly and accurately, how much you will get when you reach that magic age, and give it to you in hard copy if you want to.

I had been out of town on a long weekend, arriving back home about 6 p.m. When I went through my mail I found a *FICA-83* for review. I usually put the cassette into the recorder, put the program into the computer and attempt to run the program "by the seat of my pants," but, being tired from driving, I decided to read the instructions and then look at the program the next day.

In only minutes of reading the instructions, I realized that this was not the work of an amateur, but of a professional. In my experience, fully 50 percent of all software instructions are poorly done by people who have never had the advantage of the English teacher who insisted upon "unity, coherence and emphasis." Parsons Software instructions for the use of the *FICA-83* programs, however, would receive high marks from my English composition teachers. They are clear, concise and complete. They also tell you that the programs are disk compatible, and they are. After reading the instructions I could not wait to try the programs.

After putting the programs into my CoCo and telling CoCo to *RUN*, I realized that, as good as the instructions were, they were really not necessary. The programs are

straightforward and fully self-explanatory; asking all the right questions and responding immediately to the answers.

There are two programs on the cassette, one (*FICA-83s*) for a quick determination of your Social Security cash entitlements and printing the results to the screen, and the other program (*FICA-93P*) prints out a complete summary of your Social Security benefits using the personal data which you have entered by answering the clear questions asked by the program. These programs need no long study or trial and error, but will give you what you are looking for, and in a hurry! Both programs have incorporated the latest changes in Social Security law and provisions for those who continue working after retirement age.

All you have to do is, in answer to questions on the screen, tell the computer when you were born, when you started to work under FICA and when you plan to retire, whether or not your salary was less than the minimum annual earnings needed to pay the maximum FICA tax for each year and your estimate of COLA increases in the future. I estimated 3 percent. If you are married, you enter the birthdate of your spouse. If you want a hard copy report, just answer that question by entering "Y" and you get a professional looking report.

In summary, these programs do just what the instructions say they will do and with a minimum of effort on the part of the operator. They are truly "user friendly." Congratulations to Parsons Software!

(Parsons Software, 118 Woodshire Dr., Parkersburg, WV 26101, tape \$19.95)

—Charles L. Redman, Jr.

## Marymae INDUSTRIES, INC.

In Texas, Orders,  
Questions & Answers  
1-713-392-0747

22511 Katy Freeway  
Katy (Houston), Texas 77450

To Order  
1-800-231-3680  
800-231-3681

### SAVE BIG DOLLARS ON ALL TRS-80® HARDWARE & SOFTWARE

TRS-80® by Radio Shack. Brand new in cartons delivered. Save state sales tax. Texas residents, add only 5% sales tax. Open Mon. - Fri., 9 - 6, Sat., 9 - 1. We pay freight and insurance. Come by and see us. Call us for a reference in or near your city. Ref: Farmers State Bank, Brookshire, Texas.

### WE OFFER ON REQUEST

Federal Express (overnight delivery)

Houston Intercontinental Airport  
Delivery, Same Day Service

U.P.S. BLUE—Every Day

References from people who have  
bought computers from us probably  
in your city. We have thousands  
of satisfied customers. WE WILL  
NOT BE UNDERSOLD!

ED McMANUS



No Tax on Out of Texas Shipments!

Save  
10% 15%  
OR MORE

### WE ALWAYS OFFER

- We accept MasterCard, Visa and American Express cards
- We use Direct Freight lines. No long waits
- We always pay the freight and insurance
- Toll free order number
- Our capability to go to the giant TRS-80® Computer warehouse 5 hours away, in Ft. Worth, Texas, to keep *you* in stock.

® TRS-80 is a Registered Trademark of Tandy Corp.

JOE McMANUS

TELEX: 77-4132 (FLEXS HOU)

# PETROCCI FREELANCE ASSOCIATES

## HOMEOWNER SELLING ANALYSIS READY TO SELL?

This program provides an accurate return on investment analysis and shows benefits of selling now or waiting for a certain period of time.

How will a major improvement affect value of your home? This program can tell you.

Analyze sales made with and without realtors commission.

Change input variables to reach percent return on investment which you desire?

Will even calculate your unpaid mortgage balance for you.

An invaluable tool. Printer Output Option. Easy to use — well documented.

16k EXT TAPE \$24.95    32k EXT DISK \$29.95

## OWNER FINANCED REAL ESTATE

### For Both Buyers & Sellers

Program helps you evaluate offers and prepare counter offers. Comes with handy worksheet for quick side-by-side comparisons.

The complex analysis of converting future cash payments of an owner financed sale to the equivalent of a pure cash sale is performed by this program in seconds. And what's even better, the complexities of an owner financed sale are well explained and all terminology defined. Program calculates monthly mortgage payment due to seller, Balloon Payment Amount and equivalent cash sale amount. Well documented — Printer Output Option.

16k EXT TAPE \$24.95    32k EXT DISK \$29.95

**BOWLING SECRETARY**  
Allows Mid Season Entry  
\$24.95

**ASTROLOGY CHART PRINT**  
Epson MX80 LPVII (specify)  
32K T \$21.95

**RESULTANT WAVE PLOTTER**  
\$15.95

**PRESCHOOL PACKAGE**  
ABC-123-Shapes-Biggest  
\$24.95

**INSPECTOR CLUESEAU**  
32K T \$19.95

**PATTI-PAK (The Best!)**  
\$21.95

**TYCOON (Coco Monopoly)**  
32K \$19.95

**FLASHER (Memory Game)**  
Ages 6 to Adult  
\$19.95

**REAL ESTATE  
INVESTMENT**  
\$24.95

**BOND ANALYSIS**  
\$19.95

**INVOICE PROGRAM**  
\$19.95

**STATISTICAL ANALYSIS**  
5 Stat Functions Plus  
Analysis of Variance  
32K T \$34.95

All Programs 16K Tape  
Unless Otherwise Specified  
All Programs Available on Disk  
Disk Versions Add \$5.00

**HEART-LUNGS-  
CIRCULATORY SYSTEMS**  
32K (T) \$34.95

**MEDICAL TERMINOLOGY**  
32K (T) \$19.95

**STRESS EVALUATOR**  
\$24.95

**WEATHER WATCH**  
\$24.95

**WEATHER FORECASTER**  
32K Disk Only \$19.95

**HURRICANE TRACKER**  
16K (T) \$15.95    16K (D) \$20.95

**DUNK-A-DUCK**  
\$19.95

**SUPER DISK UTILITY**  
\$44.95

**MASTER GRAPHICS TOOL KIT**  
32K Disk Only \$44.95

Include \$1.50 for handling for each program.  
Arizona residents add 7% Sales Tax.  
Quantity Discounts to Dealers.



# INTERNATIONAL COLOR COMPUTER CLUB, INC.

Main Office  
2101 E. Main St.; Henderson, TX 75652

Canadian Branch  
P.O. Box 7498, Saskatoon, SK S7K-4L4

Book & Program's Library  
119 County Fair, Houston, TX 77060

Parts Library  
P.O. Box 1220, Henderson, TX 75653

Voice Line (214) 657-7834 \*

BBS Line (214) 657-8147

World's Largest Color Computer Club



## COLOR COMPUTER™

Congratulations on your success  
in putting together such a fine  
group as the "ICCC, Inc."...

Dallas R. Cox

**QUESTIONS**  
**REVIEWS**  
**LETTERS**  
**NEWS**

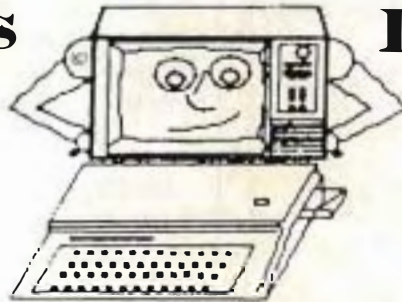

**DISCOUNTS**  
**PROGRAMS**  
**ARTICLES**  
**ANSWERS**

## TRS-80<sup>®</sup> • MC-10<sup>™</sup>

To Become a member: Write to the club for an application or send in your complete name, address, and phone # with the correct amount of dues listed below:

USA MEMBERS \$30.00 CANADA & MEXICO MEMBERS \$40.00 OUTSIDE  
THE USA \$50.00 (surface) \$90.00 (Air Mail) ALL PRICES ARE IN  
U.S. Dollars. Non-U.S. funds will be rejected. Prices for year.

Discounts offered are from 5% to 25% from Major companies such as  
DSL Computer Products, RAINBOW, PCLEAR-80, and much, much more...

Our Library contains over 150 programs for CoCo, TDP-100, and MC-  
10 along with 20 (or more) R.S. ROMpacks and over 100 good books.

Our Parts Library can save you down time while waiting for a part  
for your computer and the price for parts is not that high if you  
decide to buy the part instead (eg. CoCo case \$28.13 or 64K chips  
for \$46). We also do upgrades to your computer for a small \$15.00  
fee.

For more information or charge application over the phone you can  
call either the VOICE line (regular telephone line) at (214) 657-  
7834 or call the Bulletin Board System at (214) 657-8147.

™ Color Computer and MC-10 are Trademarks of the Tandy Corporation

® TRS-80 is a ® Trademark of the Tandy Corporation



# Problems?

## No, Just Pre-Solved Situations

By D. S. Lewandowski

This month we will discuss a topic no one seems to want to talk about. That topic is "problems." How they are made, and avoided. First, I would like you to take the correct approach in problem solving. Keep a pad of paper, or better yet, a notebook, handy. This way, if you encounter a problem, you can write down a specific question, and leave enough space for an answer. This way, you will only have to solve that problem once. There are a couple of different methods to solve each problem. One of the best is a Computer Club. See if someone else in the group has already encountered your problem—why reinvent the wheel? The second is asking the manufacturer. This method requires "careful" documentation. Don't expect an instant answer, most of the time the manufacturer must check with many people to see who has encountered it, and why! To solve a problem without documentation is completely impossible. Don't rely on your memory, you'll end up using phrases such as "I think . . .," "I'm pretty sure . . .," and so on. Use your pad or notebook, to your best advantage.

Let's get some terms straight before we continue. The term "source code" refers to the text we type into the editor. It is saved to tape using the "W" command. (Example: W TEST would save a source code file to tape using the name TEST.) The source code can only be loaded into the editor, and allows you to edit the file easily, and you can save a lot of retyping if saved prior to testing the program. Then we have "object code," which refers to the actual machine language program. It can be loaded into the computer with the *EDTASM+* cartridge. And depending on the program, it can operate independently. (Example: A test would save an object code file to tape using the name test.) Finally, we have a "ML LISTING"; this is a listing of the actual byte code of the program, and is usually in hexadecimal. This listing could be put in with a monitor program such as *ZBUG*.

The reason I mention these terms is due to the first question many people ask. "What do I type in?" Most assembly listings you find in the magazines are either source code, or a combination of source code and ML listings. In all cases, just remember that the source code starts with the label field. In inputting text into the editor, always start with the label.

The following problems, and solutions, are based on the *EDTASM+* cartridge sold by Radio Shack. These seem to be the most often encountered, and frustrating, problems for beginners and old hands alike. The most misunderstood command in assembly language is *ORG*, which is short for *ORIGINATE*. This should be the first command in the text. It tells the editor/assembler where the program is to begin in the computer's memory. If you assemble the program using *ZBUG* with the *AO* (Absolute Origin), and the program conflicts with any of the memory *ZBUG* is using you will get "BAD MEMORY" errors. There are two ways around this, first don't use the *AO* option. Second, assemble the program to tape, and reload it without the *EDTASM+* cartridge. Always save your source code prior to powering down your computer!

The error "bad label" can be generated many different ways. The most popular is entering text in which the author uses a label like "A@." Although the @, or ampersand symbol, is not a reserved character in *EDTASM+*, it just doesn't like it. So don't use it. Instead, substitute another A. (Example: A@ use AA if you encounter another A@ later in the listing, which is legal in *MICRO-WORKS SDS80C*, use another letter like AB.) The other common mistake, which will drive you crazy, is pressing the space bar prior to pressing the right arrow. For some reason *EDTASM+* sometimes ignores the space; other times it will use it as part of the label. For this one it's easiest to just retype the line.

The "multiply defined symbol" error can be generated with the same ease as bad label. Once you have figured out that *EDTASM+* doesn't like the ampersand symbol you substitute another letter and get this error. Use the symbol table generated by the assembler to keep track of the symbols used. You can use the options of *EDTASM+* to generate just a symbol table. (Example: A/ NL/ LP would send an error count and symbol table to the printer.) Also, the first five characters being the same can generate this error, sometimes! (Is this a bug?)

If you have ever attempted to use the global editing features of *EDTASM+* and were rewarded with a series of *SEARCH FAILS* for your efforts, don't lose faith. Using the commands you must remember that a space is a valid character. (Example: F LOOP1 would look for the word LOOP1 preceded by a space, using FLOOP1 to find the word.) Also, when using the renumbering option N, always move the text pointer to the beginning of text. Otherwise, renumbering will start at the current line of text. (Now how

---

*(Dennis Lewandowski, one of the early authors active with the Color Computer, specializes in machine language programming. He and his wife, Rose, founded DSL Computer Products.)*

# TRS-80 COMPUTERS

ALL PURE RADIO SHACK EQUIPMENT

**DISCOUNT**  
**15%**  
**AND UP**  
**OFF SUGGESTED LIST**

## COMPUTERS

ALL TRS-80  
MODELS

**CALL FOR  
COMPETITIVE  
PRICES**



## PRINTERS

- RADIO SHACK
- EPSON
- OKIDATA
- C. ITON
- SMITH CORONA

**CALL FOR  
COMPETITIVE  
PRICES**



## ACCESSORIES

WE CARRY A FULL LINE OF:

- SOFTWARE
- HARD DRIVES
- MODEMS
- PRINTER ACCESSORIES
- TELEPHONES AND ANSWERING MACHINES

## GAMES

- BIG FIVE
- ADVENTURE
- SPECTRAL
- INSTANT SOFTWARE
- TOM MIX SOFTWARE

**FREE** PLEASE WRITE AND REQUEST . . .  
• CUSTOMER DISCOUNT PRICE LIST  
• MANUFACTURE WARRANTIES

TRS-80 TANDY CORPORATION

## PERRY COMPUTERS

Dept. No. C-3 137 NORTH MAIN ST., PERRY, MI 48872

**FOR ORDERS CALL 1-800-248-3823**

FOR INFORMATION CALL (517) 625-4161

did two line number 100s get in there?) Use the P# command first!

Okay, you've completed the program, you have saved the source code, the object code, and have a hard copy listing. Still, when you *CLOADM* and *EXEC* you get pretty graphic patterns, and you typed in a utility program! Hmmm, something is wrong! The most frequent cause is the *EXEC-ute* location. The last line of the program should *always* be something like *END START*. Of course, some authors use words like *ENTRY*, *BEGIN*, *MAIN*, etc. These words all refer to where the program should begin running. If the author omits which label he is using for *START*, assume the first label of the program should be the starting address. The last line of text should always be something like *END*

*START*. Otherwise, the assumed execution address is zero!

Finally, the error message that strikes fear into every assembly language programmer. "Bad opcode" — it's in the magazine, but look high and low, you can't find it anywhere else. You can't even figure out what it's supposed to do! As usual, there is a way around it. Hopefully there is a ML listing. Use the *FCB* to manually insert the byte codes. (Example: *1F 89 4D TAB* (ML listing and opcode as in article.) Substitute the following *three* lines: *FCB \$1F FCB \$89 FCB \$4D* (Remember only *one* number per *FCB* line).)

That's enough for this month. I would like to remind you that if you are having troubles with a program, starting this month, Dan Downard has a question and answer column. Please remember that incomplete questions are impossible to answer, so send questions with documentation and examples.

## Back Issue Availability

Back copies of many issues of *the RAINBOW* are still available.

All back issues sell for the single issue cover price — which is \$2 for copies of Volume I, Numbers 1-8 (through February, 1982), \$2.50 for Volume I, Numbers 9, 10 and 12 (through June except May, 1982) and \$2.95 for Volume II, Numbers 9, 10, 11, 12 (March, April, June and July 1983). Also \$3.95 for Volume III, Numbers 3-7 (October 1983 through February 1984). In addition, there is a \$3.50 charge *per order* for postage and handling if sent by United Parcel Service and \$6 for orders sent U.S. Mail. UPS *will not* deliver to a post office box or to another country. This charge applies whether you want one back issue or all of them.

Most back issues are available on white paper in a reprint form. Issues out of print include May, July, August, September, October, November, and December, 1982 and January, February, April, 1983. VISA, Master Card and American Express accepted. Kentucky residents please add 5 percent state sales tax.

Due to heavy demand, we suggest you order back issues you want now while supplies last.

In addition, copies of the cover *only* of the July, 1982, Anniversary Issue are available separately for \$1 each, plus 50 cents shipping and handling. These are suitable for framing.

The Color Computer **GRAPHICS EDITOR**

**DRAW ALMOST ANYTHING**

- ◇ DUPLICATE ◇
- ◇ DUMP to R.S. 4 COLOR PRINTER ◇
- ◇ PMODES 1,3, and 4. 2 colors or 4 ◇
- ◇ Swap Colors % Magnify % Shrink ◇
- ◇ Fine Joystick Cursor control ◇
- ◇ FULL PAGE Dot-Matrix Print Out ◇
- ◇ Save it. ◇
- ◇ FILL ◇
- ◇ Letters ◇
- ◇ Rotate ◇
- ◇ Grid ◇



**ACTUAL SCREEN PRINT!**

**WHAT CAN YOU DRAW?**



T.V. GRAPHICS EDITOR

TIRED OF PLAYING GAMES? The TV Graphics Editor allows you to expand your creativity. Simple joystick cursor control and powerful but easy to use keyboard commands allow you to create, print, save, and use anything the screen will display. Become an artist, make blueprints, design graphics, plan the terrain for Your next video game. TVG Editor makes it easy with great features:

- \*\*\*4 or 2 color CGP-115 printer SCREEN PRINT.
- \*\*\*Full page Radio Shack DMP SCREEN PRINTS. (DMP100,200,400, LPVII,VIII)
- \*\*\*HI-RES: PMODE's one, three, and four.
- \*\*\*Draw dots, lines, arcs, ellipses & circles, letters. Magnify, duplicate, paint with amazing colors, exchange colors, etc., etc.
- \*\*\*Easy corrections, if you draw something you don't like.
- \*\*\*CSAVEM picture to cassette for later use with BASIC or ML programs, or for later editing.
- \*\*\*TVG EDITOR is only \$29.95 Cndn. or \$24.75 U.S.

INTERNATIONAL SOFTWARE INC

ORDERING INFORMATION

All three programs are 100% machine language and will run with any version of BASIC, on any TRS-80 Color Computer, including COCO 2 and 64K COCO.

Quantity Discounts for your store, COCO club, or users group. Mix any of the three fine programs. 5-9,30%; 10-19,35%; 20-29,40%. More, please call.

Please send cheque, money order, or VISA number with expiry date and signature to:

INTERNATIONAL SOFTWARE, INC.  
820 DUNSMUIR ROAD,  
VICTORIA, B.C., CANADA, V9A 5B7



Or, Phone (604) 384-2626

Please include \$3 for handling and shipping. B.C. residents add sales tax. American customers may use U.S. funds for convenience, others please use Canadian funds. Please allow two weeks for personal cheques to clear.

```
LIST      +++SCREEN TWO+++
10 CIRCLE(126,96),56,1
20 PRINT@12,"+++SCREEN TWO+++";
30 PRINT@430,"Black or White";:PRINT@464,"
Background";
40 POKE32753,4:POKE32754,54:PRINT@480,"Sel
ect 32 to 85 letters per line, 1 to 27 lin
es on screen. :POKE32753,5:POKE32754,51
50 PRINT"Works normally with most BASIC pr
ograms; Regular, Extended, or Disk."
60 POKE32753,6:POKE32754,42:PRINT"REAL low
er case. Graphics as you watch."
OK
RUN
```

Black or White  
Background

Select 32 to 85 letters per line, 1 to 27 lines on screen.  
Works normally with most BASIC programs; Regular, Extended, or Disk.  
REAL lower case. Graphics as you watch.  
OK

SCREEN TWO

EXPAND YOUR DISPLAY!



Does all your printing on the Hi-Res PMODE 4 Graphics screen, in a manner compatible with COLOR, EXTENDED and DISK BASIC, for 16K or 32K. It's a vast improvement over the original screen in virtually all respects.

- \*Line lengths from 1 to 85.
- \*True lower case with decenders.
- \*Position independent code.
- \*PMODE 4 Graphics on screen with text.
- \*Lines on screen from 1 to 27.
- \*Inverse video.
- \*Instructions for saving to disk.
- \*Make text "window"

\*With its condensed character sets, SCREEN TWO uses only 1-1/2K of your valuable system RAM.

\*Just \$14.95 Canadian or \$12.50 U.S.

SCORE 011585    SHIPS 4    FUEL 297    HIGH 000000

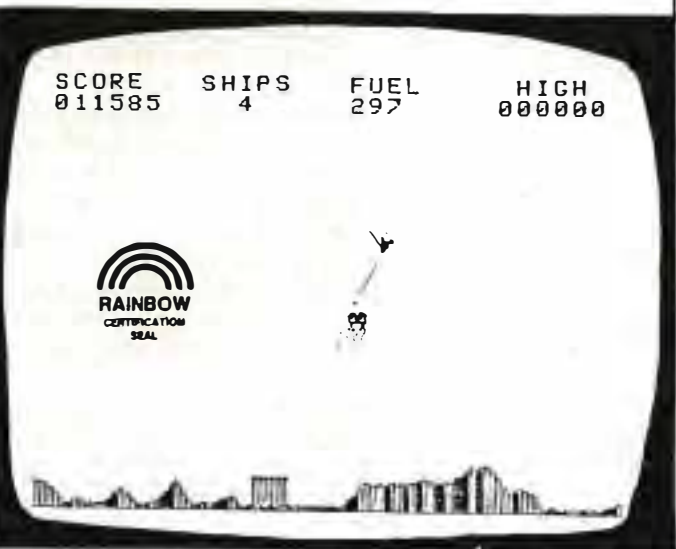

PLANET CONQUEST

Combines the SKILL of learning to pilot and land your spaceship as in a "LUNAR LANDER" with the THRILL of aerial dogfights with flying monsters that threaten the success of your mission.

Dangerous landings and variable gravity add to the excitement. There are 3 "Lander" levels plus 6 more with monsters. \$19.95 Canadian or \$16.50 U.S.

## When A Graphic Idea Strikes . . .

By Joseph Kolar  
Rainbow Contributing Editor

**S**uddenly, you have an idea! You wonder if it is possible to make an alphabet out of the graphic characters available to your CoCo [CHR\$(128) to CHR\$(255)]. You can't recall seeing it done, and more importantly, wonder if you could do it. There is only one sure way to find out. Try it!

Before you dash off to the keyboard, mulling the idea over in your mind, visualize the problems you might encounter. Determine your abilities and reference library sources to see if they are well enough advanced to cope with the problems you anticipate. If you feel you are not ready to attack the problem at this point in time, it does not follow that in a few month's time you will not have acquired the necessary know-how to tackle the problem.

Make a note of the idea. Describe it as best and fully as you envision it. File it away for a future project. Ideas are so fragile and fleeting that it is imperative that they be written down or they may be lost forever.

Back to the drawing board! First, figure out the smallest boundary required to enclose all of the letters. Anticipate which letters might give you a problem. Get a piece of paper and rule a bunch of lines to make a grid. If you figured out that you needed a 6 x 6 grid to house the letters, make boundary lines around 6 x 6 units. Note that you are really using a 3 x 3 matrix in the PRINT@ Screen Locations. Each of the graphic characters are divided into four units (two wide and two down). CHR\$(128) has four units which are all black.

Start by sketching in letters "A," "B," etc. If it looks feasible, sketch in the difficult ones like "K," "Q," "Y." Are the likenesses readily identifiable?

Use pencil to block them in. Erase and adjust is the name of the game. After you determine that most of the characters are adequate, you may try a little "hands-on."

Create a training aid at this point. (See Figure 1.) Fold a sheet of typing paper in half. Make two rows of eight squares. Divide each into four equal segments. Label them left to right as follows: 128; 143; 129; 130; 136; 132; 134; 137.

---

*(Joseph Kolar is a free-lance writer and programmer dedicated to proselytizing for computers in general, and the CoCo specifically.)*

Drop to the second row. Again, from left to right, number them: 135; 139; 142; 141; 133; 131; 138; 140. Color in the appropriate segments of CHR\$(128) to CHR\$(142).

Notice the pattern. Top row: All on; all off. Next four: three of the four units are colored black, in a clockwise direction. Last two: diagonal down; diagonal up. Bottom row: four left blocks have one segment colored black and the last four have two adjacent segments colored black.

At the left edge of your training aid, in a column entitled "PRINT@," list vertically 0; 32; 64; 96; 128; 160; 192; 224. These are the rows above the horizontal centerline of the screen. A few spaces to the right of 0, continue in a second column: 256; 288; 320; 253; 384; 416; 448; 480.

On the right side, print under a column labeled, "COLOR": 143+16 yellow. Then, under the "+," continue with +32 blue; +48 red; +64 buff; +80 cyan; +96 magenta and +112 orange. If the colors on your monitor or TV screen are other than what you have listed, you can make appropriate notes.

Place the completed chart between the air vents of the CoCo. You will be able to refer in a logical sequence to the chart when looking for a shape. Under the shape will be CHR\$ number. You will find this chart useful so don't throw it away.

How would you create a letter using the graphics, CHR\$(128) through CHR\$(143)? Sketch in the shape of the letter. Consult your training aid to see which combinations you have to work with. Break up the 6 x 6 grid, so that you have four unit squares like the CHR\$ graphic element.

Look up and see which CHR\$ character is exactly the same as the contents of your 2 x 2 blocks.

A square-topped "a" will fit a 3 x 3 box nicely. The first row could be labeled [A\$]; the second [B\$] and the bottom row, [C\$].

Putting them into program lines you would have:

```
10 A$=CHR$(129)+CHR$(131)+CHR$(130)
20 B$=CHR$(132)+CHR$(140)+CHR$(136)
30 C$=CHR$(133)+CHR$(143)+CHR$(138)
```

AA\$ designated the completed letter by combining the elements of the three rows.

```
500 AA$=A$+B$+C$'square top
800 PRINT@32+2,AA$
```

## STANDS

TS-1 Monitor stand for 13" TV.  
\$29.50 15W x 11D x 4H with cut-out for ROM pack and ventilation holes.

PS-1 To elevate TV where computer does not slide underneath.  
\$19.95 5W x 11D x 2½H with no cut-out. Can also be used as a Epson printer stand. (not pictured)

TS-5 TV stand for disk drive and color computer enclosure.  
\$39.50 24W x 11D x 5H with cut-out for ROM pack.

TS-4 TV stand for 19" TV.  
\$39.50 24W x 11D x 4H with cut-out for ROM pack and ventilation holes.

MH-1 Magazine holder with semi tubular riveted clip for large magazines. Reverse side has lip for single sheet.  
\$25.00 9 x 12 face.

PS-3 Printer stand for DMP-200.  
\$28.75 16W x 15D x 2½H (not pictured)

PS-4 Same as above except with 1" wide slot in middle for bottom feed printers.  
\$32.25

**All stands available in smoked gray, ivory, or clear.**

### WARRANTY

All stands warranted for 1 year  
Amdek Monitors for 2 years  
Disk for 90 days  
Zenith 131 for 90 days  
123 for 1 year  
J&M 90 days

### GUARANTEE

Any product may be returned within 30 days for refund if not satisfied.



**Howard Medical Company**

Box 2, Chicago, Illinois 60690  
(312) 944-2444



## MONITORS



TS-1 & 300A



TS-5, C-1 & DD-3



TS-4

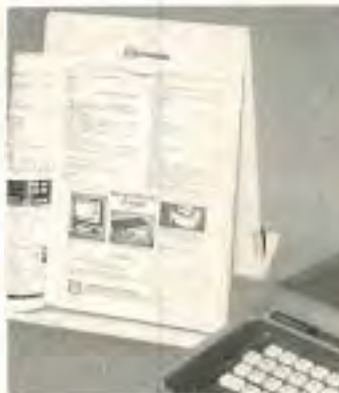

MH-1

300A 12" amber screen. High resolution 18MHz bandwidth. Extra speaker needed for sound. (Amdek)  
\$177

123 12" green screen. High resolution 15MHz bandwidth. Extra speaker needed for sound. (Zenith not pictured)  
~~\$123~~  
\$98.50

C-1 13" screen, color display. Medium resolution 4MHz bandwidth. Speaker included. (Amdek)  
\$354

131 13" screen, color display. Medium resolution 2.5MHz bandwidth. Green screen switch, speaker included. (Zenith not pictured)  
~~\$379~~  
\$339

**All monitors need video interface below.**

## DISKS

DD-3 Dual 3" disk drives. 40 track double density 368K bytes on-line. Can be used as stand alone system or with other drives. Built-in fan. Can record on both sides of diskette. Drive light changes color to indicate side. Amdek.  
~~\$499~~  
\$449

## CONTROLLERS

VC-1 Video interface mounts inside color computer by lifting IC and piggy backing it on top of interface. No soldering and no traces to cut. Gives video on one cable/sound on second cable.  
\$24.45

DC-1 ROM disk controller plugs into ROM slot. Can mix 35 & 40 track disks up to 3 drives. Gives 184K/side or 368K bytes on-line when used with DD-3. Compatible with disk BASIC FLEX & OS-9. Comes with complete manual (J&M).  
~~\$149~~  
\$134

CA-1 Cable to connect disk to controller. Call or describe your configuration for correct cable.  
~~\$27.50~~  
\$24.75

Figure 1

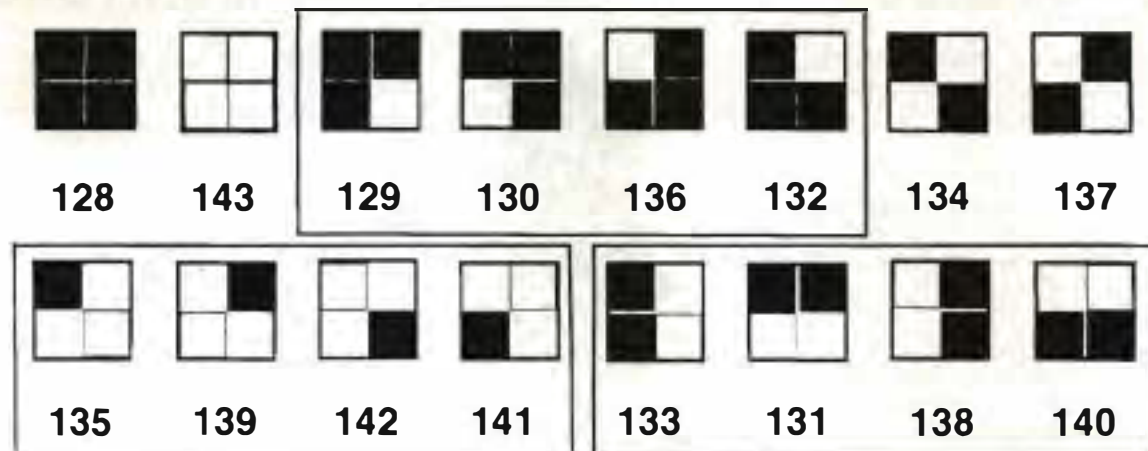

<b>PRINT@</b>	0	256
	32	288
	64	320
	96	352
	128	384
	160	416
	192	448
	224	480

	<b>COLOR</b>
<b>143</b>	+ 16 YELLOW
	+ 32 BLUE
	+ 48 RED
	+ 64 BUFF
	+ 80 CYAN
	+ 96 MAGENTA
	+112 ORANGE

VERSION II, LOWER PRICES!

## C.C. DIALER II



Automatic Touch-Tone Dialer Program. Store up to 126 names and numbers in each directory. Access MCI and SPRINT! Sort directory entries. Load and save any number of directories on Tape or Disk. Includes autostart loader. US orders Mailed in USA.

NO ADDITIONAL HOOKUP REQUIRED!!!

Requires Extended Basic (16k or more) and Touch-Tone Phone service.

CASSETTE VERSION \$21.95  
DISK VERSION \$25.95



Send check or money order to:

CHRIS COMPUTERS  
6299 Alderwood Lane,  
Delta, B.C. Canada V4E 3E7

( B.C. residents include 7% sales Tax)

This was done using concatenation, a long word that translates to [+] in BASIC. This is the sign for "adding to," but, unlike the plus sign, +7, it doesn't add something to change the total and thus becoming an invisible part of the result. In  $2+1=3$ , the resultant 3 has the hidden parts, 2 and 1.

Concatenation is always visible. Concatenating  $2+1$  results in 21. Both 2 and 1 are visible in the resultant 21.

If you created an "A" with a pointed top, an odd number of columns would be required—five in this case. The letters "I" and "T" require an odd number of columns. Remember, you will still use the 6 x 6 grid or matrix because an even number of columns must be used to fill in the entire *CHR\$* graphic character.

Make a sketch of the letter, "X," using six columns and then one that uses five columns. Which one do you like better?

In order to display the "A," we have a problem. Even though  $[AA\$=A\$+B\$+C\$]$  is a completed "A" in three component rows, it can't be printed using a simple program line. Type in and *RUN* lines 10-30; 500; 800. The top row is printed with the second row to the right of it, followed by the third row to the right of the second row. Interesting—but garbage!

The three rows that constitute the A must be printed one below the other.

Look in your manual at the "PRINT@ Screen Locations." Pick the row that starts just below the horizontal centerline—256. Notice you have the list on your handy training aid. Add one to 256 to leave a blank area at the left margin. Key in the following three lines:

```
800 PRINT@256+1,A$'top row
810 PRINT@288+1,B$'middle row
820 PRINT@320+1,C$'bottom row
```

*RUN*. Note you could have just as easily used *PRINT* @257; *PRINT*@289; *PRINT*@321. It is easier to refer to the starting number of each *PRINT*@ row and [+] whatever number you wish to move your A horizontally on the screen to a desired location. Try other numbers instead of [+] but be sure to add the same offset to all three rows.

To make a five column, pointed A to see how it compares with a six column, square top A, you get:

```
40 D$=CHR$(143)+CHR$(134)+CHR$(143)
50 E$=CHR$(132)+CHR$(140)+CHR$(133)
60 F$=CHR$(133)+CHR$(143)+CHR$(133)
500 A1$=D$+E$+F$
```

Change the variable in lines 800-820 to D\$; E\$ F\$ respectively. *RUN*. Which one do you like better?

It might be a good idea to compare them side by side. At the end of lines 800-820 add [;A\$], [;B\$], [;C\$] respectively. *RUN*. Hey, something's wrong! The two letters run into each other. Have no fear!

There are a few ways to remedy the problem. You could go back and add [+CHR\$(143)], an empty graphic block, to the ends of lines 10-60. A better way would be to create a variable, [SP\$], a spacer. Insert:

```
5 SP$=CHR$(143)
```

Instead of adding [+CHR\$(143)], 10 bytes of memory to each line, 23 add [+SP\$] and use four bytes per line. Another way would be to add, either [CHR\$(143)] or [+SP\$] after each variable in lines 800-820. It would be: 800 PRINT @256+1, D\$CHR\$(143); A\$+SP\$' example using both methods in a single line.

After you experiment, choose your solution. Adjust the program lines to reflect it and *RUN* the program. You may find both letters okay but wonder if there are other possible A's.

Try to design other shapes. Always try to alter or improve all problems. Keep trying variants until you run out of ideas.

Get out your scrap paper and sketch out some other A's. If you find some new design or format for an A, see which program lines are altered. Assign it a new variable name and add additional lines to your program. In lines 800-820, add the components at the end of the line, remembering to add a semicolon between variables. This indicates that the last variable is to follow to the right of the previous variable. *RUN* and see how it compares with the others.

A good idea is to change lines 500-510, by adding a REM so you can recall which set of variables constitute a specific form of A.

```
500 'A$+B$+C$ square top
510 'D$+E$+F$ pointed top
```

To keep you honest, no further hints will be given. In the next article, we will consider the letter A further and develop more information about expanding this core program, that you are in the process of creating. Make as many A's using this format to see how many you can come up with.

An added project for you is to create an entire alphabet. Fool around with it. You made two A's and are creating more variants. There is no reason for you not to create all the letters of the alphabet and have fun getting familiar with the graphic blocks.



**PEACOCK ENTERPRISES**

**ANSWER the QUESTIONS and CLAIM YOUR FREE GIFT**

- Who was one of the 1st 8 Subscribers to "the Rainbow"?
- Who was the 1st to tell Readers How To Output Text to the Screen & Printer simultaneously. Print Videotex Screens, and what the 6883 (SAM) chip is All About?
- WHO WAS 1st TO OFFER:
  - A mini-Data-Base for under \$20.00.
  - A Pac of Utilities at a Price Most Charge for Just 1 Program.
  - The C. Itoh ProWriter & at Wholesale Prices.
  - Direct Connect Modems & HI-RES Monitors for Under \$100.
- WHO IS the 1st to OFFER the NEW AMDISK III drives for Under \$450!
- WHO IS the 1st to OFFER 2716 EPROMs for Only \$2.50 ea or \$20/10!
- WHO IS the 1st to OFFER 2732A EPROMs for Only \$3.50 ea or \$30/10!

Send Your Answers along with \$1.50 (to cover shipping & handling) and Receive the following FREE GIFTS!

"The Secrets of Perfect Memory" by Elephant Memory Systems this booklet (80 pages) Contains Valuable Information for the Beginner and Pro alike.

Plus Valuable Discounts toward Future Purchases from Peacock. Free Catalog Upon Request!

PEACOCK ENT.  
194 CANNONGATE III ROAD  
NASHUA, NH 03063  
603-880-8169 Mon-Sat 10-10

**RAINBOW  
POSTER  
NOW  
AVAILABLE**



Yes, it's here! A beautiful full-color poster of the cover of our January issue!

This big (31x23) poster is printed on heavy poster paper and varnished to make it really shine. It is the perfect addition to your computer room and is available for only \$5. There's even a small Rainbow logo in one corner.

Send for yours today! There is only a limited supply, and when we run out, there won't be any more.

**Each poster is \$5, plus \$1.50 handling charge per order to same address in U.S. and Canada. Other points add \$3. U.S. Currency only. VISA, MasterCard and American Express accepted. Mail to: Rainbow Poster, P.O. Box 209, Prospect, KY 40059 or call (502) 228-4492.**



**SUPER STATS** — The most powerful statistics program available for the CoCo/TDP. Multiple linear regression, forecasting, mean, standard deviation, correlation coefficients, covariance, F and t tests. Powerful data editing and manipulation abilities. Data plotting, Student t tail areas, Gaussian cumulative probability distributions, and more. Flexible I/O (screen or printer, tape or disk). Very good documentation. 16K extended BASIC. Cassette \$29.95.

**STRUCTURED MACROS** — An assembly language programming tool for users of the Macro-80C assembler, by the Micro Works. Structured macros come close to transforming your assembler into a high-level language. Your programs become more understandable and debugging is simplified. Commands include IF, ELS, ENDIF, IFTST, IFCC, WHILE, ENDWH, REPEAT, and UNTIL. Disk \$19.95.

**PAGE PLUS** — Attention BASIC programmers! Up to 56K available from your BASIC programs. This utility, written by Chris Hawks, does the memory management necessary to utilize the two 32K banks of memory. Easy enough for any "intermediate" level BASIC programmer to use. Works with 64K systems. Cassette \$27.95. Disk \$29.95.



**MYSTIC MANSION** — New!! You'll be hearing lots about this incredible ALL GRAPHIC adventure. Explore the mansion and escape from the island, if you can! This one is tough to solve, but you'll have fun trying. For 32K Disk only. Disk \$29.95.

## C.C. Three

A powerful 'electronic spreadsheet', a full-featured word processor, and a flexible database - for an unheard of low price! This may be the **ONLY SOFTWARE PACKAGE YOU'LL EVER NEED TO BUY** for your computer.

**BOTH DISK AND TAPE VERSIONS OF ALL THREE PROGRAMS ARE INCLUDED** (on tape) for the bargain price of \$49.95! No need to pay for upgrades to disk later! Over 40 pages of documentation in an attractive vinyl binder. C. C. Writer and C. C. File require 16K, C. C. Calc needs 32K. All require Extended Color BASIC. Order yours **NOW!**

**MDISK** — Hal Snyder's latest breakthrough for the 64 Color Computer! MDISK lets you use the upper 32K of memory for rapid storage and retrieval of programs and data. Whether you own an actual disk drive or not, MDISK puts the "hidden" 32K to work for you as a "virtual disk," with capability to save and load up to 15 programs, view a directory of files stored in "page 1," kill unwanted page 1 files, execute BASIC or machine language directly from MDISK, chain to a BASIC program while preserving data already created, and more. MDISK is written in position independent code, and will work on disk or tape based 64K systems. Cassette \$27.95. Disk \$29.95.

**ROMBACK** — Why pay more? The easiest to use ROM-pak dumping utility available! At the best price, too! Comes with full documentation, including detailed patching instructions to allow several popular "problem" cartridges to run from tape or disk. 64K Extended BASIC. Cassette \$16.95.

**QUICKSORT** — A machine language sort routine specifically designed to be used by BASIC programmers. Written in position independent code, works on tape or disk systems. 16K required. Cassette \$12.95.

**64K BOOT/PAGER** — The 64K Boot allows you to modify BASIC by moving it from ROM to RAM. The PAGER is a menu-driven utility allowing you to manually page between the 32K banks of memory. Source code for both programs is included. Both run on 64K tape or disk systems. Cassette \$12.95.

**WIZARD 64** — If you've got 64K, then this one's for you! Uses both 32K pages of memory for graphics and action. Challenging enough for adults, yet entertaining for younger players too. 64K Extended BASIC. Cassette \$21.95. Disk \$23.95.

**SIMPLEX** — Linear programming by the "simplex" method now available for the Color Computer. This powerful decision making tool finds the optimum "mix" for a given set of constraints. Disk compatible. 16 page manual included. 16K Extended BASIC. Cassette \$29.95.

### ORDERING INFORMATION

\*\$10 shipping, handling, & insurance on printers. Amdisk, and monitors. \$5 on modems. \$2 on all other orders. All prices U.S. funds.

**We Love Canadian Orders!**  
Inquire For Foreign Shipping

Dealer Inquiries Invited

**Skyline Marketing Corp.**  
4510 W. Irving Park Rd.  
Chicago, IL 60641  
(312) 286-0762



## QUALITY SOFTWARE AND PERIPHERALS FOR YOUR COMPUTER

### AN ASTRONOMICAL ARRAY OF FEATURES FOR A DOWN-TO-EARTH PRICE

**MORE QUALITY:** 120 cps • thrupt time of 58 lpm • high resolution (120x144) bit image & block (6x6) graphics • extra fast forms feed

**MORE FLEXIBILITY:** super/sub script • underlining • backspacing • double strike mode • emphasized print mode • 816 character buffer • compatible with most software supporting leading printers • 10" carriage • 15" carriage Gemini-15 available

**MORE RELIABILITY:** 180 day warranty (90 days for head & ribbon)  
• mtbf rate of more than 5 million lines • print head life of more than 100 million characters

#### SAVE \$100.00!!!

Our incredible Gemini-10 package—a **PRINTING SYSTEM** ready to plug in to your Color Computer. **NOTHING MORE TO BUY.** Includes serial to parallel converter, graphic screen print software, deluxe user manual, and 5 minute setup instructions! A \$479.00 value. Complete package

Wide carriage Gemini—15 also available:

Package ONLY \$579\*

Printer only \$499\*

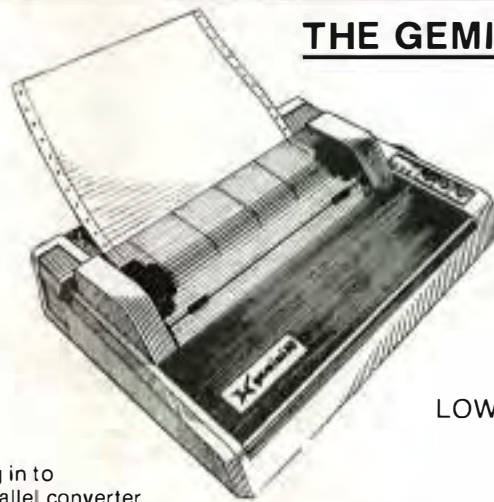

### THE GEMINI-10 X

NEW  
LOW PRICES!

**ONLY \$379\***

Order yours today!  
Parallel printer only. \$299



#### GET THE MOST FROM YOUR SYSTEM WITH AN NEC MONITOR PACKAGE!

Without a monitor, you'll never know just how good your graphics are. Word processing becomes less fatiguing, programming more enjoyable. NEC is famous for excellent color reproduction and tack-sharp resolution. We take the work out of adding the monitor to your system by including a custom plug-in monitor driver (with color, monochrome, and audio outputs), any required cables, and easy setup instructions. Buy with confidence—we've done the "homework" for you!

NEC 12" Color monitor (JC1212M) package ONLY \$389\*

NEC 12" Green-screen (JB1260M) package ONLY \$169\*

NEC 12" Amber screen (JB1205MA) package ONLY \$219\*

True lower-case and inverse video—just plug in the LCA-47. Special price with monitor purchase \$66.  
(not available for Color Computer 2)

#### GET SMART!! GREAT DEAL ON HAYES SMARTMODEMS

Hayes 300 baud Smartmodem—the amazing programmable auto-dial, auto-answer modem, now in a special package deal for your Color Computer. Buy the Hayes for list price, and at NO EXTRA CHARGE receive the Colorcom/E smart terminal program (cartridge or disk), an RS232 cable, and setup instructions! Act now!

Hayes 300 baud Smartmodem package ONLY \$289\*

Hayes modem with CC cable only, \$249\*

Signalman Mark I modem, 300 baud direct connect, list \$98, our price \$86\*



The revolutionary 3" disk system! Two compatible 156K drives in a compact enclosure. Uses the rigid, protected 2-sided cartridge that has made others obsolete. Our package includes the Amdisk III, cable, disk controller, Disk BASIC manual, 12 cartridges, setup instructions, and a ML tape to disk program to help transfer your software! Everything you need, plus you save \$50!

Package price ONLY \$689\* Amdisk III plus cable only \$479\*

Order Now!! (available for Color Computer 2, please specify)

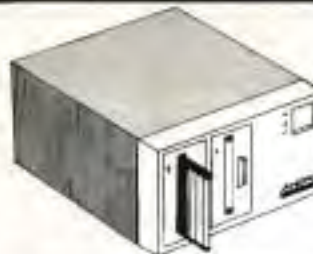

SALE ON  
AMDISK III  
DISK SYSTEM!!



UPS C.O.D. orders gladly accepted,  
\$2.00 additional.

### SKYLINE 64K Memory Upgrade Kits

8 guaranteed 200 n.s. 64K memory chips, solderless installation instructions, Skyline's 64K BOOT and PAGER programs (a \$19.95 value). All for the super low price of \$59.00! Order yours today!  
(soldering required on Color Computer 2)

# CoCo Community

**W**e are compiling a list of Color Computer Clubs because of the many requests we have received. The CoCo Clubs may want to exchange newsletters, share ideas for topics of discussion at monthly meetings; etc.

Please let us know if we have omitted any clubs and send us complete up-to-date addresses. Only those clubs who have signed our "agreement form" will appear in this listing of CoCo Clubs. Also, please notify us if you wish to add or delete any names on this list. Send your information to:

CoCo Clubs  
the Rainbow  
9529 U.S. Highway 42  
P.O. Box 209  
Prospect, KY 40059

## ALABAMA

Birmingham Alabama Color Computer Club, Robert Matthews, 1725 14th Ave. S., Birmingham 35205, (205) 933-0887

## ALASKA

Alaska Color Computer Users' Group, Rick McDannel, 430C Beluga Ave., Ft. Richardson 99505, (907) 428-0392

## ARIZONA

Tucson 6809 CoCo Club, Steve Parkman, 902 S. Kolb Rd. Tucson, 85710, (602) 747-8233

## ARKANSAS

Central Arkansas CoCo Club, Melinda Braslovsky, 1203 Erving Rdg., LP Cabot, 72023, (501) 982-8854

## CALIFORNIA

CoCoNutz Computer Club, Walter V. Seay, 68-461 Highway 86, Thermal, 92274, (619) 397-4252

Citrus Color Computer, Joseph Kohn, P.O. Box 699, San Bernadino, 92412

Joe Bennett, 1169 Florida Street, Imperial Beach, 92023, (474-6213)

Local Color, A CoCo Club of San Francisco, Andrew G. Kieval, P.O. Box 421242, San Francisco 94142

Los Angeles CoCo Users Group, Mark Randall, 2227 Canyon Rd., Arcadia, 91006, (213) 355-6111

Los Angeles-Wilshire Color Computer Users' Group, c/o Norm Wolfe, 269 S. Lafayette Park Pl., Los Angeles, 90057

Sacramento Color Computer Club, Wayne Chrisope, Pres., P.O. Box 9, Elverta, 95626

Silicon Valley Color Computer Club, Shaw Jipp, Pres., P.O. Box 61593, Sunnyvale, 94088, (408) 749-1947

South Bay Color Computer Club, Karen Schlotzhauer, 2545 W. 255th Place, Torrance, 90505, (213) 539-2439

Ventura County Color Computer Club (VC4), c/o Pete Lydall, Oxnard Public Library, 214 "C" Street, Oxnard, 93030, (805) 984-1842 or DATA (805) 984-1842

## COLORADO

Lowry Microcomputer Club/CoCo Users' Group, Jerry D. Surritte, 2249 Moline St., Aurora, 80010, (303) 343-3273

## FLORIDA

Broward CoCo Club, Sue Spahn, 11950 N.W. 29th FL 33582, (305) 741-4737

C.C. Club of Sarasota, Ernie Bontrager, 4047 Bee Ridge Rd., FL 33582, (813)921-7510

Jacksonville Color Computer Club, William H. Brown III, 2411 Hirsch Ave., Jacksonville, 32216 (904) 721-0282

Northwest Florida CoCo Nuts, William N. Lamb, Pres., P.O. Box 1032, Fort Walton FL 35249, (904) 244-5281

## ILLINOIS

Motorola Microcomputer Club, Steve Adler, Pres., 1301 Algonquin Rd., Schaumburg, 60196, (312) 576-3044

Quad City CoCo Club, John Greve, Pres., 4211 Seventh Ave., Rock Island, 61201, (309) 786-8187  
Town & Country CoCo, Kenwood, Chicago, (312) 493-3748

## INDIANA

Southern Indiana Computer Club, Route 1, Box 459, Mitchell, 47446

Three Rivers Users Group, Russ Garner, 533 Villa Park Ct., Fort Wayne, 46808

## IOWA

Iowa City TRS-80 Users Group, Susan Chapler, R.R. 6, The Woods, Iowa City, 52240, (319) 351-5959

## KENTUCKY

Roger Idstrom, 2603 Garden Lake Lane, Louisville, 40220, (502) 491-1853

Lo-CoCo Club Liason, 2820 Del Rio Place #27, Louisville, 40220, (502) 458-0649

LOCO-COCO, c/o Mike Standefer, 3141 Doreen Way, Louisville, (502) 458-6990

## LOUISIANA

Red Stick Color Computer Club, Gary Cash, Pres., 8929 Metairie Drive, Baton Rouge, 70810, (504) 293-7799

## MASSACHUSETTS

New England C.C. Users Group, Christopher E. Sweet, P.O. Box 255, Harvard, 01451, (617) 456-8291

Massachusetts CoCo Club, Jason Rahaim, Spring St., Lunenburg, 01462, (617) 582-6514

## MICHIGAN

Greg Miller, P.O. Box 365, Haslett

Midland C.C. Club, Neil Drake, 709 Coolidge, Midland, 48640, (517) 631-2939

Michiana CoCo Club, Clay Howe, 310 S. Jefferson St., Sturgis, 49091, (616) 651-4248

## MISSISSIPPI

Singing River C.C. Club, Jerry P. Lowe, Sr., 2500 Fairly Road, Gautier, 39553

## MISSOURI

North County 80 Group, Tom Vogel, 12 Ville Donna Ct., Hazelwood, 63042, (314) 739-4078

## MONTANA

Billings C.C. Club, Jayne Kenyon, 4306 Phillip Billings, 59101

## NEW JERSEY

Bug 80 Users' Group, George R. Miller, Jr., Box 62, Glen Gardner, 08826

Loco CoCo Club, Bud Lavin, 73B Wavercrest Ave., Winfield Park, 07036

## NEW YORK

Adirondack CoCo Club, Bill Edwards, Box 365, Bolton Landing, 12814, (518) 644-9927

Broome CoCo Club, Bucky Helmer, 57 Front St., Binghamton, 13905

C.C. Club of Central N.Y., Joseph Short, 248 S. Fourth Ave., Ilion, 11357, (315) 895-7730

Kings Byte CoCo Club, Morty Libowitz, 1063 East 84th St., Brooklyn, 11236, (212) 763-4233

## NORTH CAROLINA

TRS-80 Users' Group of Charlotte, Bill Hardin, 6613 Summerlin Pl., Charlotte, 28226, (704) 542-9959

Raleigh Color Computer Club, David Roper, P.O. Box 681, Garner, 27529

## OHIO

CoCo Club of Youngstown, Timothy McFadden, P.O. Box 478, Canfield, 44406, (216) 788-4218

Cincinnati TRS-80 Users Group, R.A. White, 44 Dow Court, Fairfield, 45014

Dayton Area Color Computer Users' Group, Hal Brown, Sec., 5700 Troy Villa Blvd., Huber Heights, Dayton, 45424

Dayton CoCo Users' Group, Joseph P. Evans, 609 Applehill Dr., W. Carrollton, 45449

Miami Valley CoCo Club, R. Douglas Wales, Pres., 2065 Le Feure Rd., Troy, 45373

The Cleveland CoConuts, Paul Selig, 20734, Stanford Ave., Fairview Park, 44126, 333-2920

## OREGON

Willamette Valley CoCo Users, Brian James, P.O. Box 11468, Eugene, 97440, (503) 687-9286

## PENNSYLVANIA

Penn-Jersey Color Computer Club, Jerry Behler, 1231 Walnut St., Allentown, 18102, (215) 253-1238

Pittsburgh Color Group, William Tucker, P.O. Box 351, West Mifflin, 15122, (412) 466-3078

## RHODE ISLAND

New England CoCo Nuts Color Computer Club, Eugene E. Bouley, Jr., Pres., P.O. Box 3165, Wayland Square, Providence, 02906

## SOUTH CAROLINA

Midlands 80 Computer Club, Robert Rose, P.O. Box 7594, Columbia, 29202, (803) 776-4361

Metropolitan Greenville CoCo Club, Ed Lowe, P.O. Box 6, Gray Court, 29645, (803) 876-3928

## TENNESSEE

Chattanooga CoCo Club, Jim Perkins/Jim Cox, P.O. Box 9825, Chattanooga, 37412, (615) 870-2439

Memphis Color Computer Users' Group, Ben Barton, Pres., 4903 Warrington Rd., Memphis, 38118, (901) 795-7075 or 362-5945

## TEXAS

CoCo User Group, David Karam, 1809 Dexter, Austin, 78704, (512) 442-6317

International Color Computer Club, Inc., Ronald L. Garrett, Pres., 2101 East Main Street, Henderson, 75652, (214) 657-7834

## UTAH

Ogden CoCo, Kathy Rush, 4535 S. 2600 W. Roy, Ogden, 84067

## VIRGINIA

D.C./N. Va. C.C. Club, Jack Darling, 43 Donovan Dr., Alexandria, 22306, (703) 780-6159

## WASHINGTON

Northwest Computer Club, Judy Gehman, E. 14012 Cataldo, Spokane, 99216, (509) 928-2169

## WEST VIRGINIA

Mtn. State CoCo Users Group, Donald G. Barber, Jr., P.O. Box 295, Granville, 26534, (304) 599-4493

Mil-O-Bar C.C. Club, Jim Lemaster, Milton, (304) 743-4752

Blennerhassett CoCo Club, David Greathouse, Rt. 9, Box 119, Parkersburg, 26101

## WISCONSIN

Southern Wisconsin CoCo Club, David C. Buehn, P.O. Box 411, Twin Lakes, 53181

## CANADA

### ALBERTA

Medley Computer and Electronics Club, P.O. Box 1267, Medley, T4A 2M0

### NEWFOUNDLAND

Avalon CoCo Club, Mr. A.R. Thompson, Chairman, 10 Foran St., St. John's, A1E4G1

### NOVA SCOTIA

Halifax Dartmouth CoCo Users Group, P.O. Box 572, Dartmouth, B2Y 3Y9, (902) 469-3656

### ONTARIO

K-W C.C. Club, Peter Karwowski, 23 Hudson Cr., Kitchener, N2B 2V7

International Adventurer's Club, Maurice Dow, 84 Camberley Cres., Brampton, L6V 344

### QUEBEC

Montreal TRS-80 Users Group, Jacobus P.C. Bagchus, Pres., 1176 Phillips Place, Suite 201, Montreal, H3B 3C8, (514) 861-3488

### SASKATCHEWAN

Saskatoon Color Computer Club, Guy Tomashewski, 415-423 Pendency Rd., Saskatoon, S7M 4Z2

### MEXICO

Mexico City Color Computer Club, Marcelo Lufi, Laja #232, 01900 Mexico D.F., Mexico City, 5-68-78-75

# CoCo Clubs

## new clubs

**Editor:**

I want to start a users group in the Savannah-Hinesville area. Anyone interested can phone me at (912) 368-3900 or write me at 417 Timber Lane Circle, 31313.

*William Mason  
Hinesville, GA*

**Editor:**

On behalf of other CoCo enthusiasts, I would like to invite groups and individuals in the U.S. to correspond with fellow users in Australia.

We read with envy each month about the enormous amount of software and hardware available to your readers in the States. By communicating with interested people, we may find ways to overcome some of the problems in getting that great stuff out here.

Thus by creating this "bridge" between our countries we hope to obtain and exchange information and ideas on the fantastic Color Computer.

Any initial contact can be made by writing to me c/o Penrith Users Group, 16 Tent Street, 2750 N.S.W.

*David Cunningham  
Kingswood, Australia*

**Editor:**

I am writing to announce the formation of a new international Adventurer's Club for all CoCo users interested in playing or writing Adventure programs. Members will maintain contact through a monthly newsletter.

For more information contact me at 84 Camberley, Cres., Brampton, L6V 3L4, or call me at (416) 451-9452.

*Maurice Dow, Ph.D  
Ontario, Canada*

**Editor:**

I would like to inform your readers of the Peoria Color Computer Club for the Color Computer users in Peoria, Ill. and the surrounding area. We meet on the second and fourth Saturdays of each month at 10 a.m. at the Germantown Hills Fire Station in Germantown Hills, Ill. For further information please contact me at 102 Twin Oaks Ct., 61611 or call (309) 694-4703.

*Harold E. Brazee  
East Peoria, IL*

**Editor:**

We are forming a Color Computer Club in the St. John's Newfoundland area. For more information contact either Rollie Thompson at 10 Foran Street, A1E 4G1, or phone him at (709) 579-0883. You can also contact me at 33 Slaterry Road, A1A 1Z7 or call me at (709) 722-1554 between 6 and 10 p.m.

*Robert D.C. Taylor  
Newfoundland, Canada*

**Editor:**

We are starting a Color Computer Club serving the Acadiana, La., area. Our club is called "Cajun CoCo Club" and open to TRS-80 Color Computer, MC-10, TDP-100, Dragon, and other 6809 users. For more information call or write to me at 104 Karen St., 70560, or phone (318) 365-7706.

*Bob Hoevel  
New Iberia, LA*

**Editor:**

The management of Saturnus True Data Services, Ltd., is proud to announce the forming of a new users' group in Montreal. We feel that this group fills a great need in this fine city and that we will enjoy a successful future.

As an announcement in your magazine, we would like to briefly point out some of the advantages of joining us and outlining a few services that can be enjoyed by anybody anywhere, if he/she wills.

A member of MTUG will enjoy our down time service which simply entails the use of another member's equipment as long as his/hers is indisposed. Also our members enjoy a purchasing service; anything the member buys through the club is charged at a discount. Members (anywhere) have use of our exclusive Bulletin Board System which includes a "classified ad" department and electronic mail. A newsletter is also published bimonthly and is available to anybody who wants it. Members get a free subscription to it. Advertising is also accepted from anybody at a nominal rate. This makes MTUG unique in Montreal.

Montreal TRS-80 Users Group, 1176 Phillips Place, Suite 201, Montreal, H3B 3C8.

*William P.H. Bagchus  
Quebec, Canada*

**Editor:**

Even in the backwaters of old (but great) England we devour your magic magazine for its CoCo nutritional value. So, would you please give mention to our users club, The TRS-80 Colour Computer User Group. (Yea, we spell different, too!) Interested limeys should contact Ian Wild at 53 Darnton Rd., Ashton Under Lyne, Lancashire, England. Regards to the New World!

*Robert Tinckler  
Berkshire, England*

**Editor:**

I am proud to announce the formation of a new club, the "Red Stick Color Computer Club."

This is the first CoCo club in the state of Louisiana.

Any suggestions or help from other clubs will be greatly appreciated.

For more information contact me at 8929 Metairie Dr., 70810, or call (504)293-7799.

*Gary Cash  
Baton Rouge, LA*

**Editor:**

I am interested in forming a Color Computer Club on Long Island, or joining an already existing one. Anybody

with information, please contact me at 9 Stalker Lane, 11733 or phone (516)928-7324.

*John Enriquez  
E. Setauket, NY*

**Editor:**

I would like to form a Color Computer Club in the Santa Clarita Valley (Newhall/Valencia/Canyon County/Sagas) in California. Any person interested may contact me at 23920 Fambrough St., 91321, or call (805) 254-0924.

*David Barry, Jr.  
Newhall, CA*

**Editor:**

Please publish notice that a new club for the Color Computer is being formed. Those interested in becoming involved in the Pocomo Home Computer Club may contact me at 705 Sarah Street, 18360 or call (717) 421-8762.

*Kenneth VanCamp  
Stroudsburg, PA*

**Editor:**

I would like to announce a Kids' CoCo Users' Group. We exchange programs and miscellaneous ideas about the CoCo. Write me at 1301 Francis, 77840.

*Larry Darcey  
College Station, TX*

**Editor:**

I live in Bayville (Ocean County), but go to school in Wayne. If anyone is interested in a club in Ocean County write me at 32 Pine Tree Dr., 08721, or call (201) 269-2054, or in North Jersey, William Paterson College, Heritage 210, Wayne, 07470.

*John Knam  
Bayville, NJ*

**Editor:**

I am forming the Northwest Indiana Color Computer Club. Anyone interested can contact me at 1336 E. Elm #10, 46319, or call (219) 923-0584, or contact George Sievers, 3373 W. 80th Ave., Merrerville, Ind., 46410, or call (219) 769-2033.

*Fred Kotynski  
Griffith, IN*

**Editor:**

I am interested in forming a CoCo users club in the Knoxville area. The club would include instruction in working with machine language and creating graphics. People interested should send their name, address and phone number to me at CoCo Users' Club, 10500 Sandpiper Ln., 37922.

*Nick Bradbury  
Knoxville, TN*

**Editor:**

Can someone tell me if there is a CoCo Club in the Grand Rapids area? I have been active with CoCo Mug in Milwaukee until transferred to Michigan and would be interested in forming a users group here. Anyone interested in sharing experiences and knowledge of CoCo software and hardware contact me at 3908 Milan SW, 49509, or phone (616) 532-9290.

*Mike Kwas  
Wyoming, MI*



# What Is Your Compatibility Rating?

By Simon Clift

This is a program I have wanted to write for a long time, but a couple of weeks ago an idea struck me that really made sense. If you wanted to write a program that tested your compatibility with another person, your questions would have to be on those things that couples found most annoying. I mean, forget nuclear arms, how many kids to have, or financial dealings, anyone can agree on those earthshakers. You have to get down to the nitty-gritty things that bother people who live around each other.

I developed this program following surveys of many couples to see what bothered them most. As a result it reflects some of the most aggravating little things.

The format is as follows:

10—15	Credits
20—90	Set-up and instructions
100—410	Questioning routine
420—440	Answer subroutine
450—550	Analysis

Try this program on your friends at a party perhaps. Also, if you like, you could add a routine to save the results on disk or tape for a dating service program, or just for fun to see if you and that special person were "meant to be." Anyhow, I hope you enjoy it.

Rainbow Check Plus

120	.....02B7	141
190	.....063C	149
240	.....095F	230
300	.....0CCB	89
380	.....105E	138
END	.....1416	73

The listing:

```

10 'COMPATIBILITY TEST
12 'BY SIMON CLIFT
13 '1095 WITHERS CRES.
14 'KINCARDINE, ONTARIO
15 'CANADA NOG 260
20 PCLEAR1: CLEAR 2000
30 DIMAN$(1,25)
40 CLS:PRINT"ARE YOU TWO MEANT TO BE?"
50 PRINT:PRINT" THIS IS A TEST T
    
```

*(Simon Clift is a 16-year-old student at Kincardine District Secondary School, Kincardine, Ontario. He has had several programs published with Prism Software, and has owned his CoCo for 1½ years.)*

```

0 SEE IF YOU AND YOUR VIP ARE
COMPATIBLE."
60 PRINT" THIS TEST WILL ASK YOU
TWENTY- FIVE QUESTIONS WHICH YO
U MUST ANSWER HONESTLY."
70 PRINT" YOU ARE TO TAKE THE TE
ST FIRST, THEN YOUR VIP. AND NO
PEEKING AT THE OTHER ONE'S ANSW
ERS!!!"
80 PRINT:PRINT"PRESS ANY KEY TO
BEGIN..."
90 IF INKEY$="" THEN 90
100 FORI=0TO1
110 CLS:PRINT"WHAT'S YOUR FAVOUR
ITE PIZZA TOPPING:"
120 PRINT"1. MUSHROOMS":PRINT"2.
PEPPERONI":PRINT"3. ANCHOVIES":
PRINT"4. GREEN PEPPERS":PRINT"5.
SAUSAGE":PRINT"6. A COMBONATION
OF THE ABOVE 7. SOMETHING ELS
E"
130 QN=1:NA=7:GOSUB 420
140 PRINT"1. I LIKE THE BED COVE
RS TUCKED IN WHEN I SLEEP.":P
RINT"2. NO, I LIKE THEM PULLED O
UT.":QN=2:NA=3:GOSUB 420
150 PRINT"IF SOMEONE ASKS MY AGE
I MOST OFTEN.":PRINT"1. TELL
THE TRUTH":PRINT"2. DON'T TELL T
HE TRUTH":PRINT"3. AVOID ANSWERI
NG":QN=3:NA=3:GOSUB 420
160 PRINT"IF I HAD A CHOICE OF T
HREE POSSIBLE DESTINATIONS
ON A FREE HOLIDAY, I WOULD CHOOSE
":PRINT"1. LONDON, ENGLAND":PRI
NT"2. HAWII":PRINT"3. SYDNEY, AU
STRALIA":QN=4:NA=3:GOSUB 420
170 PRINT"1. I THINK THAT TEACHE
RS HAVE NO RIGHT TO HIT KIDS":
PRINT"2. I THINK THEY SHOULD STR
IKE CHILDREN IF THE OCCASIO
N REQUIRES":QN=5:NA=2:GOS
UB420
180 PRINT"1. TOILET PAPER SHOULD
BE HUNG SO THAT IT COMES OF
    
```

# Custom Software Engineering, Inc.

807 Minutemen Causeway (D-2), Cocoa Beach, Florida 32931  
(305) 783-1083

For information or technical support, please call between 5:30 and 8:30 P.M. Eastern time

\*RAINBOW  
REVIEW DATES

\*RAINBOW  
REVIEW DATES

\*JAN '83

\*NEW

**DISK DOUBLE ENTRY** - If you have spent hours trying to balance your Debits and Credits, this program is for you! Designed for small business, club, and personal use. Enter transactions in a journal type format. Program will maintain current account balances, produce Trial Balance, Income, and Balance Sheet reports and complete Account Ledgers. Will handle up to 300 accounts including report headings and totals. Up to 1400 average transactions on a diskette. Summary reports and four levels of subtotals available. REQUIRES 32K and a user understanding of standard double entry accounting concepts. - \$44.95 in BASIC with Machine Language subroutines.

**COMMAND STREAM PROCESSOR** - Adds a new dimension to the power of your Color Computer! A program to run your other programs. Will allow you to prepackage a stream of direct system commands as well as INPUT and LINE INPUT to your BASIC program. This results in a totally automated stream of activity. If you understand your computer and the flow of activity required for your total operation, you are ready for the power of Command Stream Programming. In completely relocatable Machine Language - \$19.95.

\*DEC '83

**STATEMENT WRITER** - For use with (and requires) Disk Double Entry. Produces statements suitable for billing from your Receivable accounts. Provides mailing labels to use with your statements and account summaries. Designed and documented to allow you to change formats to accommodate your own special needs. \$34.95.

**That's INTEREST-ing** - Time to let your computer do some real computation! This program will help you solve problems dealing with time, money, and INTEREST. Calculates present value, future value, and capital recovery for any combination of payments you specify. Rate of Return computation to predict how hard your money will be working. Special section to compute bond yields (current and to redemption). Amortization schedules about any way you want them - even allows you to change terms in mid schedule! All answers available on screen or printer. \$29.95 in BASIC.

\*OCT '82

**DISK DATA HANDLER - 64K** - Designed to use the full 64K RAM, but may also be configured for 32K. Uses standard ROM's - No special operating system required! Allows you to design disk data files for your specific needs. You define a basic record of up to 14 fields and 246 characters. Provides fast selection and sorting based on any field or combination of fields in this record. Powerful on screen input and update. User defined output of reports to screen, printer, or disk files which may be read by your BASIC programs for any computational or special formatting requirements. Printer reports allow headings, page breaks, and page numbering, and let you pass control codes to drive your printer's special features. Maximum number of records you may work with at one time will depend on RAM configuration and record size - 64K (32K) 1850 (500) - 21 char records, 179 (49) - 246 char records. An optional Extended record linked to the basic record may also be defined. The size of this Extended record is not a factor in determining maximum number of records. Will provide the growth capability needed for your increasingly sophisticated applications. NOW - also includes a listing of a short program to read directory information from your disks and produce a combined file index. \$54.95 in BASIC with Machine Language subroutines.

**MATH TUTOR** - Five programs that go from math fact (+, -, X, /) drill to full addition, subtraction, multiplication, and division at four levels of difficulty. Provides a step by step approach with error correction and rewards for good performance. - \$13.95 in BASIC.

\*JUNE '82

**DATE-O-BASE CALENDAR** - Puts you in charge of your schedule! Graphically displays any monthly calendar between 1700 and 2099. You put in up to twelve 28 character memos per day - calendar shows where the memos are - call up of day shows details. Use for appointments and a log of past activity. Study the chronology of the American Revolution or note the day your mortgage will be paid off. Search capability allows you to list or print all memos between two specified dates or only ones meeting key word criteria. Date computation shows elapsed time between two dates in days, weeks, months, and years. REQUIRES 32K in BASIC.

**SPELLING TEACHER** - Up to 200 of their spelling words stored on tape or disk are presented in four lively study modes including a scrambled word game. - \$12.95 in BASIC.

**ALPHA-DRAW** - A subroutine designed to let you easily add characters to your graphic displays. You define X and Y coordinates and a string variable of one or more characters and Alpha-Draw will do the rest. Includes all keyboard characters. Comes with instructions for a true line numbered merge of tape files. Works great with the Screen Print program! - \$8.95 in BASIC.

**GRAPHIC SCREEN PRINT PROGRAM** - Works in ALL PMODES and lets you shift screen image anywhere on the printed page. Relocatable code lets you use all of your 16K or 32K machine. Available for Color Basic 1.0 and 1.1/1.2. Use EXEC 41175 to see which you have and SPECIFY with order. In Machine Language.

SPECIFY PRINTER TYPE

**\$7.95** - For TRS-80<sup>+</sup> LP-VII/VIII & DMP 100/200/400/420.

**\$9.95** - For Epson GRAFTRAX<sup>+</sup>, NEC<sup>+</sup> PC 8023 A-C, IDS-440/445, Paper Tiger<sup>+</sup> 460/560, Micro Prism<sup>+</sup> 480, Prism<sup>+</sup> 80/132 (with dot plotting), TRS-80<sup>+</sup> DMP-120, TDP-1, Micro Peripherals, Inc. 88G/99G, PROWRITER<sup>+</sup>, Centronics 739, Mircoline<sup>+</sup> 82A/83A (with OKIGRAPH I) /84/92/93, Star Micronics, Inc. GEMINI 10/10X/15 and Gorilla Banana. (Trademarks of Tandy Corp., Epson America, Inc., C-Itoh, NEC America, Okidata Corp., Integral Data Systems, Inc.)

**TAPE DATE-O-BASE CALENDAR** - \$16.95 - (max. 400 memos/tape file).

**DISK DATE-O-BASE CALENDAR** - \$19.95 - (over 4,000 memos/disk - max. 300 memos/month).

ALL PROGRAMS require Extended Color Basic and are delivered on cassette. All, except Tape Date-O-Base Calendar, are DISK System compatible.

U.S. and CANADA add \$1.00 per order for shipping. Overseas \$2.50 per order. All prices in U.S. dollars. Florida residents add 5% sales tax. Return within two weeks if not completely satisfied.



For VISA and Master Card orders: Include type, account number, expiration date, signature and phone number. Sorry! No COD's.



THE TOP OF THE ROLL.":PRINT  
 "2. NO, IT SHOULD COME OFF THE  
 BOTTOM OF THE ROLL.":QN=6:NA  
 =2:GOSUB 420  
 190 PRINT"WHEN DRIVING ON AN OPE  
 N HIGHWAY I USUALLY GO:":PRINT"1  
 . BELOW THE SPEED LIMIT":PRINT"2  
 . AT THE SPEED LIMIT":PRINT"3. A  
 BOVE THE SPEED LIMIT":QN=7:NA=3:  
 GOSUB420  
 200 PRINT"1. PARTIES ARE FUN TO  
 GO TO, BUT I HATE THROWING THE  
 M.":PRINT"2. I LIKE TO THROW PAR  
 TIES, BUT I HATE TO GO TO THE  
 M.":PRINT"3. I THINK IT'S FUN TO  
 BOTH GO TO AND THROW PARTIE  
 S.":PRINT"4. I DON'T LIKE PARTIE  
 S AT ALL.":QN=8:NA=4:GOSUB 42  
 210 PRINT"I THINK THAT AFTER WAT  
 ERGATE, RICHARD NIXON:":PRINT"  
 1. GOT WHAT HE DESERVED":PRINT"2  
 . SHOULD HAVE GOTTEN LOTS WORSE3  
 . WAS RAILOADED":QN=9:NA=3:GOSU  
 B 420  
 220 PRINT"1. I ENJOY EATING SPIC  
 Y FOOD.":PRINT"2. I HATE SPICY F  
 OOD.":QN=10:AN=2:GOSUB 420  
 230 PRINT"1. I USUALLY TEND TO L  
 EAVE CLOSET DOORS, AND D  
 RAWERS OPEN A BIT":PRINT"2

. SLOB, I CLOSE THEM ALL THE  
 WAY.":QN=11:NA=2:GOSUB 420  
 240 PRINT"1. I LIKE TAKING PHOTO  
 S OF PLACES I'VE BEEN, F  
 AMILY, AND FRIENDS.":PRINT"2.  
 PHOTOGRAPHS BORE ME, I'M MORE  
 INTERESTED IN THE PEOPLE AND  
 PLACES THEMSELVES.":QN=12:NA=2:G  
 OSUB 420  
 250 PRINT"IF I WANT A LOAF OF BR  
 EAD OR A MAGAZINE, AND I'M LESS  
 THAN ONE MILE FROM THE STORE, I  
 USUALY":PRINT"1. DRIVE":PRINT"2  
 . BICYCLE":PRINT"3. WALK":PRINT"  
 4. FIND SOMEONE ELSE TO GO":QN=1  
 3:NA=4:GOSUB 420  
 260 PRINT"1. THERE'S NOTHING WRO  
 NG WITH AN AFTER-DINNER SNACK.  
 ":PRINT"2. I NEVER EAT AFTER DIN  
 NER TILL BREAKFAST.":QN=14:NA=  
 2:GOSUB 420  
 270 PRINT"1. I'D GO BOWLING RATH  
 ER THAN TO A DANCE.":PRINT"  
 2. NO, DANCING IS MUCH MORE FUN  
 3. ARE YOU KIDDING? I WOULDN'T  
 BE CAUGHT DEAD DOING EITHER":  
 QN=15:NA=3:GOSUB 420  
 280 PRINT"1. I EAT BREAKFAST AS  
 SOON AS I GET UP.":PRINT"2. I  
 HAVE TO BE UP AWHILE BEFORE I

# Saguaro Software

## Petrocci Freelance Associates (tape)

<b>Tycoon</b>	14.75
Heart-Lung-Circ Systems	26.75
Bowling Secretary	19.75
Dunk A Duck	14.75
Inspector Clueseau	14.75
Stagecoach	14.75
For The Kids	
Big-Bigger-Biggest	7.75
ABC's	7.75
123	7.75
Shapes	7.75

## Sugar Software

Great U.S.A.	15.75
Bible Stories (Old Test.)	15.75
5 Stones - Children's Adventure	
Silly Syntax (tape)	15.75
Silly Stories	8.75
Prerecorder	15.75
<b>Tom Mix</b>	
Space Shuttle	21.75
Buzzard Bait	21.75
CU*BER	21.75
Journey To Mt. Doom (disk)	21.75
Air Traffic Controller	21.75
32K-Cassette Only	

Disk Add \$3.00, Amdek Add \$6.00

## Prickly-Pear

<b>Varalyzer 64K</b>	18.75
Tape Omniclone	29.95
Decipher	18.75
Music Reader	26.75
Flight (sim)	14.75
Super Astrology	18.75
Gangbusters	14.75
C-15 tape - 75¢ each/10 for \$7.00	
Paper - 500 sheets \$5.95 plus shipping	

## New From Saguaro Software

Our First Program

### MOVE-IT!

Are you tired of "saving" each Rainbow On Tape® to the disk? Stop! This ML program will do it automatically! Simply load Move-It! Execute, press play on the recorder, sit back and watch. \$15.95

Look next month for a few new programs from Saguaro Software. Authors! Contact us about royalties. ★ Dealer inquiries invited.

Az. Residents Add 7% Tax • Add \$1.00 Per Program For Shipping (\$4.00 Max.)

Some Quantities Limited

7331 E. Beverly - Tucson, AZ 85710 - (602) 885-6508



## Continued Low Price

Amdek Dual 3" Disk Drive

**\$475.00**

(Retail \$599)

Includes 2 Drive Cable  
And 2 Diskettes

Plus Shipping

First Box Of 10 3" Disks -  
\$45.00

## Don't be Fooled!

We sell only genuine Radio Shack Disk Controllers and Amdek Cables.

10-3" diskettes - \$55.00  
R.S. disk controller, \$135 with  
Amdek, \$165 alone.  
R.S. disk manual - \$12.00

```

START EATING.":PRINT"3. I RAREL
Y EVER EAT BREAKFAST.":QN=16:NA=
3:GOSUB 420
290 PRINT"AT A FOREIGN MOVIE I P
REFER:":PRINT"1. WRITTEN SUBTITL
ES":PRINT"2. DUBBED VOICES":QN=1
7:NA=2:GOSUB 420
300 PRINT"1. I OFTEN GO TO BED A
FTER MID- NIGHT":PRINT"2. ME?
ONLY SOMETIMES.":PRINT"3. NO, I
RARELY STAY UP THAT LATE.
":QN=18:NA=3:GOSUB 420
310 PRINT"1. THINK THINGS LIKE R
EMOTE CONTROL TV AND AUTO
GARAGE DOOR OPENERS ARE PA
RT OF TODAY'S KIND OF LIV
ING.":PRINT"2. NONSENSE, HEALTHY
PEOPLE WHO USE THAT KIND OF
THING ARE LAZY!":QN=19:NA=2
:GOSUB 420
320 PRINT"1. I ENJOY HAGGLING MY
WAY TO A BETTER PRICE.":PRIN
T"2. I NEVER DO, IT EMBARRASES M
E.":QN=20:NA=2:GOSUB 420
330 PRINT"1. I'M FOR CAPITAL PUN
ISHMENT.":PRINT"2. EXECUTIONS AR
E ONLY JUSTIFIED IN SOME CASES
.":PRINT"3. CAPITAL PUNISHMENT S
HOULD BE BANNED!":QN=21:NA=3:
GOSUB 420
340 PRINT"1. BALLET PUTS ME TO S
LEEP!":PRINT"2. BALLET? I LOVE B
ALLET!":QN=22:NA=2:GOSUB 420
350 PRINT"1. I DON'T LIKE PEOPLE
TO BE OVERWEIGHT.":PRINT"
2. OH, THERE'S NOTHING WRONG
WITH BEING 10-20 POUNDS OVER.
":QN=23:NA=2:GOSUB 420
360 PRINT"1. I THINK DRESSING UP
IS A PAIN2. I LOVE FANCY DRESSI
NG NOW AND THEN.":QN=24:NA=2:G
OSUB 420
370 PRINT"1. IT IS CORRECT TO SA
Y TOMAYTO":PRINT"2. NO, ONE SHOU
LD SAY TOMAHTO":QN=25:NA=2:GOSUB
420
380 IF I=1 THEN 450
390 PRINT" NOW BRING IN YOUR VIP
AND LET HIM/HER TAKE THE TEST.
DON'T TELL THEM ANY OF YOUR
ANSWERS SO THAT THE RESULTS WILL
BE ACCURATE":PRINT:PRINT"
PRESS ANY KEY TO BEGIN..."
400 IF INKEY$="" THEN 400
410 NEXT I
420 INPUT">>ANSWER";AN$(I,QN)
430 AN$(I,QN)=RIGHT$(AN$(I,QN),1
)
440 IF VAL(AN$(I,QN))<1 OR VAL(A
N$(I,QN))>NA THEN 420 ELSE CLS:R

```

```

ETURN
450 PRINT" THAT COMPLETES THE TE
ST. I AM NOW TESTING THE RESULT
S...."
460 FOR I=1 TO 25
470 IF AN$(0,I)=AN$(1,I) THEN PT
=PT+4
480 NEXT I
490 IF PT<50 THEN PRINT:PRINT" S
ORRY, YOU TWO JUST DON'T SEEM TO
BE COMPATIBLE.":PRINT" ON THE O
THER HAND, PEOPLE WHO SEEM INCO
MPATIBLE HAVE BEEN KNOWN TO
LAST A LIFETIME TOGETHER.
DON'T YOU KNOW SOME OF THEM?":GO
TO 530
500 IF PT>=50 AND PT<=70 THEN PR
INT:PRINT"IF YOU'RE YOUNG OR ESP
ECIALLY FLEXIBLE, YOU MIGHT MA
KE IT TOGETHER.":GOTO 530
510 IF PT>=70 AND PT<90 THENPRIN
T:PRINT"WITH A FEW COMPROMISES,
YOU SHOULD HAVE A VIABLE PAR
NERSHIP.":GOTO 530
520 IF PT>=90 THEN PRINT:PRINT"A
MATCHMAKER'S DREAM."
530 PRINT" OUT OF A POSSIBLE 100
, YOU TWO SCORED";PT
550 END

```

**STAT'S \*\*EXPANDED\*\***  
A STATISTICAL ANALYSIS PROGRAM, THAT CALCULATES-MEAN,--VARIANCE  
AND STANDARD DEVIATION FOR BOTH SAMPLES OR POPULATION  
PERMUTATION AND COMBINATIONS, Z and T TESTS, CURVE FITTING,  
(LINEAR, EXP., LOG., POWER,) EASY MODIFICATION OF STORED DATA,  
COMBINE TWO FILES, ETC. USER FRIENDLY!  
CASSETTE \$24, 95  
OR DISK \*

**COLOR GRAPHIC PRINTER UTILITIES**  
UTILITIES FOR RADIO SHACKS CGP-115,COLOR GRAPHIC PRINTER/PLOTTER  
WORD PROCESSOR--SUPPORTS EMBEDDED CONTROLS FOR PRINT SIZE OR COLOR  
RIGHT JUSTIFICATION, DESIGNED JUST FOR THE CGP-115  
SCREEN PRINT PROGRAM---TRUE FOUR COLOR PRINT OUT, WORKS IN MODE 3  
OR 4 YOU WON'T BELIEVE THE DETAILS  
DRAWING BOARD---ETCH-A-SKETCH FOR THE PRINTER, ANY COLOR, EASY  
CORRECTIONS  
CASSETTE \$24, 95  
OR DISK \*  
REQ. EXT BASIC.

**RELOCATE**  
RELOCATE MAKES AUTOMATIC TAPE COPIES OF ANY COLOR COMPUTER  
CARTRIDGE. ALLOWS CHANGES TO BE MADE TO THE PROGRAM SUCH AS  
(PRINT-OUT AUDEOTEX, CHANGE BAUD RATE IN \*SCRIPTSIT, ETC.)  
REQUIRES EITHER A 64K MOD. OR A 16K OR LARGER COMPUTER WITH A  
CARTRIDGE MEMORY EXPANSION OF 4K OR LARGER, VERY EASY TO USE!  
ONCE FAMILIAR WITH THE PROGRAM, COPIES CAN BE MADE IN LESS THEN  
FOUR MINUTES  
CASSETTE \$24, 95

**COMPUTERIZED ALARM SYSTEMS**  
LET C&C WATCH YOUR HOUSE WHILE YOU ARE AWAY. LESS THAN TWENTY  
DOLLARS OF RADIO SHACK COMPONENTS. PLANS AND SOFTWARE.  
WRITE FOR DETAILS

(THIS AD TYPESET WITH THE COLOR GRAPHIC PRINTER)

**TRANSITION TECHNOLOGY** PLEASE SPECIFY  
P.O. BOX 1332 SYSTEM  
HIGHLAND PARK, IL 60035 16K-PIN  
SHIPPING AND HANDLING \$1.50 C.O.D. EXTRA  
\* AVAILABLE ON DISK ADD \$2.00 STANBY Corp

# Inputting Your Role Playing Characters

By Bob Albrecht  
and  
George Fire Drake

Last time we showed you two simple programs called *KEYBOARD-MEMORY-TAPE* and *TAPE-MEMORY-SCREEN*. Next, let's write a program to put information about role playing characters on a cassette tape. When you run our program, the CoCo asks for the name of your character and the values of the seven basic characteristics. Here is what happened when we entered Aloysious's characteristics.

```
CHARACTERS TO TAPE
NAME OF CHARACTER? ALOYSIOUS
STR? 10
CON? 11
SIZ? 10
INT? 12
POW? 10
DEX? 12
CHA? 9
OK TO PUT ON TAPE (Y OR N)?
```



After the CoCo finished putting the information in the tape buffer the screen looked like this:

```
CHARACTERS TO TAPE
NAME? ALOYSIOUS
STR? 10
CON? 11
SIZ? 10
INT? 12
POW? 10
DEX? 12
CHA? 9
OK TO PUT ON TAPE (Y OR N)?
ABOVE RECORD IS IN TAPE BUFFER
TO ENTER A RECORD, PRESS SPACE
TO CLOSE FILE, PRESS 'C'
```

When the CoCo asks OK TO PUT ON TAPE(Y OR N)?, you might type N for no. In this event, you will see the following.

*(Bob Albrecht and George Fire Drake are two of the most prolific authors in the microcomputer world today. Specialists in writing for beginners, they are authors of numerous books, including TRS-80 Color BASIC.)*

## CHARACTERS TO TAPE

NAME? ■

Here is the first part of the program.

```
1000 REM**CHARACTER RECORDS
1010 OPEN "0", -1, "CHARACTERS"
1020 CLS
1030 PRINT "CHARACTERS TO TAPE"
```

Line 1010 tells the CoCo to open a cassette file for output. The file is called *CHARACTERS*.

```
1010 OPEN "0", -1, "CHARACTERS"
```

Open for output  
to cassette  
a file named

Line 1010 is written for Extended Color BASIC. If you are using Color BASIC, write line 1010 as follows:

```
1010 OPEN "0", #-1, "CHARACTERS"
```

Put a # sign here.

Next, let's get the information to put on tape, the name of the character and the seven basic characteristics.

```
1100 REM**GET CHARACTER INFO
1110 PRINT: INPUT "NAME": NAYM$
1120 PRINT
1130 INPUT "STR": STR
1140 INPUT "CON": CON
1150 INPUT "SIZ": SIZ
1160 INPUT "INT": INQ
1170 INPUT "POW": POW
1180 INPUT "DEX": DEX
1190 INPUT "CHA": CHA
```

After someone has entered the information about a character, the CoCo wants to know if it is okay to put this information into the cassette file.

```
1200 REM**OK TO PUT ON TAPE?
1210 PRINT
1220 PRINT "OK TO PUT ON TAPE (Y
OR N)?"
1230 K$=INKEY$: IF K$="" THEN 1230
1240 IF K$="Y" THEN 1310
1250 IF K$="N" THEN 1020 ELSE 12
30
```

If someone typed Y for yes, the CoCo writes the character's name and seven basic characteristics into the tape buffer.

```
1300 REM**PUT RECORD ON TAPE
1310 PRINT #-1, NAYM$, STR, CON, SI
Z, INQ, POW, DEX, CHA
1320 PRINT @416, "RECORD IS IN T
APE BUFFER"
```

Now you get to choose whether to enter another character record or to close the file.

```
1400 REM**WHAT TO DO NEXT
```





# Put on your thinking cap for these exciting educational games

## The Great USA



\$19.95 - Tape

- For grade 4 and up
- Sharpen your knowledge of the 50 states
  - Abbreviations
  - Capitals
  - Nicknames
  - Birds
  - Trees
  - Flowers
  - Random combinations of the above
- Play alone or compete against each other
- Ideal for home or classroom
- Colorful, detailed maps
- User modification input
- Both 16K ECB and 32K ECB versions included on the tape
- Easily moved to disk

## GALACTIC HANGMAN

\$17.95



- For grade 2 and up
- Exciting version of popular word guessing game
- Play against the computer or a friend
- Outstanding high-resolution graphics and animation
- Great sound effects and music
- 700 word vocabulary included
- Create your own word files
  - your child's spelling list
  - foreign language vocabulary
  - specialized word list, i.e., geographic, chemistry, physics
- Broaden your vocabulary
- Both 16K ECB and 32K ECB versions included on tape
- Easily moved to disk

## Bible Stories Adventure



\$19.95 - Tape  
\$24.95 - Disk

- Great first adventure for your child
- Familiar Bible Stories
  - Adam and Eve
  - Noah's Ark
  - Abraham and Isaac
  - Moses and the Exodus
  - David and Goliath
- Fantastic high-resolution graphics
- Super sound effects
- Requires 16K ECB



A complete catalog of other sweet Sugar Software products is available.

**SUGAR SOFTWARE**  
2153 Leah Lane  
Reynoldsburg, Ohio 43068  
(614) 861-0565



Add \$1.00 per tape for postage and handling. Ohioans add 5.5% sales tax. COD orders are welcome. CIS orders EMAIL to 70405.1374 Dealer inquiries invited.

# For the serious student . . . . . . . from Preschool to College . . . .

- Ages 3-5
- Hand-eye coordination
- Colors
- Shapes
- Numbers
- Great graphics and music
- Reading readiness skills
- Capital letters
- Small letters
- Learn to associate letters and letter blends with the sounds they make
- Requires 32K ECB and joysticks



## PreReader



**\$19.95 - Tape**  
**\$24.95 - Disk**

## Silly Syntax

**Tape - \$19.95**  
**Disk - \$24.95**  
**Disk with 62 stories - \$49.95**



- Grade 5 and up
- Ideal for classroom and home use
- Increase your vocabulary
- Sharpen your language arts skills
- Improve your reading and creative writing skills
- Can also be used as a party game or family fun
- Includes user guide program and 2 stories
- Requires 16K ECB

### Additional Silly Syntax story tapes available:

10 stories per tape - **\$9.95 per tape**

- SS 001 - Fairy Tales
- SS 002 - Sing Along
- SS 003 - X-Rated
- SS 004 - Current Events
- SS 006 - Adventure/Science Fiction
- SS 007 - Potpourri

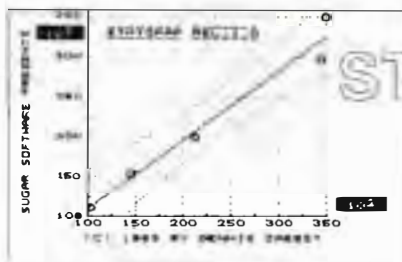

**\$24.95 - Tape**  
**\$29.95 - Disk**

STATGRAF is a linear regression analysis program combined with a powerful but easy to use plotting/line graphing system. Designed for professional, technical, business, and educational use, among its many features are:

- Grade 10 and up
- Type titles and labels on the graph in any of three orientations
- Position titles and labels where they will not interfere with the graph
- Save data and *completed graphs* on disk or tape; display disk directory
- Transform data: logs, square root inverse, exponential, additive codes
- Calculate, display and plot residuals
- Powerful data editor: append, delete, insert, change
- Plot multiple data sets; symbols include 5 figures or *any text character*
- Calculate, display, and print regression statistics and tests of significance
- Superimpose frame, regression line, 95% confidence limits, grid
- Works easily with common machine language screen print programs (not supplied)
- Same program works with either tape or disk
- Requires 32K ECB

A complete catalog of other sweet Sugar Software products is available.

**SUGAR SOFTWARE**  
2153 Leah Lane  
Reynoldsburg, Ohio 43068  
(614) 861-0565



Add \$1.00 per tape for postage and handling. Ohians add 5.5% sales tax. COD orders are welcome. CIS orders EMAIL to 70405.1374. Dealer inquiries invited.



```

1130 INPUT "STR"; STR
1140 INPUT "CON"; CON
1150 INPUT "SIZ"; SIZ
1160 INPUT "INT"; INQ
1170 INPUT "POW"; POW
1180 INPUT "DEX"; DEX
1190 INPUT "CHA"; CHA
1199 *
1200 REM**OK TO PUT ON TAPE?
1210 PRINT
1220 PRINT "OK TO PUT ON TAPE (Y
OR N)?"
1230 K$=INKEY$:IF K$=""THEN 1230
1240 IF K$="Y" THEN 1310
1250 IF K$="N" THEN 1020 ELSE 12
30
1299 *
1300 REM**PUT RECORD ON TAPE
1310 PRINT #-1, NAYM$,STR,CON,SI
Z,INQ,POW,DEX,CHA
1320 PRINT @416, "RECORD IS IN T
APE BUFFER"
1399 *
1400 REM**WHAT TO DO NEXT
1410 PRINT "TO ENTER A RECORD, P
RESS SPACE"
1420 PRINT "TO CLOSE THE FILE, P
RESS 'C'";
1430 K$=INKEY$:IF K$=""THEN 1430
1440 IF K$=" " THEN 1020
1450 IF K$="C" THEN 1510 ELSE 14
30
1499 *
1500 REM**CLOSE THE FILE
1510 CLOSE -1
1520 CLS
1530 PRINT "THE FILE IS CLOSED"
1540 END

```



### Greetings!

I sat out on the front porch the other night, looking at the stars. Then I heard an ominous click — Bertha (may her name be whispered with reverence among the immortals) had locked me out. It was freezing cold out there, but I got to look at all the stars in the sky for a long time. The stars out here in the country are bigger and brighter than city stars, you know. Anyhow, I started thinking about stars, and decided that as soon as I got inside the house I would try a few on my Color Computer. I spent the rest of the night communing with Ben, in confined but cozy quarters. The next morning, I managed to get inside the house, and went downstairs to my computer. I thought about several ways I might try to do stars, and equal-sided, equal-angled triangles.

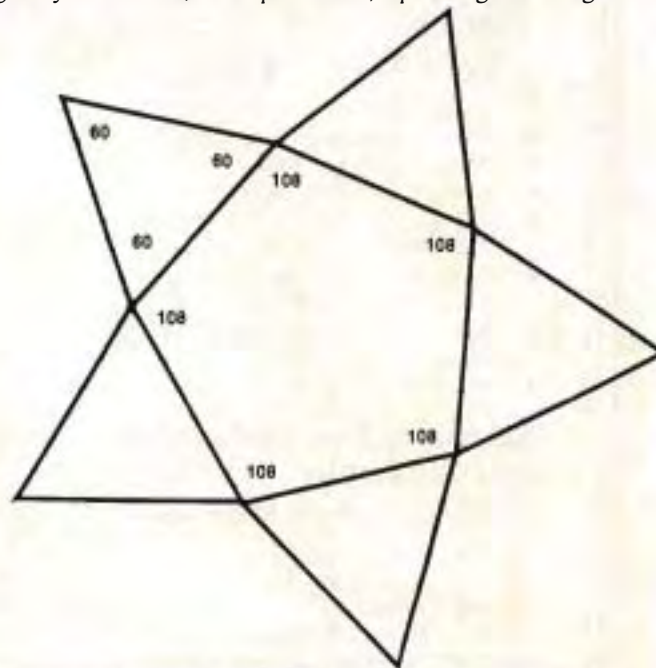

### FANTASY ROLE PLAYING GAMES

Millions of young people, and many not-so-young, are playing fantasy role playing games. A role playing game is a game in which one or more players create and control characters (adventurers) who live their imaginary lives in a specially made game world. The game world is created, managed, and operated by a Game Master (GM), also called a referee, adventure master, or dungeon master (DM).

Most people who play role playing games use a formal rule system. Some of the best known are shown below.

**Champions.** From Hero Games, 92A 21st Avenue, San Mateo, CA 94402.

**Dungeons & Dragons (D&D).** From TSR Hobbies, P.O. Box 756, Lake Geneva, WI 53147.

**RuneQuest (RQ).** From Chaosium, P.O. Box 6302, Albany, CA 94706.

**Tunnels & Trolls (T&T).** From Blade, Box 1467, Scottsdale, AZ 85252.

**Worlds of Wonder (WOW).** From Chaosium, P.O. Box 6302, Albany, CA 94706.

Most programs in "Game Master's Apprentice" are based on the game system used in *RuneQuest*, *Worlds of Wonder*, and *Adventurer's Handbook*. If you are a beginner, we suggest you try the following books.

*Adventurer's Handbook: A Beginner's Guide to Role Playing Games* by Bob Albrecht & Greg Stafford.

*Through Dungeons Deep* by Robert Plamondon.

Both are available from Reston Publishing Company, 11400 Sunset Hills Road, Reston, VA 22090.

Copyright © 1983 by DragonQuest, P.O. Box 310, Menlo Park, CA 94025.

(W. Bert Woofensburger ["Uncle Bert"] manages a hog and corn farm near Ypsilanti, Mich. He has recently acquired a Color Computer and is learning LOGO. Woofensburger's editor and assistant, Dale Peterson, writes for a living. His recent books include "Genesis II: Creation and Recreation With Computers" and "Intelligent Schoolhouse: Readings On Computers and Learning." He is currently working on a book about Color LOGO with Don Inman and Ramon Zamora, to be published in 1984.)

Just to play around and remind myself about the angles involved, I made an equal-sided, equal-angled triangle:

```
TO TRIANGLE
  REPEAT 3 (FD 60 RT 120)
END
```

And I made an equilateral pentagon:

```
TO PENTAGON
  REPEAT 5 (FD 60 RT 72)
END
```

Then I played around with triangles and pentagons that had variable sides:

```
TO TRIANGLE2 :N
  REPEAT 3 (FD :N RT 120)
END
```

```
TO PENTAGON2 :N
  REPEAT 5 (FD :N RT 72)
END
```

Then, I thought about the angles of turtle-turning that would be involved when triangles are stacked around a pentagon, and came up with this star:

```
TO STAR :N
  RT 30
  REPEAT 5
    (FD :N RT 120 FD :N LT 48)
  END
```

And I tried various values for :N, including 10, 20, 35 and 50.

My star was always starting at home position, which was all right, I suppose. But I wanted to try other positions on the screen. Now, in the past when I've wanted to start a drawing at a position other than the home position, I've always just snuck the turtle over by telling it to PENUP (PU), then move over, then PENDOWN (PD). But, I've recently discovered a new way. Apparently, positions on the Color Computer's screen can be described by numbers. There are X numbers, which describe locations widthwise across the screen. Then there are Y numbers, which describe locations up-and-down-wise on the screen. With Color LOGO, you can place the turtle anywhere on the screen by specifying the X and Y locations you want, using the following commands: SETX and SETY. It seems that you can choose your X locations with numbers from 0 to 255, and your Y locations with numbers from 0 to 11. The turtle's "home" is in the middle of all that, at a position where X equals 128 and Y equals 96.

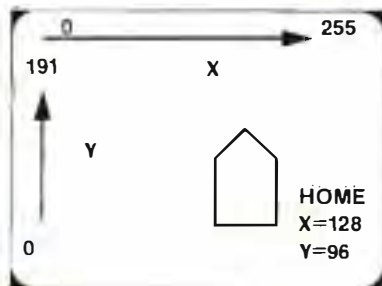

Anyhow, I decided to try a star that was just a little higher than the home position (thus using a SETY that was greater than 96). Did I mention that the abbreviations for SETX and SETY are SX and SY?

```
TO STAR1 :N
  SY 120
  REPEAT 5
    (FD :N RT 120 FD :N LT 48)
  END
```

Then I said to myself, "What the heck — if the number of a side length can be a variable, why can't my X and Y values?" So I tried that.

```
TO STAR2 :N :X :Y
  PC 1
  SETX :X SETY :Y
  REPEAT 5
    (FD :N RT 120 FD :N LT 48)
  END
```

Next, I tried my usual fancy-dancy variations.

```
TO STARSTAR :N
  SY 120
  REPEAT 5
    (PC 1 FD :N RT 120
     PC 2 FD :N LT 48)
  END
```

```
TO STARSTAR2 :N
  REPEAT 50 (STARSTAR :N RT 1)
  END
```

I didn't really like STARSTAR2:N very much. I had been hoping for a kind of star-circling effect, something neat and symmetrical. I thought about what was happening and realized the trouble was that my star was always beginning at a "valley" on the star's edge, and that beginning position was making everything mush up. So I decided to start my star from a tip and then try to spin it around. Thus, I did this:

```
TO STAR3 :N
  FD :N
  REPEAT 4
    (LT 48 FD :N RT 120 FD :N)
  LT 48 FD :N RT 120
  END
```

```
TO STARCIRCLE :N
  REPEAT 20
    (PC 1 STAR3 :N RT 18)
  END
```

I picked the number 20 at random, thinking that would look nice. The RT 18 arose because I wanted the repeating star to fill a whole circle (18 times 20 brings us all the way around to 360). Thinking about that I realized I might make effective use of a second variable for the number of times the pattern repeated.

```
TO STARCIRCLE2 :N :T
  REPEAT :T
    (PC 1 STAR3 :N RT 360/:T)
  END
```

I decided to get fancier:

```
TO STARCIRCLE3 :N :T
  REPEAT :T/2
    (PC 1 STAR3 :N RT 360/:T
     PC 2 STAR3 :N RT 360/:T)
  END
```

And fancier:

```
TO STARCIRCLE4 :N :T
```

```
MAKE :M :N/2
STARCIRCLE3 :N :T
REPEAT 3 (PC 0 STAR3 :M RT 120)
END
```

Next, I thought it might be nice to build a star that would fill itself in. One possible way to do it might be to run the star outline procedure (TO STAR3 :N), and keep reducing the value of :N. How do we reduce the value of :N? We could run STAR3 several times, and each time specify the value of :N by typing it out. But that means too much typing for Uncle Bert. Fortunately, there is an easier way, and it has to do with the MAKE statement. The MAKE statement allows us to include variables internally within a procedure, and change them automatically, as part of the procedure. Not clear? Let's try it:

```
TO STARFILL
MAKE :N 25
REPEAT 25 (STAR3 :N
RT 30 FD 1 LT 30
MAKE :N :N-1
END
```

Neat, huh? I like the way the size of :N diminishes automatically in the procedure. For various reasons beyond our control, that did not completely fill the star. So, we'll keep that procedure and then sneak along the edge of the star and do it again from one of the other tips. Like so:

```
TO STARFILL2
STARFILL
HOME
REPEAT 3
(FD 25 LT 48 FD 25 RT 120)
STARFILL
END
```

Not perfect, but good enough for me. No, I'll give the whole thing a better color, and tilt it:

```
TO STARFILL3
RT 5 PC 1
STARFILL
HOME RT 5 PC 1
REPEAT 3
(FD 25 LT 48 FD 25 RT 120)
STARFILL
END
```

Notice that I have to specify pencolor after HOME. The HOME seems to cancel previous conditions, including pencolor. No, to make my filled star really mobile, I ought to introduce variables for position. Like so:

```
TO STARFILL4 :X :Y
SX :X SY :Y
RT 5 PC 2
STARFILL
SH 0 SX :X SY :Y
RT 5
REPEAT 3
(FD 25 LT 48 FD 25 RT 120)
STARFILL
END
```

I put in the SH 0 (SET HEADING 0) just to make sure my turtle was pointing straight up before I went into the rest of the procedure. Try that one, with various values for :X and :Y. All right — enough pussyfooting on little cat feet, as the poet says! So, try this:

```
TO FIELD
HT PC 1
MAKE :Y 191
REPEAT 88 (SX 0 SY :Y)
RT 90 FD 100 LT 90
MAKE :Y :Y-1)
END
```

```
TO STARINFIELD
FIELD
MAKE :X 28 MAKE :Y 114
STARFILL4 :X :Y
END
```

That gives a red star in a blue field. To avoid serious misunderstandings at the international level, go back to the STARFILL4 :X :Y procedure, and change the pencolor to 3. You may also want to experiment with the PCs in FIELD and in STRIPE and STRIPE2, and with COLORSET, to get the proper and patriotic blue and red. Now:

```
TO STRIPE
SH 0
MAKE :Y 191
REPEAT 2 (PC 2 REPEAT 22
(SX 101 SY :Y
RT 90 FD 154 LT 90
MAKE :Y :Y-1)
PC 3 REPEAT 22
(SX 101 SY :Y
RT 90 FD 154 LT 90
MAKE :Y :Y-1))
END
```

```
TO STRIPE2
MAKE :Y 103
REPEAT 2 (PC 2 REPEAT 22
(SX 0 SY :Y
RT 90 FD 255 LT 90
MAKE :Y :Y-1)
PC 3 REPEAT 22
(SX 0 SY :Y
RT 90 FD 255 LT 90
MAKE :Y :Y-1))
END
```

```
TO STARNSTRIPES
STARINFIELD
STRIPE
STRIPE2
END
```

All we need is music! I remain,

— Uncle Bert

P.S. You can send your cards and letters to me in care of my good friend Dale Peterson. Just address them like this:

Uncle Bert Woofensburger  
c/o Dale Peterson  
*the Rainbow*  
9529 U.S. Highway 42  
P.O. Box 209  
Prospect, KY 40059

© copyright 1983,  
By W. Bert Woofensburger  
and  
Dale Peterson

# WATERLOO



## KAMIKAZE



## BOMBER COMMAND



## Across The Rubicon

# WE CHALLENGE YOU!

ARK ROYAL provides three types of game: The Strategy Wargame, Strategy Arcade and Arcade games.

**ACROSS THE RUBICON** 16K EXT or NON EXT — The popular WWII wargame. Break thru the Huertgen Forrest using infantry, tanks, paratroops, air and artillery strikes and destroy Hitler's plans for the Battle of the Bulge, CASSETTE ...\$19.95.

**ACROSS THE RUBICON** 32K (formerly Rubicon II) EXT The wargamer's choice! Everything ATR has and mortar units, patrols, German artillery, platoon movement, supply, intelligence, spotting rounds, unit merge, game save and much more! CASSETTE... \$24.95.

**WATERLOO!** 32K — Player tries to do what Napoleon couldn't: defeat Wellington and move into Waterloo. French forces include cavalry, artillery, guards, infantry and squirmishers. CASSETTE \$24.95.

**MISSION EMPIRE** 32K EXT cass or disk. Starting with one planet, incomplete intelligence and limited resources, you must form alliances, build armies and conquer the galaxy. Game save. Cass or Disk version on Cassette...\$24.95.

**BOMBER COMMAND** 16K EXT The air war over Germany, 1941-45. Player must destroy German industry while fighting off flak, the Luftwaffe and bad navigation. CASSETTE... \$22.95.

**STARBLAZER** 32K EXT During your absence, the SPECTRUM galaxy has been overrun by the draconic xyclons. Now you command the only Starship left to retaliate. CASSETTE...\$24.95.

**GALACTIC TAIWAN** 32K EXT Battle storms, pirates and high taxes In hopes of making a profit in the galaxy. CASSETTE...\$24.95.

**KAMIKAZE** 32K — Based on historical reports of the savage Kamikaze attacks at the end of WWII. Hi-res graphics include search, radar, air vs air, air vs ship, and the Kamikaze attack. Player may use joysticks or not. CASSETTE...\$24.95.

**LASER SUBS** 16K (Suited for kids, 12 and under). Hi-res graphics. Lots of fun — kids love it! Your destroyer discovers a fleet of enemy's laser-firing subs heading towards the surface. Destroy them with depth charges before they blast you apart. Joysticks CASSETTE...\$15.95.

**CRYSLON** — 32K 3-D graphics, joysticks. Player commands the remote-controlled defense missiles of the planet Cryslon. Your mission — defend the planet's cities from invading aliens with powerful lasers. CASSETTE...\$19.95.

P-COPY 32K disk only. \$19.95. Arrange or rearrange a single disk or four at a time with this menu-fed program. Copy, backup, kill, direct, rename, print, read or whatever you need to do with disk files. Uses single key commands. A must for the disk owner who wants to organize.

ROMPAC BACKUP 64K \$15.95. Cassette only. Can't run your rompacs with your disk in or just want backup? Rompac Backup makes it easy.

ALL GAMES ARE GRAPHICALLY PORTRAYED. None are word games. We guarantee that if you've ever dreamed of commanding an army then what we offer will please you.

Orders are shipped the day they are received regardless of check or money order. Send no cash, please. We pay shipping on all prepaid orders. On C.O.D.'s, customer pays charges. No bankcard sales. We have enough paperwork already.

All games strategy oriented, graphically portrayed and guaranteed from defect and boredom. For DISK version add \$3.00. No mail delays with personal checks. State system with order.

DEALER DISCOUNT AND COLOR DISPLAY PACKAGING AVAILABLE.

WE CARRY UTILITY SOFTWARE, TOO!

All Programs require Color ComPuter™ (Tandy Corp) or TDP System 100 ComPuter™ (RCA)



**P. O. Box 14806  
Jacksonville, FL 32238  
904 777-1543**

Prices on All games include shipping. Florida Resident add 5% tax.

It seemed like every time I was turning around last month someone in the office was handing me an airplane ticket for someplace. The highlight of the month was a trip to Las Vegas for the COMDEX show. It was somewhat disappointing in that there were so many "new" computers on display — with, to my mind, no chance that they will all survive in the marketplace in the coming year.

But the biggest news of the show — or the most-talked-about product — was the new IBM PCjr. computer. Frankly, it was a disappointment for me. My feeling is that it is priced too high, does not have the gloss of the IBM PC, and may have rushed ahead to get into an under-\$1,000 market. It barely makes it into that category and I, for one, think it will be a real test of whether the American public will buy a computer for the capabilities or the "name."

I also took a few days to attend the World of Commodore show in Toronto, and was pleased to see several of our Canadian friends who were, as I was, checking out another market.

What impressed me most about the show was the attempt by Commodore to absolutely dominate their computer's market. Radio Shack has always had a bad rap — usually from one source which will go hercin unnamed — for being "closed" to the third party market. If anyone wants to pin that rap on Radio Shack today, they should look at Commodore.

Come to a **RAINBOWfest** and you will see a variety of printers, modems, disk drives and the like. Certainly, Radio Shack equipment seems to predominate — but part of that reason, I firmly believe, is because firms which manufacture disk drives and printers do not actively market to the CoCo (see, for example, the number of such manufacturers who *directly* advertise on these pages).

Yet, in Toronto, what I saw were Commodore disk drives, Commodore printers, Commodore monitors. Heck, there were even two Commodore company magazines. And the magazines do not accept advertisements from third parties.

What I am saying is that Commodore really tries to dominate its market. And, I believe, one of the reasons CoCo has been so successful is because of the participation of third party vendors in the market. My opinion is that this is a forward-looking approach on Tandy's part and that they don't deserve the bum rap that some people try to pin on them.

By the way, I think, too, that the dominance of Commodore in its own market very badly hurts what some call "kitchen table software" firms. If you have to compete directly with the people who make the computer, you have to have a certain "bigness" about you. I know lots of people who started up in the CoCo market on a shoestring (*the Rainbow* included) and I still believe the Color Computer offers an opportunity for good old incentive, no matter how small you may be.

It would be unfair for me to mention the Commodore show without mentioning the warm-hearted people of that fine city. In three days north of the border, I did not encounter a single person who was not a first-class representative of a wonderful country. From the guard at customs to the taxi drivers (who I *think* I convinced to buy a CoCo), everyone I met or spoke to was warm, friendly, helpful and, as we say here in the south, "good folks."

You have no doubt read things I have to say about Radio Shack from time to time that have been very positive. Well, I suppose you should know that those are not just words.

From the beginning, we have used Radio Shack equipment in the business end of *the Rainbow* as well as the publication end. We do that because we have a very good feeling for the reliability of the equipment and, too, because we don't feel we have to be programmers to make it work. We use Color Computers for a variety of things besides just publication of *the Rainbow* and its sister computer magazine, *PCM — The Portable Computing Magazine*.

As an example, we are able to use Color Computers to typeset copy for the magazines through our typesetting equipment and, in the case of another publication, *SCORECARD*, a sports weekly, we use Portable Computers to do statistics and write game stories.

We have a Radio Shack telephone system which works very well and we have historically used Model 11s, 12s and 16s for our subscription service, general accounting and the like.

Just this past month we took another step, and began conversion to a multi-user environment for subscription service on the new Xenix software from Radio Shack. One of the prime reasons for that decision was the ease of converting our present subscription data files from single-user Model 16 to Xenix. It means faster answers to your subscription queries, for one thing. And it also means that now we can have more than one person entering new subscriptions (or updating renewals) at a time. We've been growing very rapidly, and the need for this single feature has become a must. By the way, if your subscription label last month was a little bit different (perhaps no expiration date) blame it on the dummy (me) who forgot to put it on. It is fixed now.

I guess what I am saying is that you often read here about how good I think this or that at Radio Shack is. We don't just say it at *the Rainbow*, we believe it and practice that same philosophy.

— Lonnie Falk

# L\*BERTO

A 3-D CUBE GAME

for TRS Color Computers

TDP - System 100 & Dragon - 32

**TAPE \$27.95 • DISK \$30.95**



SEND CHECK OR MONEY ORDER TO:

**Phoenix Enterprises**

P. O. Box 76

Oak Forest, Illinois 60452

BY GUYASTAGL & HANDELSON  
Dist. in Resale Only, Excludes C.C. Sales Tax



# A RUSSIAN SPY MISSION

for  
SR-71



*Air Speed • Fuel Gauge • Rate of Climb and Descent • Radar • Artificial Horizon • True Time Clock*  
So real - you will feel as if you are in the cockpit on a real spy mission. Elude Russian missiles as well as their detection devices. Another Tom Mix exclusive. A must for the adventurous. Fantastic Graphics, color and sound.

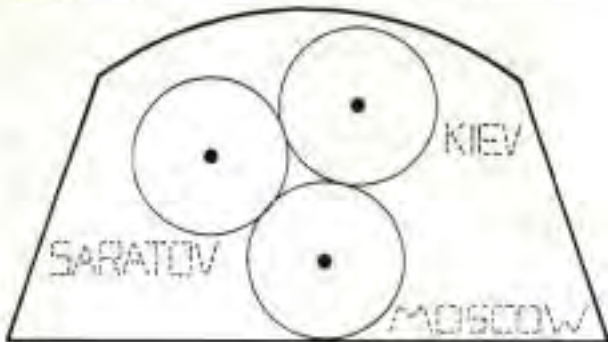

**Missile Zones**



**Expanded Map View**

SR-71 is a fast action game in which you are the pilot on a mission to take photographs of missile sites in Russia and deliver them to our processing laboratory in Japan.

**TAPE \$28.95**

**32K EXTENDED BASIC**

**DISK \$31.95**

# M

## TOM MIX SOFTWARE

TELEX  
706139

•FOR THE COLOR COMPUTER & TDP 100 • 3424 College N.E., Grand Rapids, MI 49505 (616) 364-4791 •

Call direct 616-364-4791 or 24 hr. BBS 616-364-8217

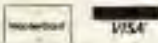

## A Teeny *Tinydump*

By Dave Anthony

Here is a 2-line program which will dump *PMODE* 0, 2 and 4 graphics to a DMP-100 printer. I wrote this program when I was unable to find one elsewhere that would print one dot per screen point. The program gives a small picture, which helps to overcome CoCo's low pixel resolution, hence, the name *Tinydump*.

Being in BASIC, it can take a good deal of time to print one screen. However, it is simple and relatively easy for an intermediate CoCo programmer to understand.

Since a hi-speed poke is used, CoCo should be set to output at 600 Baud, which will effectively be 1200 Baud. The printer should be at 1200 Baud.

*Tinydump* is a poor person's screen dump, requiring Extended BASIC and the least expensive printer Radio Shack makes.

Here is an example of *Tinydump*:

DRINKING PREFERENCES IN EUROPE --

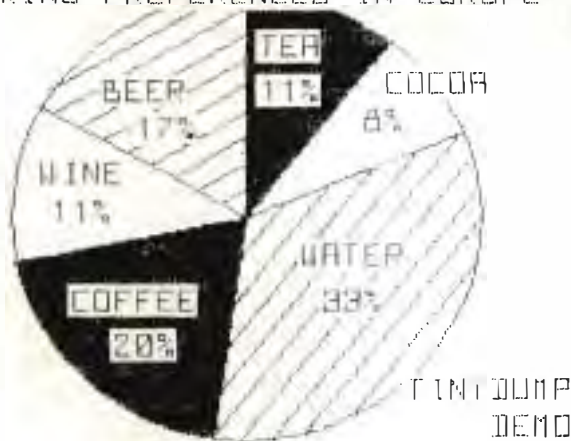

The listing:

```
10 SCREEN1,0:POKE65495,0:FOR Y=11
04:PRINT#-2,CHR$(18):NEXT Y:FOR Y=
0T0191STEP7:PRINT#-2,CHR$(27);CH
R$(16);CHR$(0);CHR$(112);:FOR X=0
T0255:G=128:FOR C=0T06:IFY+C<192A
NDPPOINT(X,Y+C)THENG=G+2^C
20 NEXT C:PRINT#-2,CHR$(G);:NEXT X
:PRINT#-2,CHR$(13);:NEXT Y:PRINT#
-2,CHR$(30)
```

David C. Owen tells us that we made an error in illustrating his article, "Build An RS-232 Device Select Switch For Under \$20" (December 1983). On page 204, the template in the upper right corner shows locations for holes to be drilled. These are not properly centered. All markings should be made along a horizontal center line, which would raise them a bit from where they are shown in the illustration.

In Richard S. Ellis' article, "Install Your Own Disk Drive 'On/Off' Indicator" (November 1983), instruction number three was inadvertently omitted. It should read:

3) Refer again to the attached picture and find the 0V strip [ground]. Solder a black wire (prestripped on both ends) at the point indicated. You will find another hole in the board here.

A clarification rather than a correction needs to be made concerning Joseph Kolar's article, "Flaunt Your CoCo With Season's Greetings Cards" (December 1983). While this novel program performs as indicated, you need to have a printer with a "bit-image" graphics capability and a screen print program that matches your printer in order to get printed copies of the cards. Good luck with St. Valentine's Day!

Hint . . .

## Format Your Printouts With This Disk Utility

Ted Cizadlo Selig, of Omaha, Neb., writes that this is "a utility I developed to generate a 32-column *LLIST* of a program. I find this helpful in locating typing errors in listings from *the Rainbow*. The program must have an ASCII file ready and will generate an *LLIST* of the program with your specified line width."

Thanks, Ted! Now, how about one for people who don't have disk drives.

The listing:

```
5 CLEAR500:CLS:INPUT"NUMBER OF C
HARS/LINE";CL
10 INPUT"FILE NAME WITH EXTENTIO
N(MUST BE IN ASCII FORMAT)";N$
20 C=0:F=1
30 OPEN"I",#1,N$
50 LINEINPUT #1,A$
60 IF EOF(1)=-1THEN F=0
70 X=LEN(A$)
75 IF X<=CL THEN 150 ELSE IF X=0
THEN 50
90 N=1
100 FOR J=1 TO INT(X/CL+1)
110 PRINT#-2,MID$(A$,N,CL):C=C+1
120 N=N+CL
130 NEXT J
140 IF F THEN 50 ELSE CLOSE#1:EN
D
150 PRINT#-2,A$:C=C+1:IF F THEN
160 ELSE CLOSE#1:END
160 GOTO 50
170 CLOSE#1:END
```

# RAINBOW TECH

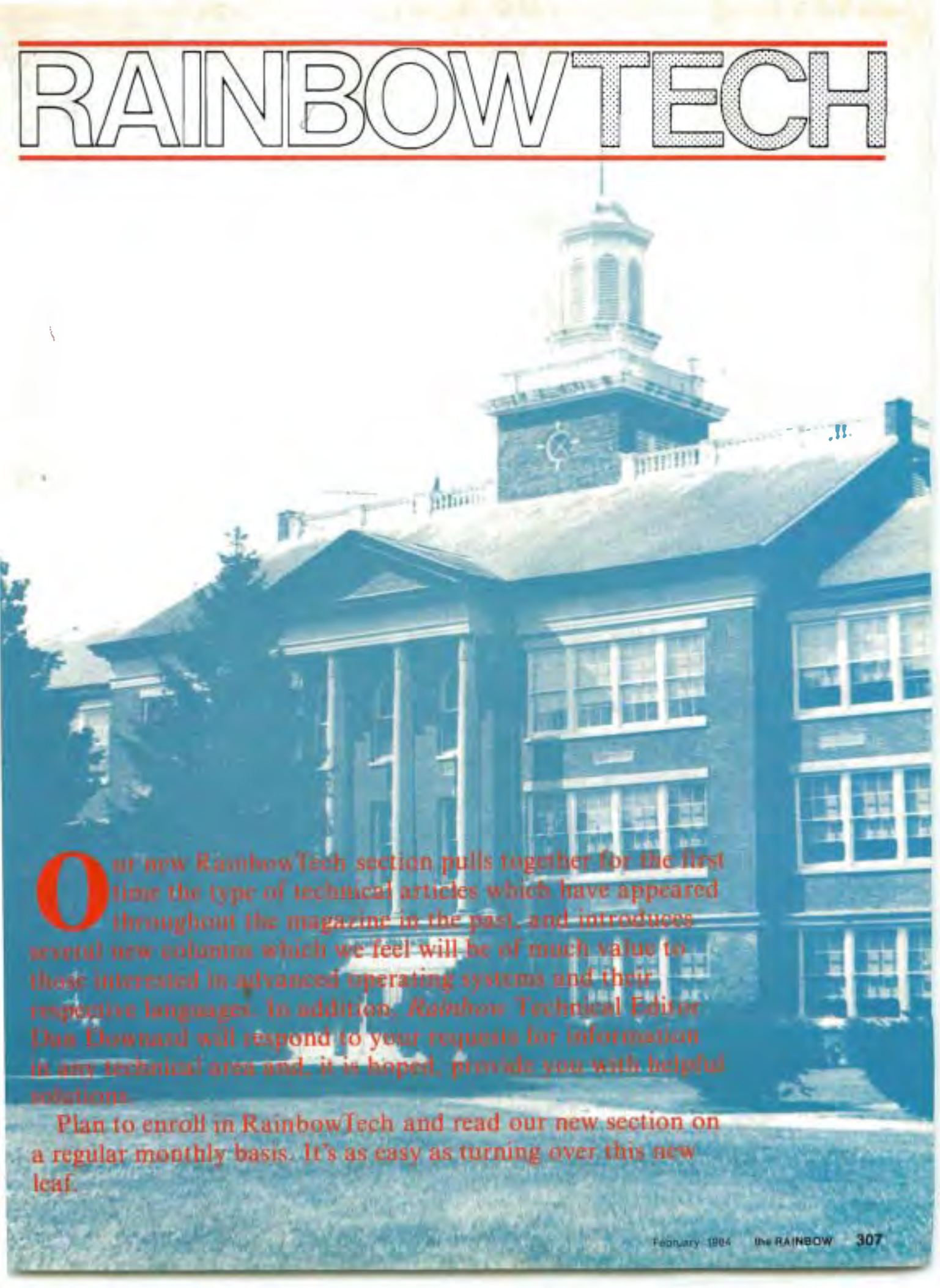

**O**ur new RainbowTech section pulls together for the first time the type of technical articles which have appeared throughout the magazine in the past, and introduces several new columns which we feel will be of much value to those interested in advanced operating systems and their respective languages. In addition, Rainbow Technical Editor Dan Downard will respond to your requests for information in any technical area and, it is hoped, provide you with helpful solutions.

Plan to enroll in RainbowTech and read our new section on a regular monthly basis. It's as easy as turning over this new leaf.

By Dan Downard  
Rainbow Technical Editor

# There Are Many Features To Consider When Purchasing Disk Drives

**W**ould you please have someone run a comparative review on disk drives available to the CoCo?

Steve Hewitt  
Leeton, MO

The choice of disk drives is a toss-up for the CoCo, Steve. Without getting into specific brand names we can give you some things to look for:

Two characteristics, which are very important for drive selection, are the number of tracks and the track-to-track access time. The standard Radio Shack drive is capable of 37 tracks (even though only 35 are normally used) and has a track-to-track access time of 30 milli-seconds. Sounds pretty fast, doesn't it? Disk Extended BASIC assumes you are using this type of drive and the software is based on these values. As the software is in ROM, it cannot be changed.

Other disk drives on the market are capable of 40, and even 80 tracks, and have access times of as low as 6 milli-seconds. These drives will work with Disk BASIC. You can only use 35 tracks and 30 milli-second access

though due to Disk BASIC.

Then there are DOSes (Disk Operating Systems) for the CoCo. The three most common are FLEX, STAR-DOS and OS-9. These DOSes allow a variable number of tracks and different track-to-track access times. When using a true DOS on the CoCo disk, access frequency is far greater. As each program is loaded only when necessary, it becomes important to have fast disk access times. Obviously, the number of tracks is proportional to the storage capacity of the disk. The more the merrier. From a storage capacity standpoint you are far better off with 40 tracks.

There are other considerations too, such as price. Beware of the bare drives advertised in some trade publications. That is exactly what you get: No power supply, no case, or no controller. When you buy a Radio Shack Drive 0, all you have to do is plug it in and you're in business. Other drives will require a controller and cable.

Taking all of the above into consideration, I would recommend that the average user buy a Radio Shack drive. If you are confident you can handle the interfacing, there are other drives on the market that are faster and have more storage capacity. Keep in mind that to utilize these features you have to be running a DOS. We understand that one company now makes a controller that is compatible with Disk BASIC and allows you to reconfigure your disk drive

without a DOS, but this controller has not been reviewed. Good luck.

---

### CoCo Amnesia

• Using the instructions in the June 1983 edition of Rainbow, I extended my 16K "285" ECB. I put 64K chips in it. Now, when I "MEM" I get 24871. A POKE 25,6:NEW will raise the memory to 31015, but that's it. Is there a modification I must make to my 285 board to get the memory up closer to 64K? Or, what do I have to type in to get it?

Ron Hestand  
Radcliff, KY

There is nothing wrong with your computer, Ron. You already have 64K of RAM, but you have to know how to use it. There are two things you must understand, the difference between RAM and ROM, and the memory map of your CoCo.

Even if you have 64K chips installed, when you turn on your computer it is initialized such that the lower 32K, or \$0000-\$7FFF, is configured as RAM and the top 32K, or \$8000-\$FFFF, is configured as ROM. Since Extended BASIC does a PCLEAR-4 and CLEAR200 on startup, you have 24871 bytes left for BASIC programs. This is normal. The POKE 25,6 statement you refer to is actually a PCLEAR0 and gives you 6K of additional memory, if you don't require memory for graphics.

---

(Dan Downard is an electrical engineer and has been involved in electronics for 24 years through ham radio [K4KWT]. His interest in computers began about five years ago and he has built several 68XX systems.)

How do I use the upper part of the 64K RAMs? There are several schemes of using some of this memory. One particularly popular way is to move BASIC from ROM to RAM, and then relocate BASIC. With this method, programs of up to 40K are possible. If you want to try this see Jorge Mir's article "Using The Upper RAM of Your 64K" in October's *Rainbow*. Using the upper 64K of memory is not automatic and requires some imagination. Some other common uses for this "unused" memory are high resolution screens, data storage and printer spooling.

### Use Your Chips Wisely

• I have a TP-10 printer but can't get it to work properly. It isn't the printer, it works fine on another Color Computer. It isn't my RS232 port. I ran the Radio Shack Diagnostic ROM Pack RS232 test and it tested okay. The only other thing I could think of was that I upgraded my D board from its original 4K to its present 32K by piggybacking the RAM chips.

My mind flashed back to a letter to the editor in the October issue of *Rainbow*. His problem was with "color script." You said that piggybacking RAM chips produces "memory overlay" that produces havoc with certain software. Could this "memory overlay" be the problem with my printer also? If so maybe someone knows of a poke that would solve the problem.

Joe Hadley  
Ft. Ord, CA

Joe, when you piggyback a set of 16K chips, pin 4 of the top set of chips is connected to pin 35 of the SAM chip. Pin 4 of the 4116-16K Dynamic RAM is the RAS line, or the row address strobe. Pin 35 of the SAM chip is MA7, or in the case of piggyback RAMs, RAS1.

What all of this means is that your addresses are not absolutely decoded and each byte appears twice in the memory map. Addresses \$0000-\$7FFF correspond to addresses \$8000-\$FFFF, what we normally call a memory overlay. For example, if you would examine address \$0400 with a monitor, the byte value would correspond to the value at \$8400.

Software associated with the printer routine polls the SAM and consequently the PIA chips for a printer busy signal at address \$FF22, Bit 0. Since you have both RAM and the PIA chip at this address, a problem is created.

Our advice is to upgrade to 64K using 4164 chips. In addition to solving your problem, your computer will run cooler and you can make use of 64K software offering many new advantages.

### A Talking Gorilla?

• I am writing in reference to Tony DiStefano's article on Page 230 in the November '83 issue. I have a Gorilla monitor and as you are aware, it doesn't have an audio output. The article shows how to hardwire a speaker and amp inside the computer, but I wanted to know if there was some device to be con-

nected outside the computer, possibly using the present jack.

Scott Nelson  
Atlanta, GA

Scott, the same circuit you are referring to in the November *Rainbow* could be installed in your monitor just as well as inside your computer. The only problem may be locating a source of 12 Volts DC.

Any audio amplifier will work with the CoCo. Just pick up the audio input from the point listed in the article. If you have trouble finding a source of voltage, try using a battery.

### Same Language, Wrong Dialect

• When I bought my TRS-80 CoCo from a local Radio Shack Computer Center, the salesman told me that I could purchase an adapter so I would be able to use different cartridges with this CoCo. But, he never has been able to find this information. Is there, in fact, such an accessory for my CoCo? Can I purchase an adapter so my TRS-80 can use software designed for Atari or any other computer system?

Raymond Patrick  
Niagara Falls, NY

I think you received some bad information, Ray. I assume you are referring to Atari cartridges. Since Atari uses a different microprocessor, the machine codes are not compatible. At the same time, I think just about every game written for the Atari is available for the CoCo. Just read the ads carefully.

### A Dislocated Disk

• Several of my machine language programs load at HEX 600. Disk BASIC also occupies some space at the same address. While I can get a disk copy by loading with an offset and then saving, the programs are apparently position dependent and cannot be relocated. The question then is — can that portion of Disk BASIC, which loads at HEX 600, be relocated elsewhere in RAM without crashing my system?

Gary Leventhal  
Latham, NY

Gary, the area above \$0600 in Disk BASIC is reserved for disk buffers, the area of memory that is used to transfer information from disk to RAM. As far as we know, there is no way to relocate this area.

To solve your problem, you might try appending a short relocater program to the end of your game so that after it is loaded into its offset address from the disk, you move it back to its original location.

Your technical questions are welcomed. Please address them to: Downloads, the *Rainbow*, P.O. Box 209, Prospect, KY 40059. We reserve the right to publish only questions of general interest and to edit for space and clarity.



## NEW PRODUCT

### THE INTRONICS EPROM PROGRAMMER NEWLY DESIGNED UNIT ENCLOSED IN MOLDED PLASTIC CASE

- Plugs into ROM pack slot. Uses tape base software (option of on board ROM)
- No personality modules required
- No switches to fiddle with
- Will program 2500, 2700 and 68700 series EPROM
- High quality zero insertion force EPROM socket
- Gold plated contact (Text Tool™)

REGULAR PRICE \$140.00  
INTRODUCTORY PRICE  
\$110.00

(Offer expires 10/30/83)

### YOUR SOURCE FOR THE COLOR COMPUTER

64K COLOR COMPUTER . . . . .	\$349
DRIVE 0 FOR COCO . . . . .	\$329
DRIVE 1 FOR COCO . . . . .	\$229
DISK CONTROLLER FOR COCO . . . . .	\$139
EXTENDED BASIC ROM . . . . .	\$ 89
SATURN RS-232 EXPANDER . . . . .	\$ 30
SATURN SERIAL INTERFACE . . . . .	\$ 70
POWER-ON L.E.D. KIT . . . . .	\$ 6
FRONT RESET SWITCH KIT . . . . .	\$ 7
BBS SOFTWARE FOR COCO . . . . .	\$200
LIBRARY CASE	
(HOLDS 50 DISKS) . . . . .	\$ 23
NEW MULTI-COLOR	
RAINBOW DISKS . . . . .	\$ 25
ELEPHANT DISKS SSDD . . . . .	\$ 23
8 PRIME 64K RAM-CHIPS . . . . .	\$ 50
F-A-S-T UPGRADE SERVICES . . . . .	\$CALL

### AVAILABLE FROM:

**Saturn Electronics Inc.**  
62 Commerce Dr.  
Farmingdale, NY 11735  
(516) 249-3388



\*Text Tool is a trademark of 3M  
Add 4% shipping and handling. Dealer inquiries invited

# Design And Development Of Application Software

By Paul Searby

Since this is the first time an article by me is appearing in *the Rainbow*, I will first take a moment to give you a brief summary of my background. I have been involved with computers and data processing since 1969, working primarily on larger IBM systems until 1977. During that time, I was primarily involved in the design and development of both financial and manufacturing applications. In October of 1975, I bought, built and programmed the first "personal computer" ever made. It was an Altair 8800 that came in kit form with 1K of memory. Then in March 1976, Southwest Technical Products introduced their Motorola 6800 computer kit, and we immediately became one of their first dealers, operating a small store on a part-time basis. This particular computer is of some interest, because it is basically the great grandfather to the CoCo.

We were having some success with our small enterprise and, in October 1977, I quit my full time job as a Project Manager for a large corporation to devote full-time efforts to our company, Computerware®. It was at this time that we began development of the many system and application software products that are still being marketed today. In fact, today, not only do we provide a large number of products for the CoCo, but still support larger 6809 based systems. Many larger companies, such as Kaypro Corp., use the systems and applications products that we developed.

Although I have not personally programmed every one of the many application packages that we offer, I have always been involved in the design and development. What I have had is an opportunity to see the evolution of a particular series of programs over a period of more than six years, seeing where they did well and where problems occurred. That brings us to the purpose of these articles.

What I will try to do is to cover in fair detail the steps which should be taken in the process of designing and developing a major application. Although the articles should be

of interest to most people, they will be oriented toward the designer and programmer (often one and the same). It will be assumed that this person is not necessarily going to be the user and thus the additional responsibility of ease of use will be ours.

As I discuss our design and programming objectives, you will get the feeling that it is oriented toward a person doing this for commercial purpose, not you doing it for yourself. While that may be the case, I would like to point out that it is from that perspective that better design and programming habits are developed. Today you think that you are writing it for your own personal needs. However, if it is well done and appears to serve a common need, wouldn't it be nice to financially reap a reward for your efforts?

The design and programming will be based on the features, capabilities and limitations of Computerware® *Random BASIC*, which is available for the CoCo on both the FLEX and OS-9 operating systems. As we go, specific examples from existing application programs will be included. However, the reader can use the ideas shown here with almost any other language. As will be mentioned several times in the articles, application software is more often requiring modification than other types of software. Thus, it is a good idea to use a higher level language, which generally makes minor modifications easier to perform.

Although one of the ground rules for these articles was that I will not provide extensive "hand holding," ie, oversimplify, it will be helpful from the onset to provide an overview of the types of software and the characteristics of each in relation to our subject of application software design and development. Basically there are two general categories for software: system software and application software. *System* software is typically considered to be not only the operating system that you are using, but also, the languages (ie, BASIC, PASCAL, FORTRAN, C, etc.) and most utilities.

# !!! FREE !!!

Published Monthly by Computer Publishing Inc., Hixson, TN.

\$1.95



Bulk Rate  
U.S. Postage  
PAID  
Chattanooga, TN  
Permit No. 357

## Color Micro Journal

The Color Computer Monthly Magazine

\$1.95 per issue Vol. 1, Issue 2 October, 1983

### THIS 'N THAT

### OS-9 on the COLOR COMPUTER

The **BIG NEWS** this month is that **OS-9** has finally arrived for the Color Computer. The **ASTOUNDING** part of the Radio Shack OS-9 Package, besides the price, is the **DOCUMENTATION**. You 'Old Time Radio Shack Followers' will not believe what you see. Jon Shirley has been telling us that the main reason for the "lack" of documentation with a lot of their products was the restrictions placed on releasing that information by **Microsoft**: I

One of the "Operating Systems of the Future" is **now available** for the "little old Color Computer"; **OS-9**. Freely translated, OS-9 means "Operating System for the 6809" (OS-9 is now being written for the ~~68000~~, also). Since it is fairly obvious that UNIX and "UNIX-Type" Operating Systems will be running on just about every computer to come out in the next few years, a whole new language is beginning to appear on the horizon.

#### Color Computer OS-9: the Package

We had been running a preliminary release of OS-9 on the Color Computer for a few weeks, and received the "Official Radio Shack" version for Review a couple of days ago. To put it mildly, this package is **IMPRESSIVE!** For \$69.95 (Radio Shack Catalog Number ~~26-3030~~), you receive a 9 1/2" x 7 5/8" x 2" package containing 4

## FREE SAMPLE ISSUE

### 1-800-338 6800

MON.-FRI. 9-5 E.S.T.

USA-\$16.50 per year. Canada & Mexico-\$23.00 per year

Surface Foreign-\$28.00 per year. Airmail Foreign-\$52.00 per year

## Color Micro Journal™

TM Color Micro Journal is a trademark of Computer Publishing Inc.

5900 Cassandra Smith Rd.

Hixson, TN. 37343

# PRO-COLOR-SERIES

**PRO-COLOR-FILE** *Enhanced* \$79.95 D

This high level data base development program offers the ability to track any type of information. From Mailing Lists to Expense Records, to Inventory or Court Trials, PRO-COLOR-FILE has the versatility to handle it.

60 Data fields	8 Report formats
Upto 1020 Bytes per record	Summary Reports
Use 1-4 Disk Drives	Screen Reports
4 Color Data Entry Screens	Page titles, numbering
28 User defined Equations	Sort on any Field
Scan File Alphabetically	Sort 3 Fields at once
Duplicate records	Sort any size file
Duplicate fields	Select sub-sets of file

*Watch For Upcoming  
Review*

**PRO-COLOR-FORMS** \*NEW\* \$39.95 D

Generate customized letters by merging PRO-COLOR-FILE data files with a letter. Print a personalized letter to everyone on your list. PRO-COLOR-FORMS will place data anywhere on a full page, even within the text of a letter.

Embedded control codes	32 to 133 characters
6 User designed forms	7 to 66 lines

*Have your data printed on pre-printed forms or design your own. Requires PRO-COLOR-FILE to use.*

**PRO-COLOR-DIR** \*NEW\* \$24.95 D

Compile a master listing of all your directories in one data file. This utility program will read a diskette's directory and place the information in one master file. PRO-COLOR-FILE is then used to generate reports or search and update. PRO-COLOR-DIR will store:

Diskette ID name	Date Created
File name/Extension	Date Updated
File type (Basic, ML, Data)	Number of Grans allocated
Number of Sectors allocated	Number of Sectors used
ML Load and Execute address	ML file length

*Store 1000 entries! Requires PRO-COLOR-FILE to use.*

See your local dealer or send check or money order to:  
Derringer Software, P.O. Box 5300, Florence, SC 29502  
Visa, MasterCard customers call (803) 665-5676 after 6 pm.  
Add \$2.00 for Shipping and Handling No C.O.D.'s

PRO-COLOR-FILE, PRO-COLOR-DIR,  
PRO-COLOR-FORMS (C) 1983  
Derringer Software  
All programs require 32k Color Computer Disk System  
(Does not require joysticks!)

System software may or may not be flexible to use, but in either case, it is not often subject to change. As with the CoCo, BASIC is in ROM format, which does make it a little difficult to modify. Instead of modifying system software, usually a deficiency is overcome by someone writing a utility that provides the needed feature.

The other category, application software, is split into two areas: generalized packages and specialized packages. For the purpose of this discussion, we will consider data base programs, calculator programs, word processing, etc., to be in the generalized area. The specific area would include many financial packages such as Accounts Receivable, Accounts Payable, General Ledger, Payroll, along with Inventory, Job Costing, etc.

The generalized packages have strengths in being more flexible, allowing the user to "customize" to their needs. Unfortunately, this added flexibility also brings with it areas of weakness, in that many of the packages are more difficult to set up. What becomes common is the sale of specific "templates" or predefined designs for the general purpose packages to use. On the strong side of specific packages is that they can deal with the subject at hand in greater detail

---

"[Accountability] . . . is valuable from two points of view: it is quite helpful in debugging the programs, and it gives the user some of the checks and balances that are required in financial applications."

---

and, in most cases, are quite easy to use. They can include complex file structures that just aren't available with the generalized programs. However, one of their major shortcomings is that, in most cases, a programmer is required to make any changes. The amount of expense involved will be determined by not only the complexity of the changes, but also how well the programs and system was designed. This brings us back to what these articles are all about. . . .

The last area of discussion in this month's article will be an overview of design criteria. Not particularly listed in their order of importance, the following are our major design criteria: "maintainability"/modifiability, ease of use, accountability, and target system capabilities. Regarding maintainability and modifiability, in the real world, many businesses have unique needs in the area of computer software requirements. Many of them can be satisfied with generalized application packages, however, others require features that can't be accomplished with a generalized package. So, we look for software that is specific to the needs of the user.

The typical situation is one where we find something very close, but not quite right. Assuming this from the beginning, we should design maintainability and modifiability into our programs. I adhere to the "KISS" philosophy: (K)eepl (I)t (S)imple, (S)tupid! We want to design simple "black box" modules that can be common to any programming, not only in our modules, but also in our mainline. This will cost us some space, and so will good variable names and comments when required, but it can save us many, many hours of



Radio Shack  
Color Computer  
TDP System 100



# ROAR!

Do tricks with your computer without breaking your wallet's spirit! A subscription to **Chromasette** gets you a tape or disk full of quality programs delivered by First Class Mail every month! Write for more information or, better yet, try a Back Issue. At \$6.00 for 6 to 8 programs on tape (\$11.00 on disk), you'll see just how good and inexpensive **Chromasette** software is.

The Bottom Line:	Tape	Disk
1 year (12 issues)	\$50.00	\$95.00
6 months (6 issues)	\$30.00	\$55.00
Single Issues	\$ 6.00	\$11.00

Calif. residents add 6% to single issues. First Class postage to N. Amer. included. Overseas add \$10 to subscriptions and \$1 to single issues. Sent AO rate. All back issues from July 1981 available—ask for list. Programs are for the Extended BASIC model and occasionally for disks.



**Chromasette**

P.O. Box 1087 Santa Barbara, CA 93102  
(805) 963-1066

debugging. This time savings isn't just at programming time, but also six months down the road when we again have to understand what we did. We will also want to put a lot of thought into the file structure before we even come near the programming stage. More on this later.

As was mentioned earlier, we will assume the responsibility for ease of use. We may not even know who is using the software, and definitely do not want to spend time on the phone with each user to get them up and running. This is bad from a public relations point of view, and also means that valuable programming or marketing resources are tied up not doing what they should be doing. Going one further, we will assume that even though we will have a good manual, most users don't really read the manual as completely as they should. This isn't a slight on users, it's a realistic observation made over the past six years. Therefore, we want to use easy selection menus and provide as much guidance as possible within the programs.

As to accountability, this means that the software should provide some form of an audit trail. Can we trace what happened? This is valuable from two points of view: it is quite helpful in debugging the programs, and it gives the user some of the checks and balances that are required in financial applications. In this same area, the software must comply with accepted practices. If in the financial area, it must not only be accurate, and provide a method of balancing, but should in most cases, not allow the user to get it "out of balance."

Lastly, target system capabilities must be taken into consideration. If the vast majority of users have only 16K cassette-based systems, designing for a quad-drive 64K computer may not be where it's at. You are better off to re-think the desired capabilities and come up with ones that will fit the systems of today, *but* designed for easy expansion in the future.

In the next article, we will get into more depth on our design, along with exploring the use of top down design as a tool to improve our design objectives.

See you at  
**RAINBOWfest**  
Feb. 17 — 19

TRS-80  
COLOR  
COMPUTER



# STEAL

The best out of our library of over 200 published programs, packaged and priced so low that it seems like robbery:

**Games #1** - Action-packed, logical, and colorful ones! Flyby, Blackjack, Motorcycle, Germ, Blockade, Life, Diggem, Robot Run, Stellar Empire, and Zero G for your fun and pleasure!

**Adventures #1** - Trips to far-off and dangerous places. On the agenda are Jerusalem Adventure, Ultimate Adventure, Williamsburg Adventure, House Adventure, Andrea Doria Adventure, Blackard's Castle, and Realm of Nauga!

**Practicals #1** - Programs for text editing, maillists, budgeting, filing, etc. including Keypertext, Keep Address, Keeplist, Keepcheck, Keep Budget, Files, and Tape Inventory.

**Graphs & Charts #1** - For data manipulation and display! Do it with Pie Chart, Bar Chart, XY Graph, Curve Fit, and Two Dates.

Choose any one of the four packages for just \$12.00 (\$17.00 on disk)!

**SILVERWARE**

- a lot of software for a little silver

See your dealer or  
Write or call us direct at P.O. Box 21101,  
Santa Barbara CA 93121 (805) 966-1449

# Prospecting The MC-10

By H. Allen Curtis

**T**his article, like that of Tom Szlucha in the September issue of *the Rainbow*, deals with the hidden commands of the MC-10. Tom, in his article, lamented the MC-10's lack of a *CSAVEM* command. To offset this deficiency, I am presenting herein a short program simulating such a command. My article was written to act as an addendum to the MC-10 manual.

There's gold to be found in the ROM of the MC-10 computer. Some prospecting with *PEEKs* reveals three tables—a table of BASIC key words, a table of entry addresses to ROM subroutines for each of the BASIC statements of MC-10, and a similar address table for the BASIC functions. These tables can be found at ROM addresses 57413-57670, 57672-57737 and 57344-57391, respectively. The information contained in those tables are recorded and consolidated in Tables 1, 2, and 3.

Table 1 contains the BASIC key words of BASIC statements along with their associated ROM routine entry addresses and tokens. The addresses and tokens are given in both decimal and hexadecimal notations. A token is a single byte that represents the key word when it is stored in the BASIC program.

Table 2 contains the BASIC functions, their ROM entry addresses and tokens.

Table 3 contains logical operators, arithmetic operators and BASIC words having no ROM routines of their own.

*(H. Allen Curtis, who earned degrees from the College of William and Mary, M.I.T., and Harvard, recently won an award for meritorious service from the IEEE Computer Society. He has had published a college reference book in the computer science field as well as many papers and articles.)*

TABLE 1

WORD	DECIMAL		HEX	
	ADDRESS	TOKEN	ADDRESS	TOKEN
FOR	58564	128	E4C4	80
GOTO	58906	129	E61A	81
GOSUB	58884	130	E604	82
REM	59013	131	E685	83
IF	58994	132	E672	84
DATA	58961	133	E651	85
PRINT	59167	134	E71F	86
ON	59026	135	E692	87
INPUT	59358	136	E7DE	88
END	58751	137	E57F	89
NEXT	59579	138	E8BB	8A
DIM	60178	139	EB12	8B
READ	59406	140	E80E	8C
LET	59091	141	E6D3	8D
RUN	58874	142	E5FA	8E
RESTORE	58720	143	E560	8F
RETURN	58929	144	E631	90
STOP	58750	145	E57E	91
POKE	61286	146	EF66	92
CONT	58790	147	E5A6	93
LIST	58381	148	E40D	94
CLEAR	58808	149	E5B8	95
NEW	58317	150	E3CD	96
CLOAD	64860	151	FD5C	97
CSAVE	64571	152	FC3B	98
LLIST	58379	153	E40B	99
LPRINT	59164	154	E71C	9A
SET	64293	155	FB25	9B
RESET	64341	156	FB55	9C
CLS	64447	157	FBBF	9D
SOUND	65445	158	FFA5	9E
EXEC	65516	159	FC04	9F
SKIPF	65071	160	FE2F	A0

TABLE 2

WORD	DECIMAL		HEX	
	ADDRESS	TOKEN	ADDRESS	TOKEN
SGN	62138	177	F2BA	B1
INT	62261	178	F335	B2
ABS	62165	179	F2D5	B3
USR	16917	180	4215	B4
RND	63018	181	F62A	B5
SQR	62797	182	F54D	B6
LOG	61625	183	F0B9	B7
EXP	62921	184	F5C9	B8
SIN	63116	185	F68C	B9
COS	63110	186	F686	BA
TAN	63186	187	F6D2	BB
PEEK	61279	188	EF5F	BC
LEN	61058	189	EE82	BD
STR\$	60653	190	ECED	BE
VAL	61212	191	EF1C	BF
ASC	61090	192	EEA2	C0
CHR\$	61070	193	EE8E	C1
LEFT\$	61101	194	EEAD	C2
RIGHT\$	61128	195	EEC8	C3
MID\$	61135	196	EECF	C4
POINT	64412	197	FB9C	C5
VARPTR	64529	198	FC11	C6
INKEY\$	64493	199	FBED	C7
MEM	60635	200	ECDB	C8

TABLE 3

WORD	DEC TOKEN	HEX TOKEN
TAB(	161	A1
TO	162	A2
THEN	163	A3
NOT	164	A4
STEP	165	A5
OFF	166	A6
+	167	A7
-	168	A8
*	169	A9
/	170	AA
↑	171	AB
AND	172	AC
OR	173	AD

There is some gold dust in Table 3: The appearance of [↑] among the arithmetic operators indicates accurately that the MC-10 has the previously undocumented ability to raise numbers to powers. However, heavy gold nuggets are found in Tables 1 and 2. Table 1 shows the existence of the *EXEC* command, a command not mentioned in the MC-10 manual. Table 2 reveals that there are two functions, *USR* and *VARPTR*, that are also unmentioned in the manual.

The three uncovered nuggets provide convenient means of accessing machine-language routines and programs. Finding the three nuggets made me suspect that there might be more gold hidden in some of the commands described in the manual. Maybe some of their features were left undescribed. My suspicions were soon confirmed. I found that appending the suffix *M* to *CLOAD* produces a variant of that command that will load machine language programs. Moreover, the *CLEAR* command has facilities for protecting memory space at the high address portion of the RAM, where machine-language routines can be *POKEd*.

Unfortunately, the MC-10 has no *CSAVEM* command to record machine-language programs on tape. To remedy this deficiency I have written a program that will simulate a *CSAVEM* command. The presentation of this program will be used to illustrate how the *CLEAR* and *EXEC* are used.

**B**efore the presentation is made, it is worthwhile interjecting some remarks about machine language programs and BASIC programs using machine language routines. Sooner or later you will probably encounter problems whose solutions require programs that must execute with speed and economy of memory usage which cannot be achieved with BASIC alone. Machine language programs can provide maximum execution speeds and memory economy. However, such programs are usually complex and much more difficult to write and debug (locate programming errors). Often the best solution is a BASIC program with a few strategically chosen machine language routines. Such a program combines the simplicity of BASIC and the speed and economy of machine language.

It is hoped that this article will stimulate the use of machine language programming. Writing machine language programs and routines requires familiarity with assembly language programming and the 6803 microprocessor's instruction set. Towards gaining this familiarity, it is suggested that you read "BASIC Microprocessors and the 6800," Ron Bishop. Hayden Book Co., 1979.

In Listing 1 is shown the program for saving machine language programs. Using the *CLEAR* command, the program protects the final 53 bytes of the MC-10 RAM. Then it *POKEs* 53 bytes comprising the machine language program into the protected memory area. This memory area is protected in the sense that the memory areas for the BASIC program, its associated variables, and the BASIC stack will not encroach on the protected RAM. After the machine language program is *POKEd* into high RAM, the *EXEC* command provides a means of entry from BASIC to the machine language program.

In line 10 of Listing 1, the first address of the protected memory area is calculated. The number,  $256 * \text{PEEK}(16976)$ , is the highest RAM address minus 255. The address given by *X* in line 10 is 20427 for a 4K byte RAM or 36811 for a 20K byte RAM. In line 20 *CLEAR* 100, *X-1* reserves 100 bytes of string memory and protects all memory beyond *X-1*. The *CLEAR* command also initializes all variables. Hence, the first address of the protected RAM, which also happens to be the entry address of the machine language program, must be recalculated in line 30.

Line 70 is included to prevent the execution of the machine language program when one or more of the *DATA* statements of lines 90 through 170 have been typed incorrectly. In line 80 *EXEC X* initiates the execution of the machine language program at the entry address *X*.

**W**hen you have keyed in the program without any typing errors and run it, you will see a question mark (?) prompt and a flashing cursor. For the present, ignore the prompt and press [BREAK]. *SAVE* the program on tape for future reference. Then rerun the program and answer the prompt by typing in decimal the first address of the program to be saved, then its last address, next its entry address, and finally a filename. The typing format is as shown in the REM of line 5. A comma must follow each address, and the filename must contain eight or less characters enclosed by quotes. The three addresses for the machine language pro-

# BLACKJACKPRO



## BLACKJACKPRO

A computer assisted learning tool  
to condition you to make  
the right play effortlessly  
and beat the house.

Read about BLACKJACKPRO on page 145

BLACKJACKPRO is a trademark of Skillware Corporation

# SKILLWARE

*“Machine language routines that are integral parts of a BASIC program can be stored in protected high RAM. However, frequently to reduce memory consumption it is convenient to store machine language routines in strings.”*

gram now residing in the protected high RAM are 20427, 20479, and 20427, respectively, for a 4K RAM and 36811, 36863 and 36811, respectively, for a 20K RAM. *CSAVEM* is an appropriate filename for the program.

After typing the addresses and filename, pressing [ENTER] initiates the recording process. Therefore, before you press [ENTER], be sure that you have properly positioned your the tape and have depressed the record and play buttons of your recorder. If you make a typing mistake, you may get an error message instead of recording. In such a case, use *EXEC* again and repeat the

process.

When you have a good recording of the program, *CSAVEM*, turn your computer off and then on again. Now with an empty RAM you can use the *CLOADM* command to test whether or not *CSAVEM* works properly. Before loading, protect the top of the RAM for *CSAVEM* by typing and entering the following:

```
CLEAR 100,256*PEEK(16976)+202
```

Then type *CLOADM"CSAVEM"* if you rewind to the beginning of the tape, or merely use *CLOADM* if you position

the tape between the two programs recorded. Then press [ENTER] and you should shortly get the OK prompt. To make entry to *CSAVEM*, merely type *EXEC* and press [ENTER]. *CLOADM* provides the entry address.

There is another interesting feature of the *CLOADM* command that has facilities which allow you to load a program in different portions of the RAM. Using *CLOADM* with the format — *CLOADM* “filename”,n — where n is a decimal address offset, you can load the program into an area whose first address is n greater than the recorded first address of the program. To load the program into an area whose first address is n less than the recorded first address, you must use 65536-n instead of n.

To see how this feature works, try loading *CSAVEM* at a memory area from 19427 through 19479 for a 4K RAM or from 35811 through 35863 for a 20K RAM. Before loading, *PEEK* at the contents of 19427 or 35811 depending on the size of your RAM. That is, type and [ENTER] either: PRINT PEEK(19427) or PRINT PEEK(35811) respectively. Remember this number for future comparison with the contents of that address after loading. Position the tape for loading. Then type *CLOADM* “*CSAVEM*”,64536 and press [ENTER]. Depress the play button. After the OK prompt appears, *PEEK* at the contents of 19427 or 35811 again. If the address now contains 206, you have verification that the offset feature of the *CLOADM* command works as described. Entry can be made by means of *EXEC* as before.

This feature of *CLOADM* must be used with caution. The program to be loaded must be relocatable, that is, it must have the ability to execute properly regardless of its location in RAM. *CSAVEM* was purposely written to be relocatable for your convenience and the safe application of the *CLOADM* offset feature.

Machine language routines that are integral parts of a BASIC program can be stored in protected high RAM. However, frequently to reduce memory consumption it is convenient to store machine language routines in strings. Once a machine language routine is “packed” in a string, the *READ-DATA-POKE* sequence of instructions can be deleted from the BASIC program. These deletions can be safely made because the machine language routines are embedded in the BASIC program and will be loaded as a part of that program.

Don't bang your head  
against a brick wall looking  
for that perfect gift!

**the Rainbow** 9529 U.S. Highway 42  
502/228-4492 P.O. Box 209  
Prospect, Ky. 40059

**I would like to send a gift certificate for a one year (12 months)  
subscription to:**

Name \_\_\_\_\_  
Address \_\_\_\_\_  
City \_\_\_\_\_ State \_\_\_\_\_ Zip \_\_\_\_\_

+++++

**From:**

Name \_\_\_\_\_  
Address \_\_\_\_\_  
City \_\_\_\_\_ State \_\_\_\_\_ Zip \_\_\_\_\_

Payment Enclosed

Charge  VISA  MasterCard  American Express

My Account# \_\_\_\_\_ Interbank# (MC only) \_\_\_\_\_

Signature \_\_\_\_\_ Card Expiration Date \_\_\_\_\_

**GIVE 'EM THE RAINBOW!**

**THE SOLID MONTHLY  
FOR COCO USERS!!**

Subscriptions to the Rainbow are \$25 a year in the United States, Canadian and Mexican rate, U.S. \$35. Surface rate to other countries is U.S. \$65, air rate U.S. \$100. All subscriptions begin with the current issue. Please allow up to 5-8 weeks for first copy.

Just for your  
TRS-80™ COLO®  
TDP System 100  
Dragon 32  
MC-10

The *VARPTR* function is often used to determine the first string address into which to *POKE* the machine language routine as well as to provide the entry address. The program of Listing 2 is the same as that of Listing 1 except for lines 10, 20 and 30. Therefore, load the previously saved program of Listing 1 and type in the new lines 10, 20 and 30.

The five sequences of 1234567890 followed by 123 in the string *A\$* of line 10 provide the needed space for the 53 byte machine language routine. If you type more or less than 53 characters into *A\$*, then the program will stop at line 20. In line 20, *B=VARPTR(A\$)* is the address containing the number corresponding to the length of string *A\$*. In line 30, *X* is the address of the first character in the string *A\$*.

When you have completed typing and entering lines 10, 20 and 30, run the program. Break out of the question mark prompt and notice how string *A\$* has changed in line 10. Don't worry, this colorful but unintelligible representation of the machine language program is correct. Delete lines 40 through 70 and lines 90 through 170. Now, you have a short BASIC version of the program to save machine language programs. Save it on tape.

It should be pointed out that strings may not be packed with any byte having a value 0 or 34. The ASCII code that is 0 provides the end of BASIC line signal, and 34 is the ASCII code for quotes. Note that *DATA* statements 90 through 170 did not contain any 0s or 34s.

The *EXEC* command is limited in scope compared with the *USR* function. The *USR* function not only provides means of entry to and exit from machine language routines, but also is the mechanism for passing information back and forth between the BASIC program and its machine language routines.

The program of Listing 3 is used to illustrate the workings of the *USR* function. The machine language routine is *POKEd* into the string *A\$* of line 10. The machine language routine performs the arithmetic function *SQR(ABS(2\*INT(N)))* where *N* is a number that you enter in response to the *INPUT* statement of line 100. Ordinarily you would employ BASIC programming to perform the aforesaid arithmetic function. There is no real advantage doing it in machine language. The routine was written solely to illustrate *USR* function properties.

*VARPTR* is used to determine the address of the first character in the string *A\$*. In line 30, *M* is the most significant byte of the first address of the machine language routine, *L* is the least significant byte of that two byte address. The first address of the routine is also its entry address.

In line 90 the two bytes of the entry address are *POKEd* into addresses 16918 and 16919. In Table 2 note that the entry address for the *USR* function is 16917, a RAM address. At 16917 is the operation code for the 6803 microprocessor's *JUMP* (*JMP* for short) instruction which is analogous to BASIC's *GOTO*. The *POKEing* done in line 90 allows the *USR* function to make entry to the machine language routine.

The value of the variable *N* in the *USR* function of line 110 is the information that is passed from the BASIC program to the machine language routine. Each of the lines 130 through 170 contains a 6803 instruction which after the *READ-DATA-POKE* sequence is packed into the string *A\$*. The 6803 instructions are usually represented in either hexadecimal or mnemonic forms rather than in decimal. Table 4 shows the five 6803 instructions of the machine language routine in their hexadecimal and mnemonic forms:

Table 4

Hex	Mnemonic
BD EB CA 05	JSR FACTOD ASL D
BD EC E3	JSR DTOFAC
BD F2 D5	JSR ABS
7E F5 4D	JMP SQR

The mnemonic forms provide abbreviated descriptions of what the instructions do. Therefore, they are the easiest forms to use in programming. The *JSR* instruction, for instance, is analogous to BASIC's *GOSUB* command. *JSR* is a jump to a machine language subroutine. *FACTOD* in *JSR FACTOD* is a label assigned by the programmer to the entry address of the subroutines. The label describes what the subroutine does. In this case, the subroutine transfers the value of *N* from BASIC's floating point accumulator to the 6803 microprocessor's accumulator *D*. In the process of making the transfer the value of *N* is converted into an integer. The instruction *ASL D* does an arithmetic shift left one bit position of *D*, which is equivalent to multiplying the contents of *D* by two. *JSR DTOFAC* transfers the contents of *D* to *FAC*. *JSR ABS* makes the number in *FAC* positive. Note the address, *F2D5*, corresponding to the label *ABS* is precisely the entry address of the ROM routine for BASIC's *ABS* function given in Table 2. Finally, *JMP SQR* causes the square root of the contents of *FAC* to be taken and returns the result to BASIC. The address *F54D* corresponding to the label *SQR* is also found in Table 2. As you might suspect, Tables 1 and 2 furnish valuable information to the machine language programmer.

In general, the information passed from BASIC to a machine language routine is stored in *FAC*. When you wish to perform integer arithmetic on the passed information, you must transfer the contents of *FAC* to *D*. Hence, *JSR FACTOD* should be a very frequently used instruction. The final contents of *FAC* are the value that gets returned to BASIC. The final instruction used to exit from a machine language and return to BASIC is always *RTS* (Return from Subroutine and is 39 in hexadecimal form). This statement seemingly contradicts the fact that the machine language routine associated with the program of Listing 3 ends with *JMP SQR*. Each ROM subroutine is terminated with an *RTS*. Using *JMP* instead of *JSR* makes the *SQR* subroutines' *RTS* exit the return to BASIC exit.

It is hoped that you will manufacture many beautiful golden objects with the ore mined in this article.

#### Listing 1 (MC-10):

```
5 REM FIRST, LAST, START, "FILENAME
"
10 CLS: X=256*PEEK(16976)+203
20 CLEAR 100, X-1
30 X=256*PEEK(16976)+203
40 FOR Z=X TO X+52
50 READ Y: W=W+Y: PRINT Z, Y: W
60 POKE Z, Y: NEXT
70 IF W<>8373 THEN PRINT "DATA ERRO
```



# PRICKLY-PEAR SOFTWARE

QUALITY PROGRAMS FOR YOUR COCO & TDP-100  
PROGRAMS REQUIRE 16K EXTENDED BASIC FOR TAPE, AND 32K DISK UNLESS OTHERWISE NOTED.

## # 1 WITH UTILITIES

# COLOR KIT



## COLORKIT

We are proud to announce that the **COLORKIT**, written by George Zinowitz, and formerly marketed by Arizin Inc. of Scottsdale, Az., is now one of the broad line of Prickly-Pear Software utilities.

This programmer's aid is truly an amazing program. First the small stuff. With the **COLORKIT** you have your choice of light or dark screen, and you can have a key-click if you like. You can easily disable the BREAK key also, and you can slow your listings down to a readable speed.

In addition, you get an outstanding FULL SCREEN EDITOR while retaining the standard editor. You can list all the variables currently being used in a program. You can merge machine language programs and BASIC programs into a single unit that can be saved or loaded easily. You can do a global search through your program for any target you specify. You

can easily examine or move sections of memory. You can echo all screen output to the printer. You can easily recover a program lost because of a NEW, BACKUP, or DSKINI command. You can print the addresses of the last machine language program loaded. You can get a help file on the screen showing all commands. You can program 10 function keys with up to 250 keystrokes each.

Whew!! We're running out of breath, but you can believe we are not running out of features! The incredible thing is that all of these functions are easy to use. They are accessed by simple one word commands. What the program really does is add a lot of commands to BASIC that should be there but aren't. Did you type NEW by mistake? No problem — just type .OLD and the program is back! The other features are just as easy to use. The program comes with a 20 page manual which fully explains all of the features.

This program is about 6K long and is 100% machine language and 100% relocatable. It runs in computers 16K or larger. If you have 64K you can put it up high, and it uses no BASIC space at all. The same program will work equally well on disk or non-disk machines. Step up to the program that REALLY extends your BASIC, and take full advantage of all the great programmer's tools you've been missing. **On tape — \$34.95. Same program on disk — \$39.95.**

Programs are available on AMDEK cartridges - add \$5.00 to the disk price.

Your personal check is welcome - no delay. Include \$1.50 shipping for each program ordered. (Shipping free on \$50.00 or larger orders). AZ residents add 7% sales tax. Orders shipped within two days.

Stocked by Quality Dealers, or

Send Order To: **PRICKLY-PEAR SOFTWARE**

9234 E. 30th Street  
Tucson, Arizona 85710  
(602) 886-1505





# CHROMA SYSTEMS GROUP



## EUCHRE!

A Hi-Res version of the card game. Your partner is the computer, the opponent team is played by the computer. Allows any of the four players to "GO" alone.

(ECB, 32k)  
Cassette

\$19.95



## DSKMON!

Examine and fix sector data, also includes disk read/write, file information display, and selective disk backup.

(ML, 16k or 32k)  
Disk (With Source)

\$24.95

## MORE CSG PROGRAMS!

### UTILITIES

**CCADS** — A full 6809 machine language monitor with line assembler and disassembler. All you need to debug machine language programs.

(ML, 16k or 32k)  
Cassette \$19.95 or Disk (With Source) \$23.95

**UNLOCK** — A complete disk backup utility. Features included are initialization of any track, copy any track and correct I/O errors, or leave them intact, and verify any track. Track numbers up to track 80 may be used at any time.

(ML, 16k or 32k)  
Disk (With Source) \$24.95

**CHROMA-KEYS** — Define function keys and save them to disk or cassette.

(ML, 16k or 32k)  
Cassette \$9.95 or Disk (With Source) \$13.95

**SPOOLER** — Print ASCII files from disk without waiting.

(ML, 16k, 32k, or 64k only)  
Cassette \$11.95 or Disk (With Source) \$15.95

**COMMAND** — Add machine language programs as commands to BASIC.

(ML, 16k or 32k)  
Cassette \$15.95 or Disk (With Source) \$19.95

### GAMES

**PROSPECTOR** — An ECB Hi-Res graphics game. Can you get the gold out of the mine?

(ECB, 16k or 32k)   
Cassette \$7.95

**JUMP-A-PEG** — A Hi-Res version of an ancient strategy game.

(ECB, 16k or 32k)   
Cassette \$7.95

### MISCELLANEOUS

**CLOCK** — A software real-time clock program for the CoCo. Warning: The clock will stop during tape I/O.

(ML, 16k or 32k)  
Cassette \$9.95 or Disk (With Source) \$13.95

**DARKROOM DATABASE** — Throw away your Photo-Lab index. Let CoCo look up the facts. Darkroom Data-Base with timer.

(Disk, 16k or 32k)  
Disk \$19.95

**COMING SOON**

MC-10 SOFTWARE! Write for more details.

**CHROMA SYSTEMS GROUP**

P.O. Box 366

Dayton, Ohio 45420

Please include \$1 for shipping and handling per item. Ohio residents please add 6% sales tax.

R": STOP

80 EXEC X:END

90 DATA 206,66,178,223,244,189  
100 DATA 231,255,189,239,76,255  
110 DATA 66,108,189,234,47,189  
120 DATA 239,76,8,255,66,113  
130 DATA 189,234,47,189,239,76  
140 DATA 255,66,106,189,234,47  
150 DATA 134,2,183,66,103,189  
160 DATA 252,139,254,66,108  
170 DATA 189,252,96,189,226,113

Listing 2 (MC-10):

5 REM FIRST, LAST, START, "FILENAME  
"

10 CLS: A\$="123456789012345678901  
23456789012345678901234567890123  
"

20 B=VARPTR(A\$): IF PEEK(B) <> 53 THE  
NSTOP

30 X=256\*PEEK(B+2)+PEEK(B+3)

40 FOR Z=X TO X+52

50 READ Y: W=W+Y: PRINT Z, Y; W

60 POKE Z, Y: NEXT

70 IF W <> 8373 THEN PRINT "DATA ERRO  
R": STOP

80 EXEC X:END

90 DATA 206,66,178,223,244,189

100 DATA 231,255,189,239,76,255

110 DATA 66,108,189,234,47,189

120 DATA 239,76,8,255,66,113

130 DATA 189,234,47,189,239,76

140 DATA 255,66,106,189,234,47

150 DATA 134,2,183,66,103,189

160 DATA 252,139,254,66,108

170 DATA 189,252,96,189,226,113

Listing 3 (MC-10):

10 CLS: A\$="1234567890123"

20 B=VARPTR(A\$): IF PEEK(B) <> 13 THE  
NSTOP

30 M=PEEK(B+2): L=PEEK(B+3)

40 X=256\*M+L

50 FOR Z=X TO X+12

60 READ Y: W=W+Y: PRINT Z, Y; W

70 POKE Z, Y: NEXT

80 IF W <> 2375 THEN PRINT "DATA ERR  
OR": STOP

90 POKE 16918, M: POKE 16919, L

100 INPUT "ENTER A NUMBER BETWEEN  
-30000 AND 30000. "; N

110 PRINTUSR(N)

120 GOTO 100

130 DATA 189,235,202

140 DATA 5

150 DATA 189,236,227

160 DATA 189,242,213

170 DATA 126,245,77



From the Creators of Rainbow-Writer . . .



## RAINBOW SCREEN MACHINE

## SUPER SCREEN MACHINE

The Rolls Royce of graphics/text screen enhancers — more features than all others combined!

- Add these features to your computer/program: ME extension of Basic loads on top of 16, 32, or 64K machines to enable easy mixture of hi-res graphics and text in your programs. Dense text or large lettering for children, visually impaired or VCR title screens with no programming!
- User definable 224 character set featuring lower case descenders, Greek, cars, tanks, planes, etc., completely interfaced with all keys, commands, and PMODES. 12 sizes (most colored) from 16x8 to 64x24.
- 2 distinct character sets automatically switch for sharpest lettering featuring underline, subscript, superscript, reverse video, top and bottom scroll protect, double width, colored characters in PMODE 4, and help screen.
- Simple 2-letter abbreviated commands inside your program or control key entry from keyboard, even during program execution!
- Includes demo program, character generator program and manual. 16K Ext Basic required - 32K recommended. \$29.95 Tape, \$32.95 Disk.

Revolutionary — heralded as the most useful, powerful and versatile state-of-the-art utility ever developed for the Color Computer!

- All of the features of Screen Machine and more.
- Variable SMOOTH Scroll for professional displays, listings, business use.
- Variable volume Key Click (tactile feedback)
- EDTASM+ command for instant compatibility with R.S. editor-assembler cartridge, providing 64x24 display.
- Superpatch+ command for instant compatibility with disk EDTASM.
- True Break key disable and recognition.
- 10 User Definable commands used to activate your special drivers or subroutine.
- Dynamic Screen Dump command for use with Custom Software Engineering's Graphic Screen Print program for simple printer "Snapshots" of your screen even during program execution!
- The new standard — Upgradeable at any time from previous Rainbow-Writer or Screen Machine purchase. Return old program, manual, plus cost difference and \$7.00 shipping and handling.
- Super Screen Machine \$44.95 Case - \$47.95 Disk.



**RAINBOW  
CONNECTION  
SOFTWARE**

**RAINBOW CONNECTION  
SOFTWARE**

1514 2nd Place NW, Suite D  
Richdale, MN 55901  
507/281-4424

YES, I want to order today during this hot sale for the best SCREEN ENHANCER on any Color Computer. Please bill for me, no cash on delivery. MAILED, printed address, please!

Super S.M. - \$29.95 Tape - \$32.95 Disk

Super S.M. - \$44.95 Case - \$47.95 Disk

Name \_\_\_\_\_

Address \_\_\_\_\_

City & State/Zip \_\_\_\_\_

Phone \_\_\_\_\_

TOTAL \_\_\_\_\_

NAME \_\_\_\_\_

ADDRESS \_\_\_\_\_

CITY \_\_\_\_\_

STATE \_\_\_\_\_

Please check your order \_\_\_\_\_

Send SASE for catalog.

Not shipped with

THE RAINBOW



# OS-9 Meets The Wolfbug Monitor

By William C. Clements, Jr.

The Wolfbug monitor program, sold by Atomic City Electronics, is a handy machine language utility for the 64K CoCo owner. It furnishes memory, examine/change, ASCII dump, and other functions common to most monitors, and also has commands for switching into the 64K RAM mode and for transfer of BASIC into RAM. The monitor is supplied in a 2716 EPROM that's used in a special circuit board which plugs into one of the BASIC ROM sockets. The EPROM resides in memory space between \$F800 and \$FFFF, with the chip-select provided by on-board gates connected directly to CoCo's address lines. A "decode defeat" signal disables the 74LS139 decoder in the computer so that addresses inside the \$F800-\$FFFF, that address range is therefore effectively removed from control of the SAM chip.

When the computer is used in the 32K RAM-32K ROM mode, there's no problem, because the addresses that Wolfbug occupies aren't otherwise used. However, in the 64K RAM mode, the overriding of the SAM's control means that you lose the use of the RAM between \$F800 and \$FFFF. Unfortunately, that's where the kernel program of the new Radio Shack version of OS-9 resides, so attempts to boot OS-9 will crash a Wolfbug-equipped computer.

What's needed is a way to switch Wolfbug in and out of the memory map, so that it can be turned off easily before booting OS-9. Fortunately, that is easy to provide. A single pole, double-

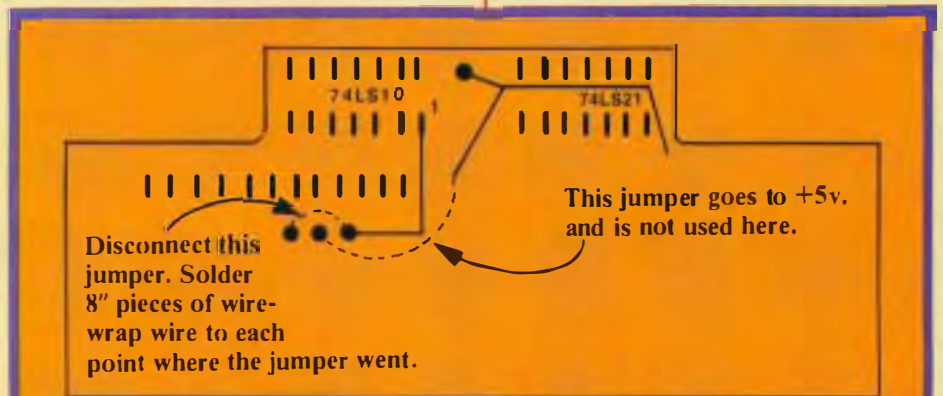

FIGURE 1. Bottom Side of Wolfbug Circuit Board

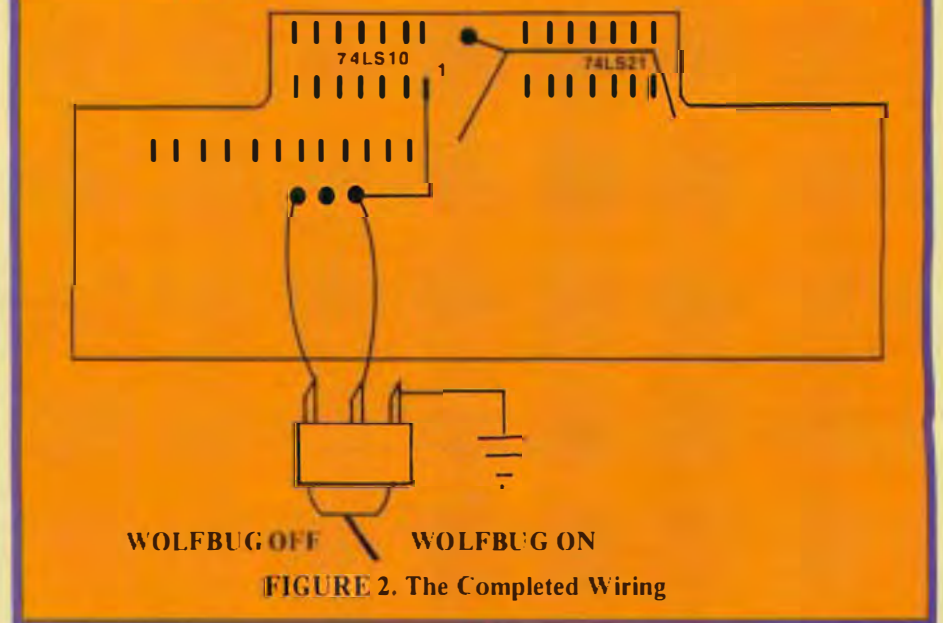

FIGURE 2. The Completed Wiring

*"What's needed is a way to switch Wolfbug in and out of the memory map, so that it can be turned off easily before booting OS-9. Fortunately, that is easy to provide."*

throw switch will let you choose between Wolfbug and OS-9.

The circuit diagram supplied with the Wolfbug kit shows that there are several places to interrupt the address decoding. The circuit board is provided with wire jumpers that allow the selection of either a 2K (2716) or a 4K (2532) EPROM. It is supplied from the manufacturer configured for 2K, but the jumpers are available if one wants to change the circuit. Probably the easiest way to disable Wolfbug is to remove the jumper connected to pin 1 of the 74SL10 and switch pin 1 to ground. That chip contains 3-input NAND gates, one of whose output forms the EPROM chip-select signal. Grounding any NAND gate's input freezes the output in the "high" state regardless of the condition of its other inputs. Pin 1 is switched back to its original connection to restore Wolfbug to the memory space.

To do it, refer to Figures 1 and 2, and follow the steps given below. Incidentally, on the circuit diagram included with my unit, the connections to pins 1 and 2 of the 74LS10 were reversed from the ones actually on the circuit board. The instructions given below are consistent with the actual circuit. Both pins 1 and 2 are inputs to the gate that generates the EPROM select signal, however, so it wouldn't make any difference which one you switch to ground.

1) Remove the computer's cover and set it aside.

2) For computers having the "E" revision circuit board or earlier, the Wolfbug board is located under the RF shield. If that is the case in your machine, gently pry off the RF shield. Carefully pull the Wolfbug circuit board straight up and out of its socket. Turn the board upside down, being careful not to damage the wires attached to it.

*(Dr. Bill Clements, a professor of chemical engineering at the University of Alabama, designs peripherals and programs for his department's student computer facility [all CoCos]. His major interests are in process control and microcomputer applications.)*

3) Locate the short jumper wire that is connected between the outside holes of the three pads below the 74LS10, as shown in Figure 1. Unsolder both ends of the jumper wire and discard it. Solder a piece of wire-wrap wire about 8 inches long into each of the two holes where the original jumper went. Pass the wires under the RF shield (if your Wolfbug hardware is installed there).

4) Identify the wire going to the right-hand hole in Figure 1. That is the wire that connects to pin 1 of the 74LS10. Solder the free end of the wire to the center contact of a miniature single-pole, double-throw toggle switch (such as Radio Shack 275-613). Solder the free end of the other wire to either of the outside switch contacts.

5) Solder another 8" piece of wire to the remaining outside contact of the switch. Solder the free end to a convenient ground point, such as TP3 or TP4 (for "E" boards and earlier), or TP2 or TP8 (for the newest board revision). The final connections should appear as in Figure 2.

If you'd rather not saw on your cover (and remove the label on the channel switch in the process) you can drill a hole for the Wolfbug switch in the top cover at any free spot that the wires will reach, and mount the switch right in the cover. If you do it that way, just be sure not to forget it's there and break off the wires the next time you pull off the cover.

Label the switch function, using a small stick-on label applied to the case next to the switch. Most toggle switches connect the center contact to the outside contact that is opposite the handle. Turn on the computer and see in which position the command EXEC 64000 brings up Wolfbug; label that position "WOLFBUG ON." If the machine crashes, turn it off and label that position of the switch "WOLFBUG OFF."

Now, when you get ready to run OS-9, just check the position of the switch before booting. When you want to use Wolfbug in non OS-9 applications, it'll be available just by reversing the switch.



## KISSABLE OS-9

# Point, Counterpoint, Terminal Problems And A Technical Potpourri

By Dale L. Puckett  
Rainbow Contributing Editor

**T**andy's OS-9 for the 64K CoCo hit the shelves in early November. The phone calls and letters, filled with questions and signs of frustration, started coming soon thereafter.

I got my first look at a production copy of OS-9 at a Radio Shack store in Elizabeth City, N.C. I had a few free minutes one evening while in town attending a week-long pollution response course presented by the U.S. Coast Guard Atlantic Strike Team. I was very impressed with Tandy's professional packaging and the quality of the documentation. Yet OS-9 is so complex and powerful that it's going to take everyone some time to learn the ropes. That's the bottom line.

I remember the first month I used OS-9 — I really stumbled around. I had used FLEX for three or four years, but OS-9 was a whole new ball game. I didn't understand what was happening. The error messages didn't make any sense. But in a week or two, things began to clear up and I've never gone back. Soon, I found myself taking the multi-tasking; the handy "hierarchical directories; the fast random-access files; the type ahead buffer; the "pipes" and the rest of OS-9's friendly environment for granted.

We're going to take a different approach to *KISSable OS-9* this month. We'll answer as many of your questions as possible and try to help you pass through the early part of the learning curve. First, though, I want to clarify my philosophy to my readers and the fine group of programmers and software distributors that are working their tails off to bring professional software to the Color Computer.

---

*(Dale L. Puckett is a freelance writer and programmer who has worked with the Motorola family of microprocessors since 1976. He just completed his first book, "A Complete Tour Guide to BASIC09," this summer. It is being published by Microware and will be available this fall. He is the author of DynaSpell, Readtest, Esther and Help, which are available from Frank Hogg Laboratories. He serves on the Info World Software Review Board and is a Chief Warrant Officer in the U.S. Coast Guard.)*

Michael R. LeVasseur of St. Petersburg, Fla., brought up a point: "Please limit yourself to the properties of this remarkable operating system. Let the software reviewers and Frank Hogg's advertising dollar take up the new software issue."

Counterpoint: Sorry, Mike. I don't agree. It is not enough to let my readers depend on advertising copy to figure out what new OS-9 software products do or how they work. Advertising is designed to do only one thing — get your attention. It is also very one-sided. Only the good points are mentioned. It seldom explains what a product does and almost never tells how it works or what it can really do for you. Unless a reader really knows and understands software, he is making a long leap of faith when he buys most new packages.

Further, I feel the high resolution display described last month is a major product. It makes OS-9 a usable and viable package. Frankly, it should have been a part of OS-9 itself.

Motorola's 6809 microprocessor is the best eight-bit processor on the market. You won't find many programmers or engineers that will argue with that fact. Yet, because of a lack of standardization and cooperation between vendors in the past, it never became a strong force in the personal computing marketplace. With Tandy's selection of OS-9 as the operating system for the Color Computer, we now have a standard and another chance to become a viable force. I intend to help the 6809 make it this time by explaining every major product in enough detail that my readers will know what it is and what it will do for them.

In fact, here's an invitation to all software developers. If you're developing a new product for Color Computer OS-9, drop me a line. Put us in your rumor loop and we'll help you spread the word. When you have the product ready to go, let us try it and we'll do a play-by-play similar to the article on Hi-Res in December. A lot of packages never get off the ground because they're never explained. We'll do our part to solve that problem with *KISSable OS-9*.

## Now What?

LeVasseur also noted that another magazine had said that Tandy's OS-9 documentation was well written and easy to understand. Then he added: "Perhaps so, but I would like to do something more interesting than *BUILDing* files, dis-

playing *DIR* and *MAKDIR*. (Why would I want to *MAKDIR* anyway?) A similar comment came from Bob Dooman of Glenview, Ill. "Okay, I have OS-9, and I understand the 'basic' commands. . . . Now what?"

Let's recap a few of the points I made in my first *KISSable OS-9* column. OS-9 is a tool. And as with any tool, you must learn the basics before you achieve productivity. Before a baby walks, it crawls. Another good analogy is the coach that holds blocking and tackling drills for a month before he puts the first play on the chalkboard.

Each utility program in your OS-9 CMDS directory is a tool and most of them work on files. Before you can work on files, they must exist. *BUILD* is nothing more than a handy utility that makes it easy for you to put small files on a disk so you can use them in the future.

These files may take the form of simple text which you will list to your screen later when you need a reminder. Or, they may be "procedure" files that automatically run your CoCo through a series of small programs that together do a big job. In any case, before you can use them, you must get them on the disk. Hence, *BUILD*.

For larger files you will want to use a larger editor to enter your text or procedures. Microware's *EDIT*, which comes on your OS-9 system disk, is an excellent line editor. If you prefer a screen oriented editor, *DynaStar* is excellent.

*DIR* is also a necessary evil. Granted, you can print the names of your files if you only have one or two on a disk. But, what happens when you have a dozen? And even if you do remember their names, can you remember how you spelled them when you made up the filenames?

Now, let's justify *MAKDIR*. Remember what it was like when you were running Radio Shack's Extended Disk BASIC? Everytime you typed *DIR*, the names went by on the screen like a fast freight. If you had nimble fingers, you could stop the listing with the [SHIFT][@] combination. It never worked for me. Every time I tried it, the listing would stop just after the name I needed scrolled off the top of the screen.

Even FLEX's *CAT* or *DIR* commands could be a problem. FLEX is a great operating system and it has a feature which causes the scrolling to stop each time the screen fills with text. But did you ever do a *CAT* on an eight-inch disk with 500 files? There must be at least 50 filenames that start with every letter in the alphabet on every one of my drives. It takes a lot of time to look at them all, just to find the command or text file you want.

Enter OS-9's "hierarchical" file structure. Let's use another analogy. How is your office set up? In most businesses, each person has a desk and an individual file cabinet. That cabinet is divided into drawers which contain information relevant to a specific part of that person's job.

Now, let's automate the office. We'll use a microcomputer with an operating system that lets several people work on different terminals at the same time. That sounds like OS-9.

If we were using an operating system like Disk Extended BASIC, everyone's files would be in the same directory — the same file cabinet so to speak. If a secretary needed to find a file for her boss, she would have to look through every file on the hard disk. It would be like looking through every drawer in a large file cabinet. It would take her a long time. The boss would get angry.

OS-9 solves this problem by letting you use multiple directories. Let's go back to the same office and show that the same hard disk would look like if it were running under OS-9.

For starters, it would have a device name, probably "/H0." When the secretary does a *DIR* of the drive it probably looks something like this:

```
DIRECTORY OF 12:32:30
OS9Boot   CMDS      SYS       DEFS
Startup   Read.This BOSS      SECRETARY
SAM       JOE       SALLY     JANE
```

If she did a *DIR* with the "e" option she would notice that each of the filenames above that were printed on the screen with all capital letters had a "d" printed in the Attributes column. This means it is a directory. Typing directory names in all capital letters is one habit you'll want to pick up early in your OS-9 career. It'll save you from losing your hair with a lot of head scratching.

Now, let's suppose that the file the boss wanted to see was a letter that Sally had sent to the company's ad agency last week. Our trusty secretary could then type:

```
OS9: chd . ./SALLY
OS9: dir
```

At this point, she might see something like this:

```
DIRECTORY OF 12:32:45
ADVERTISING NEWSLETTER      PAYROLL
SCHEDULES  ACCOUNTS.PAYABLE
```

Since she knows that each of the filenames listed are directories she then types:

```
OS9: dir advertising
```

She may see something like:

```
DIRECTORY OF advertising 12:33:02
COPY      IDEAS      Agency.Letter
Instructions
```

Now, she can type:

```
OS9: list advertising/ Agency.Letter >/p
```

You have just seen how easy it is to find a file when it has been stored in a logical place. Our secretary knew that Sally wrote the letter so she looked in Sally's directory. Since she knew it was to an advertising agency, she looked in Sally's advertising directory. She had the boss' answer in seconds. Looking through hundreds of filenames on a single hard disk directory would have wasted a lot of time. That is why you "would ever want to *MAKDIR*."

### Now What, Continued

Now, let's tackle Bob's question. First, we must understand that OS-9 itself is only an operating system. It is not an application package or a language used to write programs. It is, rather, an environment that provides a home for your languages and applications. As we stated in December, it was written to provide the support necessary for BASIC09, a state of the art language designed by Microware and Motorola.

Yet, OS-9 comes with nearly 50 utility programs that can do many jobs for you. With the addition of a toolbox like the one library of file handlers sold by Microware, you can do many jobs right from the OS-9 command line. We gave you a few examples in our January column. Here's another example of what you can do with an understanding of this operating system and a little imagination.

How many times have you wanted a simple database *manager* that would let you look up a phone number fast? Try this:

```
OS9: BUILD phone
? ken kaplan, 515-555-1212, des moines, ia
? lonnie falk, 502-228-4492, prospect, ky
? jim reed, 502-228-4492, prospect, ky ?
```

This sequence of lines uses the *BUILD* utility to place three names with the proper telephone number, city and state, in an OS-9 text file. Of course, you could put hundreds of names and numbers in a file with one of the larger editors.

Now, suppose that you are on the phone and someone asks you for Lonnie's number. Your desk is a foot high in little yellow telephone slips and someone has taken his card from your card file index. What can you do? If you have a CoCo running OS-9 on your desk and have installed one of the UNIX like toolboxes, you can simply type:

```
OS9: grep Lonnie phone
```

In a second or two this line will appear on your screen:

```
lonnie falk, 502-228-4492, prospect, ky
```

Let's give another example. What can you do if you remember a long lost friend in Kentucky that used to talk to you on the ham radio bands, but you can't remember his name? Try this:

```
OS9: grep ky phone
```

Seconds later you'll see this message on your screen.

```
lonnie falk, 502-228-4492, prospect, ky
jim reed, 502-228-4492, prospect, ky
```

How's that for an easy and cheap electronic phone book?

### Terminal Problems

The one problem that has prompted more calls than any other has surfaced when readers have attempted to hook up an external terminal to CoCo's RS-232 connector and use it as device, /T1.

I tried it last August when I first installed OS-9 on my computer and it seemed to work. But, since I was receiving so many calls, I thought I better check it out again. So this weekend, I tried it again, twice.

The first time I used my GIMIX computer running a mode program as a terminal for the CoCo. Talk about

overkill. When it didn't seem to be as reliable as I thought necessary, I decided to hook the Televideo Model 925 up directly to CoCo. I wanted to be certain that I did not have a problem with my modem program or with the configuration of the ACIAs on the GIMIX.

After a quick trip to the local Radio Shack for a DB-25 RS-232 connector for the Televideo, I made a cable and tried again. Same results.

At this time, I started to experiment with Baud rates. It turns out that device /T1 in CoCo OS-9 is almost reliable at 600 Baud. If you try to run it at 1200 Baud, it will not work at all. The 300 Baud position seems to be solid, albeit painfully slow.

Unfortunately, it seems that if you want to run an external terminal, you must use a transmission rate no higher than a 300 Baud. Also, I noticed that it is impossible to halt a listing on the external terminal. The wait, interrupt and abort keys simply do not work. All of these problems are caused by the "bit banging" routines that try to make a PIA look like an ACIA to the outside world. Hopefully, the new RS-232 cord that is designed to plug in the new expander interface contains a real ACIA. If so, it will be easy to write a device descriptor and device drivers to use it.

### A Higher Stepping Rate Boot

We promised to give you this information last month but somehow it managed to slip through the cracks. Before we start though, we should clear up a related question for J. Frank Fields of Bethany, Okla. The typesetting machine moved two periods too close together and threw him a curve. He writes: "I couldn't follow your directions after DB: L CCDIS. I had to use DB: .BE00+204 or single step to the location, otherwise all was very successful."

Here's what the sequence should look like:

```
OS9: debug
INTERACTIVE DEBUGGER
DB: I ccdisk
    BE00 87
DB: . [SPACE] .+204
    C004 22
DB: =08
    C005 2E
DB: =8B
    C006 30
DB:
```

The "I ccdisk" tells DEBUG that you want it to link to

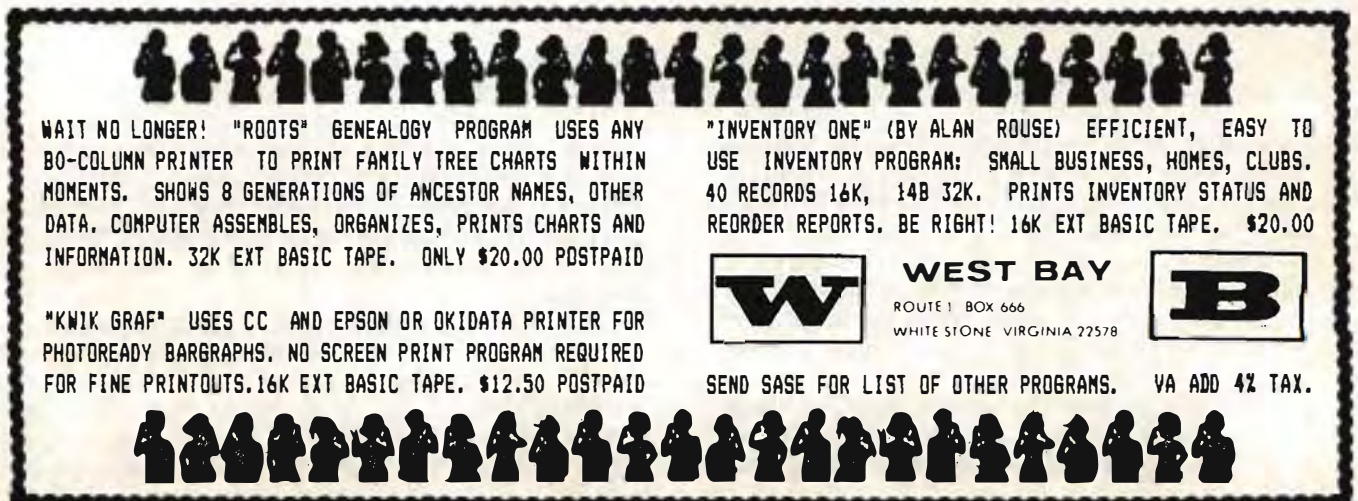

WAIT NO LONGER! "ROOTS" GENEALOGY PROGRAM USES ANY 80-COLUMN PRINTER TO PRINT FAMILY TREE CHARTS WITHIN MOMENTS. SHOWS 8 GENERATIONS OF ANCESTOR NAMES, OTHER DATA. COMPUTER ASSEMBLES, ORGANIZES, PRINTS CHARTS AND INFORMATION. 32K EXT BASIC TAPE. ONLY \$20.00 POSTPAID

"KWIK GRAF" USES CC AND EPSON OR OKIDATA PRINTER FOR PHOTOREADY BARGRAPHS. NO SCREEN PRINT PROGRAM REQUIRED FOR FINE PRINTOUTS. 16K EXT BASIC TAPE. \$12.50 POSTPAID

"INVENTORY ONE" (BY ALAN ROUSE) EFFICIENT, EASY TO USE INVENTORY PROGRAM: SMALL BUSINESS, HOMES, CLUBS. 40 RECORDS 16K, 14B 32K. PRINTS INVENTORY STATUS AND REORDER REPORTS. BE RIGHT! 16K EXT BASIC TAPE. \$20.00

**W** **WEST BAY** **B**  
ROUTE 1 BOX 666  
WHITE STONE VIRGINIA 22578

SEND SASE FOR LIST OF OTHER PROGRAMS. VA ADD 4% TAX.

**WICO "BAT" JOYSTICK TRIO**  
2 bat & adaptor  
SALE \$63.88

**POINTMASTER JOYSTICK TRIO**  
2 pointmaster & adaptor  
SALE \$45.81

**CHAMP JOYSTICK TRIO**  
2 champ & adaptor  
SALE \$47.81

**WICO "BOSS" JOYSTICK TRIO**  
2 boss & adaptor  
SALE \$55.88

**MIX MATCH TRIO**  
2 JOYSTICKS & ADAPTOR  
SALE \$55.00

**QUICKSHOT JOYSTICK TRIO**  
2 quickshot & adaptor  
SALE \$47.81

Unmatched accuracy, 2nd only to the RED BALL  
RETAIL \$79.85

\* 1 wico & 1 other joystick with adaptor

**DONKEY KING** — (Donkey Kong) The best graphics and sound ever on the coin-operated "test action" 32K \$24.95

**CUBER** — (Cuber) Jump from cube to cube and change the color as you see them. The winner chooses who wins you. 32K \$21.95

**ELECTRON** — (Iron) Four games in one! Eight from which to choose, and four the other. 16K \$24.95

**SPACE SHUTTLE** — A simulation of space shuttle launch. From blast off to a smooth landing it's a winner. 32K 60K \$28.95

**TRAPBALL** — (Pitfall) Hidden treasures, only level the dirt, falling on the wire, watch out! 16K \$22.95

**THE FROG** — (Frogger) Cross the busy highway to the safety of the median and then on past the oncoming traffic hazards. 16K \$24.95

**MOON SHUTTLE** — Fight your way through the asteroid fields and past the moon. 16K \$28.95

**M TOM MIX**

**Datagsoft Inc.®**  
ALL ARCADE GAMES OFFICIAL VERSIONS.

**WICO TRACK BALL**  
YOU CONTROL THE SPEED AND THE 360 DEGREE MOVEMENT IN THE PALM OF YOUR HAND - LIGHT YEARS AHEAD OF ANYTHING ON THE MARKET.  
RETAIL 89.95

**WICO ANALOG JOYSTICK**  
BIGGER AND STRONGER THAN EVER! A HANDLE YOU CAN SET TO CENTER, AUTOMATICALLY OR FLOAT FREE. ENGINEERED TO BE THE BEST!  
RETAIL 49.95

**RAINBOW CERTIFICATION SEAL**

**WHAT DID YOU SAY!**  
LUNAR LANDER WORKS WITH SPECTRUM PROJECT'S VOICE PAK

**LUNAR LANDER**  
Land your damaged Lander on one of 4 different planets.  
16K EXT \$15.95

**STAR RAID**  
Dock with your base station to fuel up and fight the attacking aliens.  
\$18.95

**DEATH STAR**  
Use the force and save the princess.  
(Review in April's Rainbow) 32K EXT \$19.95

**ALL SHELL 16K GAMES HAVE 32K VERSIONS (75% ML) BOTH VERSIONS ARE INCLUDED.**

**ENTERMINATOR**  
With your own hand you fight back the alien attack.  
16K EXT \$18.95

**ML AUTHORS TOP ROYALTIES PAID**

**SONAR SEARCH**  
Using sonar and depth charges find and destroy enemy ships. 16K EXT Review Nov \$18.95

**SHELL Software Also Available On DISK!**

**FERERATION BOOT CAMP** 16K EXT  
You've been drafted for 16 wks. Four games in one can you hack it? \$18.95 ©

**SNOOPY & THE RED BARRON**  
A hi-res graphic "Dog fight". See Review Jan. 16K EXT \$18.95 ©



USA Orders under \$50 - Add \$2.50  
OTHER Orders Add \$5.00 ship/hnd.  
Fla. Residents add 5% sales tax.  
Visa/MC Add 5%  
**NO C.O.D. ORDERS**

8301 Sarnow Dr./Orlando, FL 32807

**ORDER LINE 10 AM TO 9 PM** 1(305) 262-8907  
**SOFTWARE AUTHORS AFTER 6 PM** 1(305) 275-8490

**ML AUTHORS, TOP ROYALTIES PAID!**  
**15% DISCOUNT**  
on all software, mention this ad  
free 16K Adv. with \$50.00 order

that module, BE00, and the value of the byte stored there, 87. Your next line tells DEBUG that you want to add 204 hexadecimal to your present location (BE00). It does this and returns a value of hexadecimal C004. This is where one of the magic mystery bytes that changes the drive stepping rate is located. Actually, the value you changed above is the value of a constant used in a delay loop.

Frank found another typo on Page 163 of the OS-9 Program Development booklet. So you won't have the same problem, here is the correct sequence:

```
OS9: cobbler /d1
OS9: verify </da/os9boot >/d0/temp u
OS9: del /d1/os9boot
OS9: copy /d0/temp /d1/os9boot
```

To make a disk that with the higher stepping rates that will boot, perform the following patches using DEBUG:

```
OS9: debug
INTERACTIVE DEBUGGER
DB: l boot
FD74 87
DB: . [SPACE] .+A9
FE1D 43
DB: =41
FE1E 34
```

After you have patched the byte above, link to the boot module again, ie, l boot, and make the following changes:

OFFSET	OLD	NEW
B5	03	01
154	13	11
15A-15B	222E	082B

Note that each of the offsets above is from the start of the module and is found by using DEBUG's "l" command.

After you have made the changes you must save the new boot module to a disk file:

```
OS9: save /d1/tempboot boot
```

Then, you must verify the disk file you have just saved to find the proper CRC for the file:

```
OS9: verify </d1/tempboot >/d1/updated.tempboot u
```

Now, the CRC bytes in the file /d1/updated.tempboot will be correct. Examine them with *IDENT* or use *DUMP* to list them to the screen and write them down. Then, use *DEBUG* to change the CRC bytes in the "boot" module that you changed in memory. The CRC bytes in memory **MUST** agree with the CRC bytes in the verified file, "updated.tempboot." The CRC bytes are the last three bytes in the module. After you make this modification, you can use *COBBLER* or *OS9GEN* to make a new boot disk. Don't forget to save the changes you made last month in the *CCDIS* module.

### Faster Speeds And 40 Tracks, Too!

J. Frank Fields also asked how to set up CoCo OS-9 to use his 40-track drives.

This modification is made in the device descriptor module. /D0 and /D1 are both device descriptors. Hence, if you have 40-track drives installed as both devices you must change both drive descriptors. Here's the sequence:

```
OS9: debug
DB: l d0
```

```
C10B 87
DB: . [SPACE] .+I8
C123 23
DB: =28
C124 01
DB: q
```

After you change this byte in the device descriptor /d0, OS-9 will know that you have 40 tracks available on that device. Repeat the sequence of steps above on the device descriptor /d1.

Once you have changed the device descriptor, you may use the *COBBLER* command to create a disk that will come on line with 40-track drives for /d0 and /d1.

After you make this modification, OS-9 will still read and write to disks that were formatted earlier with 35 tracks. You must format a new disk using the format utility — after you have made this change to the device descriptor (/D0 or /D1) — before you can actually use 40 tracks.

### A BASIC09 Tip

My sources tell me that BASIC09 is now (December 1) on the shelves. I have also confirmed through a second source that Microware's C is hot on its heels. Tandy should have it soon after you read this. You're going to love the day you bought your CoCo.

Since BASIC09 is on the air, next month we'll try for an in-depth intro of this fascinating language.

Should you type your BASIC09 programs using uppercase letters? Or would lowercase letters look better?

Most programmers will agree that BASIC programs look nicer and are easier to understand when BASIC keywords are typed in uppercase letters and variable names are typed with lowercase letters. With many languages, this is quite a hassle. It's a snap with BASIC09.

Here's how to go about it. When you type a procedure, leave your keyboard in the lowercase mode and only use the shift key when you want your procedure to print a capital letter. BASIC09's built-in editor will do the rest. When you list the program you'll be in for a nice surprise.

In fact, you'll see that BASIC09 does more than capitalize keywords. It also automatically indents listings. This makes procedures easier to read and will help you find certain logical errors.

Here's an example. If you type:

```
for count := first to last
print count
```

BASIC09 will list it like this:

```
FOR count := first TO last
PRINT count
NEXT count
```

We'll try to pass along little hints like this on a regular basis as part of *KISSable OS-9*.

In closing, I would like to correct a false impression stated by Shneur Z. Sherman of Davis, Calif. He wrote to ask why anyone would want to run OS-9 and BASIC09 since BASIC09 doesn't have any graphics capability.

Far from true, Shneur. With OS-9, even the operating system has graphics capabilities. It would be a very easy matter to *BUILD* a procedure file using the *DISPLAY* utility and produce all kinds of attractive graphics on CoCo's screen. Maybe we'll try that next month! Till then!



# Color by HOT CoCo



If you like color . . . you're going to *love* HOT CoCo magazine.

The exciting new monthly devoted exclusively to the TRS-80 Color Computer.\* It's from the publisher of 80 Micro.

Let **HOT CoCo** color *your* system with:

- Feature articles on color graphic techniques
- Computer art
- Games
- Specific color applications in home, education, business and hobbies

PLUS

- Ideas on patching, aiding and trouble shooting
- Buyer's guides
- Product and book reviews
- Hardware interfacing and enhancing
- Programming techniques and tutorials

Best of all, **HOT CoCo** is written by users just like you.

The material is always up-to-date and useful. Hardware, software, books . . . what's new . . . what's best . . . what works. And you get one year for only \$24.97. A 13th issue is yours **FREE** with pre-payment (check or credit card). Use the attached order form, the coupon, or call toll free 1-800-258-5473. Subscribe Today!

**YES!** please sign me up for one year of HOT CoCo at \$24.97. \*\* I understand that with payment enclosed or credit card order I will receive a free issue making a total of 13 issues for \$24.97.

MC  VISA  AE  CHECK/MO  BILL ME

Card# \_\_\_\_\_ Exp. Date \_\_\_\_\_

Signature \_\_\_\_\_ Interbank # \_\_\_\_\_

Name \_\_\_\_\_

Address \_\_\_\_\_

City \_\_\_\_\_ State \_\_\_\_\_ Zip \_\_\_\_\_

Canada & Mexico \$27.97/1 yr. only, US Funds  
Foreign surface \$44.97/1 yr. only, US Funds drawn on US bank.  
Please allow 6-8 weeks for delivery.

**739FRB**

**HOT CoCo • PO Box 975 • Farmingdale NY 11737**

\*TRS-80 Color Computer is a trademark of Radio Shack, a division of Tandy Corp.  
\*\*This price voids all previous offers.

**HOT CoCo**

## Trouble Shooter Makes Program Pak Connection

By Tony DiStefano  
*Rainbow* Contributing Editor

I would like to get right into business this month. The first thing I want to discuss is about telephone calls. I was good enough to give out my number to those people who had problems with my projects or want to express an idea or opinion and I think that it is great that I got a lot of response; but please limit your calls to Monday nights only! For those of you who do not have my number and those of you that just started getting *the Rainbow*, my number again is (514) 473-4910. Call only after 7 p.m. EST and not too late. I am an early riser!

Okay, now back to the order of the day (month?). One of the best things to come out of these phone calls is that people can point out errors in my articles. (Yes, I do make mistakes. You should see my replacement-parts bills.) The faster I know about the mistakes, the faster I can write a fix for them. The main reason for the mistakes or errors is the transfer of information from my proto-board to you, *the Rainbow* reader. All of my projects are tried and tested before I write them in here. If a project that you put together does not work, check your work carefully. If it still doesn't work, call me and I'll give you a fix. If I can't give you a fix on the spot, I'll write one up in the following article. Speaking about fixes, here is one.

There is a problem with my internal speaker/amplifier project. The capacitor marked C-2 in the parts list is wrong. It is not a .022 uf capacitor. It should be a .002 uf capacitor. Also, the part number for the LM-380 (IC-1) is not 276-076 like it says in the article, but 276-706. Sometimes my fingers get carried away. The last thing to mention is a misprint in Figure 1. The little scribble to the right of C-2 should read "6." That is pin #6 of the IC. I would like to thank Hilton Wasserman for pointing this out to me. For your interest, the schematics in "Turn of the Screw" are drawn with the help of my Color Computer and an EPSON printer. I use the program *Schematic Drafting Processor*, currently being distributed by Spectrum Projects. See the ad in this magazine.

I received a letter from Kyle Rogers this month, this is a part of it; "... I enjoy reading 'Turn of the Screw,' and I would like to build many, if not all, of the projects presented. But I find that I have neither the tools, skills, nor the time to construct the devices. Many hardware columns in other magazines have alleviated this problem by making an

*(Tony DiStefano is well known as an early specialist in Color Computer hardware projects. He is one of the acknowledged experts on the "insides" of CoCo.)*

agreement with an outside company for that company to manufacture and market pre-assembled versions of the projects presented in that magazine. . . ." Can anyone help? Please contact me through *the Rainbow*.

The remainder of this article will be in answer to Tewfick Chidiac's question, "What do all the pins in the Program Pak connector, on the side of the computer, connect to, anyway?" Okay, Tewf, here is a detailed description of the Program Pak connector.

First of all, the main use for this connector is to plug in (you guessed it), Program Paks. These are little plastic cases that contain a small PCB (Printed Circuit Board). On this PCB there is usually one or more ROMs (Read Only Memory). This is where the game or utility software is stored. Other examples of different types of Paks are; disk controllers, RAM (Random Access Memory) boards, printer ports, I/O (Input/Output) boards, serial communications boards and so on. They all have one thing in common. They access the "bus." A bus is a term used to represent common wiring that connect to many components. Having access to the bus lets you expand the capabilities of your computer. The bus in the Color Computer fall into three main categories; data lines, address lines and control lines. Our computer has eight data lines, it is known as an 8-bit data bus. It also has 16 address lines and several control lines. The following is a list of all the lines (or pins) that come out of the connector.

### Color Computer Bus Descriptions

PIN#	Function	Description	Direction
1	-12v	-12 Volts	Output
2	+12v	+12 Volts	Output
3	HALT	Halt line to CPU	Input
4	NMI	Non Maskable Interrupt	Input
5	RESET	Resets the computer	Input
6	E	Main clock signal	Output
7	Q	Secondary clock signal	Output
8	CART	Cartridge detect signal	Input
9	+5v	+5 Volts	Output
10	D0	CPU Data line #0	I/O
11	D1	CPU Data line #1	I/O
12	D2	CPU Data line #2	I/O
13	D3	CPU Data line #3	I/O
14	D4	CPU Data line #4	I/O
15	D5	CPU Data line #5	I/O
16	D6	CPU Data line #6	I/O
17	D7	CPU Data line #7	I/O

18	<u>R/W</u>	Read/Write signal	Output
19	A0	CPU Address line #0	Output
20	A1	CPU Address line #1	Output
21	A2	CPU Address line #2	Output
22	A3	CPU Address line #3	Output
23	A4	CPU Address line #4	Output
24	A5	CPU Address line #5	Output
25	A6	CPU Address line #6	Output
26	A7	CPU Address line #7	Output
27	A8	CPU Address line #8	Output
28	A9	CPU Address line #9	Output
29	A10	CPU Address line #10	Output
30	A11	CPU Address line #11	Output
31	A12	CPU Address line #12	Output
32	<u>CTS</u>	Cartridge Select signal	Input
33	GND	Ground Return	Input
34	GND	Ground Return	Input
35	<u>SND</u>	Sound Input	Input
36	<u>SCS</u>	Spare Select signal	Output
37	A13	CPU Address line #13	Output
38	A14	CPU Address line #14	Output
39	A15	CPU Address line #15	Output
40	SLENB	Device Disable	Input

I shall describe each pin in detail and where it connects to inside the computer. 1) This output pin comes from the power supply. It supplies -12 Volts to any component, maximum drain is 100 ma (miliamps). 2) This output pin also comes from the power supply. It supplies +12 Volts and has a maximum of 300 ma. 3) The Halt line is an input line that goes directly to the CPU. It is tied to normally HI (+5v), by a resistor of 4.7k ohms. When this pin goes low, the CPU completes its last instruction and goes into the tri-state mode. Tri-state means that all of the CPU bus lines are high impedance, They are neither HI nor LOW. It is as if nothing was connected to it. 4) The NMI input line goes directly to the CPU. It is also tied HI. When this line goes low, the CPU performs a non-maskable interrupt. That means that the CPU will jump to a predetermined address and continue to execute this code until it reaches an RTI (Return from Interrupt), in which case it will continue doing what it was doing before the NMI line went low. 5) The RESET line connects to the CPU and all the man chips that have reset lines. All except the VDG chip. That is only controlled by the external [RESET] switch in the back of the computer. The function of the RESET line is to initialize all the components to powerup conditions. Under software control, if the value in byte # \$71 (113) is not equal to \$55 (\$ denotes Hex), the computer will do a cold start. If it is, it will attempt

to do a arm start. This line is also tied HI, but ith a 100k ohm resistor. 6) The E clock is the main timing for the CPU. The E clock is generated by the SAM (Synchronous Address Multiplexer) and goes into the CPU and nto the bus. 7) The Q clock is the secondary clock. It is also generated by the SAM. The Q clock leads the E clock by 90 degrees. 8) This input goes into one of the PIAs (Peripheral Interface Adapter). It is tied HI with a 10k ohm resistor. The function of this line is to detect the presence of a Program-Pak and to jump to it. 9) This output pin comes from the power supply. It supplies +5 volts to any component with a maximum of 300ma. 10-17) These eight DATA pins provide bi-directional communications between the CPU and the system. They connect directy to the CPU and all other data related chips. 18) The Read/Write line is an output which tells all data related chips which direction the data lines of the CPU are in. 19-31 and 37-39) These 16 pins address lines come from the CPU and tell all other data related chips, where in memory the CPU wants to Read or Write. 32) This output is a chip select. It comes from pin #12 of the 74LS138. It is memory mapped to select memory between \$C000 (49152) and \$FEFF (65279). This is a 16K block of memory known as the cartridge memory or the Color Disk BASIC ROM area if you have a disk drive plugged in. The pin is active LOW, which mans that the meory chips associated with this pin will respond when it is low. 33-34) These two pins are ground returns. All signals are returned to the system through them. 35) This input is connected directy to the sound multiplexor (MC14529b) pin #12. With this pin, sounds in the audio range can be output to the TV speaker. 36) This output is another chip select. It comes from pin #9 of the 75LS138. It is memory mapped to select memory between \$FF40 (65344) and \$FF5F (65375). This is a 32 byte long block of memory mainly used for external I/O for such devices as a disk controller or PIAs. The pin is active LOW, which means that the I/O devices associated with this pin will respond when it is low. 40) This input is connected to pin 6 of the 74LS138. This active LOW pin disables the internal device selection. This allows decoded but unused sections of memory to be used by the cartridge hardware.

Now that you know all about the cartridge connector, go out and experiment but be careful, CPUs and SAMs are quite expensive.

#### References:

RadioShack Color Computer Technical Reference Manual  
 Motorola Microprocessors Data Manual.  
 Artwick Microcomputer Interfacing

## SHAMROCK SOFTWARE PRESENTS

**WORD SEARCH PUZZLE MAKER WITH DEFINITIONS** - Enter a word and its definition. The puzzle contains the words, but only prints out the definition. In order to solve the puzzle, the correct words for the definitions given must be determined. **\$9.95**

**VOLUME WORKSHEET MAKER** - Prints out worksheets containing problems in changing from one volume measurement to a different volume measurement and/or finding the volume of common geometric solids. **\$9.95**

16K EXT. COLOR BASIC & PRINTER REQUIRED - OTHER WORKSHEET MAKERS AVAILABLE - OHIO RES. ADD 5.5% SALES TAX

SHAMROCK SOFTWARE 4382 NORTON ROAD RADNOR, OHIO 43066 614-494-2277

## THE ADVANCED OPERATOR

## For The CPU Of Choice: Go CoCo

By Frank Hogg

*This is the first installment of a column by the head of Frank Hogg Laboratory on advanced operating systems, including FLEX, OS-9 and matters of your choice. You may*

*mail requests for topics to The Advanced Operator, Frank Hogg Laboratory, The Regency Tower, Suite 215, 770 James St., Syracuse, N.Y. 13203*

What is an *Advanced Operating System*? Before I get into what an advanced operating system is, I have to give you some history so that you have a point of reference. Hang on, this won't be *that* boring. I first became involved with micros in early 1977. My first computer was called a "KIM 1." It had all of 1K of RAM and a 2K ROM monitor. It cost more than the 16K CoCo costs now. The only "mass" storage was a slow 300 Baud cassette — the CoCo is 1200 Baud — and the display was a six segment LED display.

After about six months I was able to get a deal on a TTY and move up in the world. Now, I not only had a terminal with real keys, I also had hard copy output. It ran at a fearsome speed of 110 Baud, that's 10 characters per second, or about as fast as you can type. Pretty bad, but remember that was 1977. The KIM had a 6502, just like the Apple and Commodore, but there was no software available for it and I became restless for something more.

I picked up a used SWTPC 6800 computer. This was originally a kit, and the company is still in business today. As a matter of fact, I think it is the oldest microcomputer company still in business. The SWTPC is a SS50 bus computer, you probably have seen the ads for GIMIX, a well known SS50 manufacturer. Well, this is what I had as my second computer. It didn't have an operating system because it didn't have a disk, but luckily after three or four months I was able to scrape together the thousand dollars I needed for a five inch disk system. This system had two five-inch *single-sided single* density drives with 340 sectors of storage each! It doesn't seem like much now, but remember, back then things were much different. Besides, we didn't have much to put on the disks anyway!

We finally get to an operating system. The SWTPC had what can only be called a primitive operating system. It did little more than save and retrieve information from the disk. It was not even as sophisticated as RS DOS. You had to think of the disk as a tape and take care of most of the details yourself. This meant that you, as the programmer, were responsible for all the things that today's advanced operating systems take care of for you. When you think about it for a while, you can come to the conclusion that after all, this *is* a computer and the software in *it should do the work, not you.*

Pretend that you had a computer that you could say the following to:

"Computer, when is my next appointment?"

*(Frank Hogg is the president of Frank Hogg Laboratory, one of the world's largest suppliers of software for 6809 based computers. He and his wife, Linda, live in Syracuse, New York.)*

and the computer would respond. Well, we haven't reached that stage yet, but advanced operating systems try to lessen the need for you to have to deal with your computer at a low level. The more sophisticated an operating system is, the better job it will do. There are problems with this though; the main one being that operating systems are developed before applications can be developed to run with them. The same is true for the hardware they run on. The evolution is this: first, the computer is created, then the operating system, and finally the applications software. By the time a sufficient amount of software becomes available for a particular computer, the computer itself is obsolete. This is the case for the Apple. It has a lot of software available for it, but the design dates back seven years — to the dark ages.

Of all the 8-bit processors on the market today the 6809 is the most recent state of the art. It is at year three or so in its development, and the amount of software available for it has reached a volume where it is now a practical CPU to work with. The fact that it is the best 8-bit CPU, and better than most 16-bit CPUs, doesn't hurt any either. The 6809 is the CPU of choice to buy today. It just happens to be the one in the CoCo, GIMIX and several other state of the art computers available today.

The world is full of "Band wagon followers." If you read anything today about computers you will undoubtedly come away with the feeling that if you don't own an IBM or a "compatible" computer, then you are not with it. People are buying on image, not performance in that area, or they are buying VIC-20s because of price rather than performance. Here are some facts for you to digest. The CoCo running FLEX and TSC Xbasic is three, that's *three*, times FASTER than an IBM PC! These timings are from a benchmark that appeared in *Interface Age* about one and a half years ago. The CoCo is not only the fastest micro around, but the quality of operating system software, both in FLEX and OS-9, is *far* superior to anything available for any other 8-bit system.

Think of this for a moment. What computer under \$3,000 is multiuser and/or multitasking? I can't think of any, but do you know that for under \$1,000, the CoCo with OS-9 *is!* Let me digress for a moment and talk about the importance OS-9 has on education.

Every college of any value has computers that run with UNIX! This means that every student that is going to attend college will have an advantage if they are familiar with UNIX before they begin college. OS-9 is based on the UNIX concept, and the transition from one to the other is very easy. OS-9 is very similar to UNIX, and therefore is ideal for students to work with. As a matter of fact, we are going to market a series of programs based on UNIX utilities to further enhance OS-9 as a UNIX like system.

## THE TANDY SCOREBOARD

When Tandy first came out with the CoCo there were several deficiencies that needed improvement. Some of them have been taken care of and some remain to be fixed. Here is the list to date:

1. Not enough memory. Stage 1
2. Poor keyboard.
3. Poor aesthetics. (Gray case)
4. Insufficient display (16 x 32)
5. Not enough online disk storage.
- 6.. Not enough memory. Stage 2

The display has always been a problem. You simply cannot do much with only 16 x 32. Software packages like O-Pak for OS-9 and several big screen packages enhance the display, but at the cost of memory. What is really needed is a built in display that handles at least 24 x 80.

The RS disk system is only single-sided. This limitation becomes evident with the use of OS-9. The system disk as purchased from Tandy has only 112 sectors free from the 630 that are available on the disk. Although you can up the tracks to 40 if your drives can handle it, a double sided capability is needed, like FLEX and even better, a hard disk system.

When Tandy came out with the 64K CoCo, they took care of the first memory problem. However, OS-9 uses so much memory (capable of using up to one megabyte) that Tandy now needs to add even more memory to make the system truly useful.

Do not despair. Tandy does listen to its customers; the fact that they have upgraded the system so far is indicative of that. So be patient, I am sure that things will improve.

## MORE ROOM

Because the RS OS-9 disk has so much stuff on it there is little left for your own files. Well, there is a way to free up a considerable amount of room. First, you have to determine what your needs are. You probably don't use timesharing so you can remove the files from the /cmds directory that are needed for that. They are *tsmon* and *login*. Other commands that are not used often are *binex*, *cobbler*, *dcheck*, *exbin*, *sleep*, and *tee*. Of course you may have different choices, but you get the idea. For doing assembly work you should make up a separate disk with the appropriate commands and remove them from the system disk. On the disk that is not used for assembly work you do not need the /DEFS directory. If you do not log on your system, and there is no reason to, you do not need the /SYS directory. Basically, you have to make up several "system" disks for each specific task you want to perform.

On the memory side of things, you can free up a few pages by OS9gen'ing a new boot and leave off the modules *pipeman*, *piper* and *pipe*. If you do not timeshare, then you don't need the modules *T1* and *RS232*. Finally, you only need the descriptors for the drives that you have: ie. *d0* and *d1*. This will only save a few pages, but you may need the memory. After all, once you've done it you do not need to do it again.

In order to make this column useful to you, I need input from you, in the form of questions and suggestions, as to what I should cover here. Please send them in care of the magazine.

Coming next month . . . I don't know! So, send in your questions, or you'll be in for as big a surprise as me.

Till then . . .

# Genesis Software

presents

## Arcade Action

### ★ Q\*Man

*This is the challenging one! Fast-paced with hi-res graphics. Jump onto the cubes, ride the spinning discs and avoid nasty characters. Requires joystick and 32K machine language arcade game.*

Tape cassette (postage paid).....\$26.95

**DESIGNER'S CHALLENGE:** The first three players who reach level 9 on Q\*Man will receive \$25 from Genesis Software.

## Adventure

### ★ The Enchanted Forest

*The BIG adventure in hi-res graphics. Move through more than 50 scenes on a quest to rescue the captive princess. Decisions are made according to visual clues, not text. There are many inhabitants in the Enchanted Forest — some are friendly, some are not. This is a sophisticated computer adventure — a real challenge. A must for your adventure library. (Enchanted Forest was reviewed in the Dec. 1982 issue of Rainbow). Requires 32K extended basic.*

Tape cassette (postage paid).....\$21.95

### ★ Secret Of The Crypt

*The BIG adventure continues. The sequel to the popular "Enchanted Forest" is here! You'll move in more than 50 hi-res, 3-D graphic scenes searching for clues in an attempt to enter the crypt. But beware, the trail to the crypt is beset with puzzles. In fact, the crypt's secret will remain a mystery to all but the most adventuresome. Requires 32K extended basic.*

Tape cassette (postage paid).....\$21.95

### ★ Bigfoot

*Hunt Bigfoot in a hidden maze of caverns and twisting tunnels that are displayed in hi-res graphics as you move. Seek out the lair of Bigfoot while avoiding perils along the way. Features multiple levels and many options of play. Each hunt takes place in a new, randomly generated maze. Challenging and fun. (Bigfoot was reviewed in the March 1983 issue of Rainbow). Requires 32K extended basic.*

Tape cassette (postage paid).....\$21.95

## Family Fun

### ★ The Game Show

*Now a lively party game where two teams compete against the clock to name several items in a category. Includes 60 rounds with color graphics and sound. Machine language routine for fast response. (Game Show was reviewed in the Jan. 1983 issue of Rainbow). Requires 16K extended basic and joysticks.*

Tape cassette (postage paid).....\$14.95

Personal checks welcome - no delay.  
Missouri residents add 5.625 percent sales tax.

**Genesis Software**  
P.O. Box 936  
Manchester, Mo. 63011



# THESE FINE STORES CARRY THE RAINBOW

The retail stores listed below carry *the Rainbow* on a regular basis and may have other products of interest to Color Computer users. We suggest you patronize those in your area.

## ALABAMA

Birmingham  
Florence  
Huntsville  
Madison  
Mobile  
Montgomery

Jefferson News Co.  
Software City  
Anderson News Co.  
Software City  
Madison Books  
Computerland  
Trade 'N' Books

## ALASKA

Anchorage  
Fairbanks  
Kotzebue

Radio Shack  
Electronic World  
Arctic Bookstore, Inc.

## ARIZONA

Glendale  
Mesa  
  
Phoenix  
  
  
Scottsdale  
  
Sierra Vista  
Tempe

Road Runner Computer Products  
Personal Computer Place  
Personal Computer Place  
Software Center  
Home Brew Computers  
The Computer Shop  
Software City  
Tri-Teck Computers  
Data Concepts  
Softwareland Corp.  
Livingston Books  
All Systems Go  
Books Etc.  
Computer Library  
Anderson News Co.  
Software City  
Southwest Computer Software  
Soft Shop

## TUCSON

## YUMA

## ARKANSAS

Little Rock

Anderson News Co.

## CALIFORNIA

Alwater  
Citrus Heights  
Downey  
El Cajon  
Extan  
Fortuna  
Half Moon Bay  
Hollywood  
Lancaster  
Los Angeles  
Modesto  
Morro Bay  
National City  
Northridge  
Pacific Beach  
Palo Alto  
Sacramento

Electrabrain  
Software Plus  
The Floppi Disk  
Radio Shack  
Software City  
R&V Sound  
Strawflower Electronics  
Levity Distributors  
Alpha Computer Equip. Co.  
OPAMP Technical Books  
Software Mart  
Coast Electronics  
Willy's Electronics  
HW Electronics  
Pla Am Electronics  
Printers, Inc.  
North Area News  
Software Center

## SAN DIEGO

Computer Dimension  
The Computer Store  
Cast Plus Software  
Dimensional Software  
Disney's Electronics  
Radio Shack  
Software 1st  
Color Computing  
Computer Literacy  
Software Centre Int.  
Adobe Electronics

## SANTA ROSA

Southgate  
Sunnyvale  
Torrance  
29 Palms

Software 1st  
Color Computing  
Computer Literacy  
Software Centre Int.  
Adobe Electronics

## COLORADO

Aurora  
Boulder  
Colorado  
Springs  
Denver  
Westminster

Aurora Newsland  
The Computer Connection  
  
Hathaway's Magazines  
Wholesale Dist.  
Software City

## CONNECTICUT

Danbury  
Hartford  
Orange

Computer Serv. of Danbury  
The Aetna Life Club Store  
Software City

## DELAWARE

Wilmington

Norman, Inc.—The Smoke Shop

## DISTRICT OF COLUMBIA

The Program Store

## FLORIDA

Clearwater  
Cocoa

Soenen & Wilmoth Books  
Space Coast Software

Coconut Creek  
Davie  
Ft. Lauderdale

Holiday  
Kissimmee  
Longwood  
Miami

Orlando

Panama City  
Pensacola  
Sarasota

South  
Pasadena  
Stuart  
Tallahassee  
Tampa

Winter Park  
**GEORGIA**  
Atlanta

Columbus  
Marietta

## IDAHO

Boise

Moscow  
Pocahontas

## ILLINOIS

Aurora  
Champaign  
Chicago

## INDIANA

Indianapolis

## IOWA

Des Moines

## KANSAS

Topeka

## KENTUCKY

Louisville

## LOUISIANA

Baton Rouge

## MAINE

Brockton

## MASSACHUSETTS

Brockton  
Cambridge

## MARYLAND

Baltimore

## MICHIGAN

Ann Arbor

## MICHIGAN

Ann Arbor

## MICHIGAN

Ann Arbor

## MICHIGAN

Ann Arbor

## MICHIGAN

Ann Arbor

Data Base  
Software Plus Home  
Mike's Electronics Distributor  
Software Connection  
Mr. Chips  
Radio Shack & Elec. Hut  
Adventure International Store  
Joe's News  
Micro Byte  
The News Rack  
The Alamo  
All Systems Go  
Software Unlimited  
Computer Systems Group  
Anderson News Co.  
Family Computers  
Software City

Paling Place  
Caribbean Engineering Corp.  
Anderson News Co.  
Software City  
Software Store  
Sound Trader & Computer Center  
Independent Computer Systems

Chips, Inc.  
Guild News Agency  
Hands On Computer  
Software Atlanta  
Software City  
Muscogee News Co.  
Act One Video

Magnum Computer  
Products  
Johnson News Agency  
Wizerdz

Kroch's & Brentano's  
Book Market  
B. Dalton Booksellers  
N. Wolbush St.  
West Jackson St.  
Bab's in Newtown  
Bob's News Emporium  
Bob's Rogers Park  
Book Market  
East Cedar  
North Cicero  
West Diversey  
Chas. Levy Circulating Co.  
E.B. Garcia & Associates  
Guild Books & Periodicals  
Kroch's & Brentano's  
South Wolbush  
West Jackson  
516 N. Michigan  
835 N. Michigan  
Parkway Drugs  
Parkwest Books  
Sandmeyer's Bookstore  
Univ. of Chicago Bookstore  
Univ. of Illinois Bookstore  
Videomat, Inc.  
Book Market  
Appletree Computers  
Chicago-Main News  
J.F.E. Computers  
Book Nook  
Bills TV Radio Shack  
Kroch's & Brentano's  
B.I.E.S. Systems  
Kroch's & Brentano's  
Book Market  
Illinois News Service  
Data Domain  
Kroch's & Brentano's  
Kroch's & Brentano's  
Abacus Computers

Danville  
DeKalb  
Evanston  
Genesis  
Lisle  
Newton  
Oak Brook  
Oak Park

Peoria

Schaumburg

Skokie

S. Holland

Wheeling  
Wood Dale

## INDIANA

Berne  
Crown Point  
Elkhart  
Garrett  
Greenwood  
Indianapolis

Jasper

Lawrenceburg

Madison  
Martinsville  
New Haven  
Scottsburg  
Walbush

## IOWA

Beltsford  
Davenport

## KANSAS

Hays  
Junction City  
Kansas City  
Topeka

Wichita

## KENTUCKY

Benton  
Crestwood  
Harradsburg  
Hapkinsville  
Louisville

Paducah

Paintsville  
Pikeville  
Radcliff

## LOUISIANA

Baton Rouge  
Shreveport  
Slidell

## MAINE

Brockton  
E. Wilton  
Jay  
Lewiston  
South Portland  
Waterboro

## MARYLAND

Baltimore

Kensington

## MASSACHUSETTS

Brockton  
Cambridge

Danvers

Fitchburg  
Ipswich  
Littleton  
Mansfield  
Springfield  
Woburn

## MICHIGAN

Ann Arbor

Brooklyn

Dearborn  
Durand  
Fenton  
Flint  
Kalamazoo

North Shore Distributors  
Pace-Micro Software Centers

White Cottage Electronics  
Unelex Software  
Elkhart City News  
Finn News Agency  
The Computer Experience  
A-Computer Store  
Bookland, Inc.  
Game Preserve  
Indiana News  
Computer Store  
Elex Mart

Bauer Electronics  
Computer Services  
Arcs Office Supplies  
Radio Shack  
Advanced Color Software  
Radio Shack of Scottsburg  
Milling's Electronics

Casmos Computers  
Interstate Book Store  
Software City

Gulliver's Inc.  
III H's Stereo  
Special Computer Support  
Palmer News, Inc.  
Town Crier of Topeka, Inc.  
Amateur Radio Equipment Co.  
Lloyd's Radio

Anderson Electronics  
Begley Drugs  
M & W Electronics  
Hobby Shop  
The Computer Store  
Software City  
Radio Shack  
Gus-Stan Enterprises  
Gus-Stan Enterprises  
Bluebird Enterprises

Acme Book Co.  
Computer SOS  
Radio Shack 7181

Vogager Bookstore  
O'brian's Electronic Svc. Ctr.  
F.M. Electronics  
Computer Software & Education Centers  
Portland News Co.  
Radio Shack

Micro Computer Center  
The Program Store  
The Program Store

Vogager Bookstore  
Ninis Corner, Inc.  
Out Of Town News  
The Program Store  
Microcon Computer & Software Store  
Corners Book Shop  
Ipswich News  
Computer Plus  
Software Shop  
Software City  
Microcon Softwarecenters

Community News Center  
Software City  
Weatherwax Radio Shack  
DSL Computer Products  
Robbins Electronics  
Tri-County Electronics Radio Shack  
"I.O."  
John Rollins



# Setting The Standard

WHAT THEY ARE

forefront of the pack... the Rainbow, Dayton, OH

## CANDY CO.

Can you save Q.P. Doll in the cherry bomb frame?  
Will you have to work overtime in the hour glass  
frame to get the job done?

### Coming Soon

## COLORPEDE

This truly outstanding engineer designed, 100% machine language game with multi-colored high resolution characters and fast action will challenge the most avid arcade buff. Can be played by 1 or 2 players controlled with joy sticks or key board. Joy stick control is fast, smooth and accurate. As COLORPEDE slithers through the load stools, you attempt to destroy the COLORPEDE, knock out the menacing Bouncing Bug and eliminate load stools while accumulating higher and higher scores. Demonstration mode with top 5 scores. Pause feature. For 16K Color Computer and TDP-100.

**Cassette - \$29.95**

**Disk - \$34.95**

## ROBOTTACK

Ultra fast arcade action with colorful high resolution graphics. You are the super human who must fight off the attacking robots and save the remaining humans from destruction. You have super powers, can shoot in any direction and move anywhere on the screen to accomplish your vital mission.

Engineer designed, 100% machine language. Can be played by 1 or 2 players with joy stick control. Top 5 scores displayed. Pause feature. For 16K Color Computer and TDP-100 with joy sticks.

**Cassette - \$24.95**

**Disk - \$27.95**

### TO ORDER:

VISA, MASTERCARD, Money Order. Please allow 2 weeks for checks. Add \$1.50 for shipping, \$3.00 outside U.S. 4% tax in Mich.



# intracolor

## COMMUNICATIONS

P. O. Box 1035, East Lansing, MI 48823  
(517) 351-8537

DEALER INQUIRIES INVITED

QUALITY PROGRAMS SOLICITED



# ADVERTISER'S INDEX

We encourage you to patronize our advertisers—all of whom support the TRS-80 Color and TDP System-100 computers. We will appreciate your mentioning the RAINBOW when you contact these firms.

\*These firms also are offering a special discount coupon which can be found between Pages 226 & 227 and 274 & 275.

Aardvark 80 . . . . .	167	Derringer Software . . . . .	312	Parsons Software . . . . .	118
Access Programs Marketing . . . . .	29	Desert Press, Inc . . . . .	224	P.B.H. . . . .	228
Adventure Contest . . . . .	276	Desert Software . . . . .	193, 275	Peacock Enterprises . . . . .	287
Adventure International . . . . .	17	Dorsett . . . . .	217	Perry Computers . . . . .	282
All-American Ultralight Industries . . . . .	50	Double Density Software . . . . .	218, 219	Petrocci Freelance Associates . . . . .	279
AMDEK Corp. . . . .	97	Dragon User . . . . .	245	Phoenix Enterprises . . . . .	304
Analog Micro Systems . . . . .	77	DSL Computer Products . . . . .	258, 259	P & M Electronics . . . . .	266
Arizona Discount Software . . . . .	49	Dugger's Growing Systems . . . . .	237	Preble . . . . .	225
Ark Royal Games . . . . .	303	Dymax . . . . .	136	Prickly-Pear Software . . . . .	98, 319
Armadillo International . . . . .	247	Dynamic Electronics . . . . .	84	The Programmer's Guild . . . . .	226
Aurora Software . . . . .	240	E.A.P. Co. . . . .	264	The Programmer's Institute . . . . .	25
*Avalon Hill . . . . .	12	Eaton Computer Products . . . . .	164	PXE Computing . . . . .	220
B&B Software . . . . .	76	Elite Software . . . . .	81, 173, 175, 177	Pyramid Distributors . . . . .	121, 234
Basic Technology . . . . .	51	Emerald Computer Service . . . . .	105	Radio Shack . . . . .	10, 11
Bear Bones . . . . .	43, 232	Endicott Software . . . . .	206, 207	Rainbow Connection Software . . . . .	243, 321
Bertamax . . . . .	67	Eng Systems Laboratories . . . . .	230	RAINBOWfest . . . . .	138, 139
B5 Software . . . . .	277	Erickson, B. . . . .	168	RAINBOW Gift Certificate . . . . .	317
Botek Instruments . . . . .	169	*EVS . . . . .	9	Rainbow On Tape . . . . .	234
Calc-Soft . . . . .	246	Federal Hill Software . . . . .	223	Rainbow Poster . . . . .	287
Cer-Comp . . . . .	231	Genesis Software . . . . .	333	Reitz Electronics . . . . .	85
Challenger Software . . . . .	248	GIMIX . . . . .	338	REM Industries . . . . .	95
Chattanooga Choo-Choo Software . . . . .	53	HJL . . . . .	181	S & S Arcade . . . . .	327
Chris Computers . . . . .	286	Hawkes Research Services . . . . .	251	SDS Computers . . . . .	227
Chroma Systems . . . . .	320	Frank Hogg Laboratory . . . . .	22, 23, 86, 87	Saguro . . . . .	94, 294
Chromasette . . . . .	313	Home Base Systems . . . . .	61	Saturn Electronics . . . . .	309
Circling Star Software . . . . .	216	Hot CoCo . . . . .	329	Selected Software . . . . .	263
Classical Computing . . . . .	135	Howard Medical . . . . .	285	Shamrock Software . . . . .	331
CMD Micro Computer Services LTD. . . . .	166	Hoyt Stearns Electronics . . . . .	201	Sigma Software . . . . .	70
CoCo Hut . . . . .	110	HYCOMP Software . . . . .	167	Silverware . . . . .	307
CoCo Pro . . . . .	142	Inter-Action . . . . .	131, 273	Skillware Corporation . . . . .	92, 145, 316
CoCo Warehouse . . . . .	165	International Color Computer Club . . . . .	280	Skyline . . . . .	288, 289
Cognitec . . . . .	15	International Software . . . . .	283	Softlaw Corporation . . . . .	45, 46, 47, 111
Color Connection Software . . . . .	16	*Intracolor . . . . .	336	Software Connection . . . . .	200
Color Micro Journal . . . . .	311	Jade Products . . . . .	192	Software Factory . . . . .	261
Colorquest . . . . .	111	JARB Software . . . . .	89, 195	The Soft Shop . . . . .	66
Color Software Services . . . . .	74, 75	J&M . . . . .	146	*Software Plus . . . . .	
Colortech Systems . . . . .	182	K&K Computers . . . . .	267	*Software Support, Inc. . . . .	119
*Colorware . . . . .	82, 83	KRT Software . . . . .	190	Southern Software Systems . . . . .	115
Compukit . . . . .	233	Key Color Software . . . . .	133	*Spectral Associates . . . . .	239, BC
Computer Accessories of Arizona . . . . .	253	Keytronic . . . . .	137	*Spectrum Projects . . . . .	153, 154
The Computer Center . . . . .	174	Leader Sales Corporation . . . . .	190, 236	Speech Systems . . . . .	155, 157, 158, 159, 160
The Computer House . . . . .	221	Leading Edge . . . . .	IBC	Star-Kits . . . . .	268, 269
Computer Island . . . . .	151	Magnum Distributors, Inc. . . . .	144	Sugar Software . . . . .	102, 103
Computer Plus . . . . .	3	*Mark Data Products . . . . .	18, 19, 20	Superior Graphics Software Products . . . . .	298, 299
Computer Systems Center . . . . .	183	MichTron . . . . .	35, 37, 39, 41	Syntactics . . . . .	235
Computerware . . . . .	122, 123, 124	Marymac Industries . . . . .	278	T & D Software . . . . .	50
Computize Inc. . . . .	125, 126, 127, 128, 129	Microcom Software . . . . .	38	T & S Electronics . . . . .	249
Cosmos Computer Services, Inc. . . . .	229	Micro Data Systems . . . . .	59	Tano Microcomputer Products Corp. . . . .	113
CounterPoint Software Inc. . . . .	7	Micro-80 . . . . .	242, 260	Transition Technology . . . . .	295
Creations Unlimited . . . . .	240	Micro Magic . . . . .	256	True Data Products . . . . .	189
Creative Technical . . . . .	109	Micronix . . . . .	55	Unit One Software . . . . .	136
Custom Software Engineering . . . . .	293	Micro Tools, Inc. . . . .	271	Valhalla Enterprises . . . . .	270
CY-BURNET-ICS . . . . .	244	The Micro Works . . . . .	185	VAL Systems . . . . .	199
Data-Camp . . . . .	250	*Tom Mix Software . . . . .	IFC, 73, 170, 171, 305	Vidtron . . . . .	38
Dataman . . . . .	116, 117	ML-US'R Software . . . . .	100	Wasatchware . . . . .	216
Dayton Associates Of W.R. Hall, Inc. . . . .	208	Moreton Bay . . . . .	241	Wayne Technology . . . . .	42
Deft Systems, Inc . . . . .	255	Nanos Systems Corp. . . . .	257	The West Bay Company . . . . .	326
Delker Electronics . . . . .	33, 222	Nelson Software Systems . . . . .	45, 46, 47	Wood Heat . . . . .	222
		Oelrich Publications . . . . .	214	Woodstown Electronics . . . . .	191
		Oregon Color Computer . . . . .	236	York-10 . . . . .	252
		Owl's Nest Software . . . . .	107		
		Pal Creations . . . . .	215		

# GIMIX STATE OF THE ART 6809 SYSTEMS FOR THE SERIOUS USER.



**GIMIX has 19MB or high performance  
47MB Winchester Drive Systems and/or  
Floppy Disk Drive Systems.**

For the ultimate in performance, the Unique GMX 6809 CPUIII, using either OS-9-GMXIII or UniFLEX GMXIII (available shortly), gives protection to the system and other users from crashes caused by defective user programs. e.g. During program development, a programmer who crashes goes back to the shell or the debugger, while the other users are not even aware anything occurred.

The intelligent serial I/O processor boards significantly reduce system overhead by handling routine I/O functions, thereby freeing up the host CPU for running user programs. This speeds up system performance and allows multiple terminals to be used at 19.2K baud.

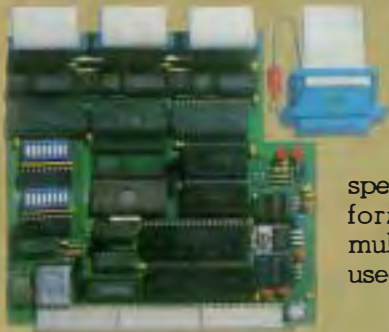

BASIC-09 and OS-9 are trademarks of Microware Systems Corp. and MOTOROLA, Inc.  
FLEX and UniFLEX are trademarks of Technical Systems Consultants, Inc.  
GIMIX, GHOST, GMX, CLASSY CHASSIS, are trademarks of GIMIX, Inc.

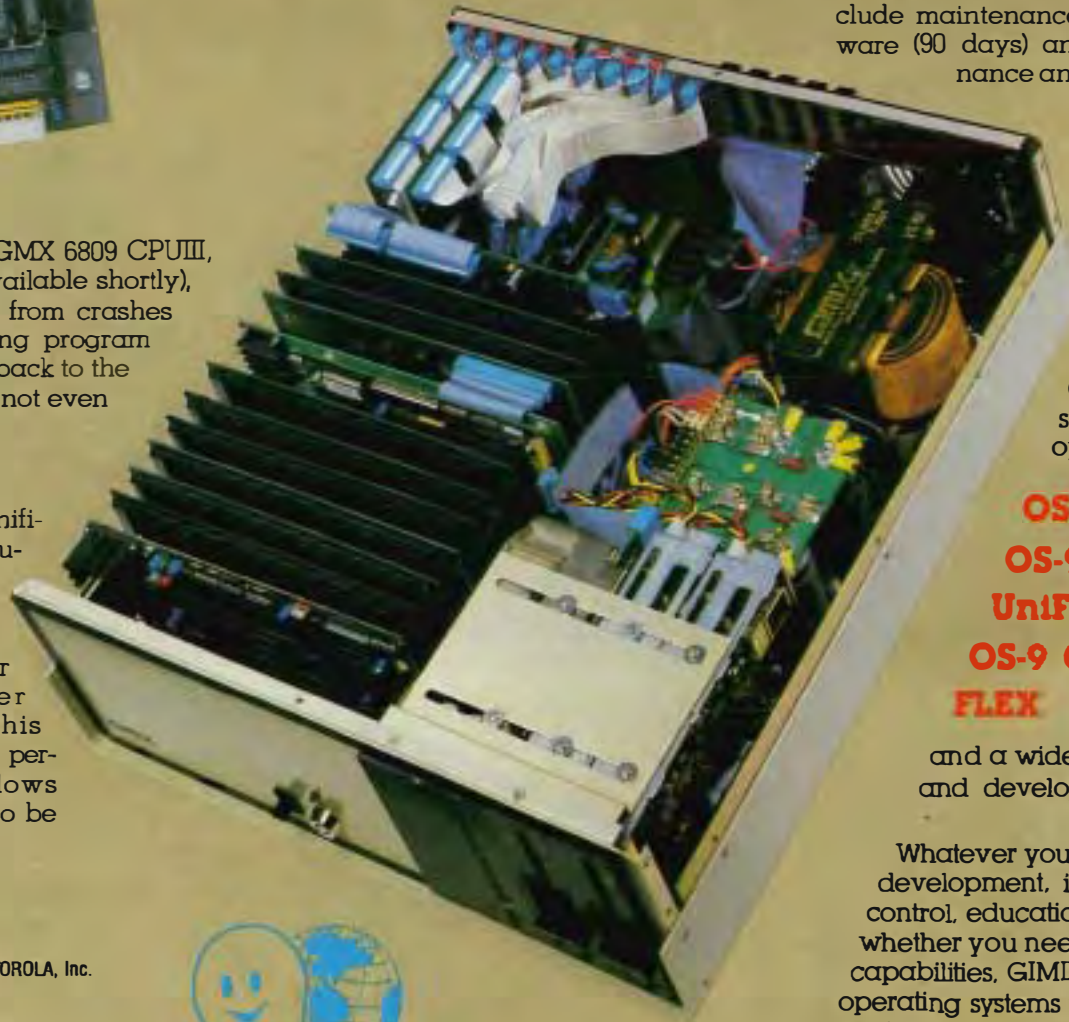

For the user who appreciates the need for a bus structured system using STATIC RAM and powered by a ferro resonant constant voltage transformer.

GIMIX has single user systems that can run both FLEX and OS-9 or Multi user systems for use with UniFLEX or OS-9.

GIMIX versions of OS9 and UniFLEX include maintenance and support by Microware (90 days) and TSC (1 year). Maintenance and support after this period are available at extra cost.

(NOTE: this support and maintenance is only for use with approved GIMIX hardware)

GIMIX 6809 systems support five predominant operating systems:

**OS-9 GMX III,  
OS-9 GMX II,  
UniFLEX,  
OS-9 GMX I,  
FLEX**

and a wide variety of languages and development software.

Whatever your application: software development, instrumentation, process control, educational, scientific or business; whether you need single or multi-user capabilities, GIMIX has hardware and the operating systems to get the job done reliably.

Please phone or write if you need further information.

**GIMIX** inc.

1337 WEST 37th PLACE • CHICAGO, ILLINOIS 60609 • (312) 927-5510 • TWX 910-221-4055

© 1983 GIMIX Inc.



# REMEMBER.



## ELEPHANT™ NEVER FORGETS.

*A full line of top-quality floppies, in virtually every 5 1/4" and 8" model, for compatibility with virtually every computer on the market. Guaranteed to meet or exceed every industry standard, certified 100% error-free and problem-free, and to maintain its quality for at least 12 million passes (or over a lifetime of heavy-duty use).*

Contact Dennison Computer Supplies, Inc., 55 Providence Highway, Norwood, MA 02062 or call toll-free 1-800-343-8413. In Massachusetts, call collect (617) 769-8150. Telex 951-624.

Dennison

# SPECTRAL ASSOCIATES

3416 South 90th Street  
Tacoma, WA 98409

# CUBIX



Excitement mounts in this fantastic 3D Cube Maze game as CUBIX attempts to change the colors of the squares while villainous creatures conspire to prevent him from completing his task. A constant array of "Snake Eggs" and "Death Globes" drop from the sky and bounce around the pyramid threatening to give CUBIX a bop on the head, and just to keep things hopping (literally) "Sprink" and "Flip" appear later in the game to undo his work by changing the squares back to their original colors.

Call or write for a complete catalog  
Business Office and Information Call:  
..... (206) 581-6938  
Office open 8:30-4:30 P.S.T.

For Orders Only  
**1-800-426-1830**  
except WA, AK, HI

We accept VISA, MASTERCARD  
Add 3% for shipping. NO C.O.D.  
All prices U.S. FUNDS.  
WA residents add 7.8% sales tax.

**DEALER INQUIRIES INVITED**