

August 1988

Canada \$4.95 U.S. \$3.95

Just for your
Tandy Color
Computer 1, 2 and 3

RAINBOW

The

THE COLOR COMPUTER MONTHLY MAGAZINE

All the Right Moves

CoCo Chess, Sea War,
Talking Bingo and
Escape From Tut's Tomb

Our
Annual
Games
Issue!

- Learn to Create High-Quality Games in Assembly Language
- Keep Track of the Body Count in Role-Playing Games
- Compare Disk Files for Duplicates
- Convert ML Into BASIC

SUB 38538 EXP 8809 RBDW08/88
HARRY N HARMON
1404 VILLAGE AVE
LOVELAND CO 80538

Comparison Chart,
File Mapping Techniques,
Switcheroo II and More!





DIECOM PRODUCTS INC.

HIGH SCORE	76,558
PLAYER 1	14,500
ENERGY	
BULLETS	47
GRENADES	59
PLAYER 2	9,250
ENERGY	
BULLETS	71
GRENADES	38

Requires 64 k and one joystick. For the Coco 1, 2 or 3

MISSION: RUSH'N ASSAULT

One or two players can take on the mission to rescue POW's hidden deep inside enemy territory. Watch out for enemy soldiers, snipers, grenade launchers and many other hazards as you journey farther over enemy lines. Forge your way through jungles and swamps and other hazardous terrain as you search for the missing soldiers. Pick up grenades, extra ammo and more powerful weapons as you continue farther into your mission. The enemy is out in great force to stop your mission. Dozens of screens will keep you playing for hours. Can you succeed and rescue the prisoners? Only time will tell.

Tape or Disk
\$28.95 U.S.
\$38.95 Can.

LAP # 2 SCORE 4,550

Requires 128 k Coco 3 with one joystick.

GRANDPRIX CHALLENGE

Race alone against the computer, or with a friend against the computer in this high speed racing game. You compete in 5 lap races around twisting and turning race courses. Finish the race ahead of all the computer cars and you will progress to a more challenging course. Collect repair tools as you race around the track and you will be able to increase the speed and handling of your race car. But watch out for oil slicks and water puddles on the track or you might find your car crashing into a wall. Detailed 320 x 200 graphics and realistic driving conditions make this a must for your Coco 3 collection. Many different race tracks will keep you challenged.

Disk **\$28.95 U.S.** **\$38.95 Can.**

LEVEL 1

HITARD	100	500
HEALTH	1000	1000
SCORE		
HEALTH	100	1000
SCORE		
HARBOR	100	1000
HEALTH	100	1000
SCORE		

Requires 128 k Coco 3

GANTELET II

It's back and better than ever. It's Gantelet II for your Coco 3. Using 320 x 200 hi-res graphics with 16 colors, we have created one of the best arcade style games you will ever see for your Coco. Four people can now play simultaneously in one game. Dozens of new levels with new monsters will challenge even the best players. Collect keys to open doors and chests, treasures, and many new magic potions to help you battle more powerful monsters. Watch out for hidden traps as you search for the exit to next level.

Disk **\$28.95 U.S.** **\$38.95 Can.**

CALADURIL FLAME OF LIGHT



LANSFORD MANSION



NEW LOW PRICE ON CALADURIL FLAME OF LIGHT & LANSFORD MANSION, AVAILABLE ON DISK ONLY
\$28.95 U.S.
\$38.95 Can.

ALSO AVAILABLE: MISSION: F-16 ASSAULT • PAPER ROUTE • KNOCK OUT • KARATE • MARBLE MAZE

DIECOM PRODUCTS INC.

6715 FIFTH LINE, MILTON, ONT., CANADA L9T 2X8

24 hr. order line:
 (416) 878-8358
 personal service 9-5

Please add \$2 shipping & handling (for 'The Rat' and 'Iron Forest' add \$5 each for shipping). Ontario residents add 7% sales tax. C.O.D. Canada only.

We accept:

 cheque or money order

\$28.95 U.S.
\$38.95 CAN.
 AVAILABLE ON TAPE OR DISK
 64K REQUIRED

From Computer Plus to YOU ...

PLUS after PLUS after PLUS

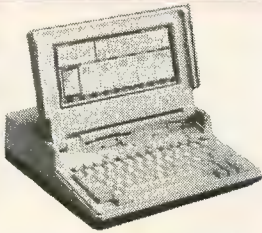

Tandy 1400 LT \$1239
Tandy 102 24K \$379
Tandy 200 24K \$429



Color Computer 3
w/128K Ext. Basic \$159

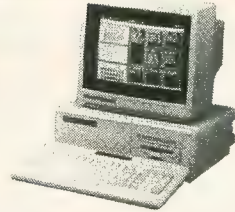

Tandy 1000 HX \$539
Tandy 1000 TX \$849*

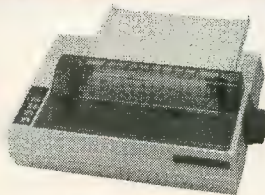

DMP-132 \$289

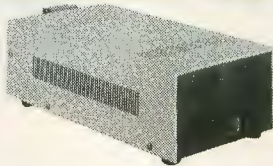

Color Computer Disk Drive
Drive 0 \$249 Drive 1 \$149

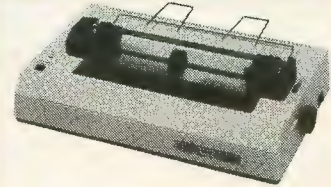

DMP-106 \$169

BIG SAVINGS ON A FULL COMPLEMENT OF RADIO SHACK COMPUTER PRODUCTS

COMPUTERS

Tandy 1000 HX 1 Drive 256K	539.00
Tandy 1000 TX 1 Drive 640K	849.00*
Tandy 1000 SX 1 Drive 384K	499.00*
Tandy 3000 HL 1 Drive 512K	1129.00
Tandy 4000 1 Drive 1 Meg. Ram	1959.00

PRINTERS

Radio Shack DMP-106 80 CPS	169.00
Radio Shack DMP-132 120 CPS	289.00
Radio Shack DMP-440 300 CPS	549.00
Radio Shack DWP-230 Daisy Wheel	349.00
Tandy LP-1000 Laser Printer	1699.00
Star Micronics NX-1000 144 CPS	199.00
Star Micronics NX-15 120 CPS	359.00
Panasonic P-1080i 144 CPS	199.00
Panasonic P-1091i 194 CPS	249.00
Panasonic P-1092i 240 CPS	349.00
Okidata 182+ 144 CPS	259.00
Okidata 192+ 200 CPS	359.00
Okidata 292 240 CPS	479.00

MODEMS

Radio Shack DCM-6	52.00
Radio Shack DCM-7	85.00
Practical Peripheral 2400 Baud	229.00
Practical Peripheral 1200 Baud	149.00

COLOR COMPUTER MISC.

Radio Shack Drive Controller	99.00
Extended Basic Rom Kit	14.95
64K Ram Upgrade Kit	39.00
Radio Shack Deluxe Keyboard Kit	24.95
HI-RES Joystick Interface	8.95
Color Computer Deluxe Mouse	44.00
Multi Pak Interface	89.00
Multi Pak Pal Chip for COCO 3	14.95
CM-8 6' Extension Cable	19.95
Serial to Parallel Conv.	59.95
Radio Shack Deluxe Joystick	26.95
Magnavox 8515 RGB Monitor	329.00
Radio Shack CM-8 RGB Monitor	249.00
Radio Shack VM-4 Green Monitor	99.00
PBJ 512K COCO 3 Upgrade	139.00
Tandy 512K COCO 3 Upgrade	149.00
Mark Data Universal Video Driver	29.95

COLOR COMPUTER SOFTWARE

	TAPE	DISK
The Wild West (CoCo3)		25.95
Worlds Of Flight	34.95	34.95
Mustang P-51 Flight Simul.	34.95	34.95
Flight 16 Flight Simul.	34.95	34.95
COCO Util II by Mark Data		39.95

COCO Max II by Colorware	79.95
COCO Max III by Colorware	79.95
AutoTerm by PXE Computing	29.95
TelePatch III by Spectrum	29.95
TW-80 by Spectrum (CoCo3)	39.95
TeleWriter 64	49.95
Elite Word 80	79.95
Elite Calc 3.0	69.95
CoCo3 512K Ram Disk by CerComp	19.95
Home Publisher by Tandy (CoCo3)	35.95
Sub Battle Sim. by Epyx (CoCo3)	26.95
Thexder by Sierra (CoCo3)	22.45
Kings Quest III by Sierra (CoCo3)	31.45
Flight Sim. II by SubLogic (CoCo3)	31.45
OS-9 Level II by Tandy	71.95
OS-9 Development System	89.95
Multi-View by Tandy	44.95
VIP Writer (disk only)	69.95
VIP Integrated Library (disk)	149.95

*Sale prices through 8/30/88
Prices are subject to change without notice. Please call for shipping charges. Prices in our retail store may be higher. Send for complete catalog.

CALL TOLL FREE 1-800-343-8124

- LOWEST POSSIBLE PRICES
- BEST POSSIBLE WARRANTY
- KNOWLEDGEABLE SALES STAFF
- TIMELY DELIVERY
- SHOPPING CONVENIENCE



computer plus

P.O. Box 1094
480 King Street
Littleton, MA 01460

SINCE 1973

IN MASSACHUSETTS CALL (617) 486-3193

RAINBOW

Table of Contents

August 1988
Vol. VIII No. 1

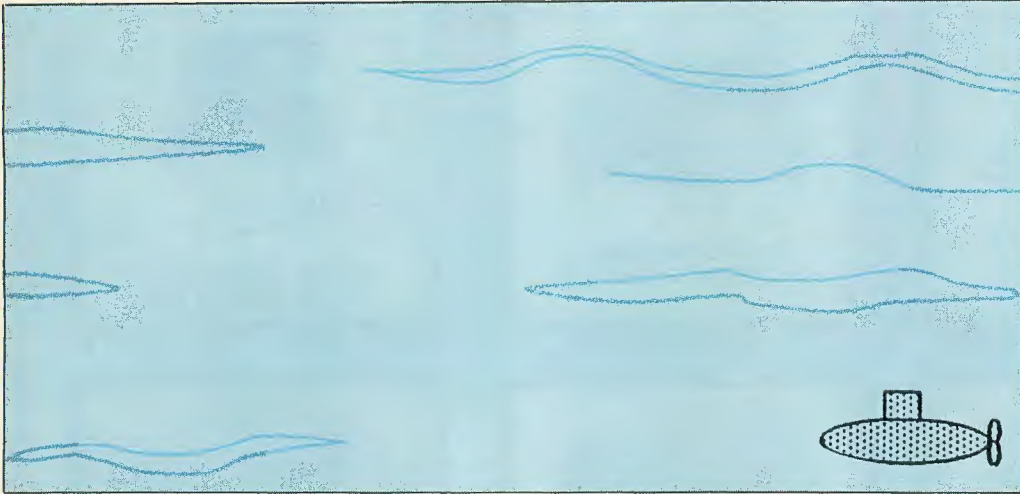

20

Features

16
The Crazy Pool Ball Explained
Bruce W. Ronald
Solution to last month's logic problem

20
Sea War 
Jeff Hameluck
There are ships out there — waiting for you!

28
It's Your Move 
Joel F. Klein
Test your skill with this strategic game of chess

36
CoCo Takes a Hint 
Dennis H. Weide
A program to help you compare disk files for duplicates

38
Bingo the CoCo Way 
Bruce K. Bell, O.D.
An old favorite with some added bells and whistles

44
Child's Play 
Bill Bernico
You won't lose the pieces in this bug-making game!

53
Emphasize 
with the DMP-105
David Francis
Printing in italics on the Tandy DMP-105 printer

58
Escape from Tut's Tomb, Parts 2 and 3 
Chris McKernan
Just when you thought it was safe to go back into the tombs . . .

87
The "Hit" List 
Andrew Dater
Keep track of the body count in role-playing games

100
ML-Data 
Stephen Miller
A routine to convert a machine language program into BASIC

102
The Little Graphics Library 
Kevin Dowd
A tutorial to help you create great games and Simulations in CoCo's own language

114
Adventure Game Mapping Techniques

John Dillon
Simplify and organize Adventure playing without ruining the fun

120
The Old Switcheroo II
Mark Haverstock
A hardware project to handle the switching of the joystick and cassette ports

137
High Finances 
William P. Nee
Machine language made BASIC, Part 2

142
Printer Diversions and Conversions
Cray Augsburg
Using control codes to enhance your printer's capabilities

150
Are You Missing Something?
Roger D. Dowd
Isolating and repairing keyboard problems

156
Working Together: Delphi and Tape I/O 
Don Hutchison
Downloading programs using Radio Shack's Direct Connect Modem Pak

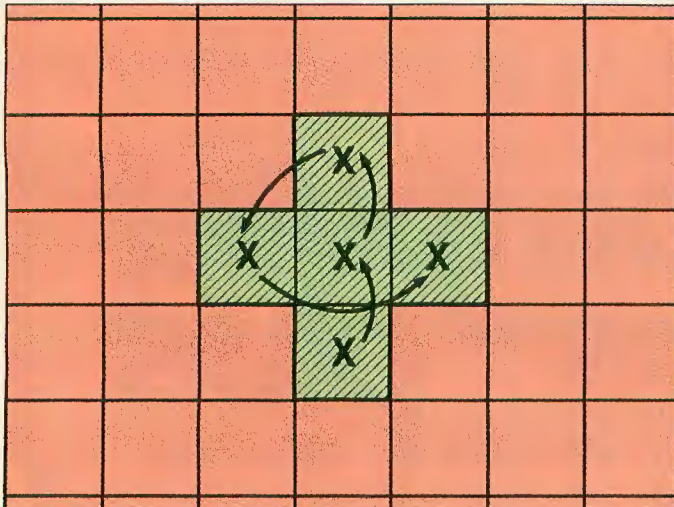

Novices Niche

- 76**
Seeking Immortality
 Paul Alger
- 77**
Minding Your X's and Y's
 James Kevin Lowry
- 78**
Space Attack
 John T. Wells
- 78**
Winging It
 Chad Presley
- 79**
What's Missing?
 Keiran Kenny

 The cassette tape/disk symbols beside features and columns indicate that the program listings with those articles are on this month's RAINBOW ON TAPE and RAINBOW ON DISK. Those with only the disk symbol are not available on RAINBOW ON TAPE. For details, check the RAINBOW ON TAPE and RAINBOW ON DISK ad on Page 52.

Departments

Advertisers Index	192
Back Issue Info	71
CoCo Cat	33
CoCo Gallery	34
Hints	169
Letters to Rainbow	6
Maxwell Mouse	41
One-Liners	81, 89, 117
Racksellers	190
Rainbow Info	14
Received & Certified	136
Scoreboard	84
Scoreboard	
Pointers	86
Submitting Material to Rainbow	187
Subscription Info	189

Columns

- 82**
BASIC Training
 Joseph Kolar
The "Encyclopedia CoColoria"
- 162**
CoCo Consultations
 Marty Goodman
Just what the doctor ordered
- 152**
Delphi Bureau
 Cray Augsburg
Help and a place of your own, and Hutchison's database report
- 165**
Doctor ASCII
 Richard Esposito
The question fixer
- 80**
Education Notes 
 Steve Blyn
Interpreting a newspaper collection chart
- 10**
PRINT#-2,
 Lawrence C. Falk
Editor's notes
- 167**
Turn of the Screw
 Tony DiStefano
All about serial packs
- 92**
Wishing Well 
 Fred Scerbo
Matching opposites
- 170**
Barden's Buffer 
 William Barden, Jr.
Assembly language interrupts and BASIC "internals"
- 182**
KISSable OS-9 
 Dale L. Puckett
Volunteers build a better mousetrap

Rainbowtech

Product Reviews

Flight Simulator II/SubLOGIC Corporation	132
Fraze Craze/RAM Electronics	128
In Quest of the Star Lord/Sundog Systems	133
Mini Database/Tothian Software, Inc.	133
Power Stones of Ard/Three C's Projects	134
RS-232 Switcher/Radcomp Computers	135
Syntax 2.0/Intercomp Sound	128
Thexder/Sierra On-Line, Inc.	134
Wargame Designer/SPORTSware	126

THE RAINBOW is published every month of the year by FALSOFT, Inc., The Falsoft Building, 9509 U.S. Highway 42, P.O. Box 385, Prospect, KY 40059, phone (502) 228-4492. THE RAINBOW, RAINBOWfest and THE RAINBOW and RAINBOWfest logotypes are registered ® trademarks of FALSOFT, Inc. • Second class postage paid Prospect, KY and additional offices. USPS N. 705-050 (ISSN No. 0746-4797). POSTMASTER: Send address changes to THE RAINBOW, P.O. Box 385, Prospect, KY 40059. Authorized as second class postage paid from Hamilton, Ontario by Canada Post, Ottawa, Ontario, Canada. • Entire contents copyright © by FALSOFT, Inc., 1988. THE RAINBOW is intended for the private use and pleasure of its subscribers and purchasers and reproduction by any means is prohibited. Use of information herein is for the single end use of purchasers and any other use is expressly prohibited. All programs herein are distributed in an "as is" basis, without warranty of any kind whatsoever. • Tandy, Color BASIC, Extended Color BASIC and Program Pak are registered ® trademarks of the Tandy Corp. • Subscriptions to THE RAINBOW are \$31 per year in the United States. Canadian rates are U.S. \$38. Surface mail to other countries is U.S. \$68, air mail U.S. \$103. All subscriptions begin with next available issue. • Limited back issues are available. Please see notice for issues that are in print and their costs. Payment accepted by VISA, MasterCard, American Express, cash, check or money order in U.S. currency only. Full refund after mailing of one issue. A refund of 10/12ths the subscription amount after two issues are mailed. No refund after mailing of three or more magazines.

The Rainbow

- Editor and Publisher**
 Lawrence C. Falk
- Managing Editor** Jutta Kapfhammer
- Associate Editor** Sue Fomby
- Reviews Editor** Lauren Willoughby
- Submissions Editor** Angela Kapfhammer
- Copy Editor** Beth Haendiges
- Technical Editors** Cray Augsburg, Ed Eilers
- Technical Assistant** David Horrart
- Editorial Assistants** Sue H. Evans, Wendy Falk
- Contributing Editors**
 William Barden, Jr.,
 Steve Blyn, Tony DiStefano,
 Richard Esposito,
 Martin Goodman, M.D.,
 Joseph Kolar, Dale Puckett,
 Fred Scerbo, Richard White
- Art Director** Heidi Maxedon
- Designers** Sharon Adams,
 Robert Hatfield, Jr., Denise Webb
- Typesetter** Eloise Gaines

Falsoft, Inc.

- President** Lawrence C. Falk
- General Manager** Bonnie Frowenfeld
- Asst. General Mgr. for Finance**
 Donna Shuck
- Admin. Asst. to the Publisher**
 Sarah Levin
- Editorial Director** John Crawley
- Asst. Editorial Director** Judi Hutchinson
- Senior Editor** T. Kevin Nickols
- Director of Production** Jim Cleveland
- Chief Bookkeeper** Diane Moore
- Dealer Accounts** Judy Quashnock
- Asst. General Manager For Administration**
 Sandy Apple
- Word Processor Manager**
 Patricia Eaton
- Customer Service Manager**
 Beverly Bearden
- Customer Service Representative**
 Carolyn Fenwick
- Development Coordinator** Ira Barsky
- Chief of Printing Services** Melba Smith
- Dispatch** Tony Olive
- Business Assistants** Anne Brooks,
 Laurie Falk
- Chief of Building Security and Maintenance**
 Jessie Brooks
- Advertising Coordinator** Doris Taylor
- Advertising Representatives**
 Belinda Kirby, Kim Vincent
- Advertising Assistant** Debbie Baxter
 (502) 228-4492

For RAINBOW Advertising and Marketing Office Information, see Page 192

Cover photograph copyright © 1988 by John R. Longino
 Art direction by Heidi Maxedon

BACK TALK

Editor:

I read the "Building May's Rainbow" column, and I'm surely glad to hear that there are plans to diversify the magazine instead of sticking so rigidly to the monthly theme. The magazine has become quite predictable because of the theme format.

I'm also glad to hear that you plan to publish a cross-reference to the various printers, showing the different printer codes and what they do. There are some great programs in this year's Printer issue, but I'm not able to utilize many of them. I use an Epson printer, and many of the Tandy DMP printer codes are quite different from the Epson's. I'm sure there are many CoCoists who use different printers on the market. By the time the next Printer issue comes around, let's hope that there will be some kind of cross-reference so we can use the programs in that issue.

Val Burke
Red Oak, GA

There's no need to wait for our next Printer issue, Val. See Cray Augsburg's "Printer Diversions and Conversions" beginning on Page 142 of this issue.

A Different Prescription

Editor:

There were a couple of questions and answers in the May '88 "Dr. ASCII" column that I would like to comment on.

First of all, the "Dr. ASCII" column is worth its weight in hard disks, and both answers were correct. I'd simply like to provide alternate solutions to the reader's questions. (Besides, it gave me another good excuse to use Delphi.)

In the first question, titled "If You Fall Into an Error Trap," Mr. Lute states that on his CoCo 3, an FC Error comes up as error number -1, instead of error number 4, as the manual states. His problem just might be that he is trying to get the Error Number (ERNO) value from the direct mode (that's when the CoCo is waiting for you to insert or edit lines, etc.). When the CoCo 3 enters the direct mode, it resets the value of ERNO to -1. So no matter what the actual error number was, the result would always be -1.

To solve the problem, you might insert a statement like: ER=ERNO:EL=ERLIN into your error trap routine. Then when the program halts because of an error, you can type: PRINT ER,EL and get correct results.

In the second question, titled "High Poking Disk BASIC I.I.," Mr. Bradley wants to know why his disk gets trashed in the double speed mode, while some other people

use it all of the time with no troubles at all. The Dr. says it's probably caused by an old 12-volt disk controller.

It might also be caused by the drive itself. Disk BASIC uses a series of fixed time delays when accessing the disk drive. The one that causes the most trouble when using the double speed mode is the track-to-track step rate.

If you're using drives with a 30-ms step rate, which is standard for the older drives (and Disk BASIC), and you try using the double speed mode, you're pushing the drive past its speed limit because the 30-ms time delay is converted to 15-ms when using the double speed mode. The person that is having no trouble in high speed might be using drives that can handle 15-ms — or faster — step rates.

Ken F. Halter
Chino, CA

REVIEWING REVIEWS

Editor:

I wish to comment on both the product, *Telewriter-128*, and the review of it in the May '88 issue.

The excellent review caused me to buy the product, which is superb. Indeed, the review seriously understates the excellence of this latest *Telewriter*. However, I would like to provide one or two suggestions and minor criticisms that may save other readers time when they install *TW-128*; I'll cover those first.

Older versions of *Telewriter* were sometimes DOS-sensitive; they would run fine under Disk BASIC, but misbehave under the more advanced optional DOSs some of us use. The review should have stated that *TW-128* is more widely compatible; I am running it primarily on ADOS-3, but I have run it on four other DOSs, only one of which was Disk BASIC. There was one minor glitch — the *CONVRT64* auxiliary program (for transferring old *TW-64* .BIN files to *TW-128* .TXT format) is DOS-sensitive in Line 450. If it hangs on, you go to a different DOS. That auxiliary program is only used occasionally, so this is not a significant glitch. However, the entire documentation to *CONVRT64* is inside the program just after it hangs, which leads me to a frustrating hour or so!

Nowhere in the documentation does it state whether this version is compatible with a RAM disk. Earlier ones were not, so it would be nice to know. However, so far none of my files have been big enough to try my RAM disk; and with a 48K buffer, few users will need one.

There should be some way to dump the

eight screens of help listings to hard copy. CTRL-H is fast, easy, well-written and convenient. But I want to screen dump it for my file folder and haven't been able to so far. How does one do that?

The review fails to mention one vital point: The macros allow recursive use! It's not even mentioned in the manual. Why is that important? It took me six macros to define all the non-printing junk with which I frequently preface my documents — tab settings, embedded control codes, formatting instructions, and a short, non-printing description of each of these. Because each macro can be included in other macros, I was able to define a series of single-stroke macros to provide all the non-printing stuff plus my home or business letterhead. On earlier versions, I kept a series of dummy files to read in and append to for this purpose. Now, instead of four or five such files, I have one systems file, *TW*DEFS*, which sets up all of these with a single keystroke at the start of any document.

TW-128 deserves even more praise than RAINBOW gave it.

H. Larry Elman
Port Jefferson, NY

HINTS & TIPS

Editor:

My old CoCo 1 "died" and was replaced with a new CoCo 3. As I am a one-hand, one-finger typist, I was scared stiff. All those special extra keys were quite intimidating to me.

As I struggled to master the monster, it gradually dawned on me that this new CoCo 3 was easier to use than the CoCo 1. The CTRL key gives me an un-shifted =, and both CTRL and ALT are duplicated at the right side of the keyboard. So, only a few exotic moves are barred to me. (I have little desire to gaze at the picture of the three bearded magi imbedded in the CoCo 3 guts.)

A new generation of users needs to be informed of the A and E commands in the edit mode. Microsoft seems to have carried over the edit module from the programs in other early Tandy micros. The E command is valuable because it allows you to escape from a mistake, putting you back in the command mode at square one, so you can untangle your fingers and re-enter edit mode without loss of ten minutes' labor.

The A command seems to do what the L command does — print the line and put you at the beginning.

I see the CoCo 3 still has the old *DLOAD* command, no longer operative from Disk BASIC. Was dere a reason for dis, or was it chust sloppy verk by der magi?

Bob Russ
Walworth, WI

RUNS ON
COCO 2 & 3

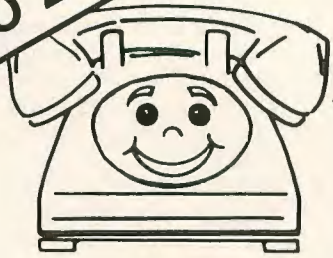

AUTOTERM TURNS YOUR COLOR COMPUTER INTO THE WORLD'S SMARTEST TERMINAL!



YOU'LL ALSO USE AUTOTERM FOR SIMPLE
WORD PROCESSING & RECORD KEEPING

EXTRA FEATURES ON COCO 3 DISK

80 char. screen, 2400 baud thru serial port,
95,000 to 475,000 character buffer.

EASY COMMUNICATION + WORD PROCESSING + TOTAL AUTOMATION

Full prompting and error checking. Step-by-step manual has examples. Scroll text backward and forward. No split words on screen or printout. Save, load, delete files while on line. Print, save all or any part of text. 300 or 1200 baud. All 128 ASCII characters. Works with D.C. Hayes or any modem. Screen widths of 32, 40, 42, 51, 64.

DISK VERSION SUPPORTS RS232 PAK, XMODEM and SPLIT SCREEN FOR PACKET RADIO.

Editing is super simple with the cursor. Find strings instantly too! Insert printer control codes. Specify page size and margins. Switch quickly between word processing and intelligent terminal action. Create text, correct your typing errors; then connect to the other computer, upload your text or files, download information, file it, and sign-off; then edit the receive data, print it in an attractive format, and/or save it on file. Compatible with TELEWRITER.

Advanced system of keystroke macros lets you automate any activity, such as dial via modem, sign-on, interact, sign-off, print, save. Perform entire session. Act as message taker. At start-up, disk version can automatically set parameters, dial, sign-on, interact, read/write disk, sign-off, etc. Timed execution lets AUTOTERM work while you sleep or play. No other computer can match your COCO's intelligence as a terminal.

Please hire the mentally retarded. They are sincere, hard working and appreciative. *Thanks!*

Phyllis.

CASSETTE \$29.95

DISKETTE \$39.95

Add \$3 shipping and handling
MC/VISA/C.O.D.

PXE Computing

11 Vicksburg Lane
Richardson, Texas 75080
214/699-7273

Saving CoCo's Three Wise Men

Editor:

Here's a trick for the new CoCo 3. Almost everyone knows that when you press CTRL and ALT with the reset button pressed, you get a picture with three people and their names. So what's the new trick? The picture is stored on the PMODE4 graphics screen. When viewing this screen, you will see only the three people (not their names). To save this screen use the following steps: First, type PCLS1 and press ENTER. Press CTRL and ALT. Leaving them down, press the reset button. Release CTRL and ALT, press the reset button again, and the computer will cold start. Next, type in the following lines:

```
10 PMODE4:SCREEN1,1
20 CSAVEM"COCOTRIO",1536,7679,1536
```

Press the record button on your tape recorder and run the program. After the program is done, rewind the recorder to the beginning of the file and change Line 20 to: 20 CLOADM"COCOTRIO". Press play and run the program. To have the screen on disk, type in Line 20 as: 20 SAVEM"COCO TRIO",3584,9727,3584, have your disk in the disk drive and run the program. Then change Line 20 to: 20 LOADM"COCOTRIO" and type Line 30 as: 30 GOTO 30. Run the program.

*Mike Craig
South Haven, MI*

REQUEST HOTLINE

Editor:

I got my first CoCo in 1984, and I had a subscription to RAINBOW for two years. I stopped my subscription because I outgrew it. I know you've got to keep the little tykes entertained, but how about me? I'm 36 years old.

At work I am building an equipment monitoring system using a CoCo that has 24 slave 8255 chips selected by a primary and a secondary master 8255 chip and an using techniques found in your magazine. The system is about 50 percent operative.

I've become sick and tired of slow BASIC program games, and I don't want to bother with OS-9. Assembly language programming is what I want to learn — specifically how to program graphics games using Radio Shack's Assembler. I have TRS 80 Color Computer Assembly Language Programming by William Barden, but it is definitely not game-oriented. I also have a copy of Don Inman's Assembly Language Graphics for the TRS 80 Color Computer, but it was written for a different assembler; as expected, when I type in the programs, they don't work.

Would you please devote a section in RAINBOW to helping me and many others grow into a higher level of programming, using assembly language game tutorials? I

am ready to advance beyond Beginner's All Purpose, Symbolic Instruction Code.

*Richard T. Maelhorn
State College, PA*

See William Nee's second installment of "Machine Language Made BASIC on Page 137 of this issue. His 13-part series of ML tutorials, which began in last month's issue, will continue monthly through August '89.

Also, check out "The Little Graphics Library" by Kevin Dowd on Page 102 of this issue.

Printer Codes

Editor:

All of us have various types of printers; when a truly great program comes along and the author has not included the remarks regarding setting the printer codes, it is very frustrating to those who are not great programmers — or not programmers at all.

It would be a great service if this was one of the requirements when submitting a program to RAINBOW. In most cases, we can then go to our individual printer books, look up and change the codes, and *voila*, the program works.

I was very happy to see in the May issue one or two programs where the authors did this, and I commend them for thinking of us who need this. They put down the lines

and the codes, which was such a help.

I love your magazine and wait by my mailbox every month for it to arrive. Thanks to all of you who slave over your desks to bring this fine magazine to your readers.

*Dorothy J. Konig
Perris, CA*

See Page 142 of this issue for coverage of printer control code differences.

KUDOS

Editor:

T & D Subscription Software is to be commended for their prompt service and reliability. Most orders are received within 10 days instead of the usual four-to-six weeks. Anybody looking for great software and excellent service should patronize this company.

*W.A. Queen III
Bessemer City, NC*

Up and Running

Editor:

Just a note to tell you about the good people of Second City Software: Ed Hathaway and Dave Barnes. I met them at RAINBOWfest in Chicago and bought *CoCo Max III* from them, and a Disto Super Controller 2 from the Disto booth. The controller wouldn't work for me. (Disto had been recommended to me by Ed and Dave of Second City.) I tried to find the trouble — including changing the EPROM — to no avail.

Then I called Second City, and Ed had Dave Barnes call me. After about an hour and a half on the phone, we got the controller working with my 1.2 DOS. The jumpers and the book were wrong. Thanks to Ed and Dave, I am up and running now.

*George L. Schneeweiss
Chicago, IL*

Hard Drive Help

Editor:

First, I would like to thank Chris Burke of Burke & Burke for his help getting me going with my hard drive. It seems that OS-9 Level II is hard coded, so that whenever it sees $\backslash H0$ in the boot strap, it goes to the hard drive to finish booting. This is fine as long as you already have your hard drive formatted and the CMDS directory copied to it. If you have just gotten a hard drive, set it up as $\backslash A0$ until you get it formatted and CMDS copied, then you can change it back to the $\backslash H0$ and will have no problems.

*Robert J. Grubb
Gallipolis, OH*

A New Subscriber

Editor:

I have used CoCos for over 10 years. Today is the first day I have seen your magazine. Ladies and gentlemen, I am duly impressed. My masters degree is in comput-

er science (specifically in software engineering), but believe me, if I knew anything beneficial to your company, I would be asking for a job in a second! Maybe I should get a second degree?

It's obvious you put a lot of effort into this product. I'm proud to be your next subscriber. Good work!

*T. Riley
President, Riley Programming
Ames, IA*

PEN PALS

• I am 11 years old and looking for a pen pal about my age, especially girls, but guys are welcome also. I have a CoCo 3, FD 502 disk drive, and other accessories. All letters are guaranteed to be answered.

*Mike Miller
c/o Greg Miller
P.O. Box 55
Somersville, CT 06072*

• I am 15 years old and would really like some pen pals. I have a CoCo 2 and 3, a CCR-82 cassette recorder, a disk drive, CGP-115 printer and a DMP-106 printer.

*Sir Fred Patrick Hooper
Rt. 1, Box 370
Stonewall, TX 78571*

• I am 11 years old and own a CoCo 2, disk drive, cassette recorder and OS-9. I would like to correspond with someone who knows about how to do things in Adventures, asking questions about them, or just talking about anything. I'll answer as many letters as I can, as soon as they get to me.

*Andrew Yarrows
26 Briggs St.
Easthampton, MA 01027*

• I am interested in amateur radio operators using the CoCo. I have a CoCo I and 2, MC-10, FD 502 disk drive and a DMP-130A printer. I would like to exchange ideas and other information about this hobby.

*Gene Chambers
2221 Lovvorn Rd.
Carrollton, GA 30117*

• I would like to get in touch with all European CoCo 3 users — we can't be the only ones with this beautiful machine out here. We could exchange the latest information and help each other.

*Peter Tutelaers
Stryperstraak 50A
5595 GD Leende
The Netherlands*

• I am a 15-year-old boy and have a CoCo 2 with one single-sided drive. I would like to have pen pals anywhere in the world, especially North America.

*Carlos Augusto A.C. Junior
Rua Marques de Valenca
77 Casa 2
Rio de Janeiro-RJ-Brazil
CEP:20550*

BULLETIN BOARD SYSTEMS

• The Kansas Konnection BBS is now up and running daily from 10 p.m. to 7 a.m. Central time. We are running a *CoBBS* system and feature CoCo downloads and uploads, message bases, want ads and more. Coming soon . . . *Galactic Conflict!* KK-BBS runs at 300/1200 baud. Please call the KK-BBS at (913) 738-5613.

*Gary N. McCarty
215 E. 15th
Beloit, KS 67420*

• The K-Board in Gloucester, Va., welcomes your call. It is a *CoBBS* system, online 24 hours. K-Board is a 300/1200 baud board using three single-sided drives and one RAM disk. Call (804) 693-6151.

*William Keller
Rt. 1, Box 616
Gloucester, VA 23061*

• The Tandy Terminal BBS is online 24 hours/7days at (314) 966-8653 for all your CoCo 2 and 3 needs. We are running at 8-bits and no parity. To get connected, press the spacebar. We are running at 300/1200/2400 baud on a 512K CoCo 3 with two double-sided drives. Online games such as *Galactic Conflict* are available to play, and there are a number of downloads changed weekly.

*Thomas J. Wyrick
519 Meadow Creek Lane
St. Louis, MO 63122*

• The Golden Kingdom RBBS has been up and running for nearly a year now. Although it is an *all* computer IBM system, I operate a CoCo conference (J;COC0) in the main menu. We have lots of public domain programs for downloads (pictures, games, utilities and OS-9) and a message base with bulletins. The number is (604) 562-1664. Supporting 3/12/24/9600 baud with no parity, 8-bits, 1 stop bit, 24 hours, 7 days a week.

*Ross Evans
P.O. Box 2981
Prince George, B.C.
Canada V2N 4T7*

THE RAINBOW welcomes letters to the editor. Mail should be addressed to: Letters to Rainbow, The Falsoft Building, P.O. Box 385, Prospect, KY 40059. Letters should include the writer's full name and address. Letters may be edited for purposes of clarity or to conserve space.

Letters to the editor may also be sent to us through our Delphi CoCo SIG. From the CoCo SIG> prompt, type RAI to take you into the Rainbow Magazine Services area of the SIG. At the RAINBOW> prompt, type LET to reach the LETTERS> prompt and then select Letters for Publication. Be sure to include your complete name and address.

Word Power 3.1

(The Ultimate Word Processor for the CoCo 3)

Power Unleashed! Unlike other word-processors, Word Power 3.1 is written from scratch for the CoCo 3. It bridges the gap between "what is" and "what should be" in word-processors. No other word processor offers such a wide array of features that are so easy to learn and use.

DISPLAY

The 80-column display with true lowercase lets you view the full width of a standard page. All prompts are displayed in plain English in neat colored windows (see display above). The current column number, line number, page number and percentage of free memory is displayed on the screen at all times. The program even displays the bottom margin perforation so you know where one page ends and the other begins. You can also change foreground/background color of screen and select menu and carriage return colors to suit your needs! Carriage returns can be visible or invisible. Word Power 3.1 runs at double clock speed and can be used with RGB/composite/monochrome monitors as well as TV.

AVAILABLE MEMORY

No other word processor gives you so much memory. Word Power 3.1 gives you over 72K on a 128K machine and over 450K on a 512K machine to store text.

EDITING FEATURES

Word Power 3.1 has one of the most powerful and user-friendly full-screen editors with word-wrap. All you do is type. Word Power 3.1 takes care of the text arrangement. It even has a built-in Auto-Save feature which saves the current text to disk at regular intervals; so you know that your latest version is saved to disk. Here are some of the impressive editing features of Word Power 3.1:

Insert/Overstrike Mode (Cursor style changes to indicate mode); OOPS recall during delete; Type-ahead buffer for fast typers; Key-repeat (adjustable) and Key-click; Four-way cursor control and scrolling; Cursor to beginning of text, end of text, beginning of line, end of line, top/bottom of screen, next/previous word; Page up/down; Delete character, previous/next word, beginning/end of line, complete line, text before and after cursor; Locate/Replace with wild-card search with auto/manual replace; Block Mark, Unmark, Copy, Move and Delete; Line Positioning (Left/Center/Right); Set/Reset 120 programmable tab stops; Word count. Define left, right, top and bottom margins and page length. You can also highlight text (underline— with on-screen underlining, bold, italics, superscripts, etc). Word Power 3.1 even has a HELP screen which can be accessed any time during edit.

MAIL-MERGE

Ever try mailing out the same letter to 50 different people or sending out several resumes? Could be quite a chore. Not with Word Power 3.1. Using this feature, you can type a letter, follow it with a list of addresses and have Word Power 3.1 print out personalized letters. It's that easy!

SAVING/LOADING TEXT

Word Power 3.1 creates ASCII format files which are compatible with almost all terminal, spell-checking and other word-processing programs. It allows you to load, save, append and kill files and also to create and edit Basic, Pascal, C and Assembly files. You can select files by simply cursoring through the disk directory. Supports double-sided drives and various step rates.

PRINTING

Word Power 3.1 drives almost any printer (DMP series, EPSON, GEMINI, OKIDATA, etc). Allows print options such as baud rates, line spacing, page pause, partial print, page numbers, page number placement, linefeed option, multi-line headers/footers, right justification and number of copies (see display above). The values for these parameters and the margins can be changed anytime in the text by embedding Printer Option Codes. Word Power 3.1 has the WHAT YOU SEE IS WHAT YOU GET feature which allows you to preview the text on the screen as it will appear in print. You can see margins, page breaks, justification and more.

SPELLING CHECKER

Word Power 3.1 comes with a 20,000 word spelling checker/dictionary which finds and corrects mistakes within your text. You can add words to or delete from the dictionary or create a dictionary of your own.

PUNCTUATION CHECKER

This checker will proofread your text for punctuation errors such as capitalization, spaces after periods/commas, double words and much more. It's the perfect addition to any word processor.

DOCUMENTATION

Writing with Word Power 3.1 is a breeze. Word Power 3.1 comes with a well-written, easy-to-comprehend instruction manual which will lead you step-by-step through the program.

Word Power 3.1 comes on an UNPROTECTED disk and is compatible with RS DOS 1.0/1.1 and ADOS. Only \$79.95.

(Word Power 3 owners can get the 3.1 version by sending proof of purchase and \$10.00 to cover the cost of shipping and the manual.)

I purchased your Word Power. It arrived in time for my 13 year old daughter to process her history fair project. Word Power was easy to use and the features beat the heck out of the other word processors we were using.

KBG Tallahassee / Florida



MICROCOM SOFTWARE
P. O. Box 214
Fairport, NY 14450
Phone (716) 223-1477

To Place Credit Card Orders Call Toll Free 1-800-654-5244 9 AM-9 PM EST 7 days a week

NY, Canada, Foreign Orders, Information, Technical Advice and Order Status call 1-716-223-1477

All orders within Continental US shipped by UPS 2nd Day Air at no extra charge.

VISA, MC, AMEX, Check, MO. No CODs. Please add \$3.00 S&H (USA & Canada), other countries \$5.00 S&H. NYS residents please add sales tax.





Some Post-RAINBOWfest Reflections

One of the things I love about the Color Computer market is its innovation. That was evident at RAINBOWfest more than ever, and it keeps showing up as more and more people begin dipping into what is rightly considered the best home and small-business computer system in the world!

I'd like you to take just five minutes to page through this issue of THE RAINBOW. Maybe you will note, as I have, that a number of new start-up companies are coming into the CoCo arena. Yes, we sometimes bemoan the fact that some of the larger software houses do not write (or adapt) programs for the Color Computer (except when they sell directly to Tandy), but the truth of the matter is that it has never been the big companies which have made this market a success.

Over the past several months we have seen more and more smaller firms take a fling at the Color Computer market. According to an informal survey I conducted just the other day, they are very pleased with their results so far. This has always been the hallmark of the CoCo market — new and innovative products from people who are interested and care about their products and the people who buy them.

And, because of those people, there are always new mountains to climb, new areas to explore for all of us. We're really fortunate to be able to have a computer that attracts the kind of innovative people who make the CoCo a continuing source of discovery.

A number of the "old hands" are out there innovating, as well. I'm going to mention one of them here: Bill Vergona of Cer-Comp, simply because Bill's is an interesting story.

Bill has been in the Color Computer market longer than just about anyone. He's one of the finest technical types we have, and he's written some excellent software to do the kind of technical things that technical types love — looking at bits and bytes and the like.

COCO 3 UTILITIES GALORE

(All utilities support 40/80 columns for CoCo 3)
(CoCo 2 versions are available for most utilities)



SUPER TAPE/DISK TRANSFER



• Disk-to-Disk Copy (1-3 passes) • Tape-to-Disk Copy • Tape-to-Disk Automatic Relocate • Disk-to-Tape Copy • Tape-to-Tape Copy
Copies Basic/ML programs and DATA files. CoCo 1, 2 & 3. 32K Disk System (Disk to Disk Copy requires 64K). Disk Only **\$24.95**

CoCo CHECKER

Something possibly wrong with your CoCo? CoCo Checker is the answer! Will test your ROMs, RAMs, Disk Drives & Controller, Printer, Keyboard, Cassette, Joysticks, Sound, PIAs, VDG, Internal Clock Speed, Multi-pak Interface and more! **\$24.95**

DISK UTILITY 2.1A

A multi-featured tool for USER FRIENDLY disk handling. Utilize a directory window to selectively sort, move, rename & kill file entries. Lightning fast Disk I/O for format, copy & backup. Single execution of both Basic & ML programs 64 K DISK **\$29.95** NOW also CoCo III compatible! Upgrade only **\$15** w/proof of purchase.

COCO NEWSROOM

Now available for the CoCo III! You can design your own newspaper with Banner Headlines/6 articles using sophisticated Graphics, Fonts and Fill Patterns. Comes with 22 fonts & 50 pictures! Over 140K of code. Disk only **\$49.95**

MAILLIST PRO

The ultimate mailing list program. Allows you to add, edit, view, delete, change, sort (by zipcode or name) and print labels. Its indispensable! Disk Only **\$19.95** (CoCo 2 version included)

DISK LABEL MAKER

Allows you to design professional disk labels! Allows elongated, normal and condensed format for text, double-strike, border creation and multiple-label printing. Its a MUST for any user with a disk drive. Disk Only **\$19.95**. Supports DMP105/110/120/130/430, GEMINI, STAR, EPSON and compatibles. (CoCo 2 version included)

COMPUTERIZED CHECKBOOK

Why bother with balancing your checkbook? Let the CoCo do it for you! Allows you to add, view, search, edit, change, delete and printout (in a table or individual entry format) checkbook entries. Updates balance after each entry. Allows files for checking, saving and other accounts. Disk Only **\$19.95** (CoCo 2 version included)

BOWLING SCORE KEEPER

An excellent utility to keep track of your bowling scores. Allows you to save scores under individuals or teams. You can edit, change, delete and compare scores. A must for anyone who wants to keep track of his or her bowling performance. Disk **\$19.95** (CoCo 2 version included).

VCR TAPE ORGANIZER

Organize your videocassettes with this program! Allows you to index cassettes by title, rating, type, play time and comments. Also allows you to sort titles alphabetically and view/print selected tapes. If you own a VCR, this program is a must. Disk Only **\$19.95** (CoCo 2 version included).

SCREEN DUMP

32, 40, 80 column text dump, PMODE 4 Graphics Dump. Single Keystroke Operation allows you to take snapshots of screens even when programs are running! Works on DMP's, Epson and Gemini. CoCo 1, 2 and 3. Disk Only **\$24.95**



HOME BILL MANAGER

Let the CoCo keep track of your bills. Allows you to enter bills under various categories and reminds you when they are due. Disk Only **\$19.95**



CALENDAR MAKER

Generate monthly calendars on your printer for any year in the 20th century. Disk Only. **\$19.95**



COCO UTIL II

(Latest Version): Transfer CoCo Disk files to IBM compatible computer. Transfer MS-DOS files to CoCo. Req. 2-Drive IBM compatible. **\$39.95**

SPIT 'N IMAGE

Makes a BACKUP of ANY disk **\$32.95**

ADOS3

Advanced Disk Operating System for CoCo 3. **\$34.95** ADOS **\$27.95**

RGB PATCH

Displays most games in color on RGB monitors. For CoCo 3 Disk **\$24.95**

OS 9 PRODUCTS

OS 9 LEVEL II OPERATING SYSTEM



Supports 512K RAM dual speed, multi-tasking, multiple windows and more! Comes with disk and complete documentation. Only **\$89.95**

MULTI-VUE

User friendly graphics interface with multiple "window" applications for Level II. Only **\$54.95**

WIZ

OS9 Level II Terminal Package with 300-19200 baud rate and windowing capability. Requires 512K and RS-232 Pack. Only **\$79.95**

DYNASTAR

Best OS-9 Editor/Word Processor/Text Formatter. Has Keyboard Macros, supports terminals & windows simultaneously, configurable, auto-indent for C/Pascal programming, mail-merge. New manual makes it easier than ever. ONLY **\$149.95**. DynSpell: **\$49.95** Both DynaStar & DynaSpell: Only **\$174.95**

DYNACALC: OS-9

Excellent spreadsheet for OS-9 users. Only **\$99.95**

PC-Xfer UTILITIES



Programs to format and transfer files to/from MS-DOS diskettes on CoCo Under OS9 Level 1 or 2. Requires SDISK or SDISK3. Only **\$44.95**

SDISK 3



Standard disk drive module replacement allows full use of 40/80 track double sided drives. Req. OS9 Level II. Only **\$29.95**

SDISK



Same as SDISK 3 except for OS9 Level I. Only **\$29.95**

OS9 LEVEL II RAMDISK

Lightning Fast Ramdisk with Auto Formatting. A must for any OS9 Level II User. Req. 512K **\$29.95**. (Only **\$14.95** with purchase of 512K Upgrade & Ramdisk!).

BOOKS

Inside OS9 Level II: **\$39.95**
Rainbow Guide To OS9 Level II: **\$19.95**
Rainbow Guide To OS9 Level II Disk: **\$19.95**
OS9 is a trademark of Microware and Motorola, Inc.



MICROCOM SOFTWARE

P.O. Box 214
Fairport, N.Y. 14450
Phone (716) 223-1477



All orders \$50 and above shipped by UPS 2nd Day Air within Continental US at no extra charge. No CODs. We accept Visa, MC, Amex, Check or MO. Please add \$3.00 S&H (USA/Canada). Other countries \$5.00 S&H. NYS residents please add sales tax.

To Place Credit Card Orders, Call Toll Free 1-800-654-5244

NY, Canada, Foreign Orders, Information, Technical Advice and Order Status call 1-716-223-1477

At RAINBOWfest Bill debuted a new offering, *Window Master*, which is quite a departure for him. Briefly, it is a windowing interface for the CoCo 3 that runs under the "regular" operating system, not OS-9.

I looked at it hurriedly while everyone, including Bill, was setting up. I try to stop by each booth at some point during the course of a show, but I had a hard time getting to Bill's at Chicago because there were lots and lots of people.

Bill seemed a little tired. Once the show was over, I found out why. Bill said he had literally been up for 36 hours beforehand, cleaning up the final code for *Window Master*. It ran smoothly at the show, of course, for Bill is a meticulous programmer. We talked about things late that Sunday, and I pointed out to Bill that *Window Master* was really his first "non-techie" program. He agreed.

As I write this, Bill is busy condensing his code to get the program to run in less than 512K. I am sure he will. And I am sure you will be interested in the product if you have a CoCo 3.

My only point to all this is that you find all sorts of surprises at RAIN-

BOWfest and in the pages of THE RAINBOW. As I mentioned above, I am happy to see new players in the field, and I am also so very pleased to see others, like Bill Vergona, innovating and coming out with new products, new ideas and new concepts.

"A number of new start-up companies are coming into the CoCo arena."

It's what makes this Color Computer market so dynamic.

* * *

You may have noticed a difference when you got this month's issue of THE RAINBOW. We've gone from the paper wrapper we have been using to protect your favorite computer magazine in the mail, to a polybag. The polybag is tougher and allows us to place what are

known as "outserts" in the magazine as well.

An "outsert," which I guess is the opposite of an "insert," lets us include things inside the polybag without having to go to the expense of binding it inside the magazine itself.

One of the changes is that you'll be getting an "outsert" notice when your subscription is about to run out rather than the notice printed on the paper wrapper. Another is that — we hope — some of our advertisers will be able to take advantage of the polybag and its "outserting" capability to include catalogs and the like inside the bag. It makes it easier for us to handle and less expensive for the advertiser to produce.

Finally, you may have noticed your favorite computer magazine "on the rack" at Waldenbooks, Cole's Books and several other locations. We've always been carried by a great number of Waldenbooks' stores, but now we will be in 1,100 of them nationwide. Not only will THE RAINBOW be in the stores, but we'll be on a special rack designed especially for computer magazines. Go by and see!

— Lonnie Falk



500 POKES, PEEKs, 'N EXECs

FOR THE TRS-80 COCO
NEVER BEFORE has this information of vital significance to a programmer been so readily available to everyone. This book will help you 'GET UNDERNEATH THE COVER' of the Color Computer and develop your own HI-QUALITY Basic and ML programs. SO WHY WAIT??

This 80-page book includes POKES, PEEKs and EXECs to:

- ★ Autostart your basic programs
 - ★ Disable Color Basic/ECB/Disk Basic commands like LIST, LLIST, POKE, EXEC, CSAVE(M), DEL, EDIT, TRON, TROFF, PCLEAR, DLOAD, RENUM, PRINT USING, DIR, KILL, SAVE, LOAD, MERGE, RENAME, DSKINI, BACKUP, DSKI\$, and DSKO\$.
 - ★ Disable BREAK KEY, CLEAR KEY and RESET BUTTON.
 - ★ Generate a Repeat-key.
 - ★ Transfer ROMPAKS to tape (For 64K only).
 - ★ Set 23 different GRAPHIC/SEMIGRAPHIC modes
 - ★ Merge two Basic programs.
 - ★ AND MUCH MUCH MORE!!!
- COMMANDS COMPATIBLE WITH
16K/32K/64K/COLOR BASIC/ECB/DISK
BASIC SYSTEMS and CoCo 1, 2, & 3.

ONLY \$16.95

SUPPLEMENT to 500 POKES, PEEKs 'N EXECs

ONLY \$9.95

200 additional Pokes, Peek's 'n Execs to give you MORE PROGRAMMING POWER. Includes commands for:

- Rompak Transfer to disk
- PAINT with 65000 styles!
- Use of 40 track single/double sided drives with variable step-rates
- High-Speed Cassette Operation
- Telewriter 64[®], Edtasm+[®] and CoCo Max[®] Enhancements
- Graphics Dump (for DMP printers) & Text Screen Dump
- AND MUCH MUCH MORE!
- 500 POKES, PEEKs 'N EXECs is a prerequisite

300 POKES PEEKs 'N EXECs FOR THE COCO III

Get more POWER for your CoCo III. Includes commands for:

- 40/80 Column Screen Text Dump
- Save Text/Graphics Screens to Disk
- Command/Function Disables
- Enhancements for CoCo 3 Basic
- 128K/512K Ram Test Program
- HPRINT Character Modifier
- AND MANY MORE COMMANDS



ONLY \$19.95

"MUST" BOOKS

UNRAVELLED SERIES: These books provide a complete annotated listing of the BASIC/ECB and DISK ROMs.

- EXTENDED COLOR BASIC UNRAVELLED: \$39.95
- DISK BASIC UNRAVELLED: \$19.95
- BOTH UNRAVELLED BOOKS: \$49.95
- SUPER ECB (CoCo3) UNRAVELLED: \$24.95
- ALL 3 UNRAVELLED BOOKS: \$59.95
- COCO 3 SERVICE MANUAL \$39.95
- COCO 2 SERVICE MANUAL: \$29.95
- INSIDE OS9 LEVEL II \$39.95
- RAINBOW GUIDE TO OS9 LEVEL II ON COCO 3: \$19.95
- RAINBOW GUIDE TO OS9 II DISK: \$19.95
- BASIC PROGRAMMING TRICKS \$12.95
- COCO 3 SECRETS REVEALED: \$19.95
- ASSEMBLY LANGUAGE PROGRAMMING*: \$18.00
- ADDENDUM FOR COCO 3: \$12.00
- UTILITY ROUTINES VOL 1 BOOK: \$19.95



GAMES (Disk Only) (CoCo 1, 2, & 3 except where mentioned)

- WILD WEST (CoCo 3 Only) \$24.95
- VEGAS SLOTS (CoCo 3 Only) \$29.95
- VEGAS GAME PACK: \$24.95
- FLIGHT 16: \$34.95
- IN QUEST OF STAR LORD (Animated Graphics Adventure: CoCo 3): \$34.95
- WHITE FIRE OF ETERNITY: \$19.95
- PYRAMIX (Cubix for CoCo 3): \$24.95
- P-51 MUSTANG SIMULATION: \$34.95
- WORLDS OF FLIGHT: \$34.95
- KUNG FU DUDE: \$24.95
- APPROACH CONTROL SIMULATION: \$34.95
- TREASURY PACK #1: Lunar Rover Patrol, Cubix, Declathon, Qix, Keys of Wizard, Module Man, Pengon, Space Wrek and Roller Controller. Only \$29.95
- TREASURY PACK #2: Lancer, Ms. Gobbler, Froggie, Madness and Minotaur, Ice Castles, Galagon, Devious and Syzygy. Only \$29.95
- SPACE PACK: Color Zap, Invaders, Planet Invasion, Space Race, Space War, Galax Attax, Anaroid Attack, Whirlybird, Space Sentry & Storm Arrows. Only \$29.95

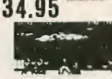
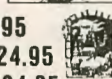

COCO GRAPHICS DESIGNER

Signs Greeting Cards Banners

The CoCo Graphics Designer allows you to create beautifully designed Greeting Cards, Signs and Banners for holidays, birthdays, parties, anniversaries and other occasions. Comes with a library of pre-drawn pictures. Also includes utilities which allow you to create your own character sets, borders and graphic pictures. Requires a TRS-80 COLOR COMPUTER I, II OR III OR TDP-100 with a MINIMUM OF 32K, ONE DISK DRIVE and a PRINTER. compatible with DISK BASIC 1.0/1.1, ADOS 1.0/1.1 AND JDOS.

Supports the following printers: DMP 100/105/110/130/430, CGP 220, EPSON RX/FX, GEMINI 10X, SG-10, NX-10 & OKIDATA. **DISK \$29.95**

PICTURE DISK #1: 100 more pictures for CGD: \$14.95

FONT DISK #1: 10 extra fonts! \$19.95

FONT DISK #2: 10+ extra fonts \$19.95

CAR SIGN DESIGNER

Create distinctive bright yellow diamond shaped car signs. Includes 2 reusable clear plastic sign holders with suction cups, and 50 sheets of bright yellow fanfold paper. **Disk Only \$29.95**

COLORED PAPER PACKS \$24.95

COCO MAX III (with hi-res interface): \$79.95

COCO MAX II: Disk \$77.95 Tape \$67.95

MAX PATCH An excellent software patch to run COCO MAX II on COCO III. Req. RS Hi-res Joystick Interface. No chip replacements or soldering. Disk only \$24.95

COLOR MAX 3 DELUXE: \$69.95

COLOR MAX 3: \$59.95

Telewriter-64: Best Word Processor for CoCo 1 & 2 (Cas) \$47.95 (Disk) \$57.95

TW-80: 80 Column Display & more features for TW-64. CoCo 3 Disk \$39.95

TELEFORM: Mail Merge & Form Letters for TW-64. \$19.95

Autoterm: Superb Terminal Program. Works with any modem! (Cas) \$29.95 (Disk) \$39.95

Pro Color File *Enhanced*: Multi-feature Database \$59.95 Sidewise: \$24.95

Pro-Color Dir: \$24.95

EDT/ASM 640: Best Disk Based Editor-Assembler for CoCo \$59.95 (Specify CoCo 1, 2 or 3)

THE SOURCE: Best Disassembler for CoCo \$34.95

THE SOURCE III: \$49.95

CBASIC: Most powerful Basic Program Compiler \$149.95 (Specify CoCo 1, 2 or 3)

DYNACALC (COCO 1, 2 & 3): \$99.95

MICROCOM SOFTWARE
P.O. Box 214
Fairport, N.Y. 14450
Phone (716) 223-1477

All orders \$50 and above shipped by UPS 2nd Day Air within Continental US at no extra charge. No CODs. We accept Visa, MC, Amex, Check or MO. Please add \$3.00 S&H (USA/Canada). Other countries \$5.00 S&H. NYS residents please add sales tax.

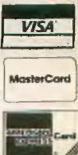

To Place Credit Card Orders, Call Toll Free 1-800-654-5244 9 AM - 9 PM EST 7 days a week
NY, Canada, Foreign Orders, Information, Technical Advice and Order Status call 1-716-223-1477

How To Read Rainbow

When we use the term CoCo, we refer to an affectionate name that was first given to the Tandy Color Computer by its many fans, users and owners.

The BASIC program listings printed in THE RAINBOW are formatted for a 32-character screen — so they show up just as they do on your CoCo screen. One easy way to check on the accuracy of your typing is to compare what character “goes under” what. If the characters match — and your line endings come out the same — you have a pretty good way of knowing that your typing is accurate.

We also have “key boxes” to show you the *minimum* system a program needs. But, *do* read the text before you start typing.

Finally, the little disk and/or cassette symbols on the table of contents and at the beginning of articles indicate that the program is available through our RAINBOW ON DISK or RAINBOW ON TAPE service.

Using Machine Language

The easiest way to “put” a machine language program into memory is to use an editor/assembler, a program you can purchase from a number of sources. All you have to do, essentially, is copy the relevant instructions from THE RAINBOW’s listing into CoCo.

Another method of putting an ML listing into CoCo is called “hand assembly” — assembly by hand, which *sometimes* causes problems with ORIGIN or EQUATE statements. You ought to know something about assembly to try this.

Use the following program if you want to hand-assemble ML listings:

```
10 CLEAR200, &H3F00: I=&H3FB0
20 PRINT "ADDRESS:"; HEX$(I);
30 INPUT "BYTE"; B$
40 POKE I, VAL("&H"+B$)
50 I=I+1:GOTO 20
```

This program *assumes* you have a 16K CoCo. If you have 32K, change the &H3F00 in Line 10 to &H7F00 and change the value of I to &H7FB0.

OS-9 and RAINBOW ON DISK

The OS-9 side of RAINBOW ON DISK contains two directories: CMDS and SOURCE. It also contains a file, `read.me.first`, which explains the division of the two directories. The CMDS directory contains executable programs and the SOURCE directory contains the ASCII source code for these programs. BASIC09 programs will only be offered in source form so they will only be found in the SOURCE directory.

OS-9 is a very powerful operating system. Because of this, it is not easy to learn at first. However, while we can give specific instructions for using the OS-9

programs, you will find that the OS-9 programs will be of little use unless you are familiar with the operating system. For this reason, if you haven’t “learned” OS-9 or are not comfortable with it, we suggest you read *The Complete Rainbow Guide to OS-9* by Dale Puckett and Peter Dibble.

The following is not intended as a course in OS-9. It merely states how to get the OS-9 programs from RAINBOW ON DISK to your OS-9 system disk. Use the procedures appropriate for your system. Before doing so, however, boot the OS-9 operating system according to the documentation from Radio Shack.

- 1) Type `load dir list copy` and press ENTER.
- 2) If you have only one disk drive, remove the OS-9 system disk from Drive 0 and replace it with the OS-9 side of RAINBOW ON DISK. Then type `chd/d0` and press ENTER. If you have two disk drives, leave the system master in Drive 0 and put the RAINBOW ON DISK in Drive 1. Then type `chd/d1` and press ENTER.
- 3) List the `read.me.first` file to the screen by typing `list read.me.first` and pressing ENTER.
- 4) Entering `dir` will give you a directory of the OS-9 side of RAINBOW ON DISK. To see what programs are in the CMDS directory, enter `dir cmds`. Follow a similar method to see what source files are in the SOURCE directory.
- 5) When you find a program you want to use, copy it to the CMDS directory on your system disk with one of the following commands:

One-drive system: `copy /d0/cmds/ filename /d0/cmds/ filename -s`

The system will prompt you to alternately place the source disk (RAINBOW ON DISK) or the destination disk (system disk) in Drive 0.

Two-drive system: `copy /d1/cmds/ filename /d0/cmds/ filename`

Once you have copied the program, you execute it from your system master by placing that disk in Drive 0 and entering the name of the file.

The Rainbow Seal



The Rainbow Certification Seal is our way of helping you, the consumer. The purpose of the Seal is to certify to you that any product that carries the Seal has actually been seen by us, that it does, indeed, exist and that we have a sample copy here at THE RAINBOW.

Manufacturers of products — hardware, software and firmware — are encouraged by us to submit their products to THE RAINBOW for certification.

The Seal is not a “guarantee of satisfaction.” The certification process is different from the review process. You are encouraged to read our reviews to determine whether the product is right for your needs.

There is absolutely no relationship between advertising in THE RAINBOW and the certification process. Certification is open and available to any product per-

taining to CoCo. A Seal will be awarded to *any* commercial product, regardless of whether the firm advertises or not.

We will appreciate knowing of instances of violation of Seal use.

Rainbow Check Plus

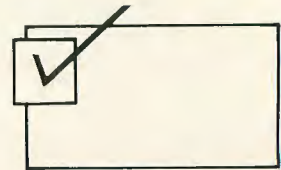

The small box accompanying a program listing in THE RAINBOW is a “check sum” system, which is designed to help you type in programs accurately.

Rainbow Check PLUS counts the number and values of characters you type in. You can then compare the number you get to those printed in THE RAINBOW. On longer programs, some benchmark lines are given. When you reach the end of one of those lines with your typing, simply check to see if the numbers match.

To use Rainbow Check PLUS, type in the program and save it for later use, then type in the command RUN and press ENTER. Once the program has run, type NEW and press ENTER to remove it from the area where the program you’re typing in will go.

Now, while keying in a listing from THE RAINBOW, whenever you press the down arrow key, your CoCo gives the check sum based on the length and content of the program in memory. This is to check against the numbers printed in THE RAINBOW. If your number is different, check the listing carefully to be sure you typed in the correct BASIC program code. For more details on this helpful utility, refer to H. Allen Curtis’ article on Page 21 of the February 1984 RAINBOW.

Since Rainbow Check PLUS counts spaces and punctuation, be sure to type in the listing exactly the way it’s given in the magazine.

```
10 CLS:X=256*PEEK(35)+178
20 CLEAR 25,X-1
30 X=256*PEEK(35)+178
40 FOR Z=X TO X+77
50 READ Y:W=W+Y:PRINT Z,Y;W
60 POKE Z,Y:NEXT
70 IF W=7985 THEN 80 ELSE PRINT
  "DATA ERROR":STOP
80 EXEC X:END
90 DATA 182, 1, 106, 167, 140, 60, 134
100 DATA 126, 183, 1, 106, 190, 1, 107
110 DATA 175, 140, 50, 48, 140, 4, 191
120 DATA 1, 107, 57, 129, 10, 38, 38
130 DATA 52, 22, 79, 158, 25, 230, 129
140 DATA 39, 12, 171, 128, 171, 128
150 DATA 230, 132, 38, 250, 48, 1, 32
160 DATA 240, 183, 2, 222, 48, 140, 14
170 DATA 159, 166, 166, 132, 28, 254
180 DATA 189, 173, 198, 53, 22, 126, 0
190 DATA 0, 135, 255, 134, 40, 55
200 DATA 51, 52, 41, 0
```

SUPER 88 UTILITIES For Only \$88

\$440 Value!

40K FOR CASSETTE PROGRAMS: #200
 40K FOR DISK BASIC PROGRAMS: #201
 ALPHA-DIR: Alphabetize DIR's #202
 APPOINTMENT CALENDAR: #203
 ASCII FILE UTILITY: #204
 AUTOMATIC DISK BACK-UP: Req. 2 drives #205
 AUTOMATIC 5 MIN. CASSETTE SAVE: #206
 AUTOMATIC 5 MIN. DISK SAVE: #207
 AUTO DIR BACK-UP: No more FS errors #208
 BASE CONVERTER: #209
 BANNER MAKER: 7" high letters #210
 BASIC SEARCH: Search for a string #211
 BORDER MAKER: 255 border styles #212
 CASSETTE LABEL MAKER: DMP's only #213
 CLOCK: Keeps time as you program #214
 COMMAND KEYS: Shorthand for BASIC #215
 COMMAND MAKER: Design own commands #216
 COMMAND SAVER: Saves/recalls commands #217
 CALCULATOR: On-screen calculator #218
 CURSOR STYLES: 65535 cursor styles #219
 DISK CATALOGER: DIR's into master DIR #220
 DISK ENCRYPT: BASIC password protection #221
 DMP CHARACTER SET EDITOR: #222
 DMP SUPERSCRIPTS: Great for term papers #223
 DOS COMMAND ENHANCER: #224
 DOUBLE BANK: 64K only #225
 ENHANCED KILL: #226
 ENHANCED LLIST: Beautiful LLISTings #227
 ENHANCED TRON: #228
 ERROR LOCATOR: #229
 E-Z DISK MASTER: #230
 FAST SORT: 100 strings in 3 seconds #231
 FILE SCRAMBLER: Hide your private files #232
 FULL ERRORS: English error messages #233
 FUNCTION KEYS: Speeds prog time #234
 GRADE BOOK: Great for teachers #235
 GRAPHICS SCREEN COMPRESSION: #236
 GRAPHICS SHIFTER: #237
 GRAPHICS TYPE SETTING: 2 letter sizes #238
 GRAPHICS ZOOM: Magnify/edit graphics #239
 INPUT/OUTPUT DATA MONITOR: #240
 KEY CLICKER: Ensures input accuracy #241
 KEY SAVER: Save/recall keystrokes #242
 LAST COMMAND REPEATER: #243

LINE COPY: Copy BASIC lines #244
 LINE CROSS-REFERENCE: #245
 LIST/DIR PAUSE: No more fly-bys #246
 LOWER CASE COMMANDS: #247
 MASS DISK INITIALIZATION: #248
 MESSAGE ANIMATOR: Great billboard #249
 METRIC CONVERSION: #250
 ML/BASIC PROGRAM MERGE: #251
 ML TO DATA CONVERTER: #252
 MULTIPLE CHOICE TEST MAKER: #253
 NUMERIC KEYPAD: #254
 ON BREAK GOTO COMMAND: #255
 ON ERROR GOTO COMMAND: #256
 ON RESET GOTO COMMAND: #257
 PHONE DIRECTORY: #258
 PAUSE CONTROL: Put progs on hold #259
 PRINTER TO SCREEN: #260
 PRINTER TUTORIAL: #261
 PROGRAM PACKER: For BASIC progs #262
 PURCHASE ORDER MAKER: #263
 RAMDISK: In-memory disk drive #264
 REPLACE/FIND STRINGS: #265
 REVERSE VIDEO (GREEN): #266
 REVERSE VIDEO (RED): #267
 RAM TEST: Checks your RAM #268
 ROM SWITCHER: #269
 SIGN MAKER: Runs on any DMP #270
 SINGLE STEPPER: Great de-bugger #271
 SPEEDUP TUTORIAL: #272
 SPOOLER: Speed up printouts #273
 SUPER INPUT/LINE INPUT: #274
 SUPER COMMAND KEYS: #275
 SUPER COPY: Copy multiple files #276
 SUPER EDITOR: Scroll BASIC progs #277
 SUPER PAINT: 65535 patterns #278
 SUPER REPEAT: Repeat key #279
 SUPER SCROLLER: View scrolled lines #280
 TAB/SHIFT LOCK KEYS: #281
 TAPE ENCRYPT: Password protect BASIC #282
 TAPE INDEX SYSTEM: For tape progs #283
 TEXT SCREEN SCROLL LOCK: #284
 TITLE SCREEN CREATOR: #285
 UNKILL: Recover KILLED disk progs #286
 VARIABLE CROSS-REFERENCE: #287

All Above Utilities Only \$88, or 1 Program \$9, 2 Programs \$16, 3 Programs \$21, 4 Programs \$24, 5 or more at \$5 each. All Programs on disk. More than 1 pro. on same disk. Documentation Included.

StarScan
by J.D. Walker



Dumps a HSCREEN2 screen to a NX-1000 Rainbow printer in 64 colors!!
Only \$19.95

NX 1000 Rainbow System

- * Star NX1000 Color Printer
- * Serial to Parallel Interface
- * Free Software: StarScan & Signs 'N Banners

Only \$299
(Include \$10 Shipping; Amex 3% extra)

COLOR SCHEMATIC DESIGNER

By Prakash Mishra

An Excellent CACD Software Package for CoCo 3. Features:

- * Runs in 640x192 at 1.8Mhz
- * Pull Down Menus
- * Keyboard/Joystk/Mouse Support
- * RGB/Comp/Monochrome Monitors
- * 72 Modifiable Symbols
- * Multiple Hi-Res Fonts
- * Multiple UNDO Command
- * Symbol Rotate/Line/Box Draw
- * Supports 3 layers of circuits
- * Complete Window Scrolling
- * Powerful Screen Print Command
- * Complete Documentation

Disk Only \$39.95



WINDOW MASTER

The hottest program for your 512K CoCo 3!! Imagine using Windows, Pull Down Menus, Buttons, Icons, Edit Fields and Mouse Functions in your Basic Programs. No need to use OS9. It uses the 640x255 (or 320x255) hires graphics mode for the highest resolution. Up to 31 windows can appear on the screen at one time. Need extra character sets? Window Master supports 5 fonts in 54 sizes!! How about an enhanced editor for Basic.? I gives you a superb Basic Editor which leaves the standard EDIT command in the cold. And don't forget that many existing Basic/ML programs will run under Window Master with little or no changes. In fact it does NOT take up any memory from Basic. Window Master has so many features that will fill 2 pages!! Don't MISS OUT on this one! Req. min 512K, 1 Disk Drive, RS Hi-Res Interface & Joystick or Mouse. Only \$69.95. Window Master & Hi-Res Interface: \$79.95.



MICROCOM SOFTWARE
P.O. Box 214
Fairport, N.Y. 14450
Phone (716) 223-1477

All orders \$50 and above (except Disk Drives) shipped by UPS 2nd Day Air within Continental US at no extra charge. No CODs. We accept Visa, MC, Amex, Check or MO. Please add \$3.00 S&H (USA/Canada). Other countries \$5.00 S&H. NYS residents please add sales tax.

No Free 2nd day shipping for Printer.

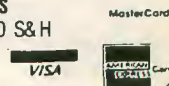

To Place Credit Card Orders, Call Toll Free 1-800-654-5244 9 AM-9 PM EST 7 days a week
NY, Canada, Foreign Orders, Information, Technical Advice and Order Status call 1-716-223-1477

Solution to last month's logic problem

The Crazy Pool Ball Explained

By Bruce W. Ronald

The problem in last month's RAINBOW was to identify which of 12 pool balls was heavier or lighter than the others. You had only three weighings on a simple balance scale, which only tells if one side is heavier than the other, to solve the problem. The program also provided you with a way to test your algorithm.

One insight into the problem is that the most you can handle on the final weighing is three, and you must know each ball's proclivity. That is, if you weigh the first six balls on the left side of the scale against the second six on the right, and the left side of the scale goes down, you know that balls 1 through 6 have a proclivity to be heavy and 7 through 12 a proclivity to be light. If you end up with three suspects, all with a heavy proclivity, you can weigh one against the other — for instance, Ball 1 versus 2. If Ball 1 goes down, it's 'X'; the same goes for Ball 2. If the scales balance, X is Ball 3.

You soon learn that the first weighing, however, must be four balls against four; no other comparison yields so much information and elimination. Weigh balls 1, 2, 3 and 4 against 5, 6, 7 and 8. If the scale balances, the solution is fairly easy. You next weigh balls 9 and 10 against 11 and Y (any ball

from the first eight that you know to be normal).

If this scale balances, Ball 12 is the deviant; weighing Ball 12 against Y determines if it is lighter or heavier. If balls 9 and 10 go down, it can only be because either 9 or 10 are heavier, or 11 is lighter; weigh 9 against 10 to finish the answer. If Ball 9 goes down, it is the "crazy" ball. Ditto for Ball 10. If this weighing balances, Ball 11 is light.

If the original weighing does not balance, we have a trickier problem. If group 1 through 4 goes down, we know that 1, 2, 3 or 4 could be heavy; or 5, 6, 7 or 8 could be light; or vice versa if group 1 through 4 goes up.

In this case the next weighing is balls 1, 2 and 5 against 3, 6 and Y. If group 1, 2, 5 drops, it can only be because 1 or 2 is heavy or 6 is light; a 1 versus 2 weighing produces the answer. If group 3, 6, Y drops, the crazy ball can only be Ball 5 (light) or Ball 3 (heavy). A weighing of one against Y produces the answer. If 1, 2, 5 and 3, 6, Y are equal, weigh Ball 7 against Ball 8. The lighter ball is the deviant. If 7 and 8 balance, the only possibility remaining is a heavy Ball 4.

Whoever dreamed up this problem originally was an evil genius! I hate to admit how many hours I spent before spotting the concept of proclivity and, finally, the trick of crossing the balls on the middle weighing. I hope you were much faster and that the program helped you prove the validity of your answer.

(Questions or comments concerning this solution may be addressed to the author at 101 Forrer Blvd., Dayton, OH 45419. Please enclose an SASE when requesting a reply.)

Bruce Ronald, an advertising copywriter, holds a bachelor's degree in speech. He has written a science fiction thriller, Our Man in Space, and the book of the musical, Dracula, Baby. He and his wife, Virginia, coauthored two prize-winning local histories of Dayton and its suburb, Oakwood — the latter on the CoCo.

DISK DRIVES

Double Sided Double Density 360 K40 Track 1/2 Ht Disk Drives for CoCo2 and 3. Buy from someone else and all you get is a disk drive. Buy from us and not only do you get a quality disk drive but also \$60 worth of disk utility software (Super Tape/Disk Transfer and Disk Tutorial) and our DISKMAX utility which allows you to use BOTH sides of our disk drives. Its like buying TWO disk drives for the price of ONE!!

Drive 0 (with J & M Controller & Cable): \$229.95 Drive 1: \$149.00

TWO 1/2 ht Drives in one case with cable & controller: \$339.95

Single Power-Supply & Case: \$59.95

Disk Drive Power Supply 'Y' Cables: \$8.95

(90 day warranty on all drives)

J&M Controller (with RSDOS): \$79.95 DISTO Super Controller: \$99.95

Mini Eprom Programmer Add-On: \$54.95 Real Time Clock & Parallel Printer Interface Add-on: \$39.95

DISTO Super Controller II: \$129.95

1 Drive Cable: \$19.95

2 Drive Cable: \$24.95

4 Drive Cable: \$39.95

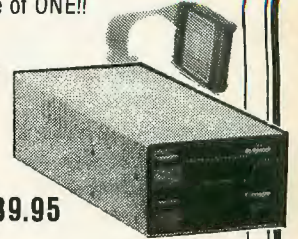

HARD DRIVE KITS

Complete with Hard Drive, WD Controller Burke Interface, Cables, Case, Power Supply, Software (OS9 & Basic) and complete instruction manual.

20 Meg Kit: \$529

30 Meg Kit: \$549

Assembled/Tested/Formatted: \$30 extra



Pl. add \$10 S&H
for drives in
US/Canada

HARD DRIVE INTERFACES

COCO XT: Use 5-120 meg drives with CoCo \$69.95. With Real Time Clock: \$99.95

HYPER IO: Allows Hard Drives use with RS-DOS. Only \$29.95

COCO XT ROM: Boots OS9 from Hard/Floppy Drives. Only \$19.95

(Multipak required for the hard drive use)

MONOCHROME MAGNAVOX

MONITOR \$99 (Cable Extra)

COMMUNICATIONS EXTRAVAGANZA

1) AVATEX 1200e MODEM: Fully Hayes compatible 300/1200 Baud, Auto-Dial/Answer/Redial (Reg \$129.95)

2) MODEM CABLE (Reg. \$19.95)

3) AUTOTERM TERMINAL SOFTWARE

4) FREE COMPUSERVE OFFER and Access Time

5) UPS 2nd DAY AIR Shipping.

ONLY \$149.95

(With AVATEX 1200hc instead of

AVATEX 1200: \$174.95)

AVATEX 2400: \$229.95



8CM515 RGB Monitor 80

17% larger screen than standard 12" monitors. RGB TTL, RGB Analog, Composite inputs. Green raster display switch. Etched faceplate. **ONLY \$294.00** Include \$12 shipping. **FREE** Magnavox cable for COCO 3 with the purchase of the monitor.

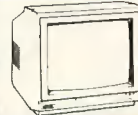

CABLES/INTERFACE

RS232 Y CABLE: Hook 2 devices to the serial port. **ONLY \$18.95**

Y CABLE: Use your Disk System with CoCo Max, DS69, etc. **ONLY \$24.95**

15' PRINTER/MODEM EXTENDER CABLE: **ONLY \$16.95**

MODEM CABLE: 4 pin to DB 25: **\$19.95**

15" MULTIPAK/ROMPAK EXTENDER CABLE: **\$29.95**

3-POSITION SWITCHER: **\$37.95**

WICO TRACK BALL: **\$34.95**

RS HI-RES JOYSTICK INTERFACE: **\$11.99**

MAGNAVOX 8505/8515/8CM643 Analog

RGB Cable: **\$24.95**

CM-8 RGB Analog Ext. Cable: **\$19.95**

SONY Monitor Cable: **\$39.95**

VIDEO DRIVER: For Monochrome or Color. Specify CoCo 1 or 2. **\$34.95**

VIDEO CLEAR: Reduce TV interference. **\$19.95**

SERIAL TO PARALLEL INTERFACE: With 6 switch selectable baud rates (300-9600) Comes with all cables. **\$44.95**

EPROM

INTRONICS EPROM PROGRAMMER: Best EPROM Programmer for the CoCo. Lowest Price Anywhere. **\$137.95**

EPROM ERASER (Datarase): Fast erase of 24/28 pin EPROMs. **\$49.95**

EPROMS: 2764 - \$8.00, 27128 - \$9.00
Call for other EPROMs.

BOTH EPROM PROGRAMMER and ERASER: **\$179.95**

ROMPAK w/Blank PC Board 27xx Series: **\$12.95**

KEYBOARDS/ACCESSORIES

KEYBOARD EXTENSION CABLE: Our keyboard extender cable allows you to move your keyboard away from the computer and type with ease. You can use your existing keyboard with this cable or leave your present keyboard intact and use a second keyboard. A MUST for all CoCo Users. **ONLY \$39.95.**

Cable with CoCo II keyboard: **\$49.95 COCO 3**

KEYBOARD (includes FREE FUNCTION KEYS software value \$19.95) **\$39.95**

CoCo II keyboard: **\$19.95**

CHIPS, ETC.

Disk Basic Rom 1.1 (Needed for CoCo III) \$29.95.

6BB09E Chip: \$14.95 ECB Rom 1.1: \$29.95. Multi-Pak PAL Chip for CoCo 3 \$19.95 PAL Switcher: Now you can switch between the CoCo II and CoCo III

modes when using the Multi-Pak. You need the OLDER and NEW PAL chip for the 26-3024

Multipak. **Only \$39.95 With NEW PAL Chip \$49.95**

5 1/4" DS/DD Disks: \$0.45 each.

UPGRADES

512K UPGRADE FOR COCO III

Fast 120ns chips. Fully tested. Easy installation. No soldering. Comes with complete documentation and RAM test program on disk.



ONLY \$CALL



(With purchase of our 512K RAMDISK program below)

512K Upgrade without chips \$44.95

512K RAMDISK \$24.95

Have 2 superfast RAMDISKS & a print spooler.

64K Upgrade for 26-3134 A/B CoCo II: \$39.95

64K Upgrade for CoCo I's, CoCo II's with Cat

#26-3026/7, 26-3134 & 26-3136: \$29.95

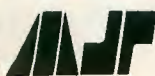

MICROCOM SOFTWARE

P.O. Box 214

Fairport, N.Y. 14450

Phone (716) 223-1477

All orders \$50 and above (except Disk Drives) shipped by UPS 2nd Day Air within Continental US at no extra charge. No CODs. We accept Visa, MC, Amex, Check or MO. Please add \$3.00 S&H (USA/Canada). Other countries \$5.00 S&H. NYS residents please add sales tax.

No Free 2nd Day Shipping for Monitors.



To Place Credit Card Orders, Call Toll Free 1-800-654-5244 9 AM - 9 PM EST 7 days a week

NY, Canada, Foreign Orders, Information, Technical Advice and Order Status call **1-716-223-1477**

Max-10™

COLORWARE

BLINDING SPEED

Max-10 is entirely written in machine language. Its speed will amaze you.

SLEEK

A lot of word processors "do the job", but Max-10 makes word processing fun.

INTUITIVE

Max-10 is so well designed you can use it without reading the manual.

FUN

Max-10 is actually fun to use, which is quite an achievement for a word processor.

FORMAT

Unlimited choice of right or left alignment, centering, and line spacing. Screen is updated immediately to show exact effects of changes.

PAGE NUMBERING

On-screen page number helps you find your place.

PRINTERS

Max-10 currently works with the following printers: DMP-105, DMP-106, DMP-130, Epson MX,RX,FX,LX and compatible, Gemini 10 series, CGP-220, and OKI-92.

SUPERB FILE SUPPORT

Max-10 menus let you load files without typing anything: simply point and click.

FILE COMPATIBILITY

Max-10 can import files from your outmoded word processor.

GRAPHICS

Mix text and graphics on your page. Pictures can be created by CoCo Max, the DS-69 Digitizer, or any graphics editor.

FIT IT IN

Pictures can be shrunk and stretched in both directions to fit the page and text.

TAB STOPS & MARGINS

The rulers make tabs and margins easy to see, use, and change.

Max-10 Specifications: variable line length; right, left, top and bottom margins; word wrap; undo; page numbering; set starting page; left and right justification; centering; margins and centering can be changed anywhere in the document; variable line spacing; programmable headers and footers (with centering, graphics, etc.); type ahead; key repeat; key click; scroll up and down; jump to any point in document; ASCII file output for compatibility; disk directory; kill files; bold, italic, underline, superscript and subscript type styles; wordwrap; block cut, copy, move; global search and replace; paragraph indent; clipboard; merge; show file (on disk); free memory display, page count, paragraph count, word count; graphics can be resized and moved; multiple fonts; error recovery and more!

BY DAVE STAMPE

Author of CoCo Max III, the best and most acclaimed CoCo 3 Graphics Editor.

GRAPHICS

Max-10 can import pictures stored in the following formats: CoCo Max I,II,III, MGE, MGF, 5 level DS-69, as well as any standard PMODE 4, HSCREEN 2 or 3 picture.



THE DAZZLING WORD PROCESSOR AND DOCUMENT CREATOR FOR THE COCO 3

PULL DOWN MENUS

All Max-10 Functions can be easily accessed through the six pull-down menus. There are no commands to learn.

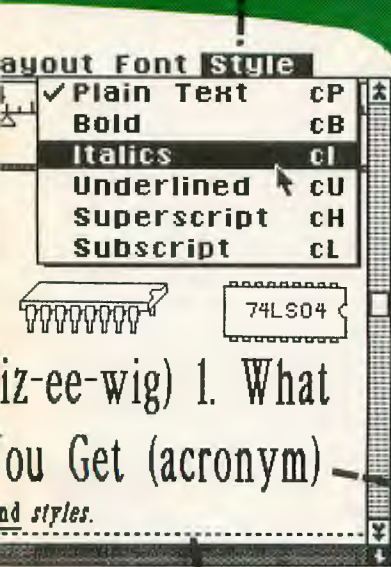

WYSIWYG!

What You See Is What You Get. Max-10 is the only CoCo word processor with graphics where the printout looks exactly like the screen (Macintosh style).

UNDO

The undo feature lets you change your mind even AFTER you make a drastic change, such as a "block delete".

SCROLL BOX

Point and click for lightning fast access to any point in the entire document.

MORE FONTS

Max-10 features 20 different fonts (styles and sizes). It goes well beyond your printer's built in character sets.

PAGE BREAK

Dotted lines on the screen show where pages begin and end. No more surprises at printing time.

TOTAL CONTROL

Any number of available character styles and sizes can be mixed on the same line.

FULL JUSTIFICATION

Proportionally spaced characters let you create text that looks really nice. No more squished "M"s and oversized "I"s.

HEADERS & FOOTERS

These are super easy to add and edit. They can even include graphics and pictures!

SYSTEM REQUIREMENTS

Any CoCo 3 (128K or 512K) with at least 1 Disk Drive.
Mouse or joystick.
Monochrome, RGB or Composite monitor.

COLORWARE

A division of Sigma Industries, Inc.

Why Max-10?

Most of you already have an "adequate" word processor, so why did we spend considerable time and effort to create Max-10?

Because you asked for it. CoCo Max made graphic creation fun. It is fast and feature loaded, yet amazingly easy to use. You wanted your word processor to be as friendly, forgiving, and amazing as CoCo Max. We couldn't do it on the CoCo 1 or 2, but with the advanced CoCo 3 graphics, the word processor you always wanted is here: Max-10

Max-10 is not just a word processor. It gives you letter styles and sizes that your printer doesn't have. It lets you mix graphics and pictures in your text for a professional looking output.

Additionally, the screen shows exactly what your output will look like. Text is in the size and style that it will print. Page breaks, line length and spacing are clearly shown. No more hoping that the text will fit, no more guessing at type styles, no more messing with printer codes, no more cryptic commands to memorize, and best of all, the undo feature lets you make a mistake and still recover your text.

Max-10 makes typing easy, and you'll love the new things you can do with the best word processor ever created for the CoCo.

PRICE: \$79.95

CoCo Max III OWNERS

If you already own CoCo Max III, deduct \$10 from your order.

TO ORDER

Call (203) 656-1806 9 to 5 Eastern time

Visa or Mastercard accepted. C.O.D orders \$3 extra

Send check or M.O. to: Colorware, 242-W West Ave, Darien CT 06820

Add \$3 per order for shipping (\$5 to Canada, 10% to overseas).

CT residents add 7.5% sales tax



There are ships out there — waiting for you

Sea War

By Jeff Hameluck

Sea War is a one-player game where you try to sink the ships the CoCo has hidden on a 10-by-10 grid. It requires at least 16K Extended Color Basic and the standard CoCo joystick or mouse. It does not use high resolution graphics, but it does use multi-dimensional arrays, thereby requiring Extended Color Basic. Sea War will also run on the CoCo 3 if it is run on the 32-column text screen.

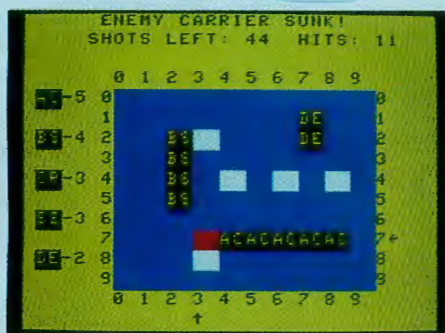

When you run Sea War, a title screen will appear and theme music will play. To start the game simply press the right joystick button, and the game will continue. There is no need to wait for the music to cease. The next screen simply gives a little background information about the game's scenario. To continue, press the right joystick button once again. Next, the information on the ships you must sink is displayed (See Figure 1).

Jeff Hameluck is a high school senior who has won a BASIC programming contest sponsored by the Regina Student Chapter of the Association for Computing Machinery.

After you press the button again, the game begins. The computer will put the five ships somewhere on the 10-by-10 grid. It is your job to sink all of the ships in 60 shots or less. The ships will be placed on the grid either vertically or horizontally, but not diagonally. The length of each ship is the same as the number of hits it requires to sink the ship. Therefore, since it takes five hits to sink an Aircraft Carrier, an Aircraft Carrier will be five units long, and so on. Also, each hit has to be in a different part of the ship. In other words, once one part of the ship is hit, a second shell there will just waste ammunition; the shell counts as a shot, not a hit.



Aircraft Carrier:	5 hits to sink
Battle Ship:	4 hits to sink
Crusier:	3 hits to sink
Submarine:	3 hits to sink
Destroyer:	2 hits to sink

Figure 1

To shoot, use the right joystick to move the cursor on the screen over the top of the square you want to shoot. There are pointers along the vertical and horizontal axes to help guide you. Once you are positioned, press the button. If the square comes up white, there is no ship there. If it comes up showing anything but white, you have hit a ship. The ship will be represented by a two-letter acronym on the game board. The type and location of the ship will be displayed at the top of the screen. The acronyms are listed on the left side of the screen with the number of hits



The Amazing A-BUS

NEW

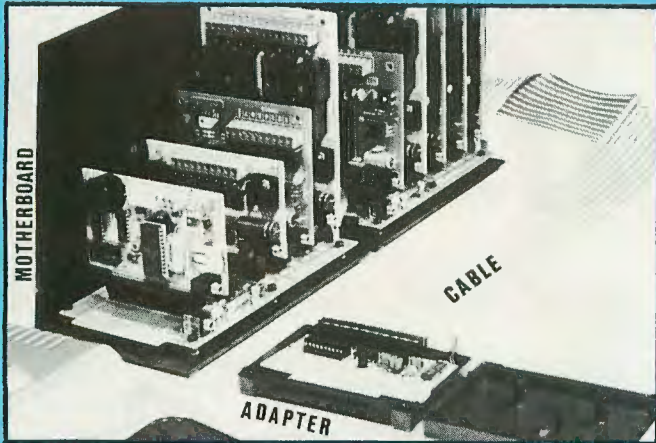

An A-BUS system with two Motherboards
A-BUS adapter in foreground

The A-BUS system works with the original CoCo,
the CoCo 2 and the CoCo 3.

Plug into the future

With the A-BUS you can plug your PC (IBM, Apple, TRS-80) into a future of exciting new applications in the fields of control, monitoring, automation, sensing, robotics, etc.

Alpha's modular A-BUS offers a proven method to build your "custom" system today. Tomorrow, when you are ready to take another step, you will be able to add more functions. This is ideal for first time experimenting and teaching.

A-BUS control can be entirely done in simple BASIC or Pascal, and no knowledge of electronics is required!

An A-BUS system consists of the A-BUS adapter plugged into your computer and a cable to connect the Adapter to 1 or 2 A-BUS cards. The same cable will also fit an A-BUS Motherboard for expansion up to 25 cards in any combination.

The A-BUS is backed by Alpha's continuing support (our 11th year, 50000 customers in over 60 countries).

The complete set of A-BUS User's Manuals is available for \$10.

About the A-BUS system:

- All the A-BUS cards are very easy to use with any language that can read or write to a Port or Memory. In BASIC, use INP and OUT for PEEK and POKE with Apples and Tandy Color Computers
- They are all compatible with each other. You can mix and match up to 25 cards to fit your application. Card addresses are easily set with jumpers.
- A-BUS cards are shipped with power supplies (except PD-123) and detailed manuals (including schematics and programming examples).

Relay Card

RE-140: \$129

Includes eight industrial relays. (3 amp contacts, SPST) individually controlled and latched. 8 LED's show status. Easy to use (OUT or POKE in BASIC). Card address is jumper selectable.

Reed Relay Card

RE-156: \$99

Same features as above, but uses 8 Reed Relays to switch low level signals (20mA max). Use as a channel selector, solid state relay driver, etc.

Analog Input Card

AD-142: \$129

Eight analog inputs. 0 to +5V range can be expanded to 100V by adding a resistor. 8 bit resolution (20mV). Conversion time 120us. Perfect to measure voltage, temperature, light levels, pressure, etc. Very easy to use.

12 Bit A/D Converter

AN-146: \$139

This analog to digital converter is accurate to .025%. Input range is -4V to +4V. Resolution: 1 millivolt. The on board amplifier boosts signals up to 50 times to read microvolts. Conversion time is 130ms. Ideal for thermocouple, strain gauge, etc. 1 channel. (Expand to 8 channels using the RE-156 card).

Digital Input Card

IN-141: \$59

The eight inputs are optically isolated, so it's safe and easy to connect any "on/off" devices, such as switches, thermostats, alarm loops, etc. to your computer. To read the eight inputs, simply use BASIC INP (or PEEK).

24 Line TTL I/O

DG-148: \$65

Connect 24 input or output signals (switches or any TTL device) to your computer. The card can be set for: input, latched output, strobed output, strobed input, and/or bidirectional strobed I/O. Uses the 8255A chip.

Clock with Alarm

CL-144: \$89

Powerful clock/calendar with: battery backup for Time, Date and Alarm setting (time and date); built in alarm relay, led and buzzer; timing to 1/100 second. Easy to use decimal format. Lithium battery included.

Touch Tone® Decoder

PH-145: \$79

Each tone is converted into a number which is stored on the board. Simply read the number with INP or POKE. Use for remote control projects, etc.

A-BUS Prototyping Card

PR-152: \$15

3 1/2 by 4 1/2 in. with power and ground bus. Fits up to 10 I.C.s

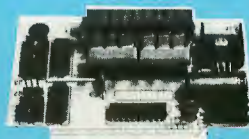

ST-143



CL-144



RE-140



IN-141



AD-142

Smart Stepper Controller SC-149: \$299

World's finest stepper controller. On board microprocessor controls 4 motors simultaneously. Incredibly, it accepts plain English commands like "Move arm 10.2 inches left". Many complex sequences can be defined as "macros" and stored in the on board memory. For each axis, you can control: coordinate (relative or absolute), ramping, speed, step type (half, full, wave), scale factor, units, holding power, etc. Many inputs: 8 limit & "wait until" switches, panic button, etc. On the fly reporting of position, speed, etc. On board drivers (350mA) for small steppers (MO-103). Send for SC-149 flyer.

Remote Control Keypad Option RC-121: \$49

To control the 4 motors directly, and "teach" sequences of motions.

Power Driver Board Option PD-123: \$89

Boost controller drive to 5 amps per phase. For two motors (eight drivers).

Breakout Board Option BB-122: \$19

For easy connection of 2 motors. 3 ft. cable ends with screw terminal board.

Stepper Motor Driver ST-143: \$79

Stepper motors are the ultimate in motion control. The special package (below) includes everything you need to get familiar with them. Each card drives two stepper motors (12V, bidirectional, 4 phase, 350mA per phase).

Special Package: 2 motors (MO-103) + ST-143: PA-181: \$99

Stepper Motors MO-103: \$15 or 4 for \$39

Pancake type, 2 1/4" dia. 1/4" shaft, 7.5°/step, 4 phase bidirectional, 300 step/sec, 12V, 36 ohm, bipolar, 5 oz-in torque, same as Airpax K82701-P2.

Current Developments

Intelligent Voice Synthesizer, 14 Bit Analog to Digital converter, 4 Channel Digital to Analog converter, Counter Timer, Voice Recognition.

A-BUS Adapters for:

IBM PC, XT, AT and compatibles. Uses one short slot.	AR-133...\$69
Tandy 1000, 1000 EX & SX, 1200, 3000. Uses one short slot.	AR-133...\$69
Apple II, II+, IIe. Uses any slot.	AR-134...\$49
TRS-80 Model 102, 200 Plugs into 40 pin "system bus"	AR-136...\$69
Model 100. Uses 40 pin socket. (Socket is duplicated on adapter).	AR-135...\$69
TRS-80 Mod 3.4.4.D. Fits 50 pin bus. (With hard disk use Y-cable)	AR-132...\$49
TRS-80 Model 4P. Includes extra cable (50 pin bus is recessed).	AR-137...\$62
TRS-80 Model I. Plugs into 40 pin I/O bus on KB or E/I.	AR-131...\$39
Color Computers (Tandy). Fits ROM slot. Multipak, or Y-cable.	AR-138...\$49

A-BUS Cable (3 ft. 50 cond.)

Connects the A-BUS adapter to one A-BUS card or to first Motherboard.

Special cable for two A-BUS cards: CA-162: \$34

A-BUS Motherboard

MB-120: \$99

Each Motherboard holds five A-BUS cards. A sixth connector allows a second Motherboard to be added to the first (with connecting cable CA-161: \$12). Up to five Motherboards can be joined this way to a single A-BUS adapter. Sturdy aluminum frame and card guides included.

• The A-BUS is not a replacement for the Multi-pak

Add \$3.00 per order for shipping.
Visa, MC, checks, M.O. welcome.
CT & NY residents add sales tax.
C.O.D. add \$3.00 extra.
Canada: shipping is \$5
Overseas add 10%



ALPHA Products

242-W West Avenue, Darien, CT 06820

Technical info: (203) 656-1806
Orders only 800 221-0916
Except in CT
Connecticut orders: (203) 348-9436
All lines open weekdays 9 to 5 Eastern time

SPECIAL

WITH YOUR
COCO MAX III ORDER:

- FREE DEMO DISK
- FREE COCOSHOW PROGRAM
- FREE EXTRA FONTS DISK



CoCo Max™ III



must be the most enjoyable, useful,
and awesome program you've ever
seen or your money back. Instantly,
no questions asked.

CALL NOW TOLL FREE 1-800 221 Mon-Fri
9 to 5 EST AND LET THE FUN BEGIN

A FEW QUOTES :

An outstanding program that almost turns your CoCo into a replica of the Macintosh. Terrific hi-res color, very easy to learn and use.
- *Family Computing*

There is absolutely nothing else on the Color Computer that is comparable to CoCo Max's power and ease of use. The most enjoyable time with a computer I ever had.
- *Computerware Review*

In Everyone's book, CoCo Max is rated again and again as the most incredible product ever marketed for the CoCo.
- *CoCo America Club*

I never expected to see anything like it on my CoCo screen. There isn't a single command to remember. Even a person who has no drawing ability like myself can create a presentable picture. I've spent hours just doodling enjoying all the things from silly to the serious. Fascinating experience. Buy it, you won't be sorry.
- *6809 Express*

Note: There is only one CoCo Max III. Do not confuse **COLORWARE**'s CoCo Max with similar sounding imitations.

INTRODUCING THE NEXT GENERATION:

CoCo Max™ III*

More Resolution

More Power

More Color

Built-in Animation

More Speed

More Type Styles

More Tools

Amazing Color Sequencing

"The best program ever written for the Color Computer"

That's how thousands of enthusiastic users rated the CoCo Max II drawing program. With CoCo Max III we are ready to amaze them again. Instead of "patching" CoCo Max II, we rewrote it from scratch to take advantage of the CoCo Max III hardware. The results will knock your socks off! Below is a brief list of some of the *new* features, but some, such as **animation**, **color sequencing**, or the **slide show**, have to be seen. Send for the Demo Disk, and see for yourself.

Everybody's favorite drawing package features:

- A 50% larger editing window.
- Zoom area 400% larger.
- New drawing tools: rays, 3D cubes, arcs,...
- New editing tools: shadow, text size,...
- Rotate by 1.5° steps
- Select any 16 of the 64 possible colors (all 64 colors displayed at once!)
- Powerful color mix: additive, subtractive, overlay,...
- Full color editing of patterns and color changing patterns.
- Incredible special effects with color cycling up to 8 colors with variable speed.
- Animation adds the dimension of motion to your image. (Must be seen.)
- Sophisticated data compression saves up to 70% of disk space when saving pictures.

In addition, there are dozens of enhancements to the multitude of features that made CoCo Max II a best seller.

More about CoCo Max III

- CoCo Max III is not an upgrade of CoCo Max II. It is entirely rewritten to take advantage of the new CoCo 3 hardware (More memory, resolution, colors, speed,...)
- The new CoCo Max III Hi-Res Interface and the CoCo Max II Hi-Res Pack are *not* interchangeable.
- The new interface plugs into the joystick connector.
- The CoCo Max III disk is not copy protected.
- CoCo Max III only works with the CoCo 3.
- A Y-Cable or Multi-pak is not necessary.
- Colors are printed in five shades of gray.
- CoCo Max III can read CoCo Max II pictures.

Note: CoCo Max II (for the CoCo 2) is still available on disk (\$79.95). CoCo Max I is still available on tape (\$69.95). For details, refer to our double page ad in any *Rainbow* from January '86 to July '87

Toll Free operators are for orders only. If you need precise answers, call the **tech line**. (Detailed CoCo Max specs are included with the Demo Disk.)

Add \$3.00 per order for shipping.
 Visa, MC, checks, M.O. welcome.
 CT residents add sales tax.
 C.O.D. add \$3.00 extra.
 Canada: shipping is \$5
 Overseas add 10%

Technical info: (203) 656-1806
 Orders only
 Except in CT 800 221-0916
 Connecticut orders (203) 348-9436
 All lines open weekdays 9 to 5 Eastern time

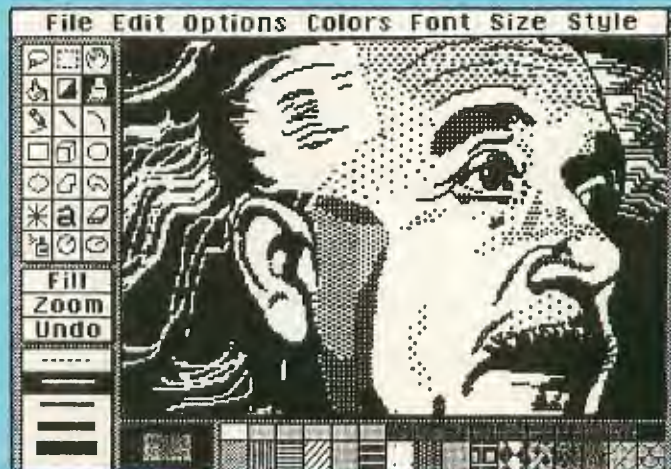

Imagine this picture in sixteen colors!

Guaranteed Satisfaction
 Use CoCo Max for a full month.
 If you are not delighted with it,
 we will refund every penny.

System Requirements:

Any CoCo 3 disk system with a Joystick or a Mouse.

We apologize to tape users, CoCo Max III needs the flexibility of a disk.

The CoCo Max III system includes: • The special Hi-Res interface (for your mouse or joystick) • The CoCo Max III disk • Many utilities: (To convert Max II pictures, Max colors, etc.) • A detailed User's Manual. Complete system: nothing else to buy. **CoCo Max III: \$79.95***

WITH COUPON ONLY

FREE DEMO DISK

Name _____

Street _____

City _____

State Zip _____

Printer used: _____

Please include \$2 to help defray Processing and Shipping costs. (Check, Money Order, etc. Sorry, no COD or Credit Cards). Coupon (or copy) must be mailed to:

COLORWARE

COLORWARE
 242-W West Avenue
 Darien, CT 06820

A division of Sigma Industries, Inc.

* Beware of inferior imitations that **DO NOT** include a Hi-Res Interface or charge extra for each utility

required to sink that vessel.

The game will end after you have either hit and sunk all five ships or used up all 60 rounds of ammunition. Either way, the screen will display the true locations of all the ships. You will then

be given a rating of one to 10 based on your shots-to-hits ratio. To play again, press Y or the right joystick button. To quit, press N. If neither of these keys are pressed, the game will start over at the theme song.

(Questions or comments regarding this program may be directed to the author at 67 Dutton Crescent, Regina, Saskatchewan, Canada S4N 4E4. Please enclose an SASE when requesting a reply.)

✓ 41044	1510115
63087	174098
740180	1900239
96053	205018
1270224	END130

The listing: SEAWAR

```
100 '
110 ' +-----+
120 ' :   S E A   W A R   :
130 ' +-----+
140 ' :                               :
150 ' : COPYRIGHT (C)  1988 :
160 ' :                               :
170 ' +-----+
180 ' :                               :
190 ' : by: Jeff Hameluck :
200 ' :                               :
210 ' +-----+
220 '
230 CLS
240 PRINT @ 33,STRING$(30,191);
250 FOR X=65 TO 417 STEP 32
260 PRINT @ X,CHR$(191);
270 PRINT @ X+29,CHR$(191);
280 NEXT X
290 PRINT @ 449,STRING$(30,191);
300 A$="jeff"
310 GOSUB 490
320 PRINT @ 100,B$;
330 A$="hameluck"
340 GOSUB 490
350 PRINT @ 109,B$;
360 A$="proudly"
370 GOSUB 490
380 PRINT @ 169,B$;
390 A$="presents"
400 GOSUB 490
410 PRINT @ 232,B$;
420 A$="sea"+CHR$(128)+"war"
430 GOSUB 490
440 PRINT @ 297,B$;
450 B$=CHR$(128)
460 PRINT @ 356,"press";B$;"the"
;B$;"right";B$;"joystick";
470 PRINT @ 393,"button";B$;"to"
;B$;"play";
480 GOTO 550
490 B$=""
500 FOR X=1 TO LEN(A$)
510 B$=B$+MID$(A$,X,1)+CHR$(128)
520 NEXT X
530 B$=LEFT$(B$,LEN(B$)-1)
```

```
540 RETURN
550 FOR X=1 TO 55
560 READ A$
570 PP=PEEK(65280)
580 IF PP=254 OR PP=126 THEN 660
590 PLAY A$
600 NEXT X
610 RESTORE
620 GOTO 550
630 DATA "T5L8O4C","O3B","O4L4C"
,"O3C","C","L8G","F","E","G","O4
C","O3B","O4C","L8O4E","D","C","
O4"
640 DATA "L4D","O3D","D","L8D","
C","O2B","O3G","G","F+","L4G","L
8O3A","B","O4C","O3B","A","G","A
"
650 DATA "G","F","E","F","E","D"
,"C","D","C","O2B","A","L8O2G","
O3C","O2B","O3D","C","E","D","F"
,"L4E","C","C"
660 CLS
670 PRINT
680 PRINT" YOU COMMAND A SHORE
BATTERY WHICH HAS BEEN ORDERED
TO SINK AN ENEMY FLEET ANCHORE
D IN A FOGGY COVE IN FRONT OF
YOU. YOU CAN'T SEE THE SHIPS RI
GHT AWAY BUT AS SOON AS YOU HIT
ONE THE LOCATION AND TYPE OF S
HIP WILL BE KNOWN";
690 PRINT" BECAUSE THE EXPLOSION
WILL HIGHLY ILLUMINATE THE
THE IMMEDIATE AREA FOR A SHORT
TIME. YOU ONLY HAVE 60 ROUNDS
TO SINK THE 5 SHIP ENEMY FLEET
WHICH CONSISTS OF:"
700 PRINT @ 482,"PRESS THE BUTTO
N TO CONTINUE";
710 FOR X=1 TO 200
720 NEXT X
730 PP=PEEK(65280)
740 IF PP=254 OR PP=126 THEN 750
ELSE 730
750 CLS:PRINT"AIRCRAFT CARRIER-5
HITS TO SINK BATTLE SHIP -4
HITS TO SINK CRUISER -3
HITS TO SINK SUBMARINE -3
HITS TO SINK DESTROYER -2
HITS TO SINK"
760 PRINT @ 482,"PRESS THE BUTTO
N TO CONTINUE";
770 FOR X=1 TO 200
780 NEXT X
790 PP=PEEK(65280)
```

VIP Writer III

VIP Writer has ALWAYS led the pack with features and now VIP Writer III still leads the way! The chart below illustrates this fact. Telewriter 128 only gives you 48K for text. Why is it called Telewriter 128? Word power 3 gives only 72K! VIP Writer III makes use of over 106K! VIP Writer III is the ONLY CoCo 3 word processor worthy of it's name!

WORD PROCESSOR COMPARISON CHART			
CoCo3 with 128K	VIP Writer III	Telewriter 128	Word Power 3
Text Storage	OVER 49,000	48,000	72,000
Print Spooler	YES 57,000	NONE	NONE
Total Storage	1 0 6, 0 0 0	48,000	72,000
Spelling Checker	VIP Speller	NONE	FREE WARE
RGB HD Support	100%	NONE	NONE
Screen Display	32/40/64/80	40/80	80

SCREEN DISPLAY OPTIONS

As the chart above shows - VIP Writer III offers more screen width options -all with 24 lines and actual lower case letters. It uses the CoCo 3's hardware display and double clock speed and is VERY VERY FAST! You can choose fore and background colors from up to 64 different hues. Color can be turned ON or OFF for the best possible display using a color or monochrome monitor or TV set. VIP Writer III has a built in on-line context sensitive help facility which displays command usage in easy to read colored windows.

CUSTOMIZER & PRINTER INSTALLER

VIP Writer III comes with a configuration / printer installation program which lets you customize VIP Writer III to suit your own liking. You can set screen width and colors as well as margins and more. You can also install your own printer and set interface type (serial, parallel or J&M), baud rate, line feeds, etc. Once done, you never have to enter these parameters again! VIP Writer III will load n' go with your custom configuration every time!

TEXT FILE STORAGE

VIP Writer III creates ASCII text files which are compatible with all other VIP Programs as well as other programs which use ASCII file format. You can use VIP Writer III to even create BASIC programs! There is a 49K text buffer and disk or cassette file linking allowing virtually unlimited text space. VIP Writer III works with up to four disk drives and lets you display disk directories and free space as well as rename or kill disk files. In addition VIP Writer III is 100% compatible with the RGB Computer Systems HARD DISK.

EDITING FEATURES

VIP Writer III has a full featured screen editor which can be used to edit text with lines up to 240 characters long with or without automatic word wrap around. You can select type-over mode or insert mode. There is even an OOPS command to recall a cleared text buffer. Other editing features include: Type-ahead • typamatic key repeat and key beep for flawless text entry • end of line bell • full four way cursor control with scrolling • top of textfile • bottom of textfile • page up • page down • top of screen • bottom of screen • beginning of line • end of line • left one word • right one word • DELETE character, to beginning or end of line, word to the left or right, or entire line • INSERT character or line • LOCATE and/or CHANGE or DELETE single or multiple occurrence using wildcards • BLOCK copy, move or delete with up to TEN simultaneous block manipulations • TAB key and programmable tab stops • word count • line restore • three PROGRAMMABLE FUNCTIONS to perform tasks such as auto column creation and multiple copy printing.

TEXT FORMATTING

VIP Writer III automatically formats your text for you or allows you to format your text in any way you wish. You can change the top, bottom, left or right margin and page length. You can set your text flush left, center or flush right. You can turn right hand justification on or off. You can have headers, footers, page numbers and TWO auxiliary lines which can appear on odd, even or all pages. You can also select the line on which they appear! You can even change the line spacing! Parameters can be altered ANYWHERE!

PREVIEW PRINT WINDOW

VIP Writer III features an exclusive format window which allows you to preview your document BEFORE PRINTING IT! You are able to move up, down, left and right to see centered text, margins, page breaks, orphan lines etc. This makes hyphenation a snap!

PRINTING

VIP Writer III prints TWICE as fast as any other CoCo word processor! It supports most serial or parallel printers using J&M JFD-CP or Rainbow interface and gives you the ability to select baud rates from 110 to 19,200. You can embed printer control codes anywhere in your text file EVEN WITHIN JUSTIFIED TEXT! VIP Writer III also has TWENTY programmable printer macros which allow you to easily control all of your printers capabilities such as bold, underline, italics and superscript using simple key strokes. Other features include: multiple copy printing • single sheet pause • line feeds.

PRINT SPOOLING

Save up to \$150 on a print spooler because VIP Writer III has a built in print spooler with a 57,000 character buffer which allows you to print one document WHILE you are editing another. You don't have to wait until your printer is done before starting another job!

DOCUMENTATION

VIP Writer III is supplied with a 125 page instruction manual which is well written and includes many examples. The manual has a tutorial and glossary of terms for the beginner as well as a complete index! VIP Writer III includes VIP Speller. DISK \$79.95
Cassette version does not include VIP Speller. TAPE \$59.95

VIP Writer owners: Upgrade to the VIP Writer III Disk for \$49.95 or Tape for \$39.95. Send original disk or tape. Include \$3 S/H.

It's Word Processor Trade In Time

For a limited time you can trade in your old software for the VIP Writer I or III and save up to \$20! Send in your old disk or tape and manual. VIP Writer tape \$34.95, disk \$49.95. VIP Writer III tape \$44.95, disk \$59.95. Include \$3.00 shipping. Offer expires 8/31/88

VIP Database III

The VIP Database III features selectable screen displays of 40, 64 or 80 characters by 24 lines with choice of 64 foreground and background colors for maximum utility. It uses the CoCo 3's hardware screen and double clock speed to be the FASTEST database available! VIP Database III will handle as many records as will fit on your disks and is structured in a simple and easy to understand menu system with full prompting for easy operation. Your data is stored in records of your own design. All files are fully indexed for speed and efficiency. Full sort of records is provided for easy listing of names, figures, addresses, etc., in ascending or descending alphabetical or numeric order. Records can be searched for specific entries using multiple search criteria. With Database III mail-merge you may also combine files, sort and print mailing lists, print form letters, address envelopes - the list is endless. The built-in MATH package even performs arithmetic operations and updates other fields. VIP Database III also has a print spooler and report generator with unlimited print format capabilities including embeddable control codes for use with ALL printers. DISK \$69.95

VIP Database owners: Upgrade to the VIP Database III Disk for \$39.95. Send original disk. Include \$3 shipping.

VIP Integrated Library

The VIP Integrated Library combines all six popular VIP application programs - VIP Writer, Speller, Calc, Database, Terminal and Disk-ZAP - into one program on one disk! The program is called VIP Desktop. From the desktop you have instant access to word processing with a spelling checker always in attendance, data management with mail merge, spreadsheet financial analysis, telecommunications and disk maintenance. 64K, required. Include \$4.00 shipping for this product. DISK \$149.95
*CoCo 3 owners: Purchase the VIP Integrated Library /WDE (Writer & Database Enhanced) which has the VIP Writer III and VIP Database III in place of the VIP Writer and VIP Database. Include \$4.00 shipping for this product. DISK \$169.95

Previous VIP Library owners: Call or write for upgrade pricing.

VIP Writer

VIP Writer is also available for CoCo 1 and 2 owners and has all the features found in the VIP Writer III including VIP Speller except for the following: The screen display is 32, 51, 64 or 85 columns by 21 or 24 rows. Screen colors are green, black or white. Help is not presented in colored windows. Double clock speed is not supported. Parallel printer interface is not supported. Print spooler is not available. Hard disk is not supported. Even so, VIP Writer still out-features the rest! It's a CoCo 1 or 2 owners best choice in word processors. Includes VIP Speller. DISK \$69.95
Cassette version does not include VIP Speller. TAPE \$49.95

VIP Speller

VIP Speller works with ANY ASCII file created by most popular word processors. It automatically checks text files for words to be corrected, marked for special attention or even added to the dictionary. You can even view the misspelled word in context! VIP Speller comes with a specially edited 50,000 word dictionary, and words can be added to or deleted from the dictionary or you can create your own. DISK \$34.95

VIP Database

VIP Database has all the features of VIP Database III except the screen widths are 51, 64 and 85. Screen colors are green, black and white, double speed is not supported, spooler is not available. Still VIP Database is the best database for the CoCo 1 & 2! DISK \$49.95

VIP Calc

Now every CoCo owner has access to a calculating and planning tool better than VisiCalc™, containing all its features and commands and then some. VIP Calc displays 32, 51, 64 or 85 characters by 21 or 24 lines right on the screen. VIP Calc allows up to a 33K worksheet with up to 512 columns by 1024 rows! In addition, VIP Calc has multiple windows which allow you to compare and contrast results of changes. Other features include 16 DIGIT PRECISION • trig. functions • averaging • algebraic functions • column and row ascending and descending SORTS • locate formulas or titles in cells • block move and replicate • global or local column width • limitless programmable functions • works with ANY printer. Embed printer control codes for customized printing. Combine spreadsheet data with VIP Writer documents to create ledgers, projections, statistical and financial budgets and reports. Requires 64K. DISK \$59.95

VIP Terminal

For your important communications needs you've got to go beyond software that only lets you chat. You need a smart terminal so that you can send and receive programs and messages and print them! The VIP Terminal features 32, 51, 64 or 85 characters by 21 or 24 lines on the screen and has a 43K byte buffer to store information. DISK \$39.95

VIP Disk-ZAP

VIP Disk-ZAP is the ultimate disk repair utility for simple and quick repair of most disk errors. Designed with the non-programmer in mind, the VIP Disk-ZAP will let you retrieve all types of bashed files, BASIC and Machine Language programs. It even works with 40 track drives! The 50 page tutorial makes the novice an expert. DISK \$24.95

All disk products are unprotected and run under RSDOS.

SD ENTERPRISES

☎(503) 663-2865 ☒POB 1233 Gresham, OR 97030

Please add \$3 for shipping and handling. Outside continental US add \$4 S/H. COD orders add an additional \$2.25. Checks allow 3 weeks for delivery. All other orders are shipped the same day.

Telewriter 128 is a trademark of Cognitac. Word Power 3 is a trademark of Microcom Software.

```

800 IF PP=254 OR PP=126 THEN 810
ELSE 790
810 CLS
820 DIM L(9,9)
830 DIM G$(12)
840 S(1)=5
850 S(2)=4
860 S(3)=3
870 S(4)=3
880 S(5)=2
890 G$(0)=CHR$(175)+CHR$(175)
900 FOR X=1 TO 5
910 G$(X)=G$(0)
920 NEXT X
930 G$(6)="ac"
940 G$(7)="bs"
950 G$(8)="cr"
960 G$(9)="sb"
970 G$(10)="de"
980 G$(11)=CHR$(207)+CHR$(207)
990 G$(12)=CHR$(191)+CHR$(191)
1000 A$=STRING$(20,175)
1010 PRINT @ 103,"0 1 2 3 4 5 6
7 8 9"
1020 FOR X=0 TO 9
1030 PRINT @ 134+X*32,RIGHT$(STR
$(X),1);A$;RIGHT$(STR$(X),1);
1040 NEXT X
1050 PRINT @ 455,"0 1 2 3 4 5 6
7 8 9"
1060 PRINT @ 129,"ac-5";
1070 PRINT @ 193,"bs-4";
1080 PRINT @ 257,"cr-3";
1090 PRINT @ 321,"sb-3";
1100 PRINT @ 385,"de-2";
1110 A=RND(-TIMER)
1120 FOR I=1 TO 5
1130 A=RND(49)
1140 FOR X=1 TO A
1150 B=RND(2)
1160 NEXT X
1170 IF B=1 THEN 1310
1180 V=RND(10)-1
1190 IF V>5 THEN V=V-5
1200 H=RND(10)-1
1210 FOR X=V TO V+S(I)-1
1220 IF L(H,X)<>0 THEN 1130
1230 NEXT X
1240 FOR X=V TO V+S(I)-1
1250 L(H,X)=I
1260 NEXT X
1270 GOTO 1400
1280 L(X,H)=I
1290 NEXT X
1300 GOTO 1400
1310 H=RND(10)-1
1320 IF H>5 THEN H=H-5
1330 V=RND(10)-1
1340 FOR X=H TO H+S(I)-1
1350 IF L(X,V)<>0 THEN 1130
1360 NEXT X
1370 FOR X=H TO H+S(I)-1
1380 L(X,V)=I
1390 NEXT X
1400 NEXT I
1410 OX=10
1420 OY=10
1430 PRINT @ 37,"SHOTS LEFT:";60
-SH;" HITS:";HT
1440 IF HT=17 THEN 2000
1450 IF SH=60 THEN 2000
1460 X=INT(JOYSTK(0)/7)
1470 Y=INT(JOYSTK(1)/7)
1480 PRINT @ 135+X*2+Y*32,G$(12)
;
1490 IF OX=X THEN 1520
1500 PRINT @ 487+(X*2),"^";
1510 PRINT @ 487+(OX*2)," ";
1520 IF OY=Y THEN 1550
1530 PRINT @ 156+(Y*32)," ";
1540 PRINT @ 156+(OY*32)," ";
1550 OY=Y
1560 OX=X
1570 PRINT @ 135+X*2+Y*32,G$(L(X
,Y));
1580 PP=PEEK(65280)
1590 IF PP=254 OR PP=126 THEN 16
10
1600 GOTO 1460
1610 PRINT @ 0
1620 SH=SH+1
1630 PLAY"O1L255V31"
1640 FOR M=1 TO 31
1650 PLAY"N10N3N5N4N2N6V-":NEXT
M
1660 Z=135+X*2+Y*32
1670 IF L(X,Y)=0 THEN 1970
1680 IF L(X,Y)=>6 THEN 1430
1690 HT=HT+1
1700 C=L(X,Y)
1710 ON C GOTO 1720,1770,1820,18
70,1920,
1720 PRINT @ Z,"ac";
1730 L(X,Y)=6
1740 HA=HA+1
1750 IF HA=5 THEN PRINT @ 6,"ENE
MY CARRIER SUNK!" ELSE PRINT @ 4
, "ENEMY CARRIER HIT AT ";RIGHT$
(STR$(X),1);", ";RIGHT$(STR$(Y),1
)
1760 GOTO 1430
1770 PRINT @ Z,"bs";
1780 L(X,Y)=7
1790 HB=HB+1
1800 IF HB=4 THEN PRINT @ 5,"ENE
MY BATTLESHIP SUNK!" ELSE PRINT
@ 2,"ENEMY BATTLESHIP HIT AT ";R
IGHT$(STR$(X),1);", ";RIGHT$(STR$
(Y),1)
1810 GOTO 1430
1820 PRINT @ Z,"cr";
1830 L(X,Y)=8

```



```

1840 HC=HC+1
1850 IF HC=3 THEN PRINT @ 7,"ENE
MY CRUISER SUNK!" ELSE PRINT @ 4
,"ENEMY CRUISER HIT AT ";RIGHT$(
STR$(X),1);", ";RIGHT$(STR$(Y),1)
1860 GOTO 1430
1870 PRINT @ Z,"sb";
1880 L(X,Y)=9
1890 HD=HD+1
1900 IF HD=3 THEN PRINT @ 5,"ENE
MY SUBMARINE SUNK!" ELSE PRINT @
3,"ENEMY SUBMARINE HIT AT ";RIG
HT$(STR$(X),1);", ";RIGHT$(STR$(Y
),1)
1910 GOTO 1430
1920 PRINT @ Z,"de";
1930 L(X,Y)=10
1940 HE=HE+1
1950 IF HE=2 THEN PRINT @ 5,"ENE
MY DESTROYER SUNK!" ELSE PRINT @
3,"ENEMY DESTROYER HIT AT ";RIG
HT$(STR$(X),1);", ";RIGHT$(STR$(Y
),1)
1960 GOTO 1430
1970 PRINT @ Z,CHR$(207);CHR$(20
7);
1980 L(X,Y)=11
1990 GOTO 1430
2000 FOR Y=0 TO 9

```

```

2010 FOR X=0 TO 9
2020 IF L(X,Y)=0 THEN L(X,Y)=11
2030 IF L(X,Y)<6 THEN L(X,Y)=L(X
,Y)+5
2040 PRINT @ 135+X*2+Y*32,G$(L(X
,Y));
2050 NEXT X,Y
2060 FOR X=1 TO 3500
2070 NEXT X
2080 CLS
2090 PRINT "SHOTS:";SH;" HITS:";
HT
2100 PRINT
2110 PRINT "ON A SCALE OF 1 TO 1
0"
2120 PRINT USING "YOU RATE A: ##
";(61-SH)/4.5+.5
2130 PRINT @ 487,"PLAY AGAIN <Y/
N>";
2140 FOR X=1 TO 1000
2150 A$=INKEY$
2160 PP=PEEK(65280)
2170 IF PP=254 OR PP=126 THEN CL
EAR:GOTO 810
2180 IF A$="Y" THEN CLEAR:GOTO 8
10
2190 IF A$="N" THEN CLS:END
2200 NEXT X
2210 RUN

```

SUNDOG SYSTEMS



In Quest of the Star★Lord

A new animated graphic adventure for the Color Computer 3 from the author of the Hall of the King trilogy! Enjoy the mixture of science and fantasy as you quest for the Phoenix Crossbow, the only thing that can save you in the post-holocaust world. A full 4 disk sides of adventure! Outstanding 320x200 graphics will make this your favorite CoCo adventure! Req. 128K CoCo 3 and disk drive. Only \$34.95.

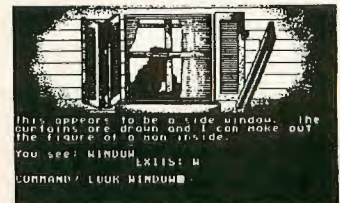

WHITE FIRE OF ETERNITY

64K Animated Graphic Adventure. See 12/86 Rainbow review. Only \$19.95.

Kung-Fu Dude

An exciting new arcade game. This is the long-awaited response to the huge demand for a Kung-Fu program for the CoCo. The graphics, sound effects, and animation are spectacular! This is the BEST karate game ever available for the Color Computer. Req. 64K, disk drive, and joystick. Only \$24.95.

"The CoCo karate gap has been filled and Kung-Fu Dude does it excellently. I highly recommend (it)!"
-2/88 Rainbow review
"A definite 5 stars!"
-12/87 Wizard's Castle review

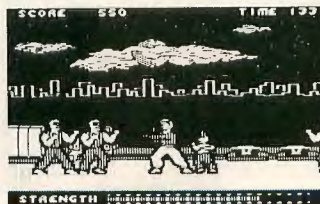

CHAMPION

64K Superhero Action Adventure. See 5/87 Rainbow review. Only \$19.95.

All programs CoCo 1, 2, 3 compatible unless stated otherwise.



Sundog Systems
21 Edinburg Drive
Pittsburgh, PA 15235
(412) 372-5674

Personal checks, money orders, and C.O.D. orders accepted.

Include \$2.50 for S/H. \$3.00 extra for C.O.D. orders. PA residents add 6% sales tax. Authorship and dealer inquiries welcome.



Test your skill with this strategic game of chess

It's Your Move

By Joel F. Klein

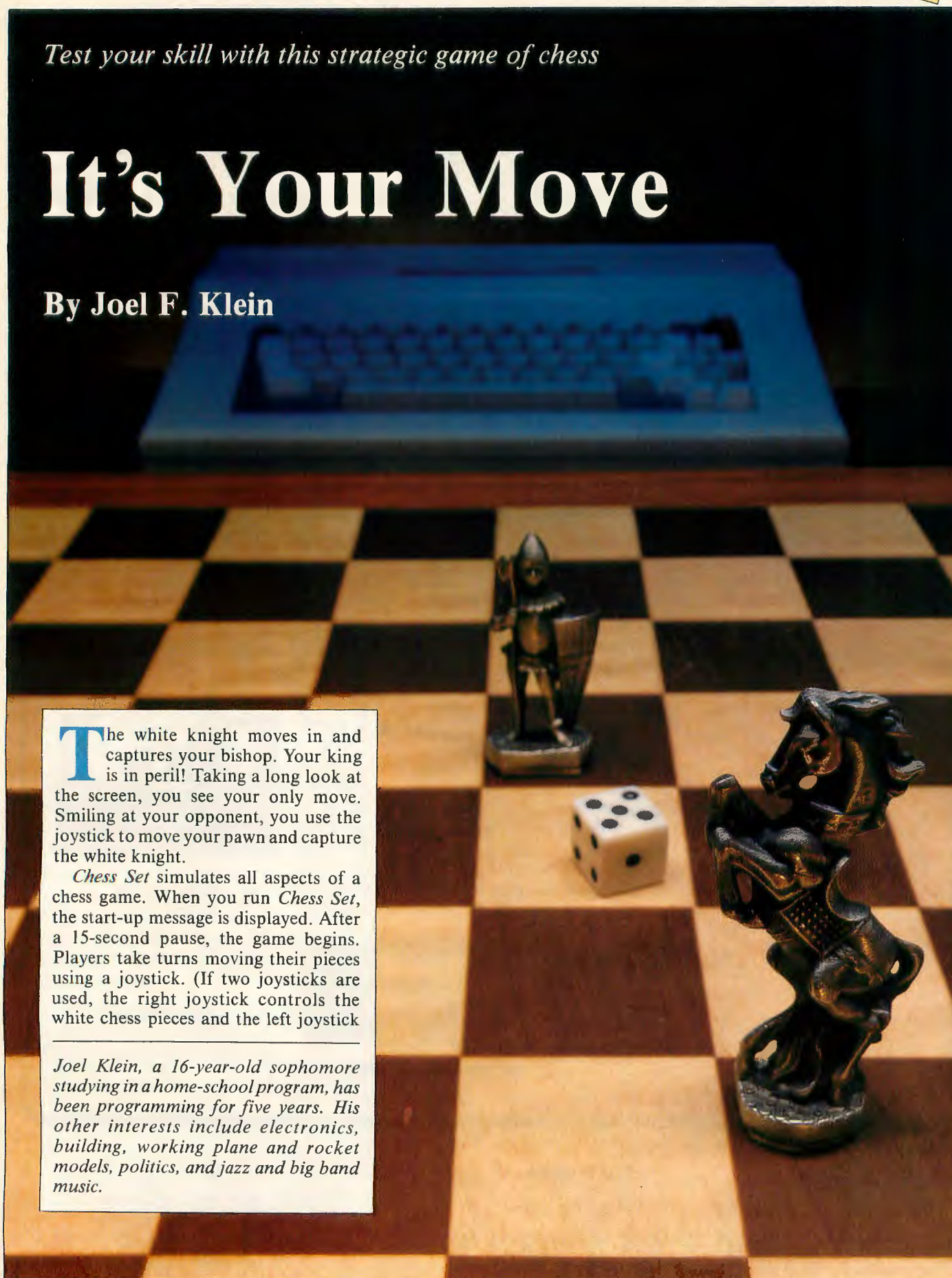

The white knight moves in and captures your bishop. Your king is in peril! Taking a long look at the screen, you see your only move. Smiling at your opponent, you use the joystick to move your pawn and capture the white knight.

Chess Set simulates all aspects of a chess game. When you run *Chess Set*, the start-up message is displayed. After a 15-second pause, the game begins. Players take turns moving their pieces using a joystick. (If two joysticks are used, the right joystick controls the white chess pieces and the left joystick

Joel Klein, a 16-year-old sophomore studying in a home-school program, has been programming for five years. His other interests include electronics, building, working plane and rocket models, politics, and jazz and big band music.

Telewriter-128™

the Color Computer 3 Word Processor

For over 5 years now, Telewriter has been the #1 Color Computer word processor, both in popularity and in performance. Telewriter's near perfect mix of sophisticated professional features and a very natural user interface, has earned it the highest praise in numerous magazines, and an intensely loyal following among tens of thousands of Color Computer users all over the world.

HISTORY

Throughout the history of the Color Computer, Telewriter has pioneered software breakthroughs that set the standards.

In 1981, it was Telewriter 1.0 that first took the Color Computer's inadequate 32X16 all-uppercase display, and replaced it with a graphics-based 51X24 upper and lowercase display.

A few years later, Telewriter-64 added high density 64X24 and 85X24 displays and access to the full 64K of the newer Color Computers.

THE NEW AGE

Today, Telewriter-64 is recognized as the standard Color Computer word processor. It runs on all Tandy Color Computers — from the original Color Computer 1, to the Color Computer 2, and 3.

But the Color Computer 3 brings a whole new level of power to low cost computing and, so, a new Telewriter is here to put that power to work for you. We call it Telewriter-128.

TELEWRITER-128

You don't mess with a good thing, so Telewriter-128 is still Telewriter-64 at heart. The commands, and the user interface are essentially the same. If you know Telewriter-64, then you already know Telewriter-128. And, if you don't know Telewriter-64, you'll still have an easy time learning and using Telewriter-128.

80 COLUMNS

But there are major differences as well. First, Telewriter-128 uses the Color Computer 3's new 80 column screen display.

This means, simply, that using Telewriter-128 on a low cost Color Computer 3 will look a lot like using a more expensive word processor on a much more expensive IBM PC, PS/2, or clone.

SPEED

Second, Telewriter-128 is lightning fast. Telewriter-64 was fast in its own right, but, by accessing the Color Computer 3's video hardware directly, and by running the machine in double speed mode, Telewriter-128 is able to provide extremely fast scrolling and instant paging — functions whose speed is crucial to serious word processing.

In this department, Telewriter-128 doesn't simply keep up with IBM-based word processors — it generally surpasses them!

EASE

Third, Telewriter-128 adds a host of new features big and small, that make it even easier to use.

Features like: Quick function key access to the editor or the menus — an instant on-line help screen summarizing all Telewriter commands and special characters — an option file where you store your personal set of format and screen settings so you only have to set them once!

Then, there's a quick save feature which allows you to save all your current work without leaving the editor. There's a simple way to cursor through the disk directory and read in a file by just hitting ENTER. And there's more.

NEW POWER

Telewriter-64 always had the power to handle any kind of serious writing, from letters to textbooks. But, here too, Telewriter-128 adds major features.

Like Macros — which let you insert whole words or phrases (even sets of control codes or format commands) into your text, with a single keypress. And every time you power up Telewriter-128, the macro definitions are automatically loaded*, so they're always there.

Then there's a Print Preview feature that shows you, on-screen, the way your printed text will look — with margins, headers, centering, justification, page numbering, and page breaks. This guarantees letter perfect documents every time, and makes tasks like widow/orphan line elimination, a breeze.

TELEWRITER-64 OR TELEWRITER-128

We could go on listing features, but the point is this: If you own a Color Computer, you already have the hardware for the most powerful, low cost word processor in town. All you need now is to add the heart and soul:

Telewriter-64, for the Color Computer 1 and 2, costs \$59.95 on disk, \$49.95 on cassette.

Telewriter-128 for the Color Computer 3 costs \$79.95 on disk, \$69.95 on cassette.

To order by Mastercard or Visa call (619) 755-1258 anytime, or send check or money order plus \$2 shipping (Californians add 6% sales tax) to:

COGNITEC

704 Nob Ave.

Del Mar, CA 92014

To upgrade from Telewriter-64 to Telewriter-128, return your original disk or cassette with \$39.95. (Add \$10 if you're also upgrading from cassette to disk. Deduct \$10 with proof of Oct '87 - Feb '88, purchase of Telewriter-64.)

When I first got Telewriter-64 last year, I was in heaven. I couldn't believe the program's versatility and ease of use.

-The RAINBOW, Oct. 1985

TELEWRITER-64 FEATURES: Compatibility with any printer that works with the Color Computer; embedded control codes for underlining, boldface, sub/superscript, variable fonts; format commands for headers, centering, margin and spacing changes anywhere in the document; Format menu to set margins, spacing, page numbering, BAUD rate, lines per page, justification; Chain printing for one shot printing of multi-file documents. Fast, full-screen editor with wordwrap, block copy/move/delete, global search and replace, wild card search, fast 4-way auto-repeat cursor, fast scrolling, forward and backward paging, text alignment, tabs, error protection, word and line counter. Insert or delete text anywhere on the screen. Simple, easy to remember commands. Optional ASCII files for compatibility with spell checkers, terminal programs,

and BASIC. Load, save, append, partial save files to disk or cassette. Kill, rename and list disk files. Cassette verify and auto-retry on error.

TELEWRITER-128 - ADDITIONAL FEATURES: Print preview from editor; multiple copy print; footers; hanging indents; cursor thru disk directory to load, append, rename and kill files; quick file save from editor; keyclick; key repeat; true block move; 24, 25, or 28 line screen; 40 or 80 column screen; dual speed cursor; on-line help; overstrike mode; word delete; wordwrap at margin; user definable macros; nested macros; instant status window for information on cursor position, word count, etc.; instant function key access to menus or editor; options menu for setting character and screen colors, key repeat and delay rates, definable foreign symbols.



T & D SUBSCRIPTION SOFTWARE CELEBRATES 6 YEARS

ISSUE #1, JULY 1982

COVER 1
RACE TRACK
HANGMAN
MUSIC ALBUM
LIFE EXPECTANCY
WORD TESTS
KILLER MANSION
BARTENDER
CALENDAR
ROBOT WAR

ISSUE #2, AUG. 1982

UFO COVER PT. 1
BIORHYTHM
BOMBARDMENT
BLACK JACK
COST OF LIVING
FRENZY
BUSINESS LETTER
QUICK THINK
QUEST INSTRUCTIONS
QUEST FOR LENORE

ISSUE #3, SEPT. 1982

UFO COVER PT.2
BASKETBALL
CHUCKLUCK
SLOT MACHINE
ALPHABETIZER
NFL PREDICTIONS
FLAG CAPTURE
ROBOT BOMBER

ISSUE #4, OCT. 1982

UFO RESCUE
TANK BATTLE
DRIVEWAY
SOUNDS
BALLOON DROP
MIND BOGGLE
COCO-TERRESTRIAL ADV.
CALORIE COUNTER
JACK-O-LANTERN

ISSUE #5, NOV. 1982

CATALOG COVER
BOWLING
PROGRAM INVENTORY
PROMISSORY-LOANS
CHECKBOOK BALANCER
TRIGONOMETRY TUTOR
CONVOY
BAG-IT
SPECTRA SOUND
CONVEYOR BELT

ISSUE #6, DEC. 1982

CHRISTMAS COVER
RAINDROPS
STOCK MARKET
ADVANCE PONG
DESTROY
SOUND ANALYZER
CREATIVITY TEST
VOICE DATA
ML TUTORIAL PT.1
LOONY LANDER

ISSUE #7, JAN. 1983

NEW YEARS COVER
LIST ENHANCER
SUPER PRECISION DIV.
BOMB DIFFUSE
SPACE STATION
ML TUTORIAL PT. 2
SHOOT OUT
FIND UTILITY
CYBORG INS.
CYBORG FACES

ISSUE #8, FEB., 1983

COVER 8
DEFEND
3 DIMENSIONAL MAZE
COCO CONCENTRATION
AUTO LINE NUMBERING
ML TUTORIAL PT.3A
ML TUTORIAL PT.3B
NUCLEAR POWER PLANT
DUAL BARRIER
BRICKS

ISSUE #9, MARCH 1983

TIME MACHINE COVER
TRIG DEMO
PYRAMID OF CHEOPS
PROGRAM PACKER
BUDGET
ELECTRONIC DATE BOOK
ML TUTORIAL PT.4
TAPE DIRECTORY
BLOCK-STIR
COCO ADDING MACHINE

ISSUE #10, APRIL 1983

TENTH COVER
PYRAMID OF DANGER
TYPING TUTOR
ML TUTORIAL PT.5
TINYCALC
STOCK MARKET COMP
YAH-HOO
MISSILE ATTACK
SCREEN PRINT
BRIKPNG

ISSUE #11, MAY 1983

ELEVENTH COVER
ARCHERY
FROG JUMP
ML TUTORIAL PT.6
MLT DICTIONARY
BASIC SPEED UP TOT.
METRIC CONVERTOR
GRAPHIC QUAD ANTENNA
GRAPHICS PROGRAM
CATERPILLAR CAVE

ISSUE #12, JUNE 1983

TWELFTH COVER
SHOOTING GALLERY
BOMB STOPPER
VALLEY BOMBER
STAR FIGHTER
WHEEL OF FORTUNE
ML TUTORIAL PT.7
MERGE UTILITY
RAM TEST
LANDER

ISSUE #13, JULY 1983

THIRTEENTH COVER
FLASH CARD
ICE BLOCK
COSMIC FORTRESS
MAIL LIST
DOLLARS & CENTS
ML TUTORIAL PT.8
SDSK COPY
MUSIC SYNTHESIZER
CRAWLER

ISSUE #14, AUG. 1983

MYSTERY COVER
ROW BOAT
COMPUTER TUTL PT. 1
INDEX DATA BASE
DISK ZAPPER
COCO-MONITOR
COCO-ARTIST
ROBOT COMMAND
TEST SCREEN PRINT
HIGH RESOLUTION TEXT

ISSUE #15, SEPT. 1983

MYSTERY COVER PT.2
GOLD VALUES
TREK INSTRUCTIONS
TREK
HIGH TEXT MODIFICATION
ASTRO DODGE
DR. COCO
PEG JUMP
MORSE CODE
PURGE UTILITY

ISSUE #16, OCT. 1983

MYSTERY COVER
BOBOTRON
DIRECTORY RECALL
VECTOR GRAPHICS INST.
VECTOR GRAPHICS
SKYDIVER
SWERVE AND DODGE
NIMBO BATTLE
TAPE ANALYSIS UTILITY
LIFE GENERATIONS

ISSUE #17, NOV. 1983

THANKSGIVING COVER
3-D TIC-TAC-TOE
INDY 500
COLLEGE ADVENTURE
MEMORY GAME
DUNGEON MASTER
WEATHER FORECASTER
GRID FACTOR INST.
GRID FACTOR
DRAW

ISSUE #18, DEC. 1983

CHRISTMAS COVER
CLIMBER
GALACTIC CONQUEST
WARLORDS
STATES REVIEW
MATH TUTOR
MACHINE LANGUAGE DATA
PRINTER UTILITY INST.
PRINTER UTILITY
MUTANT WAFFLES

ISSUE #19, JAN. 1984

BANNER
PROBE
DISK DIR. PROTECTOR
OPTICAL CONFUSION
WORD PROCESSOR
WORD SEARCH
ASTRONAUT RESCUE
STAR TRAP
PIE CHART
FORCE FIELD

ISSUE #20, FEB. 1984

INTRDDUCTION
HINTS FOR YOUR COCO
ESCAPE ADVENTURE
SEEKERS
MASTER BRAIN
LIST CONTROLLER
DISKETTE CERTIFIER
ROM COPY
BASIC RAM
SNAFUS

ISSUE #21, MAR. 1984

BASIC CONVERSIONS
FINANCIAL ADVISE
CASTLE STORM
DOS HEAD CLEANER
COCO TERMINAL
SNAKE CRAWLER
WAR CASTLE
SKY FIRE
EASY BASIC
DOTS 3-D

ISSUE #22, APRIL 1984

HEALTH HINTS
GLIBLIBS
CLOTHER SLITHER
BIBLE 1 & 2
BIBLE 3 & 4
CATCH ALL
INVADER
ALIEN RAID
MOON ROVER
IO ERROR IGNORER

ISSUE #23, MAY 1984

MONEY SAVERS 1 & 2
STOCKS OR BOMBS
WALL AROUND
COCO TECHNICAL LOOK PT.1
NUCLEAR WAR INST.
THERMONUCLEAR WAR
CIRCUIT BREAKER
MOUSE SQUEEZE
SUPER SQUEEZE
DATA FALL

ISSUE #24, JUNE 1984

DIR PACK & SORT
BRICK OUT
COCO TECHNICAL LOOK PT. 2
USA SLIDE PUZZLE
51 *24 SCREEN EDITOR
51 *24 SCREEN EDITOR
CITY INVADERS
PRINTER SPOOLER
STEPS
SNAKE

ISSUE #25, JULY 1984

CLOCK
COCO TECHNICAL LOOK PT.3
SKID ROW ADVENTURE
MONEY MAKER
PIN-HEAD CLEANING
LINE EDITOR INST.
LINE EDITOR
BOOMERANG
BUBBLE BUSTER
ROCOCHET

ISSUE #26, AUG. 1984

PEEK POKE & EXECUTE
SAUCER RESCUE
YOUNG TYPER TUTOR
O-TEL-O
OLYMPIC EVENTS
DOUBLE DICE
COCO DATABASE
BATTLE STAR
COCO-PIN BALL
MONTEZUMAS DUNGEONS

ISSUE #27, SEPT. 1984

COCO TO COM 64
GALACTIC SMUGGLER
INDY RACE
ACCOUNT MANAGER
CASSETTE MERGE UTILITY
STRING PACKING TUTORIAL
SPACE DUEL
BUGS
TRAP-BALL
BALLOON FIRE

ISSUE #28, OCT. 1984

HANGING TREE
CHECKERS
FOOTBALL
MORE PEEKS & POKES
SPELLING CHECKER
SOUND DEVELOPMENT
WORD GAME
SCREEN REVERSE
AUTO COPY
RAT ATTACK

ISSUE #29, NOV. 1984

DISK ROLL OUT
ROBOT DN
MULTIPONG
ADVENTURE GENERATOR
QUEST ADVENTURE
QUARTER BOUNCE
DUAL OUTPUT
KEY REPEAT
FULL EDITOR
METEOR

ISSUE #30, DEC. 1984

MATH HELP
ZECTOR ADVENTURE
WORLD CONQUEST
DRAG RACE
MINE FIELD
T-NOTES TUTORIAL
T & D PROGRAM INDEXER
SYSTEM STATUS
ERROR TRAP
DROLL ATTACK

ISSUE #31, JAN. 1985

TREASURES OF BARSOOM
BATTLEGROUND
STRUCT. COMPILED LANG.
MINIATURE GOLF
STAR DUEL
ARITHMETIC FOOTBALL
GRID RUN
SPIRAL ATTACK
FAST SORT
MUNCHMAN

ISSUE #32, FEB. 1985

DR. SIGMUND
ICE WORLD ADVENTURE
LOTTERY ANALYST
BASIC COMPILER
MUSIC CREATOR
MEANIE PATROL
TRI-COLOR CARDS
SHAPE RECOGNITION
DISK BACKUP
SPACE PROTECTOR

ISSUE #33, MAR. 1985

LIGHT CYCLE
PAINT
SKEET SHOOTING
GUITAR NOTES
MI DISK ANALYZER
PERSONAL DIRECTORY
NAUGHA ADVENTURE
EGGS GAME
DISK DIRECTORY PRINT
SPEED KEY

ISSUE #34, APRIL 1985

HOVER TANK
POWER SWORD
TERMITE INVASION
SPELLING CHECKER
DOS BOSS
NINE CARD CHOICE
MUSIC GENERATOR
FYR-DRACA
DRIVE TEST
GRAPHIC TOUR

ISSUE #35, MAY 1985

SELECT A GAME 1
TAPE PROBLEMS
STROLL TRIVIA
SOFTBALL MANAGER
FONTS DEMO
CLOWN DUNK MATH
ALPHA MISSION
DOS ENHANCER
KNOCK OUT
HAUNTED HOUSE

ISSUE #36, JUNE 1985

SELECT A GAME 2
VIDEO COMPUTER
SPEECH SYNTHESIS
SPEECH RECOGNITION
SPACE LAB
AUTO COMMAND
COMPUTER MATCHMAKER
KNIGHT & THE LABYRINTH
STAR SIEGE
TALKING SPELLING QUIZ



SUPER SAVINGS

Single Issue \$8.00
2-5 Issues \$6.00 ea.
6-10 ISSUES \$5.00 ea.
11 or more Issues . \$4.50 ea.
All 72 Issues \$199.00
Purchase 20 or more issues and
receive a free 6 month
subscription.

- Every Issue Contains 10 or More Programs
- Many Machine Language Programs
- Available for COCO I, II and III
- All Programs Include Documentation

- We send 1st Class No Charge
- Personal Checks Welcome!



AND OVER 720 PROGRAMS WITH A BACK ISSUE SALE!

ISSUE #37, JULY 1985

CHESS MASTER
BIBLE 5-7
SHIP WREK ADVENTURE
FILE TRANSFER
FOUR IN A ROW
MARSHY
TAPE CONTROLLER
CATACOMB
AUTO TALK
SGR8PAK

ISSUE #38, AUG. 1985

GOLF PAR3
WIZARD ADVENTURE
KITE DESIGN
ROBOTS
GOMOKU
AMULET OF POWER
LINE COPY UTILITY
DISK PLUMBER
SUPER RAM CHECKER
GRAPHIC HORSE RACE

ISSUE #39, SEPT. 1985

DRUNK DRIVING
GAR MANAGER
SQUEEZE PLAY
SUPER BACKUP
RECIPE MACHINE
ANTI-AIRCRAFT
UNREASON ADVENTURE
TALKING ALPHABET
SUPER VADERS
AUTOMATIC EDITOR

ISSUE #40, OCT. 1985

STAR TREK
HAM RADIO LOG
COCO WAR
DISK LABELER
SHIP WAR
ELECTRIC COST
MULTIKEY BUFFER
NUKE AVENGER
CURSOR KING
SAND ROVER

ISSUE #41, NOV. 1985

GRUMPS
DISK DRIVE SPEED TEST
SOLAR CONQUEST
GAS COST
RIME WORLD MISSION
WUMPLUS
CHARACTER EDITOR
GRAPHIC TEST
GRAPHIC LOOPY
BOLD PRINT

ISSUE #42, DEC. 1985

HOME PRODUCT EVALUATION
YAHTZEE
DISK UTILITY
MACH II
ELECTRONIC BILLBOARD
CAR CHASE
SUPER MANSION ADVENTURE
SLOT MACHINE GIVE AWAY
TEXT BUFFER
TUNNEL RUN

ISSUE #43, JAN. 1986

DUELING CANNONS
WATER COST
ZIGMA EXPERIMENT
MUSICAL CHORDS
SAFE PASSAGE
PASSWORD SCRAMBLER
GUNFIGHT
KEYPAD ENTRY
STYX GAME
PRINTER DIVERT

ISSUE #44, FEB. 1986

HOME INVENTORY
NINE BALL
PRINTER REVIEW
EXPLORER ADVENTURE
SPANISH LESSONS
CROSS FIRE
RAM SAVER
GRAY LADY
JOYSTICK INPUT
COSMIC SWEEPER

ISSUE #45, MAR. 1986

INCOME PROPERTY MGMT.
ELECTRONIC BILLBOARD 2
MOUNTAIN BATTLE
THE FIGHT
COCO KEENO
HOCKEY
LOGICAL PATTERNS
ON SCALE SCREEN
LIBERTY SHIP
SINGLE STEP RUN

ISSUE #46, APRIL 1986

SPECIAL EVENTS REMINDER
DISK LOCK
SMALL BUSINESS MANAGER
BOMB RUN
TANKS
TAR PITS
BASEBALL
NUMBER RELATIONSHIPS
ROULETTE
GLOBAL EDITOR

ISSUE #47, MAY 1986

CHRISTMAS LIST
BLACK HOLE
PITCHING MANAGER
SYMBOLIC DIFF.
BUG SPRAY
DWARE CAPTURE
EASY GRAPHICS
DESERT JOURNEY
SCREEN CONTROL
FULL ERROR MESSAGE

ISSUE #48, JUNE 1986

CHESTER
TV SCHEDULE
BASE RACE
ROMAN NUMERALS
ASTRO DODGE
HIRED AND FIRED
MULTI COPY
AUTO MATE
SCROLL PROJECT
NOISE GENERATOR

ISSUE #49, JULY 1986

COMPUTER I.O.U.
DISK DISASSEMBLER
BACHEK
PACHINKO
STOCK CHARTING
HAUNTED STAIRCASE
CANYON BOMBERS
DRAGONS 1 & 2
GRAPHIC SCROLL ROUTINE
AUTO BORDER

ISSUE #50, AUG. 1986

BUSINESS INVENTORY
D & D ARENA
DISK CLERK
PC SURVEY
TREASURE HUNT
SCREEN GENERATOR
ASTRO SMASH
NFL SCORES
BARN STORMING
SMASH GAME

ISSUE #51, SEPT. 1986

ASSET MANAGER
MONEY CHASE
FISHING CONTEST
RIP OFF
HAND OFF
BUDGET 51
VAN GAR
DOS EMULATOR
MEM DISK
VARIABLE REFERENCE

ISSUE #52, OCT. 1986

ACCOUNTS RECEIVABLE
WORKMATE SERIES
CALENDAR
INVASION
THE TRIP ADVENTURE
FOOT RACE
FLIPPY THE SEAL
SCREEN CALCULATOR
ABLE BUILDERS
SUPER ERROR2

ISSUE #53, NOV. 1986

CORE KILL
LUCKY MONEY
COOKIES ADVENTURE
NICE LIST
SPANISH QUIZZES
PAINT EDITOR
CARVERN CRUISER
SNAP SHOT
MEGA RACE
KICK GUY

ISSUE #54, DEC. 1986

JOB LOG
PEGS
DIGITAL SAMPLING
JUNGLE ADVENTURE
PAINT COCO 3
CONVERT 3
COMPUTER TYPE
PANZER TANKS
MRS PAC
BIG NUM

ISSUE #55, JAN. 1987

GRADE BOOK
MAIL LIST
DOWN HILL
FIRE FOX
JETS CONTROL
GALLOWES
DIR MANAGER
FIRE RUNNER
GRAPHICS BORDER
COSMIC RAYS

ISSUE #56, FEB. 1987

CALENDAR PRINT
CRUSH
GALACTA
OCEAN DIVER
CLUE SUSPECT
WORD EDITOR
ALIEN HUNT
DEMON'S CASTLE
PICTURE DRAW
DIG

ISSUE #57, MAR. 1987

THE BAKERY
EXCHANGED VALLEY ADV.
SAFE KEEPER
WAR 1
BOMB DISABLE
PIANO PLAYER
SPREAD SHEET
SLOT MANEUVER
LIVING MAZE
GEM SEARCH

ISSUE #58, APRIL 1987

ACCOUNTS PAYABLE
PRINTER GRAPHICS
SIMON
PANELING HELPER
MULTI CAKES
GAR RACE
ELECTRONICS 1
BATTLE TANK
DISKETTE VENNY
WEIBDO

ISSUE #59, MAY 1987

GENEALOGY
HOME PLANT SELECTION
CHECK WRITER
HELIFESQUE
KABOOM
NEW PONG
CROQUET
FUNCTION KEYS
ZOOM
ELECTRONICS 2

ISSUE #60, JUNE 1987

JOB COSTING
LABELS
GATCH A CAKE
COCO MATCH
ROBOTS
STREET RACERS
BOWLING 3
ELECTRONICS 3
GRAFIX
KRON

ISSUE #61, JULY 1987

EZ ORDER
SUBMISSION WRITER
KEYS ADVENTURE
WALLPAPER
CHOPPER COMMAND
UNDERSTANDING OPPOSITES
BIT CODE PLOTTING
ELECTRONICS 4
KING PEDE
RAIDER

ISSUE #62, AUG. 1987

PENSION MANAGEMENT
HERB GROWING
CATLOGGER UTILITY
RAIDERS
ALPHABETIZING
U.F.O.
ELECTRONICS 5
RAMBO ADVENTURE
BLOCKS
MULTI SCREEN GAVES

ISSUE #63, SEPT. 1987

GENEALOGIST HELPER
SMART COPY
MAINTENANCE REPORTING
COCO3-COCO 2 HELPER
DIRECTORY PICTURE
SUB ATTACK
SAVE THE MAIDEN
CAVIATOR
ELECTRONICS 6
MONKEY SHINE

ISSUE #64, OCT. 1987

GARDEN PLANTS
FORT KNOX
ELECTRONICS FORMULAS
SNAKE IN THE GRASS
CYCLE JUMP
GEOMETRY TUTOR
WIZARD
GAME OF LIFE
ELECTRONICS 7
FLIGHT SIMULATOR

ISSUE #65, NOV. 1987

TAXMAN
DAISY WHEEL PICTURES
CHILDSTONE ADVENTURE
SIR EGGBERT
CROWN QUEST
GYM KHANA
COCO 3 DRAWER
FOOTBALL
ELECTRONICS 8
CHOP

ISSUE #66, DEC. 1987

ONE ROOM ADVENTURE
OS9 TUTORIAL
RIVER CAPTAIN
SOUND EFFECTS
BETTING POOL
ADVANCE
MATH TABLES
ELECTRONICS 9
LOWER TO UPPER
NOIDS

ISSUE #67, JAN. 1988

AUDIO LIBRARY
SAVE THE EARTH
WEIGHTS AND MEASURES
LOW RES PICTURES
WORD COUNTER
BACARAT
BATTLE SHIP
ELECTRONICS 10
TAPE CONVENIENCE
PENQUIN

ISSUE #68, FEB. 1988

CONFILE
WORD COUNTER
SQUIRREL ADVENTURE
AREA CODES
DRAW POKER
TURTLE RACES
ELECTRONICS 11
MULTI SCREEN
CANDY PRINT
COCO TENNIS

ISSUE #69, MAR. 1988

POLICE CADET
STAMP COLLECTION
BARRACKS ADVENTURE
CITY/TIME
H.P.O./GRAPS
OLYMPICS
H-RES CHESS
ELECTRONICS 12
DOUBLE EDITOR
DOUBLE BREAKOUT

ISSUE #70, APRIL 1988

BLOTTO DICE
SUPER COM
GENESIS ADVENTURE
PLANETS
PHK/WAR
SIGN LANGUAGE
ARX SHOOTOUT
ELECTRONICS 13
MAGIC KEY
SNAP PRINT

ISSUE #71, MAY 1988

SUPER LOTTO
ROBOT ADVENTURE
MAZE
YAHTZEE 3
PHASER
SHAPES & PLATES
STAR WARS
ELECTRONICS 14
PRINTER CONTROL
MAZE 2

ISSUE #72, JUNE 1988

FLYING OBJECTS
THREE STOOGES
HOSTAGE
PROGRAM TRIP
GLADIATOR
US & CAN QUIZ
JEOPARDY
ELECTRONICS 15
COCO 3 PRINT
CTTY COMMUNICATOR

MAIL TO:

T & D Subscription Software
2490 Miles Standish Drive
Holland, Michigan 49424
(616) 399-9648



Name _____
Address _____
City _____ State _____ ZIP _____
Credit Card # _____
Expires _____
TOTAL AMOUNT \$ _____

CIRCLE ISSUES DESIRED

1	9	17	25	33	41	49	57	65
2	10	18	26	34	42	50	58	66
3	11	19	27	35	43	51	59	67
4	12	20	28	36	44	52	60	68
5	13	21	29	37	45	53	61	69
6	14	22	30	38	46	54	62	70
7	15	23	31	39	47	55	63	71
8	16	24	32	40	48	56	64	72

PLEASE CIRCLE
TAPE or DISK

controls the black pieces.) When a small arrow appears on the screen, you are in input mode. The arrow is then moved using the joystick to point to the desired square. Listed below are five play options, which can be used by pressing the corresponding key:

- Q Quit
- R Restarts a new game.
- N Next player
- 1 1 joystick
- 2 2 joysticks

The N command is extremely useful for correcting mistakes. For example, if you moved P-K4, intending a P-KB4, press N after the move is made. This will give control back to the same player. Simply move to the intended square, and no harm is done. (However, if you make an accidental capture, the captured piece *cannot* be recovered.) Castling can be accomplished the same way.

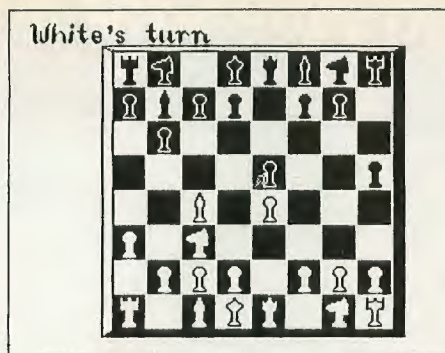

The only rule in *Chess Set* is that you must not move one of your pieces to a square containing another of your own pieces. After a moment's thought, you will realize this means you can make illegal moves. There are two reasons for this option: (1) You can make illegal moves with a real set, and (2) the processing time for determining a move's legality would be too long to be convenient.

To move a piece, point the arrow to the piece you want to move and press the fire button. Then, point to the square you want the piece moved to and press the fire button. Captures are sensed automatically, and captured pieces are taken from the board.

When a pawn reaches its eighth rank, you will be informed by a message on the text screen. Press any key and the board will again be displayed, this time with a rook, knight, bishop, and queen to the left of the board. Use the joystick to point to the piece desired, press the fire button, and the pawn is promoted.

When you wish to end the game, simply press Q to return to BASIC, or R to begin a new game. Enjoy the game, and remember to keep your king safe!

(Questions or comments regarding this program may be directed to the author at 4815 Marrison Place, Indianapolis, IN 46226. Please enclose an SASE when requesting a reply.) □

✓	7	216
	13	102
	21	230
	28	180
	END	155

The listing: CHESS

```

1 'CHESS SET
  BY JOEL F. KLEIN
16K ECB, 1 JOYSTICK REQUIRED
ADDRESS CORRESPONDANCE TO
K&R ELECTRONICS, 4815 MARRISON
PL., INDPLS., IN 46226
2 CLS: CLEAR255: PCLEAR4: PMODE4, 1:
PCLS1: DIMA$(5), A(., 2), B(8, 8), C(1
, 15), BT(., 15), WT(., 15): D$=""
"
3 B$="CØBM4, ØG2DNG2D6GE2U7BR3D4N
RD3G2EU7ERERDRDRDLG2FRFLFLDLGL2B
R7EU7END7EBF4NRG2D2FNU3FERU4FD3F
BE5BR2LULGND3GD2FRDRE2BF2EU7E2GD
7UE2REBG3RDRDRD"
4 W$="CØBMØ, 1ERD9FNU9RERNU5RDREU
7END7EBR3DGD8EU6D4E3RDRD4FU4BE4H
EDRBD4HD5GHRU4BEBR3NR5R2NU3D4FNU
9ED2E2BFBR7GL2ULULNU3ENR3U3R3DRD
2"
5 T$="CØBM7Ø, ØD9HU4NU3L2R5BD5NGN
LNHEBE2BU2ND5RD6RE3ND2U3RD6REBEB
U3ERD6EU4RURF2BEBRERD6RU5RURF2ND
3RD4RECL"
6 C$="CØBM189, 7G3L4ULNU6HU5E3GFD
NGFEUNHEFREBF3D2F2HU4ERFD4NLRNU3

```

```

FBFBDEU6NHRD5ERE2UGU2LULBR5NR5R2
NUD4FNU7ED2E2BE3NUD4FNU6RE3ND2U3
RD6REBEBU3ERD6EU4RURF2BF3BR5GL2U
LU2NR3U2LND3ER3DRD2BF4DLUBU2U7RD
7"

```

```

7 PRINT@1Ø7, "CHESS SET": PRINT: P
RINT: PRINTD$ "BY JOEL F. KLEIN": P
RINT: PRINTD$ " MARCH 1988": PRIN
T: PRINT: PRINT: PRINT " ONE MOM
ENT, PLEASE ..."
8 FORJ=.TO7: FORK=.TO7: A=- (A=.) : C
OLORA: LINE (48+K*2Ø, 16+J*2Ø) - (66+
K*2Ø, 35+J*2Ø), PSET, BF: NEXT: A=- (A
=.) : NEXT: DRAW"CØBM42, 12R172NM-6,
+3D168L172U168M+6, +3R16ØD161L16Ø
NM-5, +4U162": PAINT(212, 44), ., .
9 DRAW"C1": LINE(., .) - (42, 11), PSE
T, BF: DRAW"CØBM46, 5ENH2U2LURBF3BD
5RDR2EULUL2ULUER2DR": DRAW"XB$: XT
$: " : GET(., .) - (42, 1Ø), BT, G: LINE(
., .) - (42, 11), PSET, BF: DRAW"XW$: " : G
ET(., .) - (42, 1Ø), WT, G
1Ø RESTORE: FORJ=.TO5: READA$(J) : N
EXT: FORJ=.TO7: READB(J, .), B(J, 1),
B(J, 6), B(J, 7) : NEXT: FORJ=.TO7: FOR
K=2TO5: B(J, K)=12: NEXT: NEXT: FORJ=
.TO15: C(., J)=48+J: C(1, J)=8*( (J>7
) - (J<8) ) +J: NEXT: JN=1: BN=6528Ø
11 FORP=.TO1: FORPN=.TO15: GOSUB3Ø
: NEXT: NEXT: SCREEN1, . : SOUND2ØØ, 2
12 'MAIN GAME LOOP
13 P=- (P=.) : IFP=. THENPUT(., .) - (4
2, 1Ø), WT, PSETELSEPUT(., .) - (42, 1Ø
), BT, PSET
14 GOSUB26: IF (P+1) *6>B(X, Y) ANDP*
6-1<B(X, Y) THENSX=X: SY=Y: GOTO15EL

```



```

SESOUND1,3:GOTO14
15 GOSUB26:IFB(X,Y)>P*6-1ANDB(X,
Y)<P*6+6THENSOUND1,3:GOTO15 ELSE
DX=X:DY=Y
16 PP=-(P=.):IFB(DX,DY)>PP*6-1AN
DB(X,Y)<PP*6+6THENDRAW"XC$;C1":P
LAY"T3V21L12O3CEGL8O4CL12O3AL4O4
C":LINE(180,)-(244,11),PSET,BF:
X=DX:Y=DY:PP=P:P=-(P=.):GOSUB31:
P=PP:C(-(P=.),PN)=72:B(DX,DY)=12
17 IFY+P=P*8ANDINT(B(SX,SY)/6)=B
(SX,SY)/6THEN20
18 SOUND150,1:C=-((INT(SX/2)=SX/
2)=(INT(SY/2)=SY/2)):COLORC:LINE
(49+SX*20,16+SY*20)-(66+SX*20,35
+SY*20),PSET,BF:C=-((INT(DX/2)=D
X/2)=(INT(DY/2)=DY/2)):COLORC:LI
NE(49+DX*20,16+DY*20)-(66+DX*20,
35+DY*20),PSET,BF
19 X=SX:Y=SY:GOSUB31:B(DX,DY)=B(
SX,SY):B(SX,SY)=12:C(P,PN)=DX+DY
*8:GOSUB30:GOTO12
20 PLAY"T2V31O3L12DDDP32L2A":CLS
:PRINT@128,D$" PAWN AT EIGHTH",
D$"RANK.YOU MAY NOW",D$"PROMOTE
IT TO A",D$"PIECE OF HIGHER",D
$"VALUE. PRESS ANY",D$"KEY TO DO
SO.":GOSUB25:CLS:SCREEN1,.
21 FORJ=1TO4:X=2:Y=26+J*20:DRAW"
BM0,0BR=X:BD=Y:C0XA$(J);":PAINT(
X+10,Y+10),-(P=.),. :NEXT
22 J=JOYSTK(.):J=INT(JOYSTK(-2*(
JN=2ANDP=1)+1)/16):H=2:V=46+J*20
:IFPEEK(BN)=126ORPEEK(BN)=254ORP
EEK(BN)=253THEN24
23 GET(H,V+11)-(H+7,V+19),A,G:DR
AW"BM0,0BR=H:BD=V:BRBD18C1E3FEU2
EULGL2GFG3RC0E5GND2L2":PUT(H,V+1
1)-(H+7,V+19),A,PSET:IFPEEK(BN)=
126ORPEEK(BN)=254ORPEEK(BN)=253T
HEN24ELSE22
24 J=J+1:B(SX,SY)=J+P*6:DRAW"C1"
:LINE(.,26)-(21,126),PSET,BF:GOT
O18

```

```

25 K$=INKEY$:IFK$=""THEN25ELSE
TURN
26 X=INT(JOYSTK(-2*(JN=2ANDP=1)
)/8):Y=INT(JOYSTK(-2*(JN=2ANDP=1)
+1)/8)
27 H=48+X*20:V=16+Y*20:GET(H,V+1
1)-(H+7,V+19),A,G:DRAW"BM0,0BR=H
;BD=V:BRBD18C1E3FEU2EULGL2GFG3RC
0E5GND2L2"
28 K$=INKEY$:IFK$=""THEN29ELSE
SOUND100,1:IFK$="Q"THENCLS:ENDE
LSEIFK$="N"THENPUT(H,V+11)-(H+7,
V+19),A,PSET:GOTO13ELSEIFK$="R"
THEN7ELSEIFK$="1"THENJN=1ELSEIFK$
="2"THENJN=2ELSE SOUND1,1:PUT(H,
V+11)-(H+7,V+19),A,PSET:GOTO27
29 IFPEEK(BN)=126ORPEEK(BN)=254O
RPEEK(BN)=253THENPUT(H,V+11)-(H+
7,V+19),A,PSET:SOUND100,1:RETUR
NELSEJ=X:K=Y:X=INT(JOYSTK(-2*(JN
=2ANDP=1)/8):Y=INT(JOYSTK(-2*(JN
=2ANDP=1)+1)/8):IFX=J ANDY=K THE
N28ELSEPUT(H,V+11)-(H+7,V+19),A,
PSET:GOTO27
30 PO=C(P,PN):Y=INT(PO/8):X=PO-Y
*8:NP=B(X,Y)+6*(P=1):C=-((INT(X/
2)=X/2)=(INT(Y/2)=Y/2)):C=-(C=.)
:X=48+X*20:Y=16+Y*20:DRAW"BM0,0B
R=X:BD=Y:C=C:XA$(NP);":PAINT(X+1
0,Y+10),-(P=.),C:RETURN
31 FORJ=.TO15:IFX+Y*8=C(P,J)THEN
32ELSENEXT:STOP
32 PN=J:FORJ=.TO.:NEXT:RETURN
33 DATA BF6D2F2D5G2DR7UH2U5E2U2H
2L3G,BF2BR3D6R2FD6G2DR7UH2U6ER2U
6DGL2HULDGL2,BF5R2ER2E2FDFD6L2GD
3F2DL7UE2U5HL3HLUER
34 DATA BR9BD2DGDGD3FD5G2DR7UH2U
5EU3HUHU,BR9BD2DG2LGDF3D5G2DR7UH
2U5E3UHLH2U,BR9BD2DG2HD4F2D5G2DR
7UH2U5E2U4GH2U
35 DATA 7,6,0,1,8,6,0,2,9,6,0,3,
10,6,0,4,11,6,0,5,9,6,0,3,8,6,0,
2,7,6,0,1

```

CoCo Cat by Logan Ward



CoCo Gallery



Lighthouse

Brad Bansner

Brad, a high school student in Wyomissing, Pennsylvania, used *Color Max Deluxe* to develop this beautiful scene.

Honorable Mention

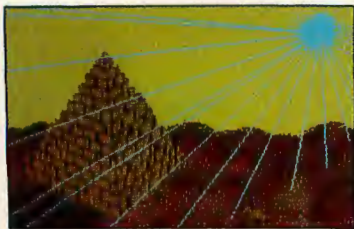

Pyramid

Andrew Wright



Owl

Wally Mayes

This graphic of an ancient Egyptian tomb was developed with *CoCo Max III*. Andrew lives in Conroe, Texas.

Wally, of Hamilton, Ohio, used *CoCo Max III* to develop this view of the night bird. Some of his hobbies include archery and guitars.

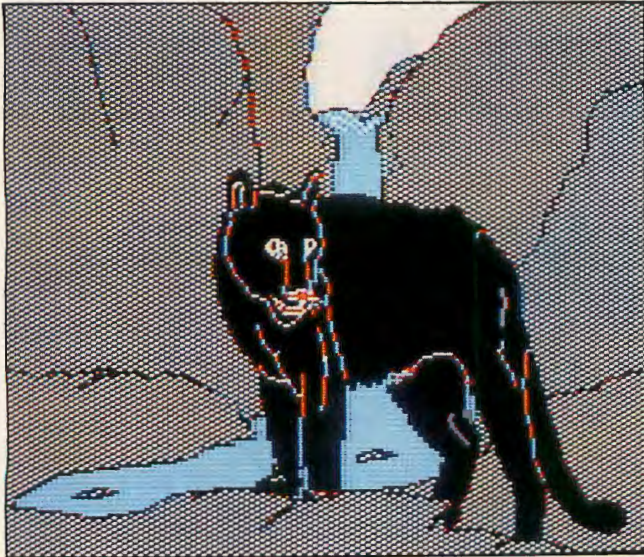

Panther

Serge Beaudry



This wild beast was generated with *CoCo Max II*. Serge lives in St-Polycarpe, Quebec, and enjoys many programs, such as *CoCo Max II* and *III*, *Lyra* and *Iron Forest*.



Sharks

Howard C. Rouse

CoCo Max III was used to create these frightening marine creatures. Howard lives in Ocala, Florida.

SHOWCASE YOUR BEST! You are invited to nominate original work for inclusion in upcoming showings of "CoCo Gallery." Share your creations with the CoCo Community! Be sure to send a cover letter with your name, address and phone number, detailing how you created your picture (what programs you used, etc.) and how to display it. Also, please include a few facts about yourself.

Don't send us anything owned by someone else; this means no game screens, digitized images from TV programs or material that's already been submitted elsewhere. A digitized copy of a picture that appears in a book or magazine is *not* an original work.

We will award two first prizes of \$25, one for the CoCo 3 and one for the CoCo 1 and 2; one second prize of \$15 and one third prize of \$10. Honorable Mentions may also be given.

Please send your entry on either tape or disk to the CoCo Gallery, THE RAINBOW, P.O. Box 385, Prospect, KY 40059. Remember, this is a contest and your entry will not be returned.

— Angela Kapfhammer, Curator

A program to help you compare
disk files for duplicates

COCO TAKES A HINT

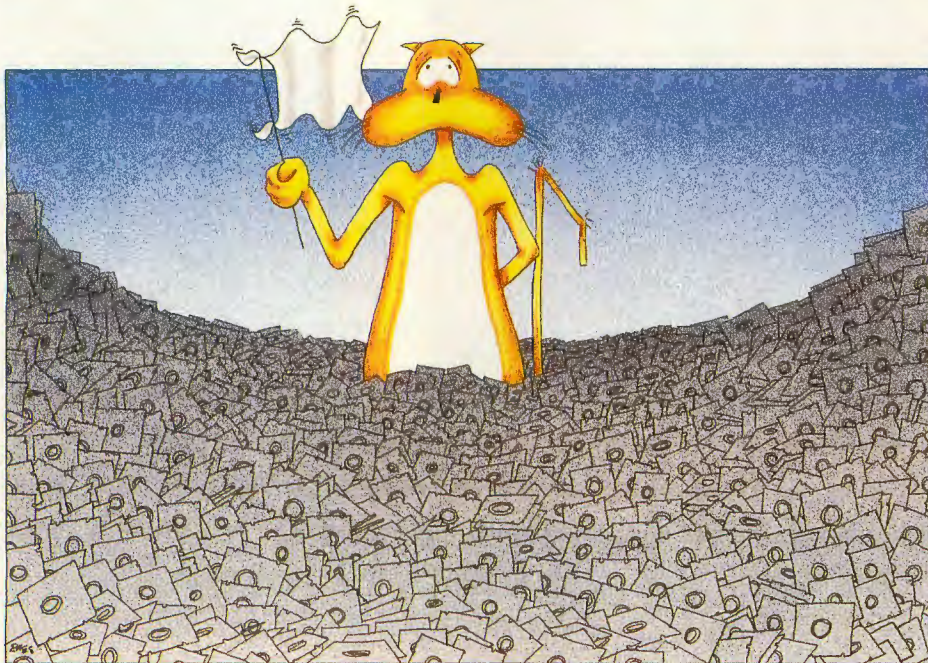

By Dennis H. Weide

You've got three disk drives and have been writing and keying in programs like crazy. With all the bulletin boards you've been accessing, you can't keep track of all the programs you now have. About 300 disks are lying around, filled with all sorts of duplicate programs. To confuse the issue even more, many different programs have the same names, and the same program is saved under different names. You don't know what to save and what to erase. Sound familiar? Well, it does to me, so I wrote a program that helps me determine which are duplicate files.

Filecomp is a machine language program that compares disk files much the same as the `COMP` command in the

Dennis Weide is a communications technician for AT&T in Albuquerque, New Mexico, where he programs AT&T and IBM PCs. He enjoys making toys and teaching computer programming.

IBM PC and compatibles. It prompts you for two filenames, then reads the files to determine their size. If the files are not the same size, the size of each file will be reported on the screen and the program will end. If the files are the same size, the program compares them byte for byte, counts the number of mismatches between them, and reports the number of mismatches and the size of each file on the screen. If no mismatches are reported, then the file contents are identical.

To use the program, first protect the memory where the *Filecomp* program will load by keying in and entering `CLEAR 200,&H4E20`. Then type `LOADM "FILECOMP"`, press `ENTER`, type `EXEC` and press `ENTER` again to load and execute *Filecomp*. Enter the names of the files to be compared at the prompts. The program can compare files on any drive, so you must include the drive number (0 through 3) in the filename even if you only have a one drive system.

The listing: FILECOMP

```
PROGRAM FILECOMP(INPUT,OUTPUT);

(* BY DENNIS H. WEIDE *)
(* COMPARE DISK FILES *)
(* TO VERIFY IF THEY *)
(* ARE EXACT COPIES *)

VAR FILE1,FILE2:TEXT;
    FILENAME1,FILENAME2:STRING;
    MISMATCH,SIZE1,SIZE2:INTEGER;
    FILECHAR1,FILECHAR2:CHAR;

PROCEDURE FILESIZE(VAR FILETOREAD:STRING;VAR FSIZE:INTEGER);

(* READ FILE SIZE *)

VAR INFILE:TEXT;
    CHARACTER:CHAR;

BEGIN
    FSIZE:=0;
    RESET(INFILE,FILETOREAD);
    WHILE NOT EOF(INFILE) DO BEGIN
        READ(INFILE,CHARACTER);
        FSIZE:=SUCC(FSIZE);
    END; (*WHILE*)
END; (*PROC*)

(* MAIN PROGRAM *)

BEGIN
    SIZE1:=0;
    SIZE2:=0;
    MISMATCH:=0;
    PAGE;
    WRITE('ENTER FILE1 > ');
    READLN(FILENAME1);
    WRITE('ENTER FILE2 > ');
    READLN(FILENAME2);
    WRITELN;
    FILESIZE(FILENAME1,SIZE1);
    FILESIZE(FILENAME2,SIZE2);
    IF SIZE1=SIZE2 THEN BEGIN
        RESET(FILE1,FILENAME1);
        RESET(FILE2,FILENAME2);
        WHILE NOT EOF(FILE1) DO BEGIN
            READ(FILE1,FILECHAR1);
            READ(FILE2,FILECHAR2);
            IF FILECHAR1<>FILECHAR2 THEN MISMATCH:=SUCC(MISMATCH);
        END; (*WHILE*)
        IF MISMATCH=0 THEN
            WRITELN('NO MISMATCHES');
        IF MISMATCH=1 THEN
            WRITELN(MISMATCH,' MISMATCH');
        IF MISMATCH>1 THEN
            WRITELN(MISMATCH,' MISMATCHES');
    END; (*IF*)
    WRITELN;
    WRITELN(FILENAME1,' ',SIZE1,' BYTES');
    WRITELN(FILENAME2,' ',SIZE2,' BYTES');
END.
```

Three examples follow, the first comparing the file on Drive 0 to one of the same name on Drive 2:

```
ENTER FILE1 > FILECOMP/BIN:0
ENTER FILE2 > FILECOMP/BIN:2
```

The next example compares two files, with the same name but different extensions, that reside on the same drive:

```
ENTER FILE1 > FILECOMP/BIN:0
ENTER FILE2 > FILECOMP/PAS:0
```

The final example compares two files with different names on different drives:

```
ENTER FILE1 > FILECOMP/BIN:3
ENTER FILE2 > OTHRFIL/BAS:0
```

The program can even compare the same file to itself on the same drive. This is a valid way to check file size.

“Many different programs have the same names, and the same program is saved under different names. You don’t know what to save and what to erase. Sound familiar?”

Filecomp was written and compiled using Deft PASCAL *Workbench*. Only one non-standard PASCAL statement was used (PAGE) in the program to clear the screen. Therefore, this program can be written using any PASCAL compiler capable of compiling standard PASCAL. It loads and executes at address \$4E20 and ends at address \$6099. For those of you who have a PASCAL compiler, you can type in the listing and compile it. For those who don't have a compiler, the binary file will appear on this month's RAINBOW ON TAPE and DISK.

(Questions or comments concerning this program may be directed to the author at 14201 Marquette N.E., Albuquerque, NM 877123. Please enclose an SASE when requesting a reply.) ☺



An old favorite with some added bells and whistles

Bingo

the CoCo Way

By Bruce K. Bell, M.D.

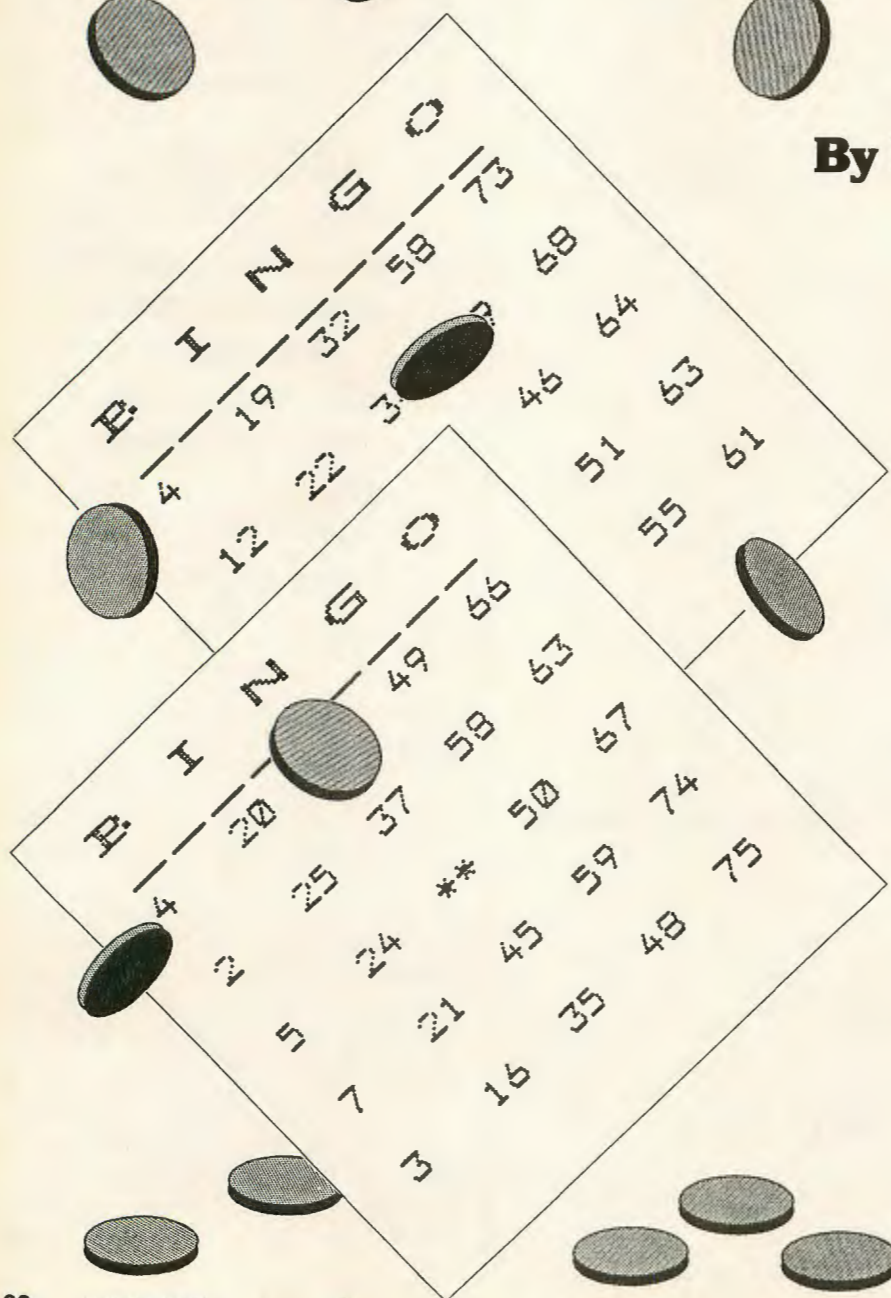

One of my favorite things to do is to take traditional games and adapt them for use with my CoCo. Usually those adaptations include a few enhancements as well. That's what I've done with *Talking Bingo*.

Talking Bingo includes several advantages over a "store-bought" Bingo game or other computer Bingo games I've seen. For example, not only does CoCo select and display the Bingo numbers in bold colorful characters, but it also calls them out. You'll need a Tandy Speech/Sound Cartridge for this. It also constantly displays all the numbers that have been called during the current game. And you needn't go out and buy Bingo cards, because *Talking Bingo* will print out disposable cards for you. If you are alone on a rainy day, CoCo will challenge you to a few quick games. So let's get *Talking Bingo* up and running.

You'll need a CoCo 1, 2, or 3 with at least 16K of memory and Extended Color BASIC. The Tandy Speech/Sound Cartridge is optional, but it's needed if

Bruce Bell is an optometric physician who spends hours using programs he finds in RAINBOW and programming his CoCo for home and office use.

you want the numbers called aloud. You'll need an 80-column printer if you want to print your own Bingo cards.

Once you've typed, debugged and saved the program you are ready to run it. On some older CoCos you may get an error after running; if so, just type RUN again.

At the initial menu you are given four choices:

1. Play Bingo
2. Computer Challenge
3. Print Bingo Cards
4. Exit to BASIC

Press the number corresponding to your choice. There may be a momentary delay after you press your choice and before the function is executed. Let's look at these one at a time.

Play Bingo

The screen will clear and the first randomly chosen number will appear in the center of the screen. Simultaneously the number will be called out. A second clock to the right of the screen clicks off ten seconds before the next number is chosen and displayed. After each number is displayed, it will appear in

normal Color Computer characters on the screen. You may refer to these at any time during the game.

You've probably also noticed several items at the bottom of the screen. These are to remind you that you may at any time during the game press M to end the game and return to the menu, or press T to toggle between enabling and disabling the Speech/Sound Cartridge's speech capabilities. You may also press P to pause in the game. This is useful if you want to go back and compare your cards to those numbers already called. When you "Bingo," press B; you will be prompted to enter the five numbers you've used to do so. Press F if one of the numbers is the free space. Enter your numbers by typing the letter followed by the number: for example, B3 or O71. If you enter a number that has not been called, a series of question marks appear, requesting you to re-enter. Press M to end the game and return to the menu, or C to continue the same game where you left off.

After you've Bingoed and won the game, press M to return to the menu or C to continue where you left off. This allows you to have a second-place Bingo card.

Line Number	Description
000-010	Initialize program
100-120	Main Menu
200-250	Randomly select Bingo numbers
300-350	Input numbers for Bingo
400-480	CoCo creates and plays its cards
500-525	Print Bingo cards
600-620	Create Bingo cards
700	Ends game
800-855	Speech routine
900-945	Subroutines
1000-1070	Data
1100	Clears memory

Table 1

Computer Challenge

This option operates exactly the same as Play Bingo, except that CoCo also selects three cards and plays against you. Don't worry! CoCo won't cheat! After you have selected this option, there is a momentary pause while CoCo creates its three cards. Then the game begins, played as above with the following differences: When you select Menu,



CINSOFT
PROGRAMS • PERIPHERALS • SUPPLIES • SERVICE

Fast Delivery...
Friendly Service

Now in our 6th year!



Avatex Modems

SUPER VALUE!

Avatex 1200e \$ 99
with Coco Cable 109

Reviewed in April, 1988 Rainbow!



Avatex 1200e, Cable
AUTOTERM... \$139

SUPER SPEED!

Avatex 2400 \$219
with Coco Cable 229
(Coco 3 only)
with RS-232 Cable* 245



Avatex 2400, Cable
AUTOTERM... \$259

*Coco 1, 2 requires Deluxe RS-232 Pak

• Call • • Shop by Modem •

513-396-SOFT 513-396-SHOP





2235 Losantville, Cincinnati, OH 45237
SHIPPING will be charged at our ACTUAL COST
Ohio residents add 5.5% Sales Tax COD add 2.50

TANDY COMPUTER DISCOUNTS

COLOR COMPUTERS

26-3334 CoCo 3	165.00
26-3215 CM-8 color monitor	259.95

PRINTERS

26-2802 DMP 106	179.95
26-2808 DMP 440	599.00
26-1280 DMP-130	279.00
Complete line of Tandy (Daisy Wheel) print wheels	

MSDOS COMPUTERS

25-1053 TANDY 1000 HX	599.00
25-1600 TANDY 1000 TX	999.95
25-4071 TANDY 3000 HL	1,300.00
25-1023 CM-5 color monitor	249.95
25-1020 VM-4 Monochrome monitor	110.00

We Carry the Complete Line of Tandy Computer Products at Discount Prices

**CALL FOR A FREE PRICE LIST 800-257-5556
IN N.J. CALL 609-769-0551**

WOODSTOWN ELECTRONICS

Rt. 40 E. WOODSTOWN, N.J. 08098

Bingo, Pause, or Talk, there is a pause before the function is executed. This is because CoCo may be checking its cards when you press the key. CoCo doesn't forget; it just finishes checking its cards before carrying out your command.

When CoCo Bingos, its winning card appears in the center of the screen. Called numbers appear in reverse characters, and the winning row is marked in red. You may now return to the Menu and continue the same game or, by pressing V, see all three of CoCo's cards. This is the only time you may see them. Note that if CoCo has won the game and you choose to continue play, CoCo does not continue with you — it stops playing.

Print Bingo Cards

The cards created in *Talking Bingo*

are printed on standard paper in four rows of three cards, or 12 cards per page. The idea is that each player plays with three cards at a time and marks with a pen or pencil the numbers on his cards as they are called. After selecting this option, you are asked for the number of rows of cards you want to print. Remember that there are four rows per page. Set the top edge of your paper at the print-head and follow the prompts from here.

I have a DMP 200 and CGP-220, both of which use CHR\$(27)CHR\$(14) to call expanded print and CHR\$(27)CHR\$(15) to recall normal print. If your printer is different, you will need to change lines 515 and 525 accordingly.

Exit to BASIC

This, of course, returns you to BASIC

but does not erase the program from memory.

One final note about the Speech/Sound Cartridge. If you don't have one, no modifications are necessary. Just type in the program as it is and run it. You may, however, want to toggle the Talk function (by pressing T) to enable the alternate "beeps" that alert you when a new number appears.

I hope you enjoy playing and studying *Talking Bingo*. Table 1 includes a breakdown description of each of the program modules within the program. Let me know if I can be of any help.

(Questions or comments regarding this program may be addressed to the author at 137 Samanda Circle, Rockmart, GA 30153. Please enclose an SASE when requesting a reply.) □

✓	12081	525144
	305160	85059
	34519	1000112
	450112	END230

The listing: BINGOTLK

```

0 'BINGO 2.0; <C> BRUCE BELL 198
6,87; 16KECB; this program is no
nwarranted!!!
5 POKE3584,0:IFPEEK(33021)=50THE
NWIDHTH32:POKE3584,2
10 FORK=1TO8:PRINT,"BINGO",,"bin
go",:NEXT:GOTO1100
100 POKE65495+PEEK(3584),0:PRINT
@0,CHR$(181)" ONE MOMENT "CHR$(1
86);:CLEAR550:DIML$(14),N$(15),A
(75),B(2,4,5):R=RND(-TIMER):M1=&
HFF00:M2=&HFF7E:GOSUB920:DEF FNL
(N)=INT(ABS(N-1)/15)+1
105 FORK=1TO14:FORX=1TO15:READD:
L$(K)=L$(K)+RIGHT$(STR$(D),2):NE
XTX,K:FORK=0TO15:READN$(K):NEXT:
POKE65494+PEEK(3584),0
110 CLS0:FORK=0TO63:SET(K,2,4):S
ET(K,11,4):NEXT:R=32:L$="TALKING
BINGO BY BRUCE BELL":PRINT@
19,"by";CHR$(128)"bruce"CHR$(128
)"bell";:GOSUB850:GOSUB900:FORK=
1TO75:A(K)=0:NEXT:Z=0:F=0
115 PRINT@224,TAB(6)"1. PLAY BIN
GO"TAB(38)"2. COMPUTER CHALLENGE
"TAB(38)"3. PRINT BINGO CARDS"TA
B(38)"4. EXIT TO BASIC":L$="WHAT
IS YOUR PLEASURE?":PRINT@388,L$
;:GOSUB850

```

```

120 GOSUB910:CH=Q:ONQ GOTO200,40
0,500,700:R=RND(7)*16:GOSUB900:G
OTO120
200 L$="GGET READY":GOSUB850:CLS
0:L$="bingo":GOSUB915:GOSUB925
205 IFQ$="B"THEN300ELSEN=RND(75)
:IFA(N)>0THEN205ELSER=RND(6)*16:
L=FNL(N)
210 P=200:L=L$(L):GOSUB905:R=R+
16:N$=RIGHT$(STR$(N),2)
215 FORK=1TOLEN(N$):X$=MID$(N$,K
,1):IFX$=" "THENL$=""ELSEL$=L$(V
AL(X$)+5)
220 P=200+6*K:GOSUB905:NEXTK
225 TIMER=0:TALK=1:IFT=0GOSUB800
ELSESOUND100,1
230 IFCH=2THEN410
235 GOSUB910:GOSUB930:IFDLAY=5AN
DTALK=1GOSUB800:TALK=0:GOTO235EL
SEIFDLAY THEN235
240 PRINT@Z,MID$("BINGO",L,1);RI
GHT$(STR$(N),2);CHR$(128);
245 A(N)=Z+3:Z=Z+4:IFZ=160THENZ=
320
250 GOTO205
300 IFWV GOSUB465:GOTO330ELSEPRI
NT@251,"bingo";:GOSUB945:PRINT@4
81," M=MENU F=FREE C=CONTINU
E ";
305 FORK=0TO4:P=197+K*16:PRINT@P
,"";:INPUTQ$
310 PRINT@219+INT(K/2)*32,"bingo
";:IFQ$="M"THENK=5:NEXT:GOTO100
315 IFQ$="C"THENK=5:NEXT:GOSUB94
5:GOSUB925:F=0:FORK=1TO75:IFA(K)
>1000THENA(K)=A(K)-1000:PRINT@A(
K),CHR$(128);:NEXT:GOTO205ELSENE
XT:GOTO205
320 IFQ$="F"THENIFF=1THEN345ELSE

```



```

F=1:NEXTK:GOTO33Ø
325 N=VAL(MID$(Q$,2)):IFA(N)=ØOR
A(N)>1ØØØTHEN345ELSEPRINT@A(N),C
HR$(127);:A(N)=1ØØØ+A(N):IFT THE
NSOUND2ØØ,1:NEXTK ELSEL$="CHECK"
:GOSUB85Ø:NEXTK
33Ø PRINT@48Ø,STRING$(31,128);:P
RINT@48Ø,"GAME OVER! mENU cONTIN
UE";:L$="BINGO":GOSUB85Ø:IFCH=2T
HENPRINT" VERIFY";
335 GOSUB91Ø:L$="BINGO":GOSUB915
:L$="bingo":GOSUB915:IFQ$="C"THE
NPRINT@165,STRING$(22,128);:PRIN
T@293,STRING$(22,128);:CH=2-WV:W
V=Ø:FORK=3TO4:GOTO315ELSEIFCH=2
AND Q$="V"THENUU=U:FORU=ØTO2:GOS
UB465:PRINT@48Ø," CARD"U+1":
PRESS <ENTER> "; ELSE335
34Ø GOSUB91Ø:IFQ$=""THEN34ØELSEN
EXTU:U=UU:IFU=3GOSUB945:GOTO33ØE
LSEGOSUB465:GOTO33Ø
345 PRINT@P,"?????";:IFT THENSOU
ND1,5 ELSEL$="PLEASE RE ENTER":G
OSUB85Ø
35Ø K=K-1:NEXTK
4ØØ L$=" ONE MOMENT PLEASE... ":
PRINT@388,L$;:GOSUB85Ø:GOTO6ØØ
4ØØ FORK=ØTO75:A(K)=Ø:NEXT:GOTO2
ØØ

```

```

41Ø FORK=ØTO2:FORC=ØTO4:FORR=ØTO
4:IFB(K,C,R)=N THENB(K,C,R)=B(K,
C,R)+5ØØ
415 GOSUB93Ø:IFDLAY=5ANDTALK=1GO
SUB8ØØ:TALK=Ø
42Ø NEXTR,C,K:GOSUB91Ø
425 WV=Ø:FORU=ØTO2:FORC=ØTO4:W=Ø
:V=Ø:FORR=ØTO4:IFB(U,C,R)>499THE
NW=W+1
43Ø IFB(U,R,C)>499THENV=V+1
435 NEXTR:GOSUB93Ø:IFW=5THENFORR
=ØTO4:B(U,C,R)=B(U,C,R)+5ØØ:NEXT
R:C=4:NEXTC:GOTO46ØELSEIFV=5THEN
FORR=ØTO4:B(U,R,C)=B(U,R,C)+5ØØ:
NEXTR:C=4:NEXTC:GOTO46ØELSENEXTC
44Ø R=4:W=Ø:V=Ø:FORC=ØTO4:IFB(U,
C,C)>499THENW=W+1
445 IFB(U,C,R)>499THENV=V+1
45Ø R=R-1:NEXTC:GOSUB93Ø:IFW=5TH
ENFORC=ØTO4:B(U,C,C)=B(U,C,C)+5Ø
Ø:NEXTC:GOTO46ØELSEIFV=5THENR=4:
FORC=ØTO4:B(U,C,R)=B(U,C,R)+5ØØ:
R=R-1:NEXTC:GOTO46Ø
455 NEXTU:GOTO235
46Ø WV=5:Q$="B":GOTO24Ø
465 GOSUB945:FORP=165TO293STEP32
:PRINT@P,CHR$(165)STRING$(2Ø,32)
CHR$(17Ø);:NEXT:FORR=ØTO4:P=166+
R*32:FORC=ØTO4:IFB(U,C,R)>999THE

```

Mouse Tales

By Logan Ward



CocoTech **NEW** ULTIMAX

You can use UltiMax as a normal HI-RES joystick interface or switch it to be used with a popular Max III graphics program. The other feature of UltiMax is the option to have a large or small stick area so you can be more accurate with your drawings!

The UltiMax interface is only \$29.95

Or Trade in your original HiRes interface (sent postage prepaid) and get UltiMax for only.....\$14.95

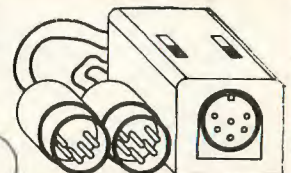

MACPLAY

With MACPLAY and a CoCo 3 you can play MAC sound files (Included on the second diskette) with pure 6 BIT sound quality that the CoCo can produce! Or download other MAC sound files from a computer information service or MAC bulletin board systems to hear even more. Sound files can last for a few seconds or up to 1/2 minute. MAC sound files included on the second diskette contain excerpts from the 3 Stooges to the Road Runner and more!!

MACPLAY is only.....\$ 19.95

Please make check or money order payable to: Thomas E. Keller

Send to:
CocoTech

PA residents 208 Cathy Ann Drive
add 6% sales Reading, PA 19606
tax (215)-779-7768

Please allow
1 to 3 weeks
for delivery

Shipping and handling:
USA and Canada add \$2.50
Other countries add \$5.00

Sorry no
credit cards
YET!

** We now handle C.O.D.'s **

```

NB=B(U,C,R)-1000:D=2ELSEIFB(U,C,
R)>499THENB=B(U,C,R)-500:D=1ELSE
B=B(U,C,R):D=0
470 IFD=0THENB$="BINGO"ELSEB$="b
ingo":IFD=2THENPRINT@P,CHR$(186)
;:IFB THENPRINT@A(B),CHR$(127);
475 IFB=0THENPRINT@P+1,"fre";ELS
EPRINT@P+1,USINGMID$(B$,FNL(B),1
)+"##";B;:IFD THENFORK=1TO2:POKE
1025+P+K,PEEK(1025+P+K)-64:NEXT
480 P=P+4:NEXTC,R:RETURN
500 PRINT@386,"HOW MANY ROWS OF
CARDS";:INPUTQ
505 PRINT@416,"PREPARE PRINTER A
ND PRESS enter";:INPUTQ$:IF(PEEK
(65314)AND1)=1THENPRINT@416,"PRI
NTER IS NOT READY!!!":SOUND100,1
:FORZ=1TO1000:NEXT:GOTO505
510 FORZ=1TOQ:PRINT#-2:PRINT#-2:
FORK=1TO75:A(K)=0:NEXTK
515 PRINT#-2,CHR$(27)CHR$(14);:'
call expanded print mode (DMP200
)
520 FORK=1TO3:PRINT#-2," B I N
G O ";:NEXT:PRINT#-2
525 FORK=1TO3:PRINT#-2,"
";:NEXT:PRINT#-2,CHR$(27)CH
R$(15):'cancel expanded print mo
de (DMP200)
600 FORR=0TO4:FORK=0TO2:FORC=0TO
4
605 N=RND(15)+15*C:X=2^K:IF(A(N)
ANDX)<>0 THEN605ELSEA(N)=(A(N)OR
X):IFR=2ANDC=2THENIFCH=2THENB(K,
C,R)=500:NEXTC ELSEPRINT#-2,TAB(
K*26+12)"**";:NEXTC
610 IFCH=2THENB(K,C,R)=N:NEXTC,K
,R:GOTO405ELSEPRINT#-2,TAB(K*26+
C*4+3)N;:NEXTC,K:PRINT#-2:PRINT#
-2:NEXTR
615 PRINT#-2:PRINT#-2:IFZ/4=INT(
Z/4)THENPRINT#-2:PRINT#-2
620 NEXTZ:GOTO1000
700 CLSRND(8):L$="SO LONG!":PRIN
TL$:GOSUB850:END
800 L$=MID$("BINGO",L,1)+" ":IFN
<10THENL$=L$+STR$(N)ELSEIFN<21TH
ENL$=L$+N$(N-10)ELSEIFN/10=INT(N
/10)THENL$=L$+N$(N/10+8)ELSEL$=L
$+N$(INT(N/10)+8)+RIGHT$(STR$(N)
,1)
850 IFT THENRETURNELSEL$=L$+" "+
CHR$(13):FORY=1TOLEN(L$)
855 IFPEEK(M2) AND 128=0 THEN855
ELSEPOKEM2,ASC(MID$(L$,Y,1)):NEX
T
860 RETURN
900 FORA=1TO5:P=59+6*A:L$=L$(A):
GOSUB905:NEXTA:RETURN
905 FORB=1TO21STEP10:PRINT@P,"";
:FORC=0TO9STEP2:PRINTCHR$(R+128+

```

```

VAL(MID$(L$,B+C,2));:NEXTC:P=P+
32:NEXTB:RETURN
910 Q$=INKEY$:IFQ$="M"THEN100 EL
SEIFQ$="T"THENT=(T+1)AND1:PRINT@
507,CHR$(84+T*32);:GOSUB920:RETU
RNEELSEIFQ$="P"THEN935ELSEIFQ$<>"
B"THENQ=VAL(Q$):RETURNELSEIFCH T
HEN240ELSERETURN
915 FORK=0TO2:PRINT@192+K*32,L$;
:PRINT@219+K*32,L$;:NEXT:RETURN
920 POKE&HFF7D,1:POKE&HFF7D,0:PO
KEM1+1,52:POKEM1+3,63:POKEM1+35,
60:RETURN
925 PRINT@480,CHR$(128);"Menu";S
TRING$(4,128);"Bingo";STRING$(4,
128);"Pause";STRING$(4,128);"Tal
k";:IFT THENPRINT@507,"t";:RETUR
NELSERETURN
930 DLAY=10-INT(TIMER/60):PRINT@
251,RIGHT$(STR$(DLAY),2)"SEC";:R
ETURN
935 TI=TIMER:PRINT@481," PRESS
ANY KEY TO CONTINUE ";
940 IFINKEY$=""THEN940ELSETIMER=
TI:GOTO925
945 FORK=197TO261STEP32:PRINT@K,
STRING$(22,128);:NEXT:RETURN
1000 DATA15,12,12,15,0,15,12,12,
12,15,15,3,3,3,15
1005 DATA4,12,15,12,8,0,0,15,0,0
,1,3,15,3,2
1010 DATA15,9,0,0,15,15,0,9,0,15
,15,0,0,9,15
1015 DATA15,12,12,12,8,15,0,1,3,
3,15,3,3,3,7
1020 DATA15,12,12,12,15,15,0,0,0
,15,15,3,3,3,15
1025 DATA0,1,15,0,0,0,0,15,0,0,0
,3,15,3,0
1030 DATA0,4,12,12,15,15,12,12,1
2,12,15,3,3,3,3
1035 DATA12,12,12,15,0,0,4,12,12
,15,3,3,3,3,15
1040 DATA15,0,0,15,0,12,12,12,15
,12,0,0,0,15,0
1045 DATA15,12,12,0,0,12,12,12,1
2,15,3,3,3,3,15
1050 DATA15,12,12,0,0,15,12,12,1
2,15,15,3,3,3,15
1055 DATA0,12,12,12,10,0,0,0,6,0
,0,0,6,0,0
1060 DATA0,15,12,15,0,15,12,12,1
2,15,15,3,3,3,15
1065 DATA15,12,12,12,15,12,12,12
,12,15,0,0,0,0,15
1070 DATATENN,EELLEVEN,TWELLVE,T
HIRTEEN,FORTEEN,FFIFTEEN,SSIXTE
EN,SSEVENTEEN,EIGHT TEEN,NINE TE
EN,TWENTEE,THIRTEE,FORTEE,FIFTEE
,SSIXTEE,SSEVENTEE
1100 PCLEAR1:GOTO1000

```

Get 2 Free Hours*
Sign-Up Today!



Retrieve more online for less with GENie.™

“I’ve really tracked down superior selection and service with GENie. I always knew GENie was ahead of the pack with the Tandy† RoundTable™ Special Interest Group, featuring over 2500 software files, dynamic bulletin boards, lively discussions and “tips” from the experts. And now I can sink my teeth into valuable information services like American Airlines EAASY SABRE™ personal reservation system, discount shopping with Comp-u-store Online,® new and exciting multi-player games and access to Dow Jones News/Retrieval.® And those GENie people are so dog-gone friendly!

You’re barking up the wrong tree if you don’t look to GENie for value, service and selection for your Tandy. Only GENie offers you so much online, for less.”

B.A. Retriever

Services Available	Compare & Save	Pricing**			
		Registration Fee	Monthly Minimum	Non-prime Time Rates	
				300 baud	1200 baud
Electronic Mail • CB • SIGs/User Groups • Travel • Shopping • Finance • Reference Professional • Leisure • Games • News	GENie†	\$29.95	None	\$5.00	\$5.00
	CompuServe	\$39.95	None	\$6.00	\$12.50
	Other	\$49.95	\$10.00	\$8.40	\$10.80

*Get 2 Free Hours with Sign-Up.

Still just \$5 per hour. Get online today!

1. Have your major credit card or checking account number ready.
2. Set your modem for local echo (half duplex)—300 or 1200 baud.
3. Dial 1-800-638-8369. When connected, enter HHH
4. At the U#= prompt enter **XJM1772 ,GENie** then RETURN.

Need help or more information? No modem yet? We can help. In U.S. or Canada call **1-800-638-9636** or write GENie, 401N. Washington Street, Rockville, MD 20850.



We bring good things to life.

**Basic rates and services in effect 1/88 apply in U.S. only. †Non-prime time rates apply Mon.-Fri. 6PM-8AM local time and all day Sat., Sun., and nat'l. holidays. Subject to service availability. Some services offered on GENie may include additional charges. Dow Jones News Retrieval is a registered service mark of Dow Jones & Co., Inc. †Tandy is a registered trademark of Tandy Corporation. **\$10 credit applies. Offer good for 30 days from sign-up.
© 1988 General Electric Company, U.S.A.



You won't even lose any pieces

Child's Play

By Bill Bernico

I remember, as a kid, playing a dice game where the players each got 13 plastic bug parts and shook a die, trying to assemble their own bug first. The problem with that game was that someone kept losing the plastic bug parts, and there never seemed to be enough legs or feelers to go around. When playing *Buggie*, the computer can't lose the pieces. They're always there, safe in CoCo's memory, ready to play.

I should explain the value of the die for you *Buggie* novices. Rolling a one gets you a body. Two is good for a head. Roll a three for eyes (you need two). A four gives you a feeler (again, you need two). Rolling a five allows you to add the tongue. You will need to roll a six a total of 6 times, one for each leg that you will add to your bug. There are 13 parts in all. Once you have all 13, you win. To "roll" the die, simply press any

Bill Bernico is the author of over 200 Color Computer programs and is a frequent RAINBOW contributor whose hobbies include golf, writing music and programming. Bill is a drummer in a rock band and lives in Sheboygan, Wisconsin.

key when your name appears at the top of the screen. It sounds easy — too easy.

Here is the catch.

If you roll a one, you can begin with the body. No other number on the die has any value until a one is rolled. After all, you can't add a head, eyes, feelers, legs or a tongue unless you first have a body to put them on.

Once you have rolled a one, you can get credit for any sixes you roll, adding a leg for each six. Numbers three, four and five are still worthless until you roll a two, which will give you the bug's head. Three, four and five represent eyes, feelers and tongue, in that order. You can't add them unless you first have a head, can you?

All right, so now you have a body (one) and a head (two). From this point, any other number, in any order, will add to your bug. If you roll a number you don't need or can't use, simply pass the die and let the next player try for another piece. That's all there is to it. Have fun!

(Questions or comments concerning this program may be directed to the author at 708 Michigan Avenue, Sheboygan, WI 53081. Please enclose an SASE when requesting a reply.) □

9	191	98	234
30	95	110	157
53	0	120	68
75	25	END	102

The listing: BUGGIE

```

1 'COCO BUGGIE (C) 1988 FROM
  BILL BERNICO SOFTWARE

2 CLEAR500:CLS0:PRINTTAB(10)"COC
O-BUGGIE":FORX=1024TO1055:POKEX,
PEEK(X)-64:NEXTX:PRINT:PRINT"PLA
YER'S NAME MUST BE LESS THAN EIG
HT CHARACTERS EACH":PRINT:INPUT"
PLAYER 1'S NAME";N1$:IFLEN(N1$)>
8THEN2
3 PRINT@192,STRING$(32,143):PRIN
T@224,STRING$(32,143):PRINT@224,
";:INPUT"PLAYER 2'S NAME";N2$:I
FLEN(N2$)>8THEN3
4 POKE65497,0:RGB:HSCREEN2:HCLS4
:HCOLOR8,4:ONBRKGOTO131:DT$="RDL
U2R2D3L3U3F":D$="BL4BUR22D22L22U
22E4R22NG4D22NG4U22L22G4BF3":LR$
="G10D20L4DR5U21E10RG10D20L5DNR6
DR6U22E10RG10
5 HCLS4:HLINE(0,0)-(160,191),PSE

```

```

T,B:HLINE(5,5)-(155,186),PSET,B:
HPAINT(2,2),2,8:HLINE(160,0)-(31
9,191),PSET,B:HLINE(165,5)-(314,
186),PSET,B:HPAINT(167,2),3,8
6 IFP2=13THEN100ELSEGOSUB113:D=R
ND(6):HCOLOR2:PLAY"O2T20B":HPRIN
T(1,1),N1$+",HIT A KEY":EXEC4453
9:HDRAW"BM30,27"+D$:Z=D:GOSUB106
:PLAY"O4T60CBDAEGFC
7 ON Z GOTO 8,12,18,26,34,40
8 HPRINT(10,4),"1=BODY
9 IFB1=1THEN11
10 IFB1=0THEN X=87:Y=93:H=60:GOS
UB114:B1=1:P1=P1+1:GOTO52
11 GOSUB127:GOTO52
12 HPRINT(10,4),"2=HEAD
13 IFH1=1THEN16
14 IFB1=0THEN17
15 IFH1=0THEN H=100:GOSUB115:H1=
1:P1=P1+1:GOTO52
16 GOSUB127:GOTO52
17 HPRINT(3,21),"YOU NEED A BODY
":GOTO52
18 HPRINT(10,4),"3=EYES
19 IFH1=0THEN24
20 IFE1=2THEN25
21 IFE1=0THEN H=113:GOSUB116
22 IFE1=1THEN H=98:GOSUB117:P1=P
1+2

```

FILE TRANSFER UTILITIES

You asked for it at the Chicago RainbowFest -

FILE TRANSFER UTILITIES NOW HANDLE RSDOS DISKS!

Need to transfer text files to and from PC (MSDOS), RSDOS and FLEX disks into your CoCo (OS-9) system? Have text files on a PC (MSDOS) system at work and want to work on them at home on your CoCo?

With GCS File Transfer Utilities you just place the PC (MSDOS), RSDOS or FLEX disk into your CoCo disk drive - enter a simple command and the file is copied into a CoCo OS-9 file. File transfer back to PC (MSDOS), RSDOS and FLEX disks is just as simple.

PCDIR	directory of PC disk	RSDIR	directory of RSDOS disk
PCDUMP	display PC disk sector	RSDUMP	display RSDOS disk sector
PCREAD	read PC file	RSREAD	read file from RSDOS disk
PCWRITE	write file to PC disk	RSWRITE	write file to RSDOS disk
PCRENAME	rename PC file	FLEXDIR	directory of FLEX disk
PCDELETE	delete PC file	FLEXDUMP	display FLEX disk sector
PCFORMAT	format PC disk	FLEXREAD	read FLEX file
		FLEXWRITE	write file to FLEX disk

Extensive Options Single, double sided disks. 40 or 80 track floppy drives. 8 or 9 sectors. First level sub-directories - PC (MSDOS). FLEX transfers binary files also.

Requires OS-9 (Level 2 for MultiVue), 2 drives (one can be hard), MultiVue for MultiVue version, SDISK (SDISK3 for MultiVue) - see D.P. Johnson ad for SDISK

GSC File Transfer Utilities for CoCo - MultiVue version \$54.95

GSC File Transfer Utilities for CoCo - Standard version \$44.95

All diskettes are CoCo OS-9 format. Orders must be prepaid or COD, VISA/MC accepted, add \$1.50 S&H, additional charge for COD.

GRANITE COMPUTER SYSTEMS

Route 2 Box 445 Hillsboro, N.H. 03244
(603) 464-3850



OS-9 is a trademark of Microware Systems Corporation and Motorola Inc.
MS-DOS is a trademark of Microsoft Corp. FLEX is a trademark of TSC, Inc.

As EASY As WRITING A CHECK

THAT'S HOW EASY IT IS TO:

- .. RECONCILE YOUR CHECK BOOK
- .. USE A BUDGET
- .. KEEP TRACK OF CASH EXPENSES
- .. TRACK CHECK, ATM & CASH EXPENSES BY TYPE OR PAYEE
- .. SUMMARIZE YOUR EXPENSES FOR TAX TIME - OR FOR ANY OTHER PURPOSE



GREAT DOCUMENTATION
ON SCREEN MENU'S & PROMPTS
DEFINATELY USER FRIENDLY



REQUIRES 32K CoCo 1, 2, or 3 AND SINGLE DISK DRIVE
REVIEWED IN DECEMBER '87 RAINBOW

THE CoCo CHECKBOOK -
\$25.00 + \$2.50 shipping and handling

PROGRAMS for PEOPLE
from
BOB'S SOFTWARE
P.O. Box 391 Cleveland, Ohio
44107-0391

Frank Hogg Laboratory

12 Years of Service, Support, and Friendly Help!

DISCOUNT NEW LOWER PRICES!! PRICE LIST

CoCo Burke & Burke Hard Drive Kits

FLASH! More Burke and Burke systems have been bought in the last six months than other systems have sold in the last 3 years!!!!

Our first system features the Burke & Burke XT or XT RTC interface. This interface uses popular and inexpensive IBM PC type controllers. For this reason it is the least expensive hard disk system available today. Not as fast as the Isted system but faster than any other system available. It also supports RLL drives. **Note:** Disk Extended Color Basic support and other software options are listed on our price list. **Disadvantage;** requires a multi-pak.

KIT INCLUDES: Burke & Burke (B&B) XT PC interface. Hard drive with controller, 3 foot ST506 cable set. Hard Drive Case with 60 watt power supply and fan. Includes OS9 LI and LII software. 1 megabyte transfer in 45 seconds! Type ahead under OS9. Complete instructions. Easy one evening assembly.

1 YEAR WARRANTY ON ALL SYSTEMS!

20 Meg Kit Complete 60MS	*498.00
30 Meg Kit Complete 60MS RLL	*548.00
40 Meg Kit Complete 60MS	*618.00
Assemble and test any of the above add	50.00

OPTIONS:

B&B Real Time Clock (add to above)	30.00
B&B XT ROM Auto Boot from hard disk	19.95
B&B Hyper I/O run DECB on hard drive	29.95
B&B Hyper III Ramdisk/spooler for above	19.95
FBU Fast Hard disk Back Up	75.00

Hard Drive Bits and Pieces

B&B XT PC style interface	69.95
B&B XT RTC interface w/clock/calendar (Call for Hard Drive and Kit prices)	99.95
FHL HCA/WD High Speed Interface	*99.95
WD 1002-05 High Speed for FHL Interface (Supports both Hard and Floppy drives) (Call for Hard Drive prices)	*196.00
Hard Drive case with 60W P/S and Fan	*98.00

(Can also be used for floppy drives)

SPECIFICATIONS: size 16" deep, 5.5" high, 7" wide. 60 Watt power supply with 3 drive type power connectors, quiet 12 volt DC fan, LED power indicator, color matches CoCo. Holds 2 1/2 height hard or floppy drives and has card guided space for a PCB the size of a drive (like the WD1002-05 controller)

Floppy Drives (5.25" and 3.5" FLOPPY DISKS)

TEAC High Quality Drives - 1 Year Warr.	
FD55B 360K 40 Track DS 5.25"	118.00
FD55F 720K 80 Track DS 5.25:	151.00
FD35F 720K 80 Track DS 3.5"	147.00
(Bare drives, requires case and power supply \$75.00)	

CoCo FHL High Speed Hard Drive Kits

Our top of the line system features Bruce Isted's interface for the Western Digital WD 1002-05 high speed controller. **Features;** fastest system available, 1 megabyte transfer in only 37 seconds!! Twice as fast as other systems! Supports 4 floppy and 3 hard drives, type ahead for both floppy and hard disk, **autoboot OS9 L1 or L2** from hard or floppy disk. **Disadvantage;** does not support DECB. This is *the* system of choice for the serious OS9 user.

KIT INCLUDES: FHL HCA/WD High Speed interface, Hard drive with WD 1002-05 controller, ST506 cable set, 4 foot 40 pin cable, Hard Drive Case with 60 watt power supply and fan, OS9 software for LI and LII with source, Complete instructions. Easy one evening assembly.
(**INTERFACE SPECIFICATIONS:** Size is the same as a floppy controller. Interfaces the WD 1002-05 controller to the CoCo. This controller handles 3 hard and 4 floppy drives. Type ahead under OS9 for both floppy and hard drive. Includes OS9 LI and LII software with source. Autoboot ROM included to boot from floppy or hard drive. Supports OS9 only. 1 megabyte transfer in 37 seconds!)

1 YEAR WARRANTY ON ALL SYSTEMS!

20 Meg High Speed Kit Complete	*725.00
40 Meg High Speed Kit Complete	*825.00
70 Meg High Speed Kit Complete	1260.00
Assemble & Test any of the above add	60.00

OPTIONS:

Floppy Drive (Mounted in case)	128.00
FBU Fast Hard disk Back Up	75.00

ORDERING INFORMATION VISA and M/C. NY residents add 7% sales tax. US shipping add \$3.50. Please call for Air Express shipping.

Send for **FREE FHL NewsLetter** and catalog.
**Most of our software requires OS9 LII and 512K.
* New **LOWER PRICES!!!**

Frank Hogg Laboratory, Inc.

770 James Street - Syracuse, NY 13203

Telex 646740

Call 315/474-7856

Frank Hogg Laboratory

12 Years of Service, Support, and Friendly Help!

OS9 Software

The WIZ

by Bill Brady

Did you ever wonder why there is only one really good communications package for OS9? The WIZ is so good that no one has been able to better it in over a year on the market! Simply the best package there is for OS9 and the CoCo III. **FEATURES:** Mac-Like interface with windows, text and binary upload/download with xmodem, kermit, on line HELP, AUTOLOGGING lets you dial up and log on to your favorite service, Macros, VT52 emulation, Usage log and much more.

The Wiz requires a RS232 Pak or similar device, LII and 512K. Supports the Owl-Ware Super I/O board.

The WIZ 79.95

Disto RS232 Pak 49.95

OS9 Users Group Disk Library

We have the complete OS9 Users Group Library available for immediate delivery. We pay the UG a royalty so you will be helping a worthy cause when you buy these disks. All the programs include source and some documentation. The 11 disk library is the best deal if you can read 80 track double sided disks. These disks are 720K each and are all almost full. That's almost 8 megabytes of programs for only \$156! The individual disks are on 35 or 40 track disks and some are double sided. Call or send for the list.

OS9 Users Group Disks each (50+ disks) 10.00
Complete 11 disk library 156.00

Inside OS9 Level II

The Book by Kevin Darling
\$39.95

Are you tired of playing games with Level II? Do you want to find out what's going on inside OS9? This is the book for you! Over 200 pages of hints, kinks, bugs, source listings and much more. Written by the well known Compuserve SysOp, Kevin Darling. 'Must reading' says Dale Puckett in Rainbow!

Sculptor

Sculptor is a applications language, commonly referred to as a 4th Generation Language. Basically this means that you can create applications in one tenth the time it would normally take. Sculptors screen and print formatting make screen displays and reports easy and fast. Sculptors B+ tree index system makes record lookup lighting fast. Programs are portable too.

Sculptor 249.00
Sculptor Special (If we have any left, (call)) 149.00

DynaStar

Used by more OS9 users than any other!

FEATURES: Best OS9 editor/word processor/text formatter, has everything you would expect and more, supports terminals and windows simultaneously, auto-configurable, auto-indent for C and Pascal programming, mail merge for form letters, bug free, solid. New manual makes it easier to use than ever. Most popular word processor since 1982! Uses CoCo 3's windows for pop-up help menus, can be disabled. Two key sequence to move from anywhere to anywhere in your text. WordStar command style. Will work with files larger than memory. Merge function allows stringing many files together at print time. Full block manipulation, mark, move, copy, delete, read from disk, write to disk. **Keyboard Macros:** Define or redefine any control key (up to 29) to reproduce any key sequences, including commands! Macros can be read in at startup automatically or created on the fly as needed. **Printer Control:** Supports multiple printers via a print control file that transforms imbedded control characters to printer control characters. Changing printers is easy. **Formatting Commands:** Justification, word wrap, centering, headers, footers, macros, odd and even support, multiple index generation, multiple table of contents generation and more! *DynaStar* is the last word processor you will ever have to buy! Level I version also included on disk.

DynaStar word processor/formatter 150.00

DynaSpell

by Dale Puckett

102,000 and 20,000 word dictionaries included. Supports both Level I and II. Fast, slick, the best available for OS9. Written by Rainbowtech columnist Dale Puckett.

DynaSpell spelling checker 75.00
SPECIAL WHEN PURCHASED WITH DYNASTAR 25.00

ORDERING INFORMATION VISA and M/C. NY residents add 7% sales tax. US shipping add \$3.50. Please call for Air Express shipping.

Send for FREE FHL NewsLetter and catalog.
**Most of our software requires OS9 LII and 512K.

Frank Hogg Laboratory, Inc.

770 James Street - Syracuse, NY 13203

Telex 646740

Call 315/474-7856

```

23 E1=E1+1:GOTO52
24 HPRINT(3,21),"YOU NEED A HEAD
":GOTO52
25 GOSUB127:GOTO52
26 HPRINT(10,4),"4=FEELERS
27 IFH1=0THEN33
28 IFF1=2THEN32
29 IFF1=0THEN H=95:GOSUB118
30 IFF1=1THEN H=102:GOSUB119:P1=
P1+2
31 F1=F1+1:GOTO52
32 GOSUB127:GOTO52
33 HPRINT(3,21),"YOU NEED A HEAD
":GOTO52
34 HPRINT(10,4),"5=TONGUE
35 IFH1=0THEN38
36 IFT1=1THEN39
37 IFT1=0THENX=100:H=106:GOSUB12
0:T1=1:P1=P1+1:GOTO52
38 HPRINT(3,21),"YOU NEED A HEAD
":GOTO52
39 GOSUB127:GOTO52
40 HPRINT(10,4),"6=LEGS
41 IFB1=0THEN51
42 IFL1=6THEN50
43 IFL1=0THEN H=85:GOSUB121
44 IFL1=1THEN H=62:GOSUB122
45 IFL1=2THEN H=42:GOSUB123
46 IFL1=3THEN H=38:GOSUB124
47 IFL1=4THEN H=55:GOSUB125
48 IFL1=5THEN H=77:GOSUB126:P1=P
1+6
49 L1=L1+1:GOTO52
50 GOSUB128:GOTO52
51 HPRINT(3,21),"YOU NEED A BODY
52 FORX=1TO1500:NEXTX:IFP1=13THE
N99ELSEGOSUB113:F=RND(6):HCOLOR3
:PLAY"O3T20B":HPRINT(21,1),N2$+"
,HIT A KEY":EXEC44539:HDRAW"BM19
0,27"+D$:Z=F:GOSUB106:PLAY"O4T60
CBDAEGFC
53 ON Z GOTO 54,58,64,72,80,86
54 HPRINT(30,4),"1=BODY
55 IFB2=1THEN57
56 IFB2=0THEN X=247:Y=93:H=220:G
OSUB114:B2=1:P2=P2+1:GOTO98
57 GOSUB129:GOTO98
58 HPRINT(30,4),"2=HEAD
59 IFH2=1THEN62
60 IFB2=0THEN63
61 IFH2=0THEN H=260:GOSUB115:H2=
1:P2=P2+1:GOTO98
62 GOSUB129:GOTO98
63 HPRINT(23,21),"YOU NEED A BOD
Y":GOTO98
64 HPRINT(30,4),"3=EYES
65 IFH2=0THEN70
66 IFE2=2THEN71
67 IFE2=0THEN H=273:GOSUB116
68 IFE2=1THEN H=258:GOSUB117:P2=
P2+2
69 E2=E2+1:GOTO98
70 HPRINT(23,21),"YOU NEED A HEA
D":GOTO98
71 GOSUB129:GOTO98
72 HPRINT(30,4),"4=FEELERS
73 IFH2=0THEN79
74 IFF2=2THEN78
75 IFF2=0THEN H=255:GOSUB118
76 IFF2=1THEN H=262:GOSUB119:P2=
P2+2
77 F2=F2+1:GOTO98
78 GOSUB129:GOTO98
79 HPRINT(23,21),"YOU NEED A HEA
D":GOTO98
80 HPRINT(30,4),"5=TONGUE
81 IFH2=0THEN84
82 IFT2=1THEN85
83 X=260:H=266:GOSUB120:T2=1:P2=
P2+1:GOTO98
84 HPRINT(23,21),"YOU NEED A HEA
D":GOTO98
85 GOSUB129:GOTO98
86 HPRINT(30,4),"6=LEGS
87 IFB2=0THEN97
88 IFL2=6THEN96
89 IFL2=0THEN H=245:GOSUB121
90 IFL2=1THEN H=222:GOSUB122
91 IFL2=2THEN H=202:GOSUB123
92 IFL2=3THEN H=198:GOSUB124
93 IFL2=4THEN H=215:GOSUB125
94 IFL2=5THEN H=237:GOSUB126:P2=
P2+6
95 L2=L2+1:GOTO98
96 GOSUB130:GOTO98
97 HPRINT(23,21),"YOU NEED A BOD
Y
98 GOTO6
99 GOSUB113:HPRINT(3,21),"THE WI
NNER!":PLAY"O1T60CDEFGABO2CDEFGA
BO3CDEFGABO4CDEFGABO5CDEFGAB":FO
RG=1TO2000:NEXTG:GOTO101
100 GOSUB113:HPRINT(23,21),"THE
WINNER!":PLAY"O1T60CDEFGABO2CDEF
GABO3CDEFGABO4CDEFGABO5CDEFGAB":
FORG=1TO2000:NEXTG:GOTO101
101 HCOLOR6:HLINE(110,75)-(210,1
20),PRESET,BF:HLINE(110,75)-(210
,120),PSET,B:HLINE(115,80)-(205,
115),PSET,B:HPRINT(112,77),6,6:H
PRINT(15,11),"PLAY AGAIN":HPRINT
(17,13),"(Y/N)?
102 I$=INKEY$:IFI$=""THEN102
103 IFI$="Y"THENRUN
104 IFI$="N"THEN131
105 GOTO102
106 IF Z=1THENHDRAW"BR7BD8"+DT$
107 IF Z=2THENHDRAW"BR2BD2"+DT$+
"BR10BD12"+DT$
108 IF Z=3THENHDRAW"BR2BD2"+DT$+
"BR5BD6"+DT$+"BR5BD6"+DT$
109 IF Z=4THENHDRAW"BR2BD2"+DT$+

```



```

"BR1ØBD12"+DT$+"BU12"+DT$+"BD12B
L1Ø"+DT$
11Ø IF Z=5THENHDRAW"BR2BD2"+DT$+
"BR1ØBD12"+DT$+"BU12"+DT$+"BD12B
L1Ø"+DT$+"BU6BR5"+DT$
111 IFZ=6THENHDRAW"BR2BD2"+DT$+"
BD6"+DT$+"BD6"+DT$+"BR1Ø"+DT$+"B
U6"+DT$+"BU6"+DT$
112 RETURN
113 HLINE(6,6)-(15Ø,48),PRESET,B
F:HLINE(166,6)-(31Ø,48),PRESET,B
F:HLINE(9,165)-(15Ø,175),PRESET,
BF:HLINE(169,165)-(31Ø,175),PRES
ET,BF:RETURN
114 HCOLOR1:HCIRCLE(H,1ØØ),35,,.
4,.11,.9:HDRAW"BM"+STR$(X)+", "+S
TR$(Y)+"D15":HPAINT(H,1ØØ),1,1:R
ETURN
115 HCOLORØ:HCIRCLE(H,1ØØ),13,,1
.7:HPAINT(H,1ØØ),Ø,Ø:RETURN
116 HCOLOR6:HCIRCLE(H,9Ø),5:HPAI
NT(H,9Ø),6,6:RETURN
117 HCOLOR6:HCIRCLE(H,91),5:HPAI
NT(H,91),6,6:RETURN
118 HCOLOR2:HDRAW"BM"+STR$(H)+",
8ØH1ØRF1ØRH1ØUHLGDFRULUR":RETURN
119 HCOLOR2:HDRAW"BM"+STR$(H)+",
8ØE1ØRGLØRE1ØHUERFDGLURUL":RETUR

```

```

N
12Ø HCOLOR5:HDRAW"BM"+STR$(X)+",
121D8RU8":HCIRCLE(H,13Ø),7:HPAIN
T(H,13Ø),5,5:RETURN
121 HCOLOR3:HDRAW"BM"+STR$(H)+",
11ØNFLF2D15LU15H2LF2D16R6DL6DR6"
:RETURN
122 HCOLOR3:HDRAW"BM"+STR$(H)+",
114ND13LD13LU13D14R6DL6DR6":RETU
RN
123 HCOLOR3:HDRAW"BM"+STR$(H)+",
112ND13LD13LU13D14R6DL6DR6":RETU
RN
124 HCOLOR3:HDRAW"BM"+STR$(H)+",
1Ø3"+LR$:RETURN
125 HCOLOR3:HDRAW"BM"+STR$(H)+",
1Ø5"+LR$:RETURN
126 HCOLOR3:HDRAW"BM"+STR$(H)+",
1Ø5"+LR$:RETURN
127 HPRINT(3,21),"ALREADY HAVE I
T":RETURN
128 HPRINT(3,21),"YOU HAVE ENOUG
H":RETURN
129 HPRINT(23,21),"ALREADY HAVE
IT":RETURN
13Ø HPRINT(23,21),"YOU HAVE ENOU
GH":RETURN
131 POKE65496,Ø:WIDTH32:CLS:END

```



HAWKSoft HAWKSoft HAWKSoft HAWKSoft HAWKSoft

DOMINATION.....\$18.00
MULTI-PLAYER STRATEGY GAME!



Try to take over the planet of YCNAN. Battle other players armies to take control of their provinces and defend yours. Play on a Hi-res map of the planet. Take the "RISK" and be a planet-lord today!!! Requires 1 disk and joystick or mouse. See Rainbow Review JULY 88

MYDOS.....\$15.00
CUSTOMIZABLE! EPROMABLE!!
The commands Tandy left out!

MYDOS is an enhancement to Disk Extended Basic 2.1 on the CoCo 3. One command loadm and execute for M/L programs. Lowercase command entry and display on ALL screens. Screen echo and SAY command for RS Speech Pak. Point and click mouse directory. NEW FEATURES!!!!

Supports double-sided and 40 track drives. Set any palettes you want on power-up (RGB or CMP). Power-up in any screen width and colors (or monochrome) you wish! More options than you can shake a joystick at!!! See Rainbow Review JUNE 87

HAWKSoft KEYBOARD CABLE.....\$25.00
UNCHAIN YOUR KEYBOARD!

Five foot extender cable for CoCo II and 3. Move your keyboard where you want it! Installation instructions and tips included! Custom lengths available.



HAWKSoft P.O. Box 7112
Elgin, IL 60121-7112
312-742-3084

S&H always included. Il. orders add 7% sales tax.

MLBASIC 2.0 - BASIC Compiler

If you want your BASIC programs to run up to 50 times faster, or want more programming features without learning another language, MLBASIC is for you. MLBASIC is the most compatible BASIC compiler available for the Color Computer. WHY? Because MLBASIC fully supports:

- Low- and high-resolution graphics
- All types of I/O (disk, screen, printer, RS232)
- All available commands offered with BASIC
- Floating point functions and expressions
- Integer, floating point and string type variables and arrays
- Use of all available 512K RAM in the COCO 3
 - 80,40 or 32 column text displays

MLBASIC not only contains everything that you would expect a BASIC programming language should contain, MLBASIC has features that offer flexibility of other languages like C, Pascal, FORTRAN and even assembly language. These features will allow programmers to directly access the CPU registers on the COCO, produce modular program code with SUBROUTINES, manipulate memory in blocks, and even call ROM routines in other areas of memory.

MLBASIC revision 2.0 has incorporated all enhancements that were suggested by MLBASIC 1.0 users and more. Revision 2.0 did away with all the incompatibility problems that existed with revision 1.0.

MLBASIC allows for the first time user to quickly compile a program using default compiler settings. The advanced user has the capability of controlling over a dozen settings which control where the program is compiled, which medium to compile to (memory or disk), string space, compiler listings and more.

With all this going for MLBASIC, your might expect the cost to be a little out of your budget. After looking at prices of other BASIC compilers for the COCO 3 you might be correct. But look again at this ad; for only \$59.95, you can have a programming language that will spark your interest once again in the COCO.

Before you buy another BASIC compiler for the COCO, find out if it supports everything MLBASIC supports. Then look at the price tag. We feel that it won't be long before you place an order for MLBASIC.

"MLBASIC is a fine program for any serious programmer,"
said David Gerald in the December 1987 RAINBOW.

<<<<< **ONLY \$59⁹⁵** >>>>>

COCO 3 WITH DISK REQUIRED - Add \$4.00 Postage.
Check, Money Order or COD accepted
Foreign orders use U.S. MONEY ORDERS only.

WASATCHWARE

7350 Nutree Drive
Salt Lake City, Utah 84121
Phone (801) 943-1546

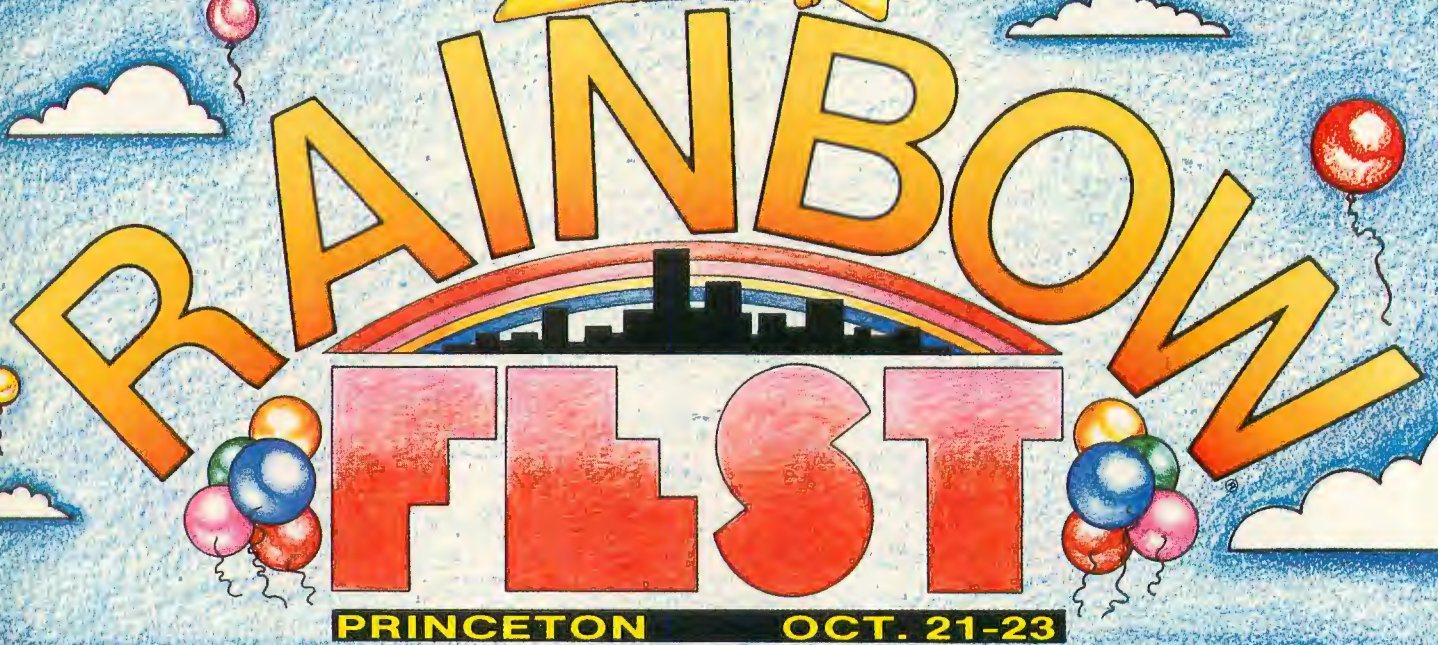

RAINBOW FEST

PRINCETON OCT. 21-23

RAINBOWfest is the only computer show dedicated exclusively to your Tandy Color Computer. Nowhere else will you see as many CoCo-related products or be able to attend free seminars conducted by the top Color Computer experts. It's like receiving the latest issue of THE RAINBOW in your mailbox!

RAINBOWfest is a **great opportunity** for commercial programmers **to show off new and innovative products for the first time**. Princeton is the show to get information on capabilities for the new CoCo 3, along with a terrific selection of the latest CoCo 3 software. In exhibit after exhibit, there will be demonstrations, opportunities to experiment with software and hardware, and special RAINBOWfest prices.

Set your own pace between visiting exhibits and attending the valuable, free seminars on all aspects of your CoCo — from improving BASIC skills to working with the sophisticated OS-9 operating system.

Many people who write for THE RAINBOW — as well as those who are written about — are there to meet you and answer questions. You'll also meet lots of other people who share your interest in the Color Computer. It's a person-to-person event and a tremendous learning experience in a fun and relaxed atmosphere.

A special feature of RAINBOWfest is the **Educational Sandbox**, which features **child-oriented workshops** to give hands-on experience to an age group often neglected. There are sessions for the kindergarten through third-graders, and for fourth- through sev-

enth-graders. And, as an additional treat for CoCo Kids of all ages, we've invited frisky feline CoCo Cat to join us for the show. RAINBOWfest has something for everyone in the family!

If you missed the fun at our last RAINBOWfest in Chicago, why don't you make plans now to join us in Princeton? For members of the family who don't share your affinity for CoCo, there are many other attractions in the Princeton area.

The Hyatt Regency Princeton offers special rates for RAINBOWfest. **The show opens Friday evening** with a session from 7 p.m. to 10 p.m. It's a daytime show Saturday — the CoCo Community Breakfast (separate tickets required) is at 8 a.m., then the exhibit hall opens promptly at 10 a.m. and runs until 6 p.m. On Sunday, the exhibit hall opens at 11 a.m. and closes at 3 p.m.

Tickets for RAINBOWfest may be obtained directly from the RAINBOW. We'll also send you a reservation form so you can get a special room rate.

The POSH way to go. You can have your travel arrangements and hotel reservations handled through RAINBOW affiliate, POSH Travel Assistance, Inc., of Louisville. For the same POSH treatment many of our exhibitors enjoy, call POSH at (502) 893-3311. All POSH services are available at no charge to RAINBOWfest attendees.

BE THERE!

SPECIAL EVENT!

COCO GALLERY LIVE SHOWCASE YOUR BEST AT RAINBOWFEST

We are taking the popular "CoCo Gallery" on the road to RAINBOWfest Princeton — and we'd like you to submit your own graphics creations to be exhibited at the show!

RULES

- You can enter color or black-and-white photographs or printouts of your original artwork produced on the CoCo 1, 2 or 3. Entries must be framed, mounted or matted, and may not be smaller than 5-by-7 inches or larger than 11-by-14 inches.
- Don't send us anything owned by someone else; this means no game screens, digitized images from TV programs or material that's already been submitted elsewhere. A digitized copy of a picture that appears in a book or magazine is **not** an original work.
- Along with your entry, send a cover letter with your name, address and phone number, detailing how you created your picture (what programs you used, etc.). Please include a few facts about yourself, too!
- Your name, address and phone number, along with the title of your work, must be clearly marked on the back of each entry, and a disk copy of each piece must also be included.
- Entries must be mailed to THE RAINBOW before October 10, 1988, or brought to the RAINBOWfest registration booth by 10 a.m., Saturday, October 22.
- All entries to CoCo Gallery Live become the property of Falsoft, Inc.

There will be two categories: one for graphics produced on the CoCo 1 and 2, and one for CoCo 3 graphics. Several awards will be made in each category. Winners will be determined by votes from RAINBOWfest attendees. In case of any ties, winners will be determined by our chief judge, CoCo Cat.

Prizes and ribbons will be presented Sunday, October 23, 1988, and winning entries will be published in the January '89 issue of THE RAINBOW. Send your entry to "CoCo Gallery Live," THE RAINBOW, 9509 U.S. Highway 42, Prospect, KY 40059.

YES, I'm coming to Princeton! I want to save by buying tickets now at the special advance sale price. Breakfast tickets require advance reservations.

Please send me:

___ Three-day ticket(s) at \$9 each	total _____	Name _____ (please print)
___ One-day ticket(s) at \$7 each	total _____	Address _____
Circle one: Friday Saturday Sunday		City _____ State _____
___ Saturday CoCo Breakfast at \$12 each	total _____	Telephone _____ ZIP _____
___ RAINBOWfest T-shirt(s) at \$6 each	total _____	Company _____
Specify size: ___ S ___ M ___ L ___ XL (T-shirts must be picked up at the door)		<input type="checkbox"/> Payment Enclosed, or Charge to: <input type="checkbox"/> VISA <input type="checkbox"/> MasterCard <input type="checkbox"/> American Express
Handling Charge \$1 _____		Account Number _____
TOTAL ENCLOSED _____		Exp. Date _____
(U.S. Currency Only, Please)		Signature _____

Also send me a hotel reservation card for the Hyatt Regency Princeton (\$88, single or double room).

Advance ticket deadline: October 7, 1988. Orders received less than two weeks prior to show opening will be held for you at the door. Tickets will also be available at the door at a slightly higher price. Tickets will be mailed six weeks prior to show. Children 4 and under, free; over 4, full price.

Make checks payable to: The RAINBOW. Mail to: RAINBOWfest, The Falsoft Building, 9509 U.S. Highway 42, P.O. Box 385, Prospect, KY 40059. To make reservations by phone, in Kentucky call (502) 228-4492, or outside Kentucky call (800) 847-0309.

Still pounding away at that keyboard?



Save Time and Money with a Combination Subscription!

SAVE up to 19%

when you buy a joint subscription to the magazine and either RAINBOW ON TAPE or RAINBOW ON DISK! A one-year subscription to THE RAINBOW and RAINBOW ON TAPE is only \$91 in the U.S., \$108 in Canada, \$153 foreign surface rate and \$188 foreign airmail. A one-year subscription to THE RAINBOW and RAINBOW ON DISK is only \$115 in the U.S., \$138 in Canada, \$183 foreign surface rate and \$218 foreign airmail.*

Every month, these convenient services bring you as many as 24 ready-to-run programs. Using the current issue of THE RAINBOW as documentation, all you have to do is load and run them. A one-year combination subscription to THE RAIN-

BOW and RAINBOW ON TAPE or RAINBOW ON DISK give you more than 230 new programs! The typing time you save can be spent enjoying your CoCo!

RAINBOW ON TAPE For No-Fuss Fun

Back issues of RAINBOW ON TAPE are available beginning with the April 1982 issue. A single copy of RAINBOW ON TAPE is \$10 within the United States; U.S. \$12 in all other countries. The annual subscription rate for RAINBOW ON TAPE is \$80 within the U.S.; U.S. \$90 in Canada; and U.S. \$105 for all other countries.*

RAINBOW ON DISK Offers OS-9 Programs

In addition to all the programs offered on tape, part of one side of RAINBOW ON DISK is formatted for the OS-9 operating system. That means you can now get all the OS-9 programs from the magazine — programs that cannot be put on tape. Back issues of RAINBOW ON DISK are available beginning with October 1986. Subscriptions to RAINBOW ON DISK are \$99 a year in the U.S. Canadian rate is U.S. \$115. All other countries, U.S. \$130. Single copy rate is \$12 in the U.S.; U.S. \$14 in Canada; and U.S. \$16 in all other countries.*

To order by phone (credit card orders only), call (800) 847-0309, 8 a.m. to 5 p.m. EST. All other inquiries call (502) 228-4492.

Look for our envelope located between pages 66 and 67 for ordering individual subscriptions to THE RAINBOW, RAINBOW ON TAPE and RAINBOW ON DISK.

YES! Sign me up for a joint 1-year subscription (12 issues) to:

- THE RAINBOW and RAINBOW ON TAPE
- THE RAINBOW and RAINBOW ON DISK
- NEW RENEWAL (attach labels)

Name _____

Address _____

City _____ State _____ ZIP _____

Payment Enclosed (*payment must accompany order)

Charge: VISA MasterCard Am. Express
Account Number _____

Signature _____ Exp. _____

*U.S. currency only, please. In order to hold down costs, we do not bill. Kentucky residents add 5% sales tax. Please allow 6 to 8 weeks for delivery of first copies. Joint subscriptions to THE RAINBOW and RAINBOW ON TAPE or RAINBOW ON DISK begin with the current issue.

Please note: While group purchases of RAINBOW ON TAPE and RAINBOW ON DISK are permitted (and multiple subscriptions are even discounted, if purchased in one order from a club), no license to make copies is conveyed or implied. Yes, your group may even purchase a subscription to our disk/tape services, but such purchase in no way authorizes that any copies be made of that original disk/tape. Specifically, this means that the original disk/tape itself may indeed be kept in a club library for use by members. However, a group purchase *does not* entitle club members, individually or as a group, to copy that disk/tape.

Unauthorized copying of any copyright product is strictly illegal. The copyright (right to make copies) is in no way conveyed in the purchase transaction.

```

1000 ' =====
1010 ' PRINT CHARACTERS
1020 ' =====
1030 POKE65495,0
1040 FOR I=1 TO LEN(T$)
1050 Z=ASC(MID$(T$,I,1))
1060 IFZ<32 THEN IF Z=13 THENPRI
NT#-2:PRINT#-2:GOTO1100
1070 Z=Z-31
1080 POKE65494,0
1090 PRINT#-2,A$(Z);
1100 NEXT
1110 PRINT#-2:PRINT#-2
1120 POKE65494,0
1130 RETURN
2000 ' =====
2010 ' LOAD STRING
2020 ' =====
2030 IF EOF(1) THENCLOSE:FLAG=1:
GOTO2080
2040 LINEINPUT#1,T$
2050 IFT$="" THEN2030
2060 PRINT@161,STRING$(254,32)
2070 PRINT@161,T$
2080 RETURN
3000 ' =====
3010 ' GET FILENAME
3020 ' =====
3030 PRINT@161,"ENTER FILENAME T
O BE PRINTED (MUST BE IN ASCI
I FORMAT): ";LINEINPUTF$
3040 IFF$="" THEN3030
3050 EXT=INSTR(F$,"/")
3060 IF EXT<>0 THEN IF LEN(F$)>1
2 THEN PRINT@289,"FILENAME TOO L
ONG":GOTO3030
3070 IF EXT=0 THEN IF LEN(F$)>8
THEN PRINT@289,"FILENAME TOO LON
G.":GOTO3030
3075 PRINT@289,STRING$(32," ")
3080 OPEN"I",1,F$
3090 RETURN
4000 ' =====
4010 ' READ CHAR. DATA
4020 ' =====
4030 PRINT@161," WORKING, PLEASE
WAIT...":PRINTSTRING$(32," ")
4040 POKE65495,0
4050 FORX=1 TO 91
4060 READA:IF A=999 THEN4090
4070 A$(X)=A$(X)+CHR$(A)
4080 GOTO4060
4090 NEXT
4100 POKE65494,0
4110 RETURN
5000 ' =====
5010 ' PRINT TITLE
5020 ' =====
5030 CLS:PRINTSTRING$(32,175);
5040 PRINTTAB(10)"ITALICS-105"
5050 PRINTTAB(7)"BY DAVID FRANCI

```

```

S"
5060 PRINTSTRING$(32,175)
5070 RETURN
6000 ' =====
6010 ' PRINTER ONLINE?
6020 ' =====
6030 IFPEEK(65314)<>5 THEN6080
6040 PRINT@161,"PRINTER IS NOT R
EADY. PRESS ANY KEY WHEN PRI
NTER IS READY."
6050 I$=INKEY$:IFI$=""THEN6050
6060 GOTO6030
6070 PRINT@161,STRING$(254," ");
6080 RETURN
7000 ' =====
7010 ' SETUP
7020 ' =====
7030 DIMA$(100)
7040 FLAG=0
7050 POKE150,18
7060 PRINT#-2,CHR$(27);CHR$(20);
CHR$(18);CHR$(27);CHR$(16);CHR$(
0);CHR$(0);
7070 RETURN
10000 ' =====
10010 ' CHARACTER DATA
10020 ' =====
10030 DATA 128,128,128,128,128,1
28,128,999
10040 DATA 128,128,192,128,144,1
36,132,130,129,999
10050 DATA 128,128,132,130,129,1
32,130,129,999
10060 DATA 128,128,192,176,144,2
20,180,150,157,132,134,129,999
10070 DATA 128,128,160,224,164,1
86,170,174,154,131,130,128,128,9
99
10080 DATA 128,128,194,163,145,1
37,197,227,161,128,128,999
10090 DATA 128,128,224,208,206,2
17,163,208,128,128,999
10100 DATA 128,128,132,130,129,9
99
10110 DATA 128,128,176,200,132,1
30,129,129,999
10120 DATA 128,128,192,192,160,1
44,137,135,128,999
10130 DATA 128,128,132,148,143,1
58,133,132,999
10140 DATA 128,128,168,152,136,1
40,138,999
10150 DATA 128,128,192,176,144,1
28,128,128,999
10160 DATA 128,128,136,136,136,1
36,136,999
10170 DATA 128,128,192,224,160,1
28,128,999
10180 DATA 128,128,192,190,129,9
99
10190 DATA 224,208,216,212,202,1

```

69,149,141,133,131,999
 10200 DATA 192,192,224,144,138,1
 33,131,129,999
 10210 DATA 192,224,208,200,202,2
 01,137,133,131,999
 10220 DATA 224,192,194,201,201,1
 69,153,133,131,999
 10230 DATA 152,212,178,146,154,1
 33,131,129,128,999
 10240 DATA 224,192,196,198,197,1
 65,149,141,129,128,999
 10250 DATA 224,208,200,204,202,1
 69,153,129,128,999
 10260 DATA 192,161,145,137,133,1
 31,128,999
 10270 DATA 224,208,204,202,201,1
 69,153,133,131,128,999
 10280 DATA 192,192,204,202,169,1
 53,137,133,131,128,999
 10290 DATA 128,128,160,176,148,1
 34,130,128,999
 10300 DATA 128,128,192,192,176,1
 48,134,130,128,999
 10310 DATA 128,128,152,164,194,1
 29,128,999
 10320 DATA 128,128,144,148,148,1
 48,148,132,999
 10330 DATA 128,128,192,161,146,1
 40,128,999

10340 DATA 128,128,192,130,145,1
 37,133,131,128,999
 10350 DATA 128,128,224,208,202,2
 33,217,169,145,142,999
 10370 DATA 192,160,144,152,148,1
 46,255,128,128,999
 10380 DATA 192,192,224,208,200,2
 05,203,169,153,133,130,999
 10390 DATA 224,208,200,196,194,1
 93,161,129,131,999
 10400 DATA 192,192,224,208,200,1
 96,195,161,145,137,133,130,999
 10410 DATA 192,224,208,200,204,2
 02,201,129,129,129,129,999
 10420 DATA 192,160,144,136,140,1
 38,137,129,129,129,129,999
 10430 DATA 224,208,200,196,194,2
 09,177,145,131,999
 10440 DATA 192,160,144,136,140,2
 02,169,152,136,132,130,129,999
 10450 DATA 192,192,224,144,136,1
 32,131,129,129,999
 10460 DATA 224,208,192,192,192,1
 60,144,136,132,130,129,999
 10470 DATA 192,160,144,136,140,1
 54,169,200,132,130,129,999
 10480 DATA 192,224,208,200,196,1
 94,129,128,999
 10490 DATA 192,160,144,136,132,1

New, Lowest Prices Ever On Interfaces

Model 101 Serial to Parallel Printer Interface

- ★ Works with any COCO
- ★ Compatible with "Centronics" Parallel Input Printers
- ★ Just turn the knob to select any one of 6 baud rates 300-9600
- ★ Comes complete with cables to connect to your printer and computer
- ★ Can be powered by most printers

Model 104 Deluxe Interface with "Modem Switch"

- ★ Same Features as 101 Plus
- ★ Built in Serial Port for your Modem or other serial device
- ★ Switch between Serial Output and Parallel Output
- ★ Comes with cables to connect to your computer and printer
- ★ Can be powered by most printers

Model 105 Serial Switch

- ★ Connects to your COCO to give you 2 switch selectable Serial Ports
- ★ Comes with a 3 foot cable to connect to your computer
- ★ Now you can connect your Printer (or printer interface) and your Modem (or other serial device) to your COCO and flip the switch to use either device
- ★ Does not require power

Cassette Label Printing Program

- ★ New Version 2.1 prints 7 lines of information on Cassette labels
- ★ Comes on Tape with instructions to transfer to disk
- ★ Menu driven, very easy to use
- ★ Save and Load Labels from Tape and Disk
- ★ Uses the features of your printer to print standard, expanded, and condensed characters
- ★ Automatically Centers Each Line of Text
- ★ Allows editing of label before printing
- ★ Program comes with 24 labels to get you started
- ★ 16K ECB required

Some of the Printers

That Can -
 Supply power for the 101 and 104 are Radio Shack, Star, Okidata, Brother, Juki, and Smith Corona.

Some of the Printers

That Cannot -
 Supply power for the interfaces are Epson, Seikosha, Panasonic, Silver Reed and NEC. If your printer cannot supply power to the interface you can order your interface with the "P" option or you can supply your own AC adapter. We recommend the Radio Shack 273-1431 AC adapter with a 274-328 connector adapter.

Write or call for more information or for technical assistance.

Price List

Model 101	35.95
Model 101P	41.95
Model 104	44.95
Model 104P	51.95
Model 105	14.95
Cassette Label Program	6.95
Pin Feed Cassette Labels:	
White	3.00/100
Colors (specify)	3.60/C
Red-Blue-Yellow-Tan	
C-10 Cassette	
Tapes	7.50/dozen
Cassette Storage	
Boxes	2.50/dozen
4 Pin Din Serial	
COCO Cables:	
Male/Male 6 foot	4.49
Male/Female 6 foot	4.49
Female/Female 6 foot	4.49
Other Lengths Available.	

All items covered by a 1 year warranty

Ordering Info

- ★ **Free Shipping** in the U.S.A. and Canada (except AK and HI) on all orders over \$50
- ★ On orders under \$50 please add \$2.50 for shipping and handling
- ★ On orders outside the U.S.A. and Canada please write or call for shipping charges

You Can Pay By:

- ★ VISA or MasterCard
- ★ C.O.D. - add \$2.25
- ★ Or send check or money order payable in U.S. funds

Metric Industries Inc.
Cincinnati, OH 45242
P.O. Box 42396
(513) 677-0796

30, 193, 162, 148, 138, 133, 131, 129, 99
 10500 DATA 192, 160, 144, 136, 132, 1
 30, 255, 144, 136, 132, 130, 129, 999
 10510 DATA 224, 208, 200, 196, 194, 1
 61, 145, 137, 133, 130, 999
 10520 DATA 192, 160, 144, 136, 140, 1
 38, 137, 137, 137, 137, 133, 130, 999
 10530 DATA 224, 208, 200, 196, 210, 1
 61, 209, 137, 133, 131, 999
 10540 DATA 192, 160, 144, 136, 140, 1
 38, 153, 169, 201, 137, 133, 130, 999
 10550 DATA 192, 192, 196, 202, 201, 2
 01, 169, 145, 129, 999
 10560 DATA 192, 160, 144, 137, 133, 1
 31, 129, 129, 129, 999
 10570 DATA 224, 208, 200, 196, 194, 1
 61, 144, 136, 132, 130, 129, 999
 10580 DATA 128, 128, 255, 144, 136, 1
 32, 130, 129, 999
 10590 DATA 224, 208, 200, 164, 210, 2
 01, 160, 144, 136, 132, 130, 129, 999
 10600 DATA 192, 160, 144, 255, 132, 1
 30, 129, 999
 10610 DATA 192, 160, 159, 136, 132, 1
 30, 129, 999
 10620 DATA 192, 224, 209, 201, 197, 1
 31, 129, 999
 10630 DATA 192, 224, 208, 136, 132, 1
 30, 129, 129, 999
 10640 DATA 128, 129, 190, 192, 128, 9
 99
 10650 DATA 192, 192, 192, 160, 144, 1
 36, 133, 131, 129, 999
 10660 DATA 136, 132, 130, 143, 999
 10680 DATA 128, 128, 135, 136, 999
 10690 DATA 128, 999
 10700 DATA 224, 208, 212, 212, 244, 2
 12, 136, 999
 10710 DATA 192, 224, 208, 200, 196, 1
 98, 165, 148, 136, 999
 10720 DATA 224, 208, 200, 196, 196, 1
 32, 132, 999
 10730 DATA 224, 208, 200, 196, 196, 1
 64, 148, 140, 132, 130, 129, 999
 10740 DATA 224, 208, 216, 212, 212, 1

48, 148, 136, 999
 10750 DATA 192, 160, 152, 136, 140, 1
 38, 129, 129, 130, 999
 10760 DATA 192, 192, 216, 212, 180, 1
 48, 140, 132, 999
 10770 DATA 192, 160, 144, 136, 132, 1
 98, 165, 148, 136, 999
 10780 DATA 192, 160, 144, 136, 132, 1
 28, 129, 999
 10790 DATA 224, 192, 192, 160, 144, 1
 36, 132, 128, 129, 999
 10800 DATA 192, 160, 144, 136, 156, 1
 70, 201, 136, 999
 10810 DATA 192, 192, 224, 144, 136, 1
 32, 131, 129, 999
 10820 DATA 192, 160, 144, 140, 164, 1
 48, 200, 164, 152, 999
 10830 DATA 192, 160, 144, 140, 196, 1
 64, 148, 136, 999
 10840 DATA 224, 208, 200, 196, 196, 1
 64, 148, 140, 999
 10850 DATA 192, 160, 144, 152, 148, 1
 48, 148, 136, 128, 999
 10860 DATA 128, 152, 212, 180, 148, 1
 40, 132, 999
 10870 DATA 192, 160, 144, 136, 132, 1
 32, 132, 136, 999
 10880 DATA 192, 192, 216, 212, 212, 1
 64, 132, 999
 10890 DATA 224, 208, 204, 132, 134, 1
 32, 999
 10900 DATA 224, 208, 200, 196, 224, 2
 08, 136, 132, 999
 10910 DATA 128, 252, 160, 144, 136, 1
 32, 999
 10920 DATA 224, 208, 200, 164, 208, 1
 92, 160, 144, 136, 132, 999
 10930 DATA 192, 160, 144, 252, 136, 1
 32, 999
 10940 DATA 192, 216, 212, 176, 144, 1
 36, 132, 999
 10950 DATA 192, 228, 212, 204, 132, 9
 99

Dr. Nibble

By Kelly Taylor





Making the **MicroWorld** of
CoCo's AFFORDABLE....

CoCo III Drive 0 (NEW)	Special \$139 \$235
CM-8 Monitor Deluxe Joystick	Special \$239 \$ 24
Mouse Joysticks (pair)	\$40 \$13
Disk storage box (50) CCR-81 Cass. Rec.	\$12.50 \$42

Disks (SS)	\$7.00/box
Disks (DS)	\$7.50/box
*Includes free library case	
DMP-106	\$159
DMP-130A (120 CPS)	\$265
DMP-440	\$545
Tandy 1000 HX	\$555
Tandy 1000 TX	\$899
VM-4 Monitor	\$ 99
CM-5 Monitor	\$240
CM-11 Monitor	\$325

CoCo 3 512K Upgrade	\$135
MultiPak Upgrade (26-3024)	\$ 12
MultiPak Upgrade (26-3124)	\$ 12
OS-9 Level 2	\$ 63.95

Minimum Order \$15.00

* Please Note - Our ads are submitted early, so prices are subject to change!!! We appreciate your cooperation & understanding in this matter

Method of Payment:
MC, Visa, Am.Ex. - Sorry, No Citiline!
Certified Check or Money Order.
Personal Checks - Allow 1 week to clear!

FREE PRICE LIST AVAILABLE

**20 % OFF ALL TANDY SOFTWARE
MIN. 15% OFF ALL TANDY HARDWARE**

* Full TANDY Warranty ==> CALL <==
In Pa: 215 863-8911
* 100% TANDY PRODUCTS In N.J.: 201 735-6138
* FREE UPS Shipping †on orders over \$50.00 under \$50 add \$2.00



COMPUTER CENTER

MicroWorld

Rts 33 & 512, Wind Gap, PA 18091

Laneco Plaza, Clinton, N.J. 08809

C.O.D. ADD \$5.00

ALL PRICES INCLUDE SHIPPING †!!!
(In Continental US)

**100% TANDY EQUIPMENT WITH FULL
RADIO SHACK WARRANTY**

Just when you thought it was safe to go back into the tombs . . .

Escape From Tut's Tomb, Parts 2 and 3

By Chris McKernan

Talk about cliffhangers, gentle reader. Last month we left you busily keying in the first part of *Tut's Tomb*. No doubt you took a tumble into the passages and found yourself menaced by scorpion-tailed bats, disembodied dragon heads and other uglies. You might have discovered that it's hard to stay alive to the end of a five-level maze when you have only three lives. Those are the breaks, Adventurer.

But if you're one of the quick-on-your-feet elite, you might have made it past the curses, the vile creatures whose job it is to prevent you from completing the fifth and final maze of Part 1 and receiving your hint. (*What hint? We're not telling.*)

In fact, if you made it through Part 1 of *Tut's Tomb*, you can classify yourself as an arcade addict. And from there it's a safe assumption that right now you are experiencing withdrawal symptoms induced by the *Tut's Tomb* cliffhanger. (You'll recognize this condition by observing the behavior of your fingers, which will restlessly seek to manipulate a joystick that isn't there.)

Here at THE RAINBOW, we take everyone's welfare to heart — even you arcade junkies and video Adventurers. And so, without further ado, we bring you parts 2 and 3 of *Tut's Tomb*, which add up to 10 more mazes of thrills-and-chills excitement!

Part 2

Flex your fingers and follow these steps to key in Part 2 of *Tut's Tomb*:

- 1) Type in and save the listings 2PART1 and 2PART2
- 2) Reset the computer with a cold start (enter PDKE 113,0 and press the reset button) and load TUT1 from last month by entering (C) LOADM "TUT1",16384

Chris McKernan is an electronics technician for Paramax Electronics. His hobbies include computers, photography and music.





- 3) RUN "2PART1"
- 4) RUN "2PART2"
- 5) (C)SAVEM "TUT2",20479,
26405,26405
- 6) (C)LOADM "TUT2",49152
- 7) (C)SAVEM "TUT2",4095,
10021,10011

When run, the two BASIC listings build a machine language file, TUT2. Steps 6 and 7 change the loading addresses.

Part 3

To generate Part 3 of *Tut's Tomb*, TUT3, do the following:

- 1) Type in and save the listings 3PART1 and 3PART2
- 2) Reset the computer with a cold start (enter POKE 113,0 and press the reset button) and load TUT1 from last month by entering (C)LOADM "TUT1",16384)
- 3) RUN "3PART1"
- 4) RUN "3PART2"
- 5) (C)SAVEM "TUT3",20479,
26405,26405
- 6) (C)LOADM "TUT3",49152
- 7) (C)SAVEM "TUT3",4095,
10021,10011

You have now created the third and final machine language file, TUT3.

Wrapping It Up

After all this work, your *Tut's Tomb* program should consist of the following files:

```
ONE.BAS
TWO.BAS
THREE.BAS
FOUR.BAS
TUT1.BIN
2PART1.BAS
2PART2.BAS
TUT2.BIN
3PART1.BAS
3PART2.BAS
TUT3.BIN
```

All you have to do to execute the game is enter (C)LOADM "TUT1" and EXEC.

Mummy's the Word

For the benefit of those who were not with us last month, *Tut's Tomb* is an arcade game in which as an Adventurer you have discovered the priceless tomb of King Tut — but at perhaps the cost of your life (of which you have three, by the way).

Five obstacles stand in your way to riches, fame and glory, and rather

ghastly obstacles at that: scorpion-tailed bats, blue serpents, giant spiders, disembodied dragon heads and curses. For your defense against these creatures, you carry a musket, which you can fire only to the left and right; you need a joystick plugged into the right joystick port. Creatures are killed by being shot in the upper part of their bodies. But you can't get rid of them for long, however: Every time a creature is killed near its lair, a new one materializes to take its place.

In each maze level, the goal is to grab all the goodies you can (not forgetting the key) and sneak past the monsters into the next level.

Programming buffs might want to examine Table 1 for a listing of the routines used and their locations.

Psst! If you find you're losing all your lives before you can complete even the first or second maze, you might want to check out the program *Immortality Finder* in *Novices Niche*, Page 76.

(Questions or comments regarding this program may be directed to the author at 2369 Madison #9, Montreal, Quebec, Canada H4B 2T5. Please enclose an SASE when requesting a reply.) □

Table 1: Routines Listing

LOCATION	NAME OF ROUTINE	LOCATION	NAME OF ROUTINE
5939 (BASE 10)	Sound Routine	7278	Initialize Creatures
6000	PMODE	7397	Check Left
6023	PCLS	7412	Check Right — for Creatures
6036	Character print X=LOC A=CHAR	7427	Check Up
6062	SCORE (Prints Score)	7442	Check Down
6108	"HIGH:"	7459	Dir 5 (exit Lair)
6149	Highscore print	7533	Pick Direction
6195	LVL:0 (not used)	7642	Move Left
6237	SHIPS:0 (not used)	7667	Move Right
6256	Print Maze	7692	Move Down
6403	Maze Data	7718	Move Up
6511	Check Up	7744	Move 2
6541	Check Down — for explorer	7804	Creature Main Movement
6562	Check Left — for explorer	7894	— STOP —
6581	Check Right	9307	Move Change
6600	Print Man	9451	Change 2
6628	Erase Man	9548	Take Prize
6647	Move Up	9601	Print Key
6670	Move Down — for explorer	9636	Take Key
6693	Move Left — for explorer	9678	Next Maze??
6715	Move Right	9742	Check for kill
6738	Laser Right	9810	Implement Check
6789	Laser Left	9853	DIR 5 SOUND
6846	Move or Fire (Main Routine)	9909	Clear screen, print key, treasure & CAM
6926	Print Key & Treasure	10006	— STOP —
6978	New Game Resets Variables	10011	Relocate Stacks & Start Game
7002	Clear Creatures Resets Positions	5130	Print "GAME OVER"
7024	Print Smoke X=LOC	5200	Dead Sound
7049	Blank Print X=LOC	5300	Laser Sound
7066	Points (creature)	5400	Delay Creature dead (smoke)
7104	Check Hit	5550	Sound Key
7247	Print Creature	5600	Sound Treasure

Editor's Note: For your convenience, last month's machine language file, TUT1, is included on this month's RAINBOW ON TAPE and DISK, along with this month's four BASIC programs and the two ML files for parts 2 and 3 of Tut's Tomb: TUT2.BIN and TUT2.BIN. RAINBOW ON TAPE and DISK users will only need to load Part 1, TUT1, and type EXEC. The files have already been moved to their proper memory locations.

✓	140108	126071
	290236	1400248
	520228	160072
	68027	175041
	900138	END91
	1050242		

Listing 1: 2PART1

```

5 CLEAR 100, &H4FFE
10 REM #####
    ## RUN after LOADING ##
    ## TUT1 SEE TEXT ##
    #####
15 FOR X=20479 TO 21959:READ DT:
POKE X,DT:NEXT X
20 DATA 189,18,119,189,23,112,18
9,23
30 DATA 135,189,38,229,189,23,17
4,189
40 DATA 23,220,189,24,5,189,24,9
3
50 DATA 127,30,250,134,1,183,31,
54
60 DATA 183,31,55,134,240,183,31
,24
70 DATA 189,25,3,189,24,112,189,
25
80 DATA 200,189,27,14,189,27,90,
189
90 DATA 18,92,182,255,0,129,254,
39
100 DATA 4,129,126,38,245,189,37
,76
110 DATA 189,37,164,189,38,82,18
9,38
120 DATA 125,79,177,30,237,38,19
,189
130 DATA 20,10,182,255,0,129,254
,16
140 DATA 39,255,157,129,126,38,2
43,126
150 DATA 15,255,189,26,190,189,3
7,206
160 DATA 189,28,110,189,29,35,18
9,16
170 DATA 162,189,16,152,189,30,1
24,189
180 DATA 25,200,189,23,174,189,3
6,235

```

```

190 DATA 16,142,0,0,49,33,16,140
200 DATA 9,196,39,2,32,246,126,1
6
210 DATA 68,79,189,25,228,57,128
,184
220 DATA 255,15,57,182,39,116,12
9,180
230 DATA 36,7,139,60,183,39,116,
32
240 DATA 3,127,39,116,189,29,109
,57
250 DATA 57,255,255,255,255,255,
255,255
260 DATA 255,0,0,0,0,0,0,0
270 DATA 0,0,0,0,0,134,128,184
280 DATA 255,15,182,255,15,183,4
,0
290 DATA 32,243,0,0,0,0,0,0
300 DATA 0,0,0,0,4,0,0,0
310 DATA 0,0,0,0,0,0,0,0
320 DATA 4,0,0,0,0,0,0,0
330 DATA 0,0,0,0,0,0,0,0
340 DATA 83,251,255,255,255,255,
255,255
350 DATA 255,255,255,255,255,255
,255,255
360 DATA 255,255,255,255,255,255
,255,255
370 DATA 255,255,255,255,255,255
,255,255
380 DATA 255,255,255,255,255,255
,255,255
390 DATA 255,255,255,255,255,255
,255,255
400 DATA 255,255,255,255,255,255
,255,255
410 DATA 255,255,255,255,255,255
,255,255
420 DATA 255,0,0,0,0,0,0,0
430 DATA 0,0,0,0,0,0,0,0
440 DATA 0,0,0,0,0,0,0,0
450 DATA 0,0,0,0,0,0,0,0
460 DATA 0,0,0,0,0,0,0,0
470 DATA 0,0,0,0,0,0,0,0
480 DATA 0,0,0,0,0,0,0,0
490 DATA 0,0,0,0,0,0,0,0
500 DATA 35,255,255,255,255,255,
255,255
510 DATA 255,255,255,255,255,255
,255,255
520 DATA 255,255,255,255,255,189
,21,224
530 DATA 189,21,224,189,21,224,1
27,255
540 DATA 201,127,255,34,127,255,
202,127
550 DATA 255,206,127,255,192,127
,255,194
560 DATA 127,255,196,142,17,248,
16,142
570 DATA 4,0,95,166,128,167,160,

```



◀◀ GIMMESOFT ▶▶



A new generation of Color Computer products

V-Term Terminal Emulator (128k or 512k CoCo III only) ◀◀ IMPROVED!

V-Term is one of the most advanced terminal programs for the CoCo III ever!!!
FEATURES: VT-100, VT-52, Vidtex (includes RLE graphics display), and standard CRT emulations. Full use of 512K, 80X28 text or graphics characters. Windows & Multi-tasking (Disk Basic!), RAMDISK like buffer, Xmodem, Xmodem-CRC, Ymodem, Xon/Xoff, Monochrome monitor support, Capture buffer, Snapshot, Conference mode, Serial/RS-232/DCModem Pak, 35/40/80 Tracks, Over 56 pages of docs! Disk \$39.95 Ver 02.00.00 upgrade \$6.95

CoCo Max III (CoCo III only) See April '88 review. Built in Animation! / Amazing Color Sequencing!!! Comes with HI-RES INTERFACE, MINILOAD/BAS, DEMO DISK, COCO SHOW PGM. Sale \$74.95

MAXSOUND (128k or 512k CoCo III only) See June '88 review

Turn your CoCo III into a REAL digital audio sampler with HIGH quality audio reproduction. Easily add exotic effects, ECHO, stuttering, speed shifting, sequencing, and reverse audio to BASIC or ML programs or GRAPHICS! Now includes Data Compression. Imagine recording any Voice, Music, or Sound effect and being able to use these DIGITAL recordings in your own programs! 3 disk sides includes: INTERFACT/BIN - ML driver for sound effects. G&M/BAS - Adds sound effects to Graphics. SHOWTIME and DEMO disks. SCOPE/BAS - Turns CRT into a Digital Oscilloscope to look at MAXSOUND waveforms. CALL TO HEAR 'OVER THE PHONE' DEMO \$59.95

MAXSOUND SOUNDTRACKS W/GRAPHICS (MAXSOUND program NOT req'd) Call for Titles \$5.95

GRAPHICS-25 (512k CoCo III only) Goes great with MAXSOUND!

Utilize the FULL 512k memory range of your CoCo III from BASIC for graphics! Create up to 25 ONBOARD HIRES SCREENS! Six new BASIC commands allow instant display switching while secretly drawing other screens. Save and load screens to and from disk. Copy one screen to another. Fast Graphics action, Smooth animation, and 100% Machine Language code. Requires DECB 1.0, DECB 1.1, or FKEYS III. Complete with documentation. Disk .. \$24.95

MULTI-LABEL III (CoCo III only) See July '87 review. An easy to use, versatile label creating program including many new CoCo III features. Print multiple fonts on each label! Disk \$16.95

FKEYS III (CoCo I/II/III) See April '87 review. A user friendly, user programmable function key utility that creates up to 20 function keys. Includes an EDITOR, DOS mods, DISABLE, and it's EPROMable! Disk \$19.95

SIXDRIVE (CoCo I/II/III) This machine language utility modifies DECB 1.0, 1.1, FKEYS III, or ADOS to allow the use of 3 double-sided drives (or 2 D/S drives and J&R's RAMDISKS) as 6 S/S drives. Disk .. \$16.95

AUTO DIM (CoCo III only) See Jan. '88 review. This hardware device protects your monitor, or TV from IMAGE BURN after a few minutes of inactivity from your keyboard. Illustrated and easy to install. Hdwe \$29.95

MPI-CoCo Locking Plate (CoCo III only) Now 2 styles Protects your CoCo III and Multi Pak Interface from destroying each other! Please specify MPI number 26-3024 or 26-3124 when ordering! Only \$9.95

In Quest of the Star Lord (CoCo III only) Enjoy the mixture of science and fantasy as you quest for the Phoenix Crossbow, the only thing that can save you in the post-holocaust world. 4 Disk sides of animated graphics adventure! Outstanding 320x200 graphics! Disk \$34.95 Hint Sheet \$3.95

Kung-Fu Dude (CoCo I/II/III) See Feb. '88 review. A Kung-Fu program for the CoCo. Destroy opponents and evade obstacles as you grow even closer to your ultimate objective! Disk \$24.95

PYRAMIX (CoCo III only) See Dec. '87 review. Brilliant colors, sharp graphics, and hot action! Disk .. \$19.95

AD&D Character's Companion (CoCo I/II/III) Great timesaving utility helps create a compatible AD&D character. Includes a dice rolling routine, pick ability, race and class. Buy anything from the Players Handbook, magic items and spell materials. Save, load and print character info. 3 Disk sides \$24.95

White Fire of Eternity (CoCo I/II/III) See Dec. '86 review. A great graphics adventure! Disk.. \$19.95

CHAMPION (CoCo I/II/III) See May '87 review. Become a superhero in this action adventure! Disk.. \$19.95

Toll Free

1-800-441-GIME

Order Line

Technical assistance: 7pm to 9pm
Orders: 9am to 9pm Eastern time
On-line orders and up to date
information: Delphi's CoCo Sig

GIMMESOFT
P.O. Box 421
Perry Hall, MD 21128
301-256-7558 or 301-256-2953

Add \$3.00 for shipping and handling
Add \$2.50 for COD (USA only)
MD residents add 5% sales tax
VISA/MC/Check/Money Order/COD

92
 58Ø DATA 193,78,39,2,32,245,182,
 3Ø
 59Ø DATA 22Ø,183,15,161,182,3Ø,2
 21,183
 6ØØ DATA 15,162,182,3Ø,222,183,1
 5,163
 61Ø DATA 182,3Ø,223,183,15,164,1
 82,3Ø
 62Ø DATA 224,183,15,165,134,1ØØ,
 183,15
 63Ø DATA 16Ø,57,4,4,4,4,4,4
 64Ø DATA 4,Ø,Ø,Ø,Ø,Ø,Ø,Ø
 65Ø DATA Ø,3,12,21,5,32,4,5
 66Ø DATA 5,16,5,18,32,1,14,4
 67Ø DATA 32,4,5,5,16,5,18,32
 68Ø DATA 32,32,32,32,32,32,32,32
 5,255,255
 1Ø6Ø DATA 255,Ø,Ø,Ø,Ø,Ø,Ø,Ø
 1Ø7Ø DATA Ø,Ø,Ø,Ø,Ø,Ø,Ø,Ø
 1Ø8Ø DATA Ø,Ø,Ø,Ø,Ø,Ø,Ø,Ø
 1Ø9Ø DATA Ø,Ø,Ø,Ø,Ø,Ø,Ø,Ø
 11ØØ DATA Ø,Ø,Ø,Ø,Ø,Ø,Ø,Ø
 111Ø DATA Ø,Ø,Ø,Ø,Ø,Ø,Ø,Ø
 112Ø DATA Ø,Ø,Ø,Ø,Ø,Ø,Ø,Ø
 113Ø DATA Ø,Ø,Ø,Ø,Ø,Ø,Ø,Ø
 114Ø DATA 193,255,255,255,255,25
 5,74,32
 115Ø DATA 32,255,255,255,255,255
 ,255,255
 116Ø DATA 255,255,255,255,255,25
 5,255,255
 117Ø DATA 255,255,255,255,255,25
 5,255,255
 118Ø DATA 255,255,255,255,255,25
 5,255,255
 119Ø DATA 255,255,255,255,255,25
 5,255,255
 12ØØ DATA 255,255,255,255,255,25
 5,255,255
 121Ø DATA 255,255,255,255,255,25
 5,255,255
 122Ø DATA 255,Ø,Ø,Ø,Ø,Ø,Ø,Ø
 123Ø DATA Ø,Ø,Ø,Ø,Ø,Ø,28,185
 124Ø DATA 187,185,197,162,3Ø,13,
 185,236
 125Ø DATA 187,185,197,189,51,177
 ,1Ø6,Ø
 126Ø DATA 188,225,183,77,174,84,
 173,45
 127Ø DATA 173,196,Ø,Ø,Ø,Ø,Ø,85
 128Ø DATA 85,85,85,85,85,85,85,8
 5
 129Ø DATA 85,85,85,85,85,85,85,8
 5
 13ØØ DATA 85,85,85,85,85,85,85,8
 5
 131Ø DATA 85,85,85,142,42,77,134
 ,13
 132Ø DATA 189,23,148,142,42,78,1
 34,19

133Ø DATA 189,23,148,142,42,79,1
 34,2Ø
 134Ø DATA 189,23,148,142,42,8Ø,1
 34,21
 135Ø DATA 189,23,148,142,42,82,1
 34,22
 136Ø DATA 189,23,148,142,42,83,1
 34,23
 137Ø DATA 189,23,148,142,42,84,1
 34,24
 138Ø DATA 189,23,148,142,42,85,1
 34,25
 139Ø DATA 189,23,148,57,7Ø,68,32
 ,13
 14ØØ DATA Ø,198,3Ø,247,2Ø,179,13
 4,255
 141Ø DATA 16,142,Ø,15,189,23,51,
 246
 142Ø DATA 2Ø,179,9Ø,193,1,39,5,2
 47
 143Ø DATA 2Ø,179,32,234,57,Ø,Ø,Ø
 144Ø DATA Ø,Ø,Ø,Ø,Ø,Ø,Ø,Ø
 145Ø DATA Ø,Ø,Ø,Ø,Ø,Ø,Ø,Ø
 146Ø DATA Ø,118,255,255,255,255,
 255,255
 147Ø DATA 255,255,255,255,255,25
 5,255,255
 148Ø DATA 255,255,255,255,255,25
 5,255,255
 149Ø DATA 255,255,255,255,255,25
 5,255,255
 15ØØ DATA 255,255,255,255,255,25
 5,255,84
 151Ø DATA 85,84,84,69,84,85,84,6
 6
 152Ø DATA 13,13,13,32,2,191,21,2
 2
 153Ø DATA 142,36,14,16,142,Ø,2,1
 34
 154Ø DATA 255,23Ø,132,189,23,51,
 48,1
 155Ø DATA 14Ø,36,33,46,2,32,236,
 19Ø
 156Ø DATA 21,22,57,Ø,Ø,Ø,Ø,Ø
 157Ø DATA Ø,Ø,Ø,Ø,Ø,Ø,Ø,Ø
 158Ø DATA Ø,Ø,Ø,Ø,Ø,Ø,Ø,Ø
 159Ø DATA Ø,Ø,Ø,Ø,Ø,Ø,Ø,Ø
 16ØØ DATA Ø,Ø,Ø,Ø,Ø,Ø,Ø,Ø
 161Ø DATA Ø,Ø,Ø,Ø,Ø,Ø,Ø,Ø
 162Ø DATA Ø,25,255,255,255,255,2
 55,255
 163Ø DATA 255,255,255,255,255,25
 5,255,255
 164Ø DATA 255,255,255,255,255,25
 5,255,55
 165Ø DATA 122,16,142,Ø,Ø,49,33,1
 6
 166Ø DATA 14Ø,15,16Ø,38,248,57,1
 98,5Ø
 167Ø DATA 16,142,Ø,4Ø,189,23,51,
 134

DIGISECTOR DS-69B **NEW** VIDEO DIGITIZER FOR THE COCO 3

(AND ALL OTHER COCOS . . .)

**SUPER
RESOLUTION !!!**



COCO 3 SCREEN

USE YOUR COCO 3 TO ITS FULL POTENTIAL!

Use The Micro Works' DIGISECTOR™ DS-69 or DS-69B and your COCO 3's high resolution graphics to capture and display television pictures from your VCR or video camera. The DIGISECTOR™ systems are the only COCO video digitizers available that accurately capture and reproduce the subtle shades of gray in TV pictures!

- **COLOR:** Add color to your screen for dramatic special effects.
- **HIGH RESOLUTION:** 256 by 256 spatial resolution.
- **PRECISION:** 64 levels of grey scale.
- **SPEED!** 8 images per second on DS-69B, 2 images per second DS-69.
- **COMPACTNESS:** Self contained in a plug-in Rompack.
- **EASY TO USE:** Software on disk will get you up and running fast!
- **COMPATIBLE:** Use with a black and white or color camera, a VCR or tuner.
- **INEXPENSIVE:** Our low price puts this within everyone's reach.

POWERFUL C-SEE 3.3 SOFTWARE

This menu-driven software will provide 5 and 16 shades of gray to the screen and to the printer with simple joystick control of brightness and contrast. Pictures taken by the DIGISECTOR™ may be saved on disk by C-SEE 3.3 and then edited by our optional MAGIGRAPH, or by COCO MAX or GRAPHICOM. This versatile new software is included in both DIGISECTORS™



DS-69B and C-SEE 3.3	\$149.95
DS-69 and C-SEE 3.3	\$ 99.95

TRADE IN YOUR OLD DIGISECTOR™

If you already have one of The Micro Works' DS-69 or DS-69A DIGISECTORS™, you may return it to us and we will upgrade your unit to a DS-69B.

UPGRADE DS-69A to DS-69B	\$49.95
UPGRADE DS-69 to DS-69B	\$69.95

The DS-69B comes with a one year warranty. Cameras and other accessories are available from The Micro Works.

NO RISK GUARANTEE

If you are not completely satisfied with the performance of your new DS-69B, you may return it, undamaged, within ten days for a full refund of the purchase price. We'll even pay the return shipping. If you can get any of our competitors to give you the same guarantee, buy both and return the one you don't like. We know which one you'll keep.

Purveyors of Fine Video Digitizers Since 1977.

**THE
MICRO
WORKS**

Terms: Visa, Mastercard, Check or C.O.D.

P.O. Box 1110 Del Mar, CA 92014 (619) 942-2400

```

168Ø DATA 255,198,3Ø,16,142,Ø,2Ø 179Ø DATA 255,255,255,255,255,83
,189 ,84,69
169Ø DATA 23,51,57,12Ø,246,21,11 180Ø DATA 83,84,7Ø,7Ø,7Ø,7Ø,8
9,9Ø 4
170Ø DATA 193,3Ø,37,5,247,21,119 181Ø DATA 85,84,66,65,83,73,67,6
,32 7
171Ø DATA 223,57,Ø,16,142,31,49, 182Ø DATA 67,67,67,67,67,67,67,6
189 7
172Ø DATA 37,37,57,Ø,Ø,Ø,Ø,Ø 183Ø DATA 67,67,67,67,67,67,255,
173Ø DATA Ø,Ø,Ø,Ø,Ø,Ø,Ø,Ø 134
174Ø DATA 5,185,161,161,222,7,25 184Ø DATA 255,198,5Ø,16,142,Ø,23
5,82 Ø,189
175Ø DATA 161,197,11,Ø,Ø,171,238 185Ø DATA 23,51,134,255,198,25,1
,161 6,142
176Ø DATA 181,1,2,221,161,161,2, 186Ø DATA Ø,115,189,23,51,134,25
4 5,198
177Ø DATA 3Ø,Ø,79,Ø,Ø,Ø,Ø,Ø 187Ø DATA 5Ø,16,142,Ø,23Ø,189,23
,51
178Ø DATA 27,255,255,255,255,255
,255,255

```

✓	27057	950235
	53030	1150227
	760206	END2

Listing 2: 2PART2

```

5 CLEAR 1ØØ,&H4FFE
1Ø REM #####
## RUN AFTER RUNNING ##
## 2PART1 SEE TEXT ##
#####
15 FOR X=24584 TO 25634:READ DT:
POKE X,DT:NEXT X
2Ø DATA 4,4,4,4,4,4,4,4
3Ø DATA 4,4,Ø,Ø,Ø,Ø,Ø,4
4Ø DATA Ø,Ø,Ø,4,Ø,4,Ø,4
5Ø DATA 4,Ø,Ø,Ø,Ø,Ø,Ø,Ø
6Ø DATA 4,Ø,4,Ø,1,4,Ø,4
7Ø DATA 3,Ø,4,Ø,4,4,Ø,4
8Ø DATA 4,Ø,Ø,Ø,4,3,Ø,4
9Ø DATA 4,4,4,4,4,4,4,4
1ØØ DATA 4,4,4,4,4,4,4,4
11Ø DATA 4,3,Ø,Ø,Ø,Ø,Ø,4
12Ø DATA 4,4,Ø,4,Ø,4,Ø,4
13Ø DATA Ø,Ø,Ø,4,Ø,4,4,4
14Ø DATA 4,4,4,4,Ø,4,Ø,Ø
15Ø DATA 4,4,Ø,Ø,Ø,Ø,Ø,4
16Ø DATA 4,3,Ø,4,1,4,Ø,4
17Ø DATA 4,4,4,4,4,4,4,4
18Ø DATA 4,4,4,4,4,4,4,4
19Ø DATA 4,Ø,Ø,Ø,Ø,Ø,Ø,Ø
2ØØ DATA 4,Ø,4,Ø,4,Ø,Ø,4
21Ø DATA 4,Ø,3,Ø,4,Ø,Ø,4
22Ø DATA Ø,Ø,4,Ø,4,Ø,Ø,4
23Ø DATA 4,4,4,Ø,Ø,Ø,Ø,4
24Ø DATA 4,3,Ø,Ø,4,4,1,4
25Ø DATA 4,4,4,4,4,4,4,4
26Ø DATA 4,4,4,4,4,4,4,4
27Ø DATA Ø,Ø,Ø,Ø,Ø,Ø,Ø,4
28Ø DATA 4,Ø,4,Ø,Ø,4,Ø,4
29Ø DATA 4,Ø,Ø,Ø,Ø,4,Ø,Ø
3ØØ DATA 4,Ø,4,Ø,Ø,4,Ø,4
31Ø DATA 3,Ø,4,Ø,Ø,4,Ø,4
32Ø DATA 4,Ø,4,Ø,Ø,Ø,Ø,2
33Ø DATA 4,4,4,1,4,4,4,4
34Ø DATA 4,4,4,4,4,4,4,4
35Ø DATA 4,Ø,Ø,Ø,4,Ø,4,4
36Ø DATA 4,Ø,4,Ø,Ø,Ø,Ø,Ø
37Ø DATA Ø,Ø,4,Ø,4,Ø,4,4
38Ø DATA 3,Ø,4,Ø,Ø,Ø,4,4
39Ø DATA 4,Ø,4,Ø,Ø,Ø,Ø,2
4ØØ DATA 4,Ø,4,1,4,4,4,4
41Ø DATA 4,4,4,4,4,4,4,4
42Ø DATA Ø,Ø,Ø,Ø,Ø,Ø,Ø,Ø
43Ø DATA Ø,Ø,Ø,Ø,Ø,Ø,Ø,Ø
44Ø DATA Ø,Ø,Ø,Ø,Ø,Ø,Ø,Ø
45Ø DATA Ø,Ø,Ø,Ø,Ø,Ø,Ø,Ø
46Ø DATA Ø,Ø,Ø,Ø,Ø,Ø,Ø,Ø
47Ø DATA Ø,Ø,Ø,Ø,Ø,Ø,Ø,Ø
48Ø DATA Ø,Ø,Ø,Ø,Ø,Ø,Ø,Ø
49Ø DATA Ø,Ø,Ø,Ø,Ø,Ø,Ø,Ø
5ØØ DATA Ø,Ø,Ø,Ø,Ø,Ø,Ø,Ø
51Ø DATA Ø,Ø,Ø,Ø,Ø,Ø,Ø,Ø
52Ø DATA 62,Ø,Ø,25Ø,58,Ø,Ø,171
53Ø DATA 42,Ø,Ø,163,58,Ø,Ø,135
54Ø DATA 54,Ø,Ø,147,5Ø,Ø,Ø,167
55Ø DATA 58,Ø,Ø,171,58,Ø,Ø,17Ø
56Ø DATA 62,Ø,Ø,171,Ø,Ø,Ø,16Ø
57Ø DATA 254,17Ø,17Ø,25Ø,7Ø,17Ø,
17Ø,164
58Ø DATA 19,168,17Ø,177,71,33,42
,18Ø
59Ø DATA 19,52,74,49,71,49,18,52
6ØØ DATA 19,52,71,49,71,33,19,52
61Ø DATA 255,42,255,63,Ø,Ø,Ø,Ø
62Ø DATA 85,85,87,234,253,87,212
,7Ø
63Ø DATA 255,87,245,18,255,223,2

```

44,70
 640 DATA 255,255,245,19,0,0,52,7
 1
 650 DATA 0,0,53,19,0,0,52,71
 660 DATA 0,0,55,255,0,0,52,0
 670 DATA 0,0,55,63,0,0,55,52
 680 DATA 0,0,55,49,0,0,55,52
 690 DATA 0,0,55,49,0,0,247,52
 700 DATA 247,255,215,49,213,255,
 215,52
 710 DATA 85,127,87,63,85,85,84,0
 720 DATA 43,21,85,85,33,21,253,8
 7
 730 DATA 55,23,255,87,51,23,255,
 223
 740 DATA 52,23,255,255,17,20,0,0
 750 DATA 52,20,0,0,49,20,0,0
 760 DATA 63,20,0,0,0,20,0,0
 770 DATA 254,20,0,0,70,20,0,0
 780 DATA 18,20,0,0,71,20,0,0
 790 DATA 19,20,0,0,71,23,0,0
 800 DATA 18,23,247,255,70,21,213
 ,255
 810 DATA 234,21,85,127,0,21,85,8
 5
 820 DATA 43,250,62,191,33,210,52
 ,71
 830 DATA 55,70,49,19,51,18,52,71
 840 DATA 52,69,49,19,17,17,20,69

850 DATA 52,69,33,17,49,18,36,70
 860 DATA 63,170,43,250,0,0,0,0
 870 DATA 254,42,191,63,70,49,19,
 52
 880 DATA 18,52,71,49,71,17,19,52
 890 DATA 19,20,207,49,71,17,55,5
 2
 900 DATA 18,36,118,49,70,33,210,
 36
 910 DATA 234,47,254,42,0,0,0,0
 920 DATA 2,128,10,160,170,170,25
 5,240
 930 DATA 63,48,63,252,31,255,23,
 240
 940 DATA 87,224,85,84,21,85,85,8
 5
 950 DATA 170,170,40,40,40,40,40,
 40
 960 DATA 42,42,48,224,51,96,53,2
 24
 970 DATA 46,96,51,96,51,95,53,22
 3
 980 DATA 46,95,51,95,48,223,59,1
 50
 990 DATA 47,6,52,10,59,156,54,13
 0
 1000 DATA 57,2,59,134,59,134,57,
 2
 1010 DATA 57,28,53,241,58,241,58



It's fun making your own Greeting Cards, Signs, and Banners.

Coco Graphics Designer Only \$29.95

The Coco Graphics Designer produces beautiful Greeting Cards, Banners, and Signs for holidays, birthdays and other occasions.

The program features picture, border, and character font editors, so that you can modify or expand the already built in libraries. Plus a special "grabber" utility is included to capture areas of high resolution screens for your picture library.

Requirements: a Coco I, II or III with at least 32K, one disk drive, BASIC 1.0/1.1, ADOS 1.0/1.1 or JDOS. Printers supported include: Epson RX/FX, Gemini 10X, SG10, NX10, DMP 100/105/110/130/430 CGP220, many Okidata (check with Zebra), Seikosha GP100/250, Gorilla Banana, Legend 808. Order #C323 Coco Graphics Designer

Picture Disk #1

This supplementary picture library diskette contains over one hundred additional pictures.

#C333 Picture Disk #1 \$14.95

Colored Paper Packs

150 sheets (50 each red, yellow, blue) with 60 matching envelopes. Perfect for making your productions outstanding.

#C274 Paper Pack \$19.95

Three New Picture Disks

We've hired freelance professional artists to expand the selection of pictures, and fonts available for our Coco Graphics Designer. We think you'll agree that the quality of their work is excellent. Each picture disk contains 128 pictures.

The selection of pictures has been guided by the requests we've received from our many Coco Graphics Designer customers. If we've missed drawing pictures for subjects that interest you, please submit your requests for our consideration.

Picture Disk #2 \$14.95

Special Occasions:

Party Hat, Cake, Gift Box, Champaigne, Juke Box, Saxophone, etc.

Sports:

Baseball, Basketball, Tennis, Running, etc.

Office:

Computer, File Cabinet, Memo Pad, Clip Board, etc.

American:

Flag, Eagle, Astronaut, Indian, Liberty Bell, etc.

Picture Disk #3 \$14.95

Religion:

Church, Cross, Candles, Menorah, Bible, Star, etc.

Animals:

Dogs, Cats, Tiger, Cow, Giraffe, Birds, Elephant, Turtle, Pig, Horse, etc.

Nature:

Flowers, Trees, Sunsets, Mountains, Lakes, etc.

Travel:

Car, Bus, Airplane, Taxi, Gas Pump, Tickets, etc.

Picture Disk #4 \$14.95

Includes these holidays and others...

Christmas: Tree, Star, Wreath, etc.
Easter: Egg, Bunny, Lillies, etc.
New Years: Calendar, Fireworks
Chanukah: Menorah, Star, etc.
Halloween: Pumpkin, Witch, etc.
Independence Day: Liberty Bell, Independence Hall, Fireworks, etc.
Presidents Day: Lincoln, Washington, etc.
Ground Hog Day: Ground Hog, Etc.

Two New Font Disks

Font Disk A \$14.95

Contains 10 Fonts

Font Disk B \$14.95

Contains 10 Fonts

NOTE: Our WICO Trackballs and Coco Car Sign Designer are still available. See our ad in the previous issue of Rainbow.

Ordering Instructions: All orders add \$3.00 Shipping & Handling. UPS COD add \$3.00. VISA/MC Accepted. NY residents add sales tax.

Zebra Systems, Inc.
 78-06 Jamaica Ave.
 Woodhaven, NY 11421
 (718) 296-2385

HOWARD MEDICAL COMPUTERS

1690 N. Elston • Chicago, IL 60622 • ORDERS (800) 443-1444 • INQUIRIES AND ORDER STATUS (312) 278-1440

★ 5 STAR FINAL

AUGUST '88

CLEAR

HMC CUTS \$515 to \$269

Hundreds of \$ off Monitors sighted as Major Factor. HMC is reported to have made a special purchase on Magnavox monitors. These items, listed, are being offered at remarkable savings.

MAGNAVOX 7622 12" Amber Screen offers 900 dots × 350 lines resolution at 20 MHz on a dark glass anti-glare CRT with built-in audio and 1 year warranty. (\$7 shipping) **\$88** 7652 green screen also available \$88

MAGNAVOX 8CM 515 has analog RGB for CoCo 3, TTL RGB for Tandy 1000 or IBM PC's, and composite color for CoCo 2 and 3. Built-in speaker. 14" screen with 640 dot × 240 line resolution. Plus 2 years parts and labor warranty. reg. list \$499 **was \$298 \$269** + \$14 Shipping

CC-3 Magnavox RGB cable only \$19.95 with Magnavox Monitor order. \$29.95 w/o monitor.



Savings have spread to the Zenith Line.

123A 12" This 12" green screen high resolution monitor offers 80 column capability, Zenith quality and a 90-day warranty valid at any of Zenith's 1200 locations. Retail \$199. **Our price \$67.50** (\$7 shipping) **REPACK**

VA-1 for monochrome and color monitors delivers video interface for CoCo's 1 & 2 **\$29.45** (\$2 shipping)

DRIVE Ø +. Howards Drive Ø gives you a DD-3 MPI drive, a CA-1 cable and a HDS DC-5 Disk Controller for only **\$178.45**. Double sided double density 360K. (\$5 shipping)
Add \$24 for a Disto DC-3

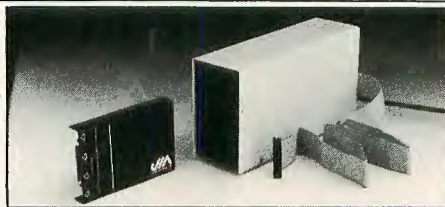

HMC's Guarantee— A Promise you can take to the Bank.

Howard Medical's 30-day guarantee is meant to eliminate the uncertainty of dealing with a company through the mail. Once you receive our hardware, try it out; test it for compatibility. If you're not happy with it for

any reason, return it in 30 days and we'll give you your money back (less shipping.) Shipping charges are for 48 states. APO, Canada and Puerto Rico orders are higher.

Buyout on DISTO Disk Controllers

Includes controller and C-DOS 4.0 ROM Chip. **DISTO \$98** DC-3 **A** (\$2 shipping on all DISTO products)

ADD-ON BOARDS

DC-3P Mini Eprom programmer includes all software to program 2764 or 27128 chips **B** **\$55**

DC-3C Clock Calendar and parallel printer port **C** **\$40**

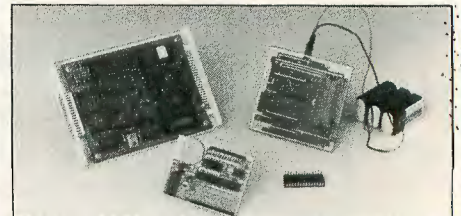

Items featured as evidence of Savings

INVESTIGATION OF "LOWEST PRICES" PROVES TRUE Disc Controllers, Add-On Board & Memory provide *absolute* proof.

"Howard Medical Computer offers the Lowest Prices.!" That was the claim that was tested and verified today as HMC unveiled undeniable savings on dozens of items

hotline number

DON'T MISS OUT,
DON'T MISS OUT, ORDER TODAY!

800 / 443-1444

WE ACCEPT VISA • MASTERCARD
• AMERICAN EXPRESS • C.O.D. OR
CHECKS • SCHOOL P.O.

The Biggest
The Best
The Indispensable

The RAINBOW

THE COLOR COMPUTER MONTHLY MAGAZINE

THE RAINBOW is the biggest, best, brightest and most comprehensive publication a happy CoCo ever had! **THE RAINBOW** features more programs, more information and more in-depth treatment of the Tandy Color Computer than any other source.

A monthly issue contains nearly 200 pages and up to two dozen programs, 14 regular columns and as many as 12 new product reviews. And advertisements: **THE RAINBOW** is known as *the* medium for advertisers — which means every month it has a wealth of information unavailable anywhere else about new products! Hundreds of programs are advertised in its pages each month.

Every single issue of **THE RAINBOW** covers the wide spectrum of interests in the Tandy Color Computer — from beginners' tutorials and arcade games to telecommunications and business and finance programs. Helpful utilities and do-it-yourself hardware projects make it easy and fun to expand your CoCo's capabilities. And, monthly reviews by independent reader reviewers take the guesswork out of buying new software and hardware products.

Join the tens of thousands who have found **THE RAINBOW** to be an absolute necessity for their CoCo. With all this going for it, is it surprising that more than 90 percent of **THE RAINBOW** subscribers renew their subscriptions? We're willing to bet that, a year from now, you'll be doing the same.

Rainbow On Tape & Rainbow On Disk!

— great ways to bring **THE RAINBOW** into your life. Each month, all you do is pop the tape into your cassette player or the disk into your drive. No more lost weekends. As soon as you read an article about a program in **THE RAINBOW**, it's ready to load and run. No work. No wait.

Just think how your software library will grow. With your first year's subscription, you'll get almost 250 new programs: games, utilities, business programs, home applications. And, with **RAINBOW ON DISK**, you'll also get all the OS-9 programs.

RAINBOW ON TAPE and **RAINBOW ON DISK** — they're the "meat" of **THE RAINBOW** at a price that's "small potatoes." And now you even have a choice about how it should be served up to you.

To get your first heaping helping, just fill out and return the attached reply card. No postage necessary.

NO POSTAGE
NECESSARY
IF MAILED
IN THE
UNITED STATES



BUSINESS REPLY CARD

FIRST CLASS PERMIT NO. 1 PROSPECT, KY

POSTAGE WILL BE PAID BY ADDRESSEE

RAINBOW
The COLOR COMPUTER MONTHLY MAGAZINE

The Falsoft Building

P.O. Box 385

Prospect, KY 40059-9989

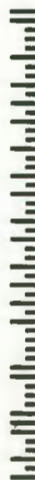

NO POSTAGE
NECESSARY
IF MAILED
IN THE
UNITED STATES



BUSINESS REPLY CARD

FIRST CLASS PERMIT NO. 1 PROSPECT, KY

POSTAGE WILL BE PAID BY ADDRESSEE

RAINBOW
The COLOR COMPUTER MONTHLY MAGAZINE

The Falsoft Building

P.O. Box 385

Prospect, KY 40059-9989

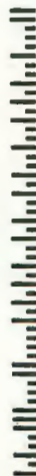

Use our 800 number!

For credit card orders, you may want to phone in your subscription. Our *credit card order* number is (800) 847-0309, 8 a.m. to 5 p.m. EST. All other inquiries please call (502) 228-4492.

We accept VISA, MasterCard and American Express.

Subscriptions to **THE RAINBOW** are \$31 a year in the United States. Canadian rate is \$38 (U.S. funds only). Surface rate elsewhere is \$68 (U.S.). Airmail is \$103 (U.S.). All subscriptions begin with the current issue. Please allow 6 to 8 weeks for the first copy. Kentucky residents add 5% sales tax. In order to hold down non-editorial costs, we do not bill.

Our 800 number is also good for ordering RAINBOW ON TAPE or RAINBOW ON DISK!

Just call (800) 847-0309 anytime from 8 a.m. to 5 p.m. EST. *Credit card orders only.* Subscriptions to **RAINBOW ON TAPE** are \$80 a year in the United States, \$90 (U.S. funds) in Canada and \$105 (U.S.) in all other countries.

RAINBOW ON DISK is \$99 a year in the United States, \$115 (U.S.) in Canada and \$130 (U.S.) in all other countries.

Individual issues of **RAINBOW ON TAPE** are \$10 in the U.S., \$12 (U.S.) in Canada and all other countries. Individual issues of **RAINBOW ON DISK** are \$12 in the U.S., \$14 (U.S.) in Canada, and \$16 (U.S.) in all other countries. Kentucky residents please add 5% sales tax.

RAINBOW ON TAPE and **RAINBOW ON DISK** are not stand-alone products; you need the magazine for loading and operating instructions and the necessary documentation. **THE RAINBOW** magazine is a separate purchase.

Send Me Rainbow Magazine!

Here's your chance to have a Pot O' Gold full of programs, articles and information about CoCo every month of the year!

As the premier magazine for the Tandy Color Computer, **THE RAINBOW** has more of everything — and greater variety, too. Do yourself and your CoCo a favor and subscribe to **THE RAINBOW** today!

YES! Sign me up for a year (12 issues) of **THE RAINBOW**.

NEW **RENEW (attach label)**

Name _____

Address _____

City _____ State _____ ZIP _____

Payment Enclosed (payment must accompany order)

Charge: VISA MasterCard American Express

Account Number _____

Signature _____ Card Expiration Date _____

Give Your Fingers A Break!

YES! Sign me up: **NEW** **RENEW (attach label)**

RAINBOW ON TAPE **RAINBOW ON DISK**
(Available beginning with the October 1986 issue)

A Full Year **Single Issue (specify month & year)** _____

Name _____

Address _____

City _____ State _____ ZIP _____

Payment Enclosed (payment must accompany order)

Charge: VISA MasterCard American Express

Account Number _____

Signature _____ Card Expiration Date _____

**\$500 CASH PRIZE
TO THE FIRST PLAYER TO SURVIVE!**

NIGHT OF THE LIVING DEAD

**AN INTERACTIVE
NIGHTMARE**

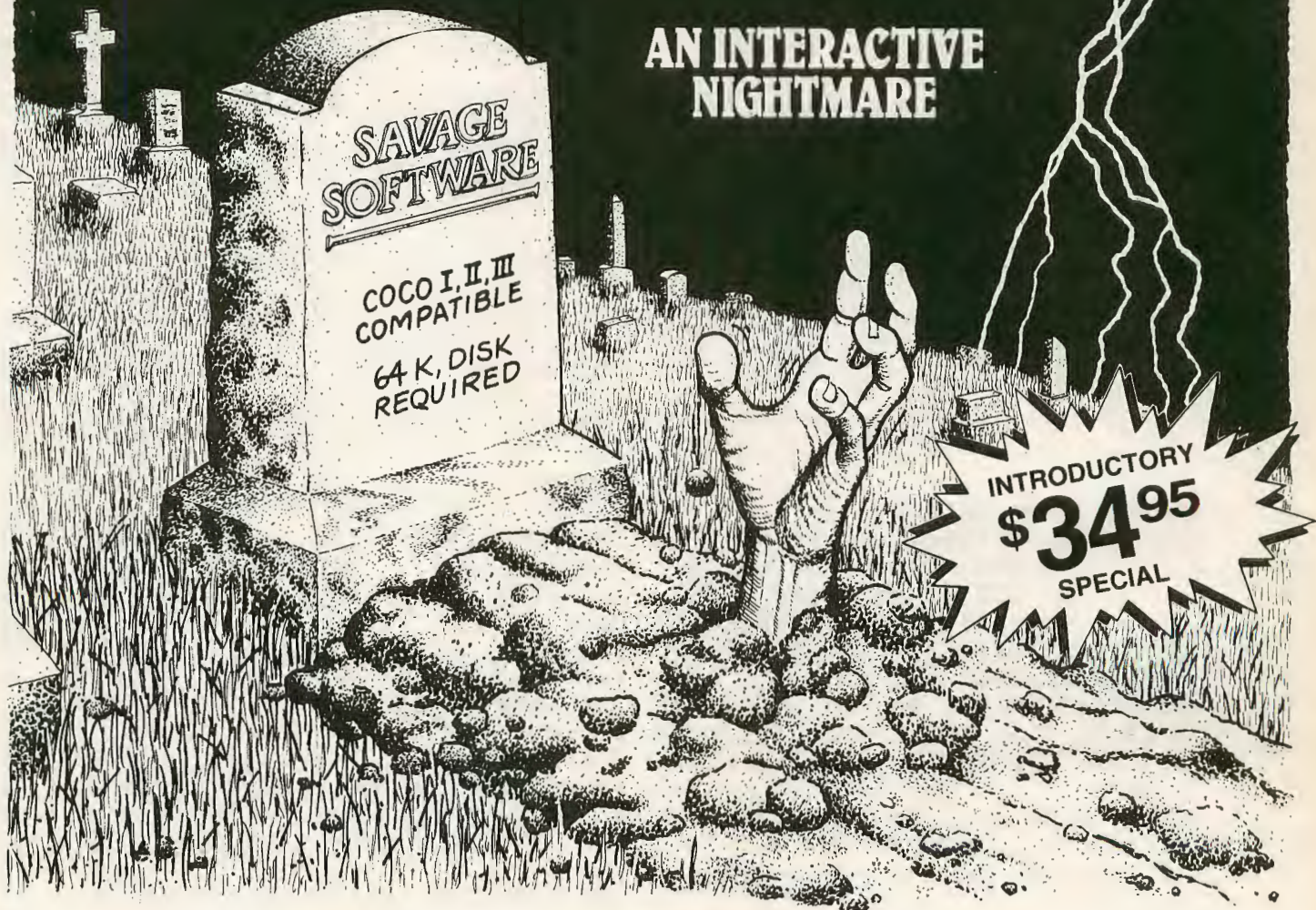

INTRODUCTORY
\$34.95
SPECIAL



ADVENTURE NOVEL SOFTWARE

P.O. BOX 8176, SPARTANBURG, SC 29305

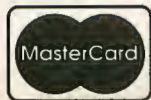

24 hr. order HOTLINE
(803) 578-7421
C.O.D. ADD \$5



```

,249
1020 DATA 61,109,58,237,255,255,
255,255
1030 DATA 255,255,0,0,63,252,31,
244
1040 DATA 19,196,6,144,8,32,32,8
1050 DATA 32,8,8,32,6,144,0,0
1060 DATA 21,4,5,17,1,65,10,161
1070 DATA 42,168,170,170,42,168,
10,160
1080 DATA 1,64,0,0,2,128,255,255
1090 DATA 61,124,61,124,182,158,
189,126
1100 DATA 63,252,63,252,255,255,
4,16
1110 DATA 1,64,3,192,1,64,5,144
1120 DATA 86,165,85,84,21,80,5,6
4
1130 DATA 1,64,42,168,170,170,15
7,222
1140 DATA 42,168,10,160,255,255,
36,24
1150 DATA 36,24,36,24,255,255,16
0,10
1160 DATA 168,42,41,104,43,232,9
,96

```

```

1170 DATA 9,96,0,64,0,16,4,64
1180 DATA 1,0,5,80,31,244,7,253
1190 DATA 1,244,0,80,1,66,5,3
1200 DATA 1,65,1,69,0,85,4,16
1210 DATA 17,132,67,193,7,208,17
,68
1220 DATA 67,193,7,208,17,68,66,
33
1230 DATA 0,0,0,20,0,85,0,117
1240 DATA 0,85,21,85,172,213,170
,165
1250 DATA 187,20,21,80,5,64,168,
21
1260 DATA 8,17,40,80,32,64,131,2
34
1270 DATA 171,194,1,8,5,40,68,32
1280 DATA 84,42,2,0,3,40,11,188
1290 DATA 11,238,46,172,187,188,
175,166
1300 DATA 126,224,126,192,24,0,0
,4
1310 DATA 0,18,0,18,1,18,1,42
1320 DATA 17,168,18,128,26,0,168
,0
1330 DATA 160,0,255,255,255,255,
255,255

```

✓	15038	1250154
	290236	1400101
	520228	1560113
	670223	1730103
	880219	END154
	1040135	

Listing 3: 3PART1

```

5 CLEAR 100,&H4FFE
10 REM #####
## RUN after LOADING ##
## TUT 1 SEE TEXT ##
#####
15 FOR X=20479 TO 21959:READ DT:
POKE X,DT:NEXT X
20 DATA 189,18,119,189,23,112,18
9,23
30 DATA 135,189,38,229,189,23,17
4,189
40 DATA 23,220,189,24,5,189,24,9
3
50 DATA 127,30,250,134,1,183,31,
54
60 DATA 183,31,55,134,240,183,31
,24
70 DATA 189,25,3,189,24,112,189,
25
80 DATA 200,189,27,14,189,27,90,
189
90 DATA 18,92,182,255,0,129,254,

```

```

39
100 DATA 4,129,126,38,245,189,37
,76
110 DATA 189,37,164,189,38,82,18
9,38
120 DATA 125,79,177,30,237,38,19
,189
130 DATA 20,10,182,255,0,129,254
,16
140 DATA 39,255,157,129,126,38,2
43,126
150 DATA 15,255,189,26,190,189,3
7,206
160 DATA 189,28,110,189,29,35,18
9,16
170 DATA 162,189,16,152,189,30,1
24,189
180 DATA 25,200,189,23,174,189,3
6,235
190 DATA 16,142,0,0,49,33,16,140
200 DATA 9,196,39,2,32,246,126,1
6
210 DATA 68,79,189,25,228,57,128
,184
220 DATA 255,15,57,182,39,116,12
9,180
230 DATA 36,7,139,60,183,39,116,
32
240 DATA 3,127,39,116,189,29,109
,57
250 DATA 57,255,255,255,255,255,
255,255

```

Computer Island Educational Software

BEYOND WORDS

32K Ext. - \$19.95 tape/\$24.95 disk
These Language Arts programs cover common misspellings, and synonyms/antonyms on each level. Additionally, Level 1 tests contractions and abbreviations, Level 2 tests homonyms, and Level 3 tests analogies. Each program has three parts and contains over 400 questions and uses over 800 words. All tests are grade appropriate. User modifiable (directions included). Printer option. Specify Level.

- Level 1 Grades 3-5
- Level 2 Grades 6-8
- Level 3 Grades 9-12



VOCABULARY BUILDER

32K Ext. - \$19.95 tape/\$24.95 disk
200 Vocabulary questions on appropriate grade levels in a 4 part multiple choice format. 1000 words used. Extensive research has provided challenging words on all levels. When mastered, the words may be changed by the user (full directions included). Printer option. Specify Level.

- Level 1 Grades 3-5
- Level 2 Grades 6-8
- Level 3 Grades 9-12

CONTEXT CLUES - 4, 5, 6, 7

16K Ext. - \$17.95 tape/\$22.95 disk
Each reading program contains about 50 situational paragraphs with one key word missing. Child uses context clues to find correct answer in multiple choice format. Random selection of readings each round. Specify 4th, 5th, 6th, or 7th grade.

CONTEXT CLUES - 2-3

32K Ext. - \$19.95 tape/\$24.95 disk
A reading program wherein the child uses the context to choose the correct answer. Multiple choice format. Hi-res screen. Grades 2-3.

TRIGONOMETRY TUTOR

32K Ext. - \$19.95 tape/\$24.95 disk
A step by step tutorial for learning to compute the sides and angles of right triangles. All examples have graphic representation. Help commands and cursor aids assist throughout.



OPENING A BANK ACCOUNT

32K Ext. - \$24.95 disk only
A set of programs designed to introduce and provide practice in the skills of filling out bank applications, deposit and withdrawal slips, and computing bank account balances. Loaded with graphic presentations. Grades 3-8.

EQUATIONS TUTOR

32K Ext. - \$19.95 tape/\$24.95 disk
Elementary-Intermediate algebra. Step by step tutorials. Multi-level. SPECIFY Linear or Quadratic.

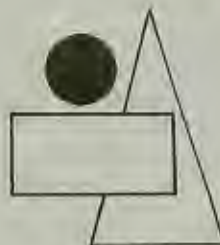

AREA & PERIMETER

32K Ext. - \$19.95 tape/\$24.95 disk
Triangles, rectangles, and circles and covered in this Hi-res text and graphic program.

COCO WHEEL OF FORTUNE

32K Ext. - \$19.95 tape/\$24.95 disk
Hi-res graphics and screen in this version of the popular TV show. One to six players. Spin the wheel for points and guess a letter to solve the puzzle. Over 200 puzzles. Have fun while strengthening language arts skills.

MATH INVADERS

32K Ext. - \$17.95 tape/\$22.95 disk
A multi-level "Space Invaders" type game to reinforce the 4 basic math operations (addition, subtraction, multiplication and division). Problems become more difficult as your progress. Hi-res graphics. Joystick required.



(718) 948-2748

Dept. R 227 Hampton Green, Staten Island, N.Y. 10312



Send for catalog with complete descriptions.

Please add \$1.00 per order for postage. N.Y. residents, please add proper tax. FREE set of BINARY DICE, including full directions, with orders of 2 or more items.

Dealer Inquiries Invited.

TRS-80 Color Computer

All Payments in U.S. Funds.

260 DATA 255,0,0,0,0,0,0,0
 270 DATA 0,0,0,0,0,134,128,184
 280 DATA 255,15,182,255,15,183,4,
 0
 290 DATA 32,243,0,0,0,0,0,0
 300 DATA 0,0,0,0,4,0,0,0
 310 DATA 0,0,0,0,0,0,0,0
 320 DATA 4,0,0,0,0,0,0,0
 330 DATA 0,0,0,0,0,0,0,0
 340 DATA 83,251,255,255,255,255,
 255,255
 350 DATA 255,255,255,255,255,255,
 255,255
 360 DATA 255,255,255,255,255,255,
 255,255
 370 DATA 255,255,255,255,255,255,
 255,255
 380 DATA 255,255,255,255,255,255,
 255,255
 390 DATA 255,255,255,255,255,255,
 255,255
 400 DATA 255,255,255,255,255,255,
 255,255
 410 DATA 255,255,255,255,255,255,
 255,255
 420 DATA 255,0,0,0,0,0,0,0
 430 DATA 0,0,0,0,0,0,0,0
 440 DATA 0,0,0,0,0,0,0,0
 450 DATA 0,0,0,0,0,0,0,0
 460 DATA 0,0,0,0,0,0,0,0
 470 DATA 0,0,0,0,0,0,0,0
 480 DATA 0,0,0,0,0,0,0,0
 490 DATA 0,0,0,0,0,0,0,0
 500 DATA 35,255,255,255,255,255,
 255,255
 510 DATA 255,255,255,255,255,255,
 255,255
 520 DATA 255,255,255,255,255,189,
 21,224
 530 DATA 189,21,224,189,21,224,1
 27,255
 540 DATA 201,127,255,34,127,255,
 202,127
 550 DATA 255,206,127,255,192,127,
 255,194
 560 DATA 127,255,196,142,17,248,
 16,142
 570 DATA 4,0,95,166,128,167,160,
 92
 580 DATA 193,78,39,2,32,245,182,
 30
 590 DATA 220,139,48,183,4,78,182,
 30
 600 DATA 221,139,48,183,4,79,182,
 30
 610 DATA 222,139,48,183,4,80,182,
 30
 620 DATA 223,139,48,183,4,81,134,
 48
 630 DATA 183,4,82,127,15,160,57,
 4
 640 DATA 4,0,0,0,0,0,0,0
 650 DATA 0,3,15,14,7,18,1,20
 660 DATA 21,12,1,20,9,15,14,19
 670 DATA 32,25,15,21,32,1,18,5
 680 DATA 32,20,8,5,32,32,32,32
 690 DATA 32,19,15,12,5,32,19,21
 700 DATA 18,22,9,22,15,18,32,32
 710 DATA 32,32,32,32,32,32,32,32
 720 DATA 32,32,32,32,32,32,32,32
 730 DATA 32,25,15,21,18,32,19,3
 740 DATA 15,18,5,32,9,19,32,0
 750 DATA 0,0,0,0,0,0,0,0
 760 DATA 0,0,0,0,0,0,0,0
 770 DATA 0,0,0,0,0,134,255,183
 780 DATA 43,196,183,43,197,183,4
 3,198
 790 DATA 183,43,199,183,43,164,1
 83,43
 800 DATA 165,183,43,166,183,43,1
 67,57
 810 DATA 182,15,160,129,100,38,1
 00,182
 820 DATA 30,220,177,30,230,34,32,
 37
 830 DATA 54,182,30,221,177,30,23
 1,34
 840 DATA 22,37,44,182,30,222,177,
 30
 850 DATA 232,34,12,37,34,182,30,
 223
 860 DATA 177,30,233,34,2,32,24,1
 82
 870 DATA 30,220,183,30,230,182,3
 0,221
 880 DATA 183,30,231,182,30,222,1
 83,30
 890 DATA 232,182,30,223,183,30,2
 33,189
 900 DATA 21,224,189,21,224,134,3
 ,183
 910 DATA 30,237,182,15,161,183,3
 0,220
 920 DATA 182,15,162,183,30,221,1
 82,15
 930 DATA 163,183,30,222,182,15,1
 64,183
 940 DATA 30,223,57,63,4,0,0,0
 950 DATA 0,0,4,0,4,0,4,0
 960 DATA 4,0,0,0,0,0,0,0
 970 DATA 0,0,0,0,0,0,0,0
 980 DATA 194,251,255,255,255,255,
 255,255
 990 DATA 255,187,185,197,161,222,
 7,255
 1000 DATA 82,161,197,11,0,0,171,
 238
 1010 DATA 161,181,1,2,221,161,16
 1,2
 1020 DATA 4,160,240,0,255,255,25
 5,255
 1030 DATA 255,255,255,255,255,25

5,255,255
 1040 DATA 255,255,255,255,255,25
 5,255,255
 1050 DATA 255,255,255,255,255,25
 5,255,255
 1060 DATA 255,0,0,0,0,0,0,0
 1070 DATA 0,0,0,0,0,0,0,0
 1080 DATA 0,0,0,0,0,0,0,0
 1090 DATA 0,0,0,0,0,0,0,0
 1100 DATA 0,0,0,0,0,0,0,0
 1110 DATA 0,0,0,0,0,0,0,0
 1120 DATA 0,0,0,0,0,0,0,0
 1130 DATA 0,0,0,0,0,0,0,0
 1140 DATA 193,255,255,255,255,25
 5,74,32
 1150 DATA 32,255,255,255,255,255
 ,255,255
 1160 DATA 255,255,255,255,255,25
 5,255,255
 1170 DATA 255,255,255,255,255,25
 5,255,255
 1180 DATA 255,255,255,255,255,25
 5,255,255
 1190 DATA 255,255,255,255,255,25
 5,255,255
 1200 DATA 255,255,255,255,255,25
 5,255,255
 1210 DATA 255,255,255,255,255,25
 5,255,255
 1220 DATA 255,0,0,0,0,0,0,0
 1230 DATA 0,0,0,0,0,0,28,185
 1240 DATA 187,185,197,162,30,13,
 185,236
 1250 DATA 187,185,197,189,51,177
 ,106,0
 1260 DATA 188,225,183,77,174,84,
 173,45
 1270 DATA 173,196,0,0,0,0,0,85
 1280 DATA 85,85,85,85,85,85,85,8
 5
 1290 DATA 85,85,85,85,85,85,85,8
 5
 1300 DATA 85,85,85,85,85,85,85,8
 5
 1310 DATA 85,85,85,142,42,77,134
 ,13
 1320 DATA 189,23,148,142,42,78,1
 34,19
 1330 DATA 189,23,148,142,42,79,1
 34,20
 1340 DATA 189,23,148,142,42,80,1
 34,21
 1350 DATA 189,23,148,142,42,82,1
 34,22
 1360 DATA 189,23,148,142,42,83,1
 34,23
 1370 DATA 189,23,148,142,42,84,1
 34,24
 1380 DATA 189,23,148,142,42,85,1
 34,25
 1390 DATA 189,23,148,57,70,68,32

The RAINBOW

THE COLOR COMPUTER MONTHLY MAGAZINE

Back Issue Availability

For greater convenience, order RAINBOW Back Issues through the Rainbow Magazine Services area of our Delphi CoCo SIG.

BACK ISSUES STILL AVAILABLE

Have you explored the wealth of information in our past issues? From our very first, four-page issue to many with more than 300 pages of material, it's all just for CoCo users — a great way to expand your library!

A WORLD OF INFO AT A BARGAIN PRICE

All back issues sell for the single issue cover price. In addition, there is a \$3.50 charge for the first issue, plus 50 cents for each additional issue for postage and handling if sent by United Parcel Service. There is a \$5 charge for the first issue, plus a \$1 charge for each additional issue on orders sent by U.S. Mail. UPS *will not* deliver to a post office box or to another country.

MOST ISSUES STILL AVAILABLE

Issues July 1981 through June 1982 are available on white paper in a reprint form. All others are in regular magazine form. VISA, MasterCard and American Express accepted. Kentucky residents please add 5 percent state sales tax. In order to hold down costs, we do not bill, and no C.O.D. orders are accepted.

Due to heavy demand, we suggest you order the back issues you want now while supplies last.

To check availability and order, review and fill out the form on the next page and mail it with your payment to:

THE RAINBOW
 The Falsoft Building
 P.O. Box 385
 Prospect, KY 40059

BACK ISSUE ORDER FORM

(See overleaf for instructions.)

Please send me the following back issues:

MONTH/YEAR	PRICE	MONTH/YEAR	PRICE
VOLUME 1		VOLUME 5	
JUL '81 Premier Issue	\$2.00 <input type="checkbox"/>	AUG '85 Games	\$3.95 <input type="checkbox"/>
AUG '81	\$2.00 <input type="checkbox"/>	SEP '85 Education	\$3.95 <input type="checkbox"/>
SEP '81 Education	\$2.00 <input type="checkbox"/>	OCT '85 Graphics	\$3.95 <input type="checkbox"/>
OCT '81 Printer	\$2.00 <input type="checkbox"/>	NOV '85 Data Comm.	\$3.95 <input type="checkbox"/>
NOV '81	\$2.00 <input type="checkbox"/>	JAN '86 Beginners	\$3.95 <input type="checkbox"/>
DEC '81 Holiday	\$2.00 <input type="checkbox"/>	FEB '86 Utilities	\$3.95 <input type="checkbox"/>
JAN '82	\$2.00 <input type="checkbox"/>	MAR '86 Business	\$3.95 <input type="checkbox"/>
FEB '82	\$2.00 <input type="checkbox"/>	APR '86 Home Help	\$3.95 <input type="checkbox"/>
MAR '82	\$2.50 <input type="checkbox"/>	MAY '86 Printer	\$3.95 <input type="checkbox"/>
APR '82	\$2.50 <input type="checkbox"/>	JUN '86 Music	\$3.95 <input type="checkbox"/>
JUN '82	\$2.50 <input type="checkbox"/>	JUL '86 Anniversary	\$3.95 <input type="checkbox"/>
VOLUME 2		VOLUME 6	
JUN '83 Printers	\$2.95 <input type="checkbox"/>	AUG '86 Games	\$3.95 <input type="checkbox"/>
JUL '83 Anniversary	\$2.95 <input type="checkbox"/>	SEP '86 Education	\$3.95 <input type="checkbox"/>
VOLUME 3		OCT '86 Graphics	\$3.95 <input type="checkbox"/>
AUG '83 Games	\$2.95 <input type="checkbox"/>	NOV '86 Data Comm.	\$3.95 <input type="checkbox"/>
SEP '83 Education	\$2.95 <input type="checkbox"/>	DEC '86 Holiday	\$3.95 <input type="checkbox"/>
OCT '83 Graphics	\$3.95 <input type="checkbox"/>	JAN '87 Beginners	\$3.95 <input type="checkbox"/>
DEC '83 Holiday	\$3.95 <input type="checkbox"/>	FEB '87 Utilities	\$3.95 <input type="checkbox"/>
MAR '84 Business	\$3.95 <input type="checkbox"/>	MAR '87 Business	\$3.95 <input type="checkbox"/>
APR '84 Gaming	\$3.95 <input type="checkbox"/>	APR '87 Home Help	\$3.95 <input type="checkbox"/>
MAY '84 Printer	\$3.95 <input type="checkbox"/>	MAY '87 Printer	\$3.95 <input type="checkbox"/>
JUN '84 Music	\$3.95 <input type="checkbox"/>	JUN '87 Music	\$3.95 <input type="checkbox"/>
JUL '84 Anniversary	\$3.95 <input type="checkbox"/>	JUL '87 Anniversary	\$3.95 <input type="checkbox"/>
VOLUME 4		VOLUME 7	
AUG '84 Games	\$3.95 <input type="checkbox"/>	AUG '87 Games	\$3.95 <input type="checkbox"/>
SEP '84 Education	\$3.95 <input type="checkbox"/>	SEP '87 Education	\$3.95 <input type="checkbox"/>
OCT '84 Graphics	\$3.95 <input type="checkbox"/>	OCT '87 Graphics	\$3.95 <input type="checkbox"/>
NOV '84 Data Comm.	\$3.95 <input type="checkbox"/>	NOV '87 Data Comm.	\$3.95 <input type="checkbox"/>
DEC '84 Holiday	\$3.95 <input type="checkbox"/>	DEC '87 Holiday	\$3.95 <input type="checkbox"/>
JAN '85 Beginners	\$3.95 <input type="checkbox"/>	JAN '88 Beginners	\$3.95 <input type="checkbox"/>
FEB '85 Utilities	\$3.95 <input type="checkbox"/>	FEB '88 Utilities	\$3.95 <input type="checkbox"/>
MAR '85 Business	\$3.95 <input type="checkbox"/>	MAR '88 Business	\$3.95 <input type="checkbox"/>
APR '85 Simulations	\$3.95 <input type="checkbox"/>	APR '88 Home Help	\$3.95 <input type="checkbox"/>
MAY '85 Printer	\$3.95 <input type="checkbox"/>	MAY '88 Printer	\$3.95 <input type="checkbox"/>
JUN '85 Music	\$3.95 <input type="checkbox"/>	JUN '88 Music	\$3.95 <input type="checkbox"/>
JUL '85 Anniversary	\$3.95 <input type="checkbox"/>	JUL '88 Anniversary	\$3.95 <input type="checkbox"/>
		VOLUME 8	
		AUG '88 Games	\$3.95 <input type="checkbox"/>

RAINBOW INDEX A complete index to the first three years, July 1981 through June 1984, is printed in the July 1984 issue. Separate copies are available for \$2.50

The Fourth, Fifth and Sixth Year Indexes including RAINBOW ON TAPE are printed in the July 1985, 1986 and 1987 issues, respectively. The Seventh Year Index is printed in the July 1988 issue.

TOTAL _____

KY RESIDENTS ADD 5% _____

U.S. MAIL CHARGE _____

SHIPPING & HANDLING _____

U.P.S. CHARGE _____

TOTAL AMOUNT _____

ENCLOSED _____

Article Reprints

In instances where a given issue is now out of print and not available for purchase, we do provide photocopies of specific articles. The cost for this service is \$1.50 plus 50 cents S/H per article. This service is provided *only* in the case of out-of-stock issues.

Name _____

Address _____

City _____ State _____ ZIP _____

Payment Enclosed, or

Charge to my: VISA MC AE

CARD # _____

EXPIRATION DATE _____ PHONE () _____

SIGNATURE _____

TO ORDER BY PHONE (credit card orders only) call (800) 847-0309, 8 a.m. to 5 p.m. EST. All other inquiries call (502) 228-4492.

, 13
 1400 DATA 0,198,30,247,20,179,13
 4,255
 1410 DATA 16,142,0,15,189,23,51,
 246
 1420 DATA 20,179,90,193,1,39,5,2
 47
 1430 DATA 20,179,32,234,57,0,0,0
 1440 DATA 0,0,0,0,0,0,0,0
 1450 DATA 0,0,0,0,0,0,0,0
 1460 DATA 0,118,255,255,255,255,
 255,255
 1470 DATA 255,255,255,255,255,25
 5,255,255
 1480 DATA 255,255,255,255,255,25
 5,255,255
 1490 DATA 255,255,255,255,255,25
 5,255,255
 1500 DATA 255,255,255,255,255,25
 5,255,84
 1510 DATA 85,84,84,69,84,85,84,6
 6
 1520 DATA 13,13,13,32,2,191,21,2
 2
 1530 DATA 142,36,14,16,142,0,2,1
 34
 1540 DATA 255,230,132,189,23,51,
 48,1
 1550 DATA 140,36,33,46,2,32,236,
 190
 1560 DATA 21,22,57,0,0,0,0,0
 1570 DATA 0,0,0,0,0,0,0,0
 1580 DATA 0,0,0,0,0,0,0,0
 1590 DATA 0,0,0,0,0,0,0,0
 1600 DATA 0,0,0,0,0,0,0,0
 1610 DATA 0,0,0,0,0,0,0,0
 1620 DATA 0,25,255,255,255,255,2
 55,255
 1630 DATA 255,255,255,255,255,25
 5,255,255
 1640 DATA 255,255,255,255,255,25
 5,255,58
 1650 DATA 40,16,142,0,0,49,33,16
 1660 DATA 140,15,160,38,248,57,1
 98,50
 1670 DATA 16,142,0,40,189,23,51,
 134
 1680 DATA 255,198,30,16,142,0,20
 ,189
 1690 DATA 23,51,57,120,246,21,11
 9,90
 1700 DATA 193,30,37,5,247,21,119
 ,32
 1710 DATA 223,57,0,16,142,31,49,
 189
 1720 DATA 37,37,57,0,0,0,0,0
 1730 DATA 0,0,0,0,0,0,0,0
 1740 DATA 5,185,161,161,222,7,25
 5,82
 1750 DATA 161,197,11,0,0,171,238
 ,161

```

176Ø DATA 181,1,2,221,161,161,2,
4
177Ø DATA 3Ø,Ø,79,Ø,Ø,Ø,Ø,Ø
178Ø DATA 27,255,255,255,255,255
,255,255
179Ø DATA 255,255,255,255,255,83
,84,69
180ØØ DATA 83,84,7Ø,7Ø,7Ø,7Ø,7Ø,8
4
181Ø DATA 85,84,66,65,83,73,67,6
7
182Ø DATA 67,67,67,67,67,67,67,6
7
183Ø DATA 67,67,67,67,67,67,255,
134
184Ø DATA 255,198,5Ø,16,142,Ø,23
Ø,189
185Ø DATA 23,51,134,255,198,25,1
6,142
186Ø DATA Ø,115,189,23,51,134,25
5,198
187Ø DATA 5Ø,16,142,Ø,23Ø,189,23
,51

```

✓	270	4
	530	234
	760	154
	950	183
	1150	221
	END	252

Listing 4: 3PART2

```

5 CLEAR 1ØØ,&H4FFE
1Ø REM #####
## RUN AFTER LOADING ##
## 3PART1 SEE TEXT ##
#####
15 FOR X=24584 TO 25634:READ DT:
POKE X,DT:NEXT X
2Ø DATA 4,4,4,4,4,4,4,4
3Ø DATA 4,4,Ø,Ø,Ø,Ø,Ø,4
4Ø DATA 4,Ø,Ø,Ø,Ø,Ø,Ø,4
5Ø DATA Ø,Ø,Ø,4,1,4,Ø,4
6Ø DATA 4,Ø,Ø,Ø,Ø,Ø,Ø,4
7Ø DATA 4,Ø,4,4,Ø,Ø,Ø,Ø
8Ø DATA 3,Ø,4,3,Ø,Ø,Ø,4
9Ø DATA 4,4,4,4,4,4,4,4
1ØØ DATA 4,4,4,4,4,4,4,4
11Ø DATA 4,Ø,Ø,Ø,Ø,Ø,Ø,Ø
12Ø DATA 4,Ø,1,Ø,4,Ø,Ø,4
13Ø DATA 4,Ø,4,Ø,4,4,Ø,4
14Ø DATA 4,Ø,4,Ø,Ø,3,Ø,4
15Ø DATA Ø,Ø,4,Ø,4,4,Ø,4
16Ø DATA 4,Ø,Ø,Ø,2,4,Ø,4
17Ø DATA 4,4,4,4,4,4,4,4
18Ø DATA 4,4,4,4,4,4,4,4
19Ø DATA Ø,Ø,Ø,Ø,Ø,Ø,Ø,4
2ØØ DATA 4,4,Ø,4,4,4,Ø,4

```

```

21Ø DATA 4,Ø,Ø,Ø,Ø,Ø,Ø,4
22Ø DATA 3,Ø,4,1,4,Ø,4,4
23Ø DATA 4,Ø,4,4,Ø,Ø,4,4
24Ø DATA 4,Ø,3,Ø,Ø,Ø,Ø,Ø
25Ø DATA 4,4,4,4,4,4,4,4
26Ø DATA 4,4,4,4,4,4,4,4
27Ø DATA 4,Ø,4,4,Ø,Ø,Ø,2
28Ø DATA 4,Ø,2,4,Ø,Ø,Ø,4
29Ø DATA 4,Ø,4,4,Ø,Ø,Ø,4
3ØØ DATA 4,Ø,4,Ø,Ø,Ø,Ø,Ø
31Ø DATA 4,Ø,Ø,Ø,4,1,4,4
32Ø DATA Ø,Ø,Ø,Ø,Ø,Ø,4,4
33Ø DATA 4,4,4,4,4,4,4,4
34Ø DATA 4,4,4,4,4,4,4,4
35Ø DATA 4,Ø,2,4,Ø,Ø,Ø,4
36Ø DATA 4,Ø,4,4,Ø,4,Ø,4
37Ø DATA 4,Ø,4,4,Ø,4,Ø,4
38Ø DATA Ø,Ø,4,4,Ø,4,Ø,4
39Ø DATA 4,Ø,Ø,Ø,Ø,4,Ø,4
4ØØ DATA 3,Ø,Ø,Ø,Ø,4,Ø,4
41Ø DATA 4,4,4,4,1,4,4,4
42Ø DATA Ø,Ø,Ø,Ø,Ø,Ø,Ø,Ø
43Ø DATA Ø,Ø,Ø,Ø,Ø,Ø,Ø,Ø
44Ø DATA Ø,Ø,Ø,Ø,Ø,Ø,Ø,Ø
45Ø DATA Ø,Ø,Ø,Ø,Ø,Ø,Ø,Ø
46Ø DATA Ø,Ø,Ø,Ø,Ø,Ø,Ø,Ø
47Ø DATA Ø,Ø,Ø,Ø,Ø,Ø,Ø,Ø
48Ø DATA Ø,Ø,Ø,Ø,Ø,Ø,Ø,Ø
49Ø DATA Ø,Ø,Ø,Ø,Ø,Ø,Ø,Ø
5ØØ DATA Ø,Ø,Ø,Ø,Ø,Ø,Ø,Ø
51Ø DATA Ø,Ø,Ø,Ø,Ø,Ø,Ø,Ø
52Ø DATA 62,Ø,Ø,25Ø,58,Ø,Ø,171
53Ø DATA 42,Ø,Ø,163,58,Ø,Ø,135
54Ø DATA 54,Ø,Ø,147,5Ø,Ø,Ø,167
55Ø DATA 58,Ø,Ø,171,58,Ø,Ø,17Ø
56Ø DATA 62,Ø,Ø,171,Ø,Ø,Ø,16Ø
57Ø DATA 254,17Ø,17Ø,25Ø,7Ø,17Ø,
17Ø,164
58Ø DATA 19,168,17Ø,177,71,33,42
,18Ø
59Ø DATA 19,52,74,49,71,49,18,52
6ØØ DATA 19,52,71,49,71,33,19,52
61Ø DATA 255,42,255,63,Ø,Ø,Ø,Ø
62Ø DATA 85,85,87,234,253,87,212
,7Ø
63Ø DATA 255,87,245,18,255,223,2
44,7Ø
64Ø DATA 255,255,245,19,Ø,Ø,52,7

```

GET THE BEST !!!

Excellent 36 Disk CoCo Software Library \$95.00
includes Word Processor, Modems, Utilities, 124 Games,
Graphics/Pics, Business, Languages, Music and More.
Public Domain and Shareware. Over 850 Programs.
15% Discount to User Groups and Students. Major Credit
Cards Welcomed. Call Sandra or Joe at 1-800-221-7372.

SUMMER SPECIAL SALE

Please add \$4.50 for Shipping and Handling

Public Domain Software Copying Company
33 Gold Street-Suite L3
New York, N.Y. 10038

1
65Ø DATA Ø,Ø,53,19,Ø,Ø,52,71
66Ø DATA Ø,Ø,55,255,Ø,Ø,52,Ø
67Ø DATA Ø,Ø,55,63,Ø,Ø,55,52
68Ø DATA Ø,Ø,55,49,Ø,Ø,55,52
69Ø DATA Ø,Ø,55,49,Ø,Ø,247,52
70Ø DATA 247,255,215,49,213,255,
215,52
71Ø DATA 85,127,87,63,85,85,84,Ø
72Ø DATA 43,21,85,85,33,21,253,8
7
73Ø DATA 55,23,255,87,51,23,255,
223
74Ø DATA 52,23,255,255,17,2Ø,Ø,Ø
75Ø DATA 52,2Ø,Ø,Ø,49,2Ø,Ø,Ø
76Ø DATA 63,2Ø,Ø,Ø,Ø,2Ø,Ø,Ø
77Ø DATA 254,2Ø,Ø,Ø,7Ø,2Ø,Ø,Ø
78Ø DATA 18,2Ø,Ø,Ø,71,2Ø,Ø,Ø
79Ø DATA 19,2Ø,Ø,Ø,71,23,Ø,Ø
80Ø DATA 18,23,247,255,7Ø,21,213
,255
81Ø DATA 234,21,85,127,Ø,21,85,8
5
82Ø DATA 43,25Ø,62,191,33,21Ø,52
,71
83Ø DATA 55,7Ø,49,19,51,18,52,71
84Ø DATA 52,69,49,19,17,17,2Ø,69
85Ø DATA 52,69,33,17,49,18,36,7Ø
86Ø DATA 63,17Ø,43,25Ø,Ø,Ø,Ø,Ø
87Ø DATA 254,42,191,63,7Ø,49,19,
52
88Ø DATA 18,52,71,49,71,17,19,52
89Ø DATA 19,2Ø,2Ø7,49,71,17,55,5
2
90Ø DATA 18,36,118,49,7Ø,33,21Ø,
36
91Ø DATA 234,47,254,42,Ø,Ø,Ø,Ø
92Ø DATA 2,128,1Ø,16Ø,17Ø,17Ø,25
5,24Ø
93Ø DATA 63,48,63,252,31,255,23,
24Ø
94Ø DATA 87,224,85,84,21,85,85,8
5
95Ø DATA 17Ø,17Ø,4Ø,4Ø,4Ø,4Ø,4Ø,
4Ø
96Ø DATA 42,42,51,96,56,96,46,96
97Ø DATA 58,224,53,224,56,95,46,
95
98Ø DATA 58,223,53,223,58,219,59
,142
99Ø DATA 54,15Ø,54,13Ø,49,136,47
,8
100ØØ DATA 59,13Ø,59,144,59,138,4
7,28

The Rainbow Introductory Guide to Statistics

Most people have been using statistics since they learned to talk. Statistical results and concepts turn up everywhere. A large part of our daily news consists of statistics. Results of opinion polls, surveys, research studies, the Dow Jones industrial average and, of course, our sports news are all statistics. But statistics are often misused. The informed person needs to understand the basic concepts in order to judge the appropriateness of applications.

Rainbow Contributing Editor Dr. Michael Plog and co-author Dr. Norman Stenzel have written **The Rainbow Introductory Guide to Statistics** just for beginners. It is an easy-to-understand guide to this sometimes mysterious area of mathematics. Their aim is to introduce readers to the realm of statistical processes and thinking, and they believe that the Tandy Color Computer is an ideal machine for the reduction of data.

Sharpen your skills with **The Rainbow Introductory Guide to Statistics** for only \$6.95. Included in the book is the *CoCo-Stat* program, a BASIC statistics program just for the *Color Computer*. (80-column printer required.) Forget the typing hassle by ordering the accompanying **Statistics Tape or Disk** for only \$5.95. Spend your time learning and enjoying the new material, not debugging your typing. Just pop in the tape or disk and you're ready for action!

Save when you buy **The Rainbow Introductory Guide to Statistics** book together with the tape or disk. Get both for only \$11.95!

Please send me: The Rainbow Introductory Guide to Statistics Book \$6.95*
The Rainbow Introductory Guide to Statistics Tape or Disk \$5.95
The Rainbow Introductory Guide to Statistics Book/Disk Set \$11.95

Name _____

Address _____

City _____ State _____ ZIP _____

My check in the amount of _____ is enclosed*

Please charge to my: VISA MasterCard American Express

Acct. No. _____ Exp. Date _____

Signature _____

Mail to: The Rainbow Introductory Guide to Statistics, The Falsoft Building, P.O. Box 385, Prospect, KY 40059

To order by phone (credit card orders only), call (800) 847-0309, 8 a.m. to 5 p.m. EST. For other inquiries, call (502) 228-4492.

*Add \$1.50 per book for shipping and handling in the U.S. Outside the U.S. add \$4 per book (U.S. currency only). Kentucky residents add 5% sales tax. In order to hold down costs, we do not bill. Please allow 6-8 weeks for delivery.

Note: The tape and disk are not stand-alone products. If you buy either the tape or disk, you still need to purchase the book for instructions.

1010 DATA 59,130,51,113,48,233,5
3,237
1020 DATA 56,117,61,113,255,255,
255,255
1030 DATA 255,255,0,0,63,252,31,
244
1040 DATA 19,196,6,144,8,32,32,8
1050 DATA 32,8,8,32,6,144,0,0
1060 DATA 21,4,5,17,1,65,10,161
1070 DATA 42,168,170,170,42,168,
10,160
1080 DATA 1,64,0,0,2,128,255,255
1090 DATA 61,124,61,124,182,158,
189,126
1100 DATA 63,252,63,252,255,255,
4,16
1110 DATA 1,64,3,192,1,64,5,144
1120 DATA 86,165,85,84,21,80,5,6
4
1130 DATA 1,64,42,168,170,170,15
7,222
1140 DATA 42,168,10,160,255,255,
36,24
1150 DATA 36,24,36,24,255,255,16
0,10
1160 DATA 168,42,41,104,43,232,9
,96

1170 DATA 9,96,0,64,0,16,4,64
1180 DATA 1,0,5,80,31,244,7,253
1190 DATA 1,244,0,80,1,66,5,3
1200 DATA 1,65,1,69,0,85,4,16
1210 DATA 17,132,67,193,7,208,17
,68
1220 DATA 67,193,7,208,17,68,66,
33
1230 DATA 0,0,0,20,0,85,0,117
1240 DATA 0,85,21,85,172,213,170
,165
1250 DATA 187,20,21,80,5,64,168,
21
1260 DATA 8,17,40,80,32,64,131,2
34
1270 DATA 171,194,1,8,5,40,68,32
1280 DATA 84,42,2,0,3,40,11,188
1290 DATA 11,238,46,172,187,188,
175,166
1300 DATA 126,224,126,192,24,0,0
,4
1310 DATA 0,18,0,18,1,18,1,42
1320 DATA 17,168,18,128,26,0,168
,0
1330 DATA 160,0,255,255,255,255,
255,255

DATAMATCH, INC.

(THE SOFTWARE HOUSE HAS A NEW NAME)

DS/DD DISKS  **\$45/100**
10/\$4.95

FLIPPY DISKS **10/\$7.95**

FACTORY PUNCHED—USE BOTH SIDES. \$75/100
CERTIFIED ERROR FREE. W/SLEEVES, LABELS, W.P.

PRINTER RIBBONS

APPLE IMAGE WRITER	\$ 4.95	6/027.00
APPLE IM.WR.II 4 COLOR	\$12.95	
APPLE LG - M/S	\$ 4.95	
COMMODORE MPB 801	\$ 4.95	R.B. DMP110
COMMODORE MPB 803	\$ 4.95	
COMMODORE 1526	\$ 7.50	BLUE STREAK
DIABLO HYTYPE II - M/S	\$ 4.95	
EPSON MX80/86E	\$ 4.95	6/027.00
EPSON SPECTRUM LX80/90	\$ 4.50	
GENINI 10/8/80, BLACK	\$ 2.00	DOZ./022.00
GEN COLORS R-B-G-BR-PUR	\$ 3.00	5/012.00
NEC P2/P6 FILM	\$ 6.95	
NEC P3/P7 FILM	\$ 8.95	
OKIDATA 80/02/90/92 - SEE GENINI 10		
OKI.MICROLINE 102/192	\$ 7.50	
R.B. DMP130, BLACK	\$ 6.95	
COLORS RED-BLU-GREEN	\$ 7.95	3/022.00
STAR ML/NX/10, BLACK	\$ 7.95	
STAR RADIX 10, BLACK	\$ 7.00	
OTHER RIBBONS AVAILABLE. CALL OR WRITE.		

ALL ITEMS 100% GUARANTEED

Add \$2.50 S/H in U.S.A. - Canada Add \$3.50 + \$1.00/LB
Michigan Residents Add 4% Sales Tax
Send Check/Money Order Payable to:

DATAMATCH, INC.

9020 Hemingway, Redford, MI 48239
(313) 937-1313

Send Card Number & Exp. Date

Min. Charge Order \$20.00

**"I cannot imagine the CoCo 3 without ADOS-3;
it would not be a complete machine."**

The RAINBOW, July 1987

You've moved up to a CoCo 3. A powerful new machine. Now, it's time to give BASIC a shot in the arm, with ADOS-3. Wouldn't it be nice to turn on your machine and be greeted by an 80-column display, in the colors of your choice, with your own custom startup message? To run routinely at 2 MHz (double speed) without having to slow down for disk and printer operations? This and much, much more is possible with ADOS-3, our CoCo 3 adaptation of the acclaimed original ADOS, which shares the original's virtual 100% compatibility with commercial software. After customizing ADOS-3 using the provided configuring utility, you can have it burned into an EPROM that plugs into the Disk BASIC ROM socket, or just use it in RAM as a disk utility. (EPROM + burning will cost \$15-20; we provide information concerning how you can have this done.) Supports double-sided drives (35, 40, or 80 tracks). FAST and SLOW commands, auto line number prompts, RUNM command, keystroke macros, arrow-key scroll through BASIC programs, auto-edit of error line, and many more valuable features.

"ON A SCALE OF 1 TO 10, I RATE ADOS-3 A SOLID 15." RAINBOW, 7/87

Disk . . . \$34.95 Original ADOS for CoCo 1 or 2 . . . \$27.95 (See 6/87 RAINBOW review)

Original ADOS plus ADOS-3 . . . \$50.00

THE PEEPER

ML program tracer that multitasks with the target program. An excellent learning tool for the ML novice; an invaluable debugging aid for the expert. CoCo 1, 2, or 3 compatible.

Disk . . . \$23.95 Assembler source listing . . . Add \$3.00

MONITOR CABLES for CoCo 3

Magnavox 8CM515/8CM505/8CM643 . . . \$19.95 Sony KV4311CR . . . \$29.95

SPECTROSYSTEMS 

11111 N. Kendall Drive,
Suite A108
Miami, Florida 33176
(305) 274-3899 Day or Eve.

No delay on personal checks • Please add \$2.00 shipping • Sorry no credit cards or COD's.

NOVICES NICHE



THE RAINBOW is a teaching environment and we realize that the majority of our readers will always be beginners. In our continuing effort to always keep the new user in mind, and in addition to the many beginner feature articles and programs published in every issue, "Novices Niche" contains shorter BASIC program listings that entertain as well as help the new user gain expertise in all aspects of the Color Computer: graphics, music, games, utilities, education, programming, etc.

Game Utility

Seeking Immortality

By Paul Alger

16K
Disk

Do you have some older video games for your CoCo that you have never completed, or games with graphics screens you've never even seen before? Fear not, gamerster, for now your character will live long enough to reach the trail's end.

Immortality Finder is a game utility that will help you find the elusive "immortality poke" for most video games. This poke is the memory location that holds the number of "men" you start with on a given game. If you poke this location with, say, a value of 255, then you start off the game with 255 men!

Immortality Finder works on the principle that most machine language game programmers load the number of men using an LDA or LDB command when the game is initialized. *Immortality Finder* checks the ML code for all LDAs and LDBs. It then checks the value that is loaded into the A or B register. If the value is close to the number of men you start with, that location becomes a possible immortality poke.

It's easy to use the program. Just run and enter the filename and extension of the game you want to search. The program asks how many men the game starts with. Enter that number, insert the game disk and wait for *Immortality Finder* to complete the search. When the search is complete, you have the option to print the list of possible locations to the screen or to the printer. The list gives *all* of the possible immortality poke locations.

To test a poke, first load your game, poke the location with the number of men you want, and then EXEC. For example, if you run *Immortality Finder* on last month's *Tut's Tomb* (July 1988 RAINBOW, Page 58), you will get a printout of nine possible locations. The first is Location 6979. In this example, we type the following:

```
LOADM "TUT1.BIN"  
POKE 6979,255  
EXEC
```

After giving this poke a test run, we discover — lo and behold — that it works! In fact, it gives us 255 "men" instead of three. But if Location 6979 *didn't* work, we would run the process again for the next location on the list, which happens to be Location 7090. And on and on, until we found one that did work.

Immortality Finder will not work for all games, however. Game candidates must be in RS DOS, start with a specific number of men, and fit into memory with the *Immortality Finder* program. Here are some of the games I have found to work successfully with the program: *Shock Trooper*, *Crash*, *Ninja Warrior* and *Gold Runner*.

Remember, immortality comes at a price: Gamersters who partake of the waters of immortality should not submit their immortal scores to RAINBOW's Scoreboard.

The listing: IMMORTAL

```
Ø GOTO9Ø  
5 CLEAR2ØØ, &H2ØØØ:DIMA(5Ø), B(5Ø)  
:CLS:PRINT"IMORTALITY FINDER":PR  
INT"BY PAUL ALGER":PRINT  
1Ø PRINT"ENTER FILENAME/EXT: ";:  
LINEINPUTFI$:INPUT"HOW MANY MEN  
DO YOU START WITH";C1:PRINT"INSE  
RT DISK WITH "FI$" AND HIT ENTER  
. ";:LINEINPUTZ$  
15 OPEN"D", #1, FI$, 1:IF LOF(1)=Ø  
THEN CLOSE:KILL FI$:RUN  
2Ø FIELD#1, 1 AS A$:B=LOF(1):FORQ  
=1TO5:GET#1, Q:C(Q)=ASC(A$):NEXTQ  
:CLOSE:ST=(C(4)*256+C(5)):LG=(C(  
2)*256+C(3)):ED=ST+LG:OF=&H2ØØØ-  
ST:IF OF<1THENOF=Ø  
25 IF OF+ED>&H8ØØØ THENPRINT"WHE
```



```

N IO ERROR OCCURS, TYPE:" :PRINT"
GOTO35
30 LOADMFI$,OF
35 CLS(3):PRINT@5,"FILENAME:";:P
RINT@16,FI$;
40 PRINT@66,"START";:PRINT@73,US
ING"#####";ST;:PRINT@66+64,"END
";:PRINT@73+64,USING"#####";ED;
:PRINT@66+32,"NOW ";:PRINT@73+3
2,USING"#####";M;
45 PRINT@81,"LDA'S ";:PRINT@89,U
SING"#####";LA;:PRINT@81+32,"LDB'
S ";:PRINT@89+32,USING"#####";LB;
:PRINT@81+64,"POKES ";:PRINT@89+
64,USING"#####";0;
50 FOR M=ST+OF TO ED+OF
55 FORM=ST+OF TO ED+OF:PRINT@105
,USING"#####";M-OF;
60 IF PEEK(M)=&H86 THEN LA=LA+1:
PRINT@89,USING"#####";LA;:IF PEEK
(M+1)=C1 OR PEEK(M+1)=C1+1 THEN L

```

```

=L+1:A(L)=M-OF:PRINT@153,USING"#
###";L+L1;
65 IF PEEK(M)=&HC6 THEN LB=LB+1:
PRINT@121,USING"#####";LB;:IF PEE
K(M+1)=C1 OR PEEK(M)=C1+1 THEN L
1=L1+1:B(L1)=M-OF:PRINT@153,USIN
G"#####";L+L1;
70 NEXT:PRINT@321," ";:INPUT"DON
E... HIT ENTER TO PRINT";Z$
75 CLS:PRINT"PRINT TO [S]CREEN O
R [P]RINTER.":PRINT"(ENTER P OR
S) ";:LINEINPUTZ$:IFZ$="P"THEND=
2ELSE=0
80 PRINT#-D,"FILENAME: ";FI$:PRI
NT#-D,"DECIMAL","HEX":FORX=1TOL:
PRINT#-D,A(X)+1,HEX$(A(X)+1):NEX
T:FORX=1TOLL1:PRINT#-D,B(X)+1,HEX
$(B(X)+1):NEXT
85 PRINT"HIT ENTER TO PRINT AGAI
N.":LINEINPUTZ$:GOTO75
90 PCLEAR1:GOTO5

```

Arcade

Minding Your X's and Y's

By James Kevin Lowry

16K
ECB

You have two eyes, so you'd think you'd be able to see two things at once. Frogs can, sort of. With *JoyZap*, you had better train your eyes to be ambidextrous or be very quick.

JoyZap is a shoot-'em-up with a twist — you don't aim at your target using a "hairline" cursor; you use *guides*, points on the *x*- and *y*-axes. When you boot up *JoyZap*, the two axes are drawn and the space they enclose begins to fill randomly with blocks. Your joystick position is tracked on the axes, and your mission is to lock on to the points that define a target and press the firebutton. Red blocks are worth 20 points; blue, 10; white, 5. Be careful: If you don't hit the block squarely, hitting an adjacent space instead, the block will become green and worth only one point.

Delete Line 40 if your computer cannot handle the high-speed poke.

The listing: JOYZAP

```

10 CLS:PRINT@172,"JOYZAP":PRINT@
480,"COPYRIGHT 1987 JKL JAMES K
LOWRY":FOR Z=1 TO 1500:NEXTZ
40 POKE 65495,0
50 CLS(0)
60 S=0:SC=0
70 PRINT@480,"HITS="S" SCORE="S
C;
80 FOR B=0 TO 63:SET(B,0,3):NEXT
90 FOR C=0 TO 27:SET(0,C,3):NEXT
100 TIMER=0

```

```

110 Z=RND(20):IF Z=10 THEN SET(R
ND(50)+7,RND(12)+7,RND(3)+5)
120 X=JOYSTK(0):Y=JOYSTK(1)
130 IF X<2 THENX=2
140 IF Y<2 THEN Y=2
150 IF Y>27 THEN Y=27
160 SET (X,2,5):SET(2,Y,5)
170 RESET(X,2):RESET(2,Y)
180 IF TIMER>7000 THEN GOTO 280
190 IF BUTTON(0)=1 THEN GOTO 200
ELSE GOTO 110
200 H=POINT(X,Y):IF H=6 THEN GOT
O 230 ELSE IF H=7 THEN GOTO 240
ELSE IF H=8 THEN GOTO 250 ELSE I
F H=1 THEN GOTO 260
210 SET(X,Y,1):SOUND 40,5::RESET
(X,Y)
220 GOTO 110
230 GOSUB 270:S=S+1:SC=SC+5:RESE
T(X,Y):PRINT@480,"HITS="S" SCORE
="SC;:GOTO 110
240 GOSUB 270:S=S+1:SC=SC+10:RES
ET(X,Y):PRINT@480,"HITS="S" SCOR
E="SC;:GOTO 110
250 GOSUB 270:S=S+1:SC=SC+20:RES
ET(X,Y):PRINT@480,"HITS="S" SCOR
E="SC;:GOTO 110
260 GOSUB 270:S=S+1:SC=SC+1:RESE
T(X,Y):PRINT@480,"HITS="S" SCORE
="SC;:GOTO 110
270 SOUND200,2:SOUND185,4:RETURN
280 POKE65494,0
290 PRINT"AVERAGE="INT(SC/S):END

```

Space Attack

CoCo 3

By John T. Wells

To me, the most interesting type of game for home computers has always been the space shoot-'em-up. I wrote *EZShoot* to illustrate how easy it is to write and develop such a program.

In *EZShoot* you control a cannon's movement at the base of the screen with the left and right arrow keys. Using the space bar as a trigger, you shoot at spacecraft that fly above. For each direct hit, you score 10 points. The craft crosses the screen in uneven distance and timing spurts, so staying in one place and firing won't result in hits every time.

The listing: EZSHOOT

```
1 POKE65497,0:ON BRK GOTO 17
2 HSCREEN2:HBUFF1,1900:HBUFF2,19
  00:HBUFF3,1900:HCLS(8):HDRAW"C6;
  BM100,50;R10F5R5D2L5G5L10E6H6":H
  PAINT(110,55),6,6:HGET(100,50)-(
  145,85),1:HDRAW"C7;BM200,100;D4R
  3D4L5U4R3U4":HPAINT(201,105),7,7
  :HGET(190,90)-(235,125),2
3 SO$="T255;12;11":S1$="T255;02;
  12;11"
4 HCLS8
5 FOR T=1TO2000
6 HGET(100,100)-(150,140),3
7 X1=160:Y1=170:Y2=30:SC=0
8 FOR C1=1 TO 20:F1=3
```

```
9 RD=RND(30):IF RD<15 THEN 9 ELS
  E FOR X2=30 TO 270 STEP RD:HPUT(
  X2,Y2)-(X2+44,Y2+28),1,PSET
  10 II$=INKEY$:IF II$="" THEN II=
  10 ELSEIF II$=" " THEN GOSUB 18
  ELSE II=ASC(II$)
11 HPUT(X1,Y1)-(X1+50,Y1+40),3,P
  SET
12 IF II=8 THEN X1=X1-16 ELSEIF
  II=9 THEN X1=X1+16
13 HPUT(X1,Y1)-(X1+45,Y1+35),2,P
  SET
14 HPUT(X2,Y2)-(X2+50,Y2+40),3,P
  SET
15 NEXT X2
16 NEXT C1
17 HPRINT(10,15),"AGAIN (Y/N) <E
  NTER>? ":LINE INPUT AN$:IF AN$="
  Y" THEN 4 ELSE POKE65496,0:END
18 F1=F1-1:IF F1<0 THEN RETURN E
  LSE PLAY SO$:FOR YY=Y1-10 TO Y2
  STEP -30:HSET(X1+10,YY,1):IF HPO
  INT(X1+9,YY)=6 OR HPOINT(X1+11,Y
  Y)=6 THEN GOSUB20 ELSE HSET(X1+1
  0,YY,8):NEXT
19 RETURN
20 HCIRCLE(X1+15,YY-2),10,7:HPAI
  NT(X1+10,YY),7,7:FOR CT=1 TO 10:
  PLAYS1$:NEXT:HPUT(X1-20,YY-20)-(
  X1+30,YY+20),3,PSET:SC=SC+10:HPR
  INT(10,1),"SCORE":HCOLOR8,8:HPRI
  NT(20,1),SC-10:HCOLOR7,8:HPRINT(
  20,1),SC:RETURN
```

Simulation

Winging It

CoCo 3

By Chad Presley

Who would have thought that a CoCo 3 could take flight in so few lines of BASIC coding? Well, with this little flight simulator you can't do dogfights and you can't drop bombs, but you can experience the illusion that you are actually in the cockpit of a plane, diving and turning. Just plug in your right joystick and take to the air.

The listing: FLIGHT

```
10 ONBRKGOTO190
20 REM HI-RES FLIGHT SIMULATOR
30 REM BY CHAD PRESLEY
40 POKE65497,0:A=87:B=87
50 HSCREEN2:HCLS14:HCOLOR3
```

```
55 HCOLOR0:HLINE(0,10+A)-(320,10
  +B),PSET:HPAINT(0,100),0
```



```

6Ø HCOLOR1:HPRINT(8,Ø), "HI-RES F
LIGHT SIMULATOR":HPRINT(12,1), "B
Y CHAD PRESLEY":HCOLOR8:HLINE(Ø,
25)-(32Ø,25), PSET
7Ø H=JOYSTK(Ø):V=JOYSTK(1)
8Ø IFA=15THENA=A+1ELSEIFA=17ØTHE
NA=A-1
9Ø IFB=15THENB=B+1ELSEIFB=17ØTHE
NB=B-1
1ØØ IFH>43THENA=A-1
11Ø IFH<23THENA=A+1

```

```

12Ø IFV>43THENB=B+1
13Ø IFV<23THENB=B-1
14Ø HCOLORØ:HLINE(Ø,1Ø+A)-(32Ø,1
Ø+B), PSET
15Ø HCOLOR8:HLINE(Ø,9+A)-(32Ø,9+
B), PSET
16Ø HLINE(Ø,6+A)-(32Ø,6+B), PSET
17Ø HCOLOR4:HDRAW"BM17Ø,96;L2Ø;R
1Ø;U5":HCIRCLE(16Ø,96),3
18Ø SOUNDA+B/2,1:GOTO7Ø
19Ø POKE65496,Ø:END

```

Mind Game

4K

What's Missing?

By Keiran Kenny

You never miss something until it's gone, the saying goes. With this game you'll find it's hard to *remember* something when it's gone.

This program allows you to test and train your memory. After you have given the program a difficulty level as prompted (a range from two to 10), the screen displays rows of random letters, which you must study until you think you have them memorized. Then test yourself by pressing any key. One of the rows will disappear, and you will be asked to type in what you think it was. The computer will tell you if you are right or wrong and will keep track of your score.

The listing: MEMORY

```

1Ø CLS:GOTO3Ø
2Ø K$=INKEY$:IFK$=""THEN2ØELSERE
TURN
3Ø PRINT@4Ø,"<<<MEMORY>>>"
4Ø PRINT@96,"BY KEIRAN KENNY, TH
E HAGUE, 1987"
5Ø PRINT@192,"SET DIFFICIULTY LE
VEL:"
6Ø PRINT@26Ø,"";:INPUT"NO. OF RO
WS (2-1Ø):";NR
7Ø IFNR<2ORNR>1ØTHENPRINT@256,""
:GOTO6Ø
8Ø PRINT@324,"";:INPUT"NO. OF LE
TTERS (2-6):";NL
9Ø IFNL<2ORNL>6THENPRINT@324,"":
GOTO8Ø
1ØØ PRINT:PRINTTAB(6)"PRESS ANY
KEY.":GOSUB2Ø
11Ø CLS
12Ø P=34
13Ø FORN=1TONR
14Ø FORT=1TONL
15Ø R=64+RND(26)
16Ø A$=CHR$(R)

```

```

17Ø PRINT@P,A$;
18Ø B$=B$+A$
19Ø P=P+1
2ØØ NEXT
21Ø C$(N)=B$:B$=""
22Ø P=P+32-NL
23Ø NEXT
24Ø PL=PL+NR*NL
25Ø K$=INKEY$
26Ø P=32:PP=P*(NR+2)+2
27Ø PRINT@PP,"WHEN READY, PRESS
ANY KEY.":GOSUB2Ø
28Ø N=RND(NR)
29Ø IP=P*N:PRINT@IP,""
3ØØ PRINT@PP,"<ENTER> THE MISSIN
G ROW."
31Ø PRINT@IP,"";:INPUTD$
32Ø PRINT@IP+NL+3,"";:IFD$=C$(N)
THENPRINT"RIGHT!":RT=RT+NR*NL EL
SEPRINT"WRONG! IT WAS "CHR$(34)C
$(N)CHR$(34)
33Ø PRINT@PP,"SCORE:"RT;CHR$(8)"
! POSSIBLE:"PL;CHR$(8)".
34Ø SC=SC+1:IFSC/5=INT(SC/5)THEN
PRINT@PP+64,"CHANGE DIFFICULTY L
EVEL? Y/N"ELSE39Ø
35Ø GOSUB2Ø
36Ø IFK$="Y"THENCLS:GOTO5Ø
37Ø IFK$="N"THENCLS:GOTO12Ø
38Ø GOTO35Ø
39Ø PRINT@PP+7Ø,"PRESS ANY KEY."
:GOSUB2Ø
4ØØ CLS:GOTO12Ø

```

Submissions to "Novices Niche" are welcome from everyone. We like to run a variety of short programs that can be typed in at one sitting and are useful, educational and fun. Keep in mind, although the short programs are limited in scope, many novice programmers find it enjoyable and quite educational to improve the software written by others.

Program submissions must be on tape or disk. We're sorry, but we cannot key in program listings. All programs should be supported by some editorial commentary, explaining how the program works. If your submission is accepted for publication, the payment rate will be established and agreed upon prior to publication.



Delivering newspapers and fliers for local stores is a popular way of earning money for many preteens and teen-agers in our area. They opt for this kind of job because it allows them to work close to their homes, and also affords them the opportunity to be "their own boss." One of the essentials these junior entrepreneurs soon discover is that it is vital to keep good records on their customers. This month's article presents a portion of a collection chart teens could use for their newspaper delivery routes.

Newspaper carriers ordinarily prepay for their newspapers. Of course, they pay a lower price than the one printed on the newspaper. Money is made both from tips and the difference in the amount that carriers pay and later receive for the newspapers. We are concerned with figuring out how to read such a chart and to determine how much money to collect.

There are only eight names on our sample collection list. (We would hope this represents only a small portion of a carrier's true list.) When using DATA statements of less than 10 elements, it is unnecessary to use a DIM statement. Line 40 is therefore able to read in the eight customer names, which are contained in the one DATA statement in Line 280. Line 80 prints these names on the screen. You can alter these to more creative or meaningful names in your program.

Line 50 asks for user input. The student may select a real or imaginary price for the newspaper. This becomes Variable W. Arbitrarily we decide to double the daily price to create a Sunday edition price, which becomes Variable SU.

We feel that this user input feature is a key element to the program; it can be used in various ways. You could insist that students select realistic prices, which could lead to a social studies discussion of newspaper pricing. For example, the 5-cent newspaper of my youth now costs 35 cents. On the other hand, you could encourage unrealistic

Steve Blyn teaches both exceptional and gifted children, holds two master's degrees and has won awards for the design of programs to aid the handicapped. He owns Computer Island and lives in Staten Island, New York.

Interpreting a newspaper delivery chart

Carrier's Collection Chart

By Steve Blyn
Rainbow Contributing Editor

price selections to create a greater variety of possible arithmetic examples.

Not all customers order the newspaper every day of the week. Some want delivery only on the weekdays, and some may want only the weekend editions or just the Sunday paper. Lines 100 through 140 offer five different sequences of delivery days customers may have to choose from. A plus sign indicates that the paper is ordered on that day. The delivery schedule for each customer is chosen randomly each time the program is run. This helps create

interest and eliminates memorization.

The student's task is to compute the amount each customer owes him for the week. The correct answer is represented by Variable TT; the user's answer is represented by Variable Q. Line 200 asks the student to input an answer. Lines 210 through 230 then compare the two answers and inform the student whether or not the answer is correct.

After each example, the student presses ENTER to go on to the next example. After each set of eight, the student should press either the E key to end the program or the ENTER key to begin again.

Line 240 always prints the correct answer on the chart, whether or not it was answered correctly. You might care to examine the chart with the student at the end of each set of eight examples. You might, for example, ask which customer owes the most or the least amount of money. Perhaps you might ask for the total of the eight customers. Another idea is to make up a price paid for the papers vs. the price collected to determine the profit. Including imaginary tips would be even more realistic. These are only a few of the ideas that may evolve from the information printed on the screen during the course of the program.

As usual, we encourage you to modify our programs for use in the ways that best suit your child's or student's needs. We, at Computer Island, always enjoy hearing from our readers. □

The listing: NEWSCOST

```

10 REM NEWSPAPER DELIVERY ROUTE
20 REM STEVE BLYN, COMPUTER ISLAN
D, STATEN ISLAND, NY, 1988
30 CLEAR 10000: P$=STRING$(32,131)
:CLS
40 FOR T= 1 TO 8:READ A$(T):NEXT
T
50 PRINT"HOW MANY CENTS IS A DAI
LY NEWSPAPER THIS WEEK";:I
NPUT W:SU=W*2
60 CLS:PRINT@0,"SALES: DAILY=";W
;" SUNDAY=";SU
70 PRINT@32,P$;
80 FOR T=1 TO 8:PRINT@128+M,A$(T
):M=M+32:NEXT T
90 IF X=256 THEN RUN ELSE R=RND(
5):PRINT@384,STRING$(126," ");
100 IF R=1 THEN B$="+ + + + +
+":TT=6*W+SU

```



```

110 IF R=2 THEN B$="+ + + + + +
:TT=6*W
120 IF R=3 THEN B$="+ + + + +":T
T=5*W
130 IF R=4 THEN B$="          +
+":TT=W+SU
140 IF R=5 THEN B$="+ + +
+":TT=3*W+SU
150 PRINT@64,"NAME          M/T/W/T
/F/S/SU=TOTAL"
160 PRINT@96,P$;
170 PRINT@384,P$;
180 TT=(TT/100)
190 PRINT@139+X,B$;
200 PRINT@416,"WHAT IS THE TOTAL
? $";:LINEINPUT Q$
210 Q=VAL(Q$):X=X+32
220 IF INT(Q*(100+.05))=INT(TT*(
100+.05)) THEN PRINT@460,"CORREC
T":SOUND 220,2:GOTO 240
230 PRINT@448,"SORRY, THE ANSWER
IS ";:PRINT USING"$#.##";TT
240 PRINT@153+X-32,"";:PRINT USI
NG"$#.##";TT
250 PRINT@485,"PRESS ENTER TO GO
ON";
260 EN$=INKEY$
270 IF EN$=CHR$(13) THEN 90 ELSE
IF EN$="E" THEN 290 ELSE 260
280 DATA JONES,SMITH,MARTIN,ROSS
,PEARL,BELL,SCOTT,GOLD
290 CLS:END

```

Two-Liner Contest Winner . . .

A classic pong-type game for two players, with an added obstacle in the center. Use the joysticks to keep the ball in play. For super-pro speed, use a speed-up poke.

The listing:



```

0 READF,G,T,O,C,D,A,B,N,S(1),S(3
),O(1),O(3):PMODEL:PCLS:LINE(0,0
)-(T,O),PSET,B:COLOR2:SCREEN1:FO
RI=1TON:FORJ=0TO3:E(J)=JOYSTK(J)
:NEXT:FORJ=1TO3STEP2:E=E(J)*2.58
+2:IFE<>O(J)THENLINE(S(J),O(J))-
(S(J),O(J)+25),PSET:LINE(S(J),
E)-(S(J),E+25),PSET
1 O(J)=E:NEXT:PSET(A,B,H):A=A+C:
B=B+D:H=PPOINT(A,B):IFH=2THENPLA
Y"T40G":POKE65495,0:C=-C:NEXTELS
EIFH=4THENPLAY"T40G":D=-D:NEXTEL
SEIFA<10THENSOUND100,9:RUNELSEIF
A>245THENSOUND100,9:RUNELSEPSET(
A,B,2):NEXT:DATA1,1,255,191,8,8,
128,96,9999,232,24,5,5

```

Michael Toepke
Oak Harbor, WA

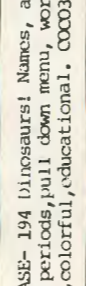
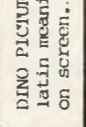
(For this winning two-liner contest entry, the author has been sent copies of both *The Third Rainbow Book of Adventures* and its companion *The Third Rainbow Adventures Tape*.)

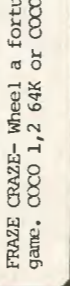
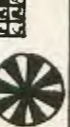
	<p>DINO PICTURE DATA BASE- 194 Dinosaurs! Names, arcs, latin meanings, time periods, pull down menu, world map on screen. Powerful, colorful, educational. COCO3 29.95</p>
	<p>Build your own coin-operated Video Game using the COCO! Complete instruction book with plans, schematics, parts sources. All software provided and includes a 4 in 1 video game that you can use. COCO 1 and 2. DISK 29.95</p>
	<p>Autoboot your computer- This hardware project will RUN a program as soon as the COCO is turned on, without you having to touch the keyboard! Schematics and instructions only 9.95 COCO1 and 2. Will work on most switch matrix type computers.</p>
	<p>FRAZE CRAZE- Wheel a fortune with this popular word game. COCO 1,2 64K or COCO3. 14.95 DISK</p>
	<p>THE MEMORY GAME- Flip a card and see if you can find its match. With basic shapes for younger players, all the way up to intricate shapes for those with CONCENTRATING minds. A beautiful family game! COCO3, Joystick, Disk 19.95</p>
	<p>Why go to RENO? Now you can enjoy the excitement of a Casino style game with BIG CITY KENO! A big winner on the COCO3. Disk, 19.95</p>
<p>CHECK, MONEY ORDER OR C.O.D. IN U.S. FUNDS TO RAM ELECTRONICS 814 JOSEPHINE, MONMOUTH, OREGON PHONE NUMBER 503-838-0139</p>	

DON'T JUST DUMP YOUR "PMODE4", "PMODE3" GRAPHICS...

Expand, shrink & stretch 'em with ZOOMDUMP

ZOOMDUMP requires an ext. BASIC CoCo & DMP-105 or compatible printer. Print out "PMODE4" or "PMODE3" graphics screens to within a fraction of an inch of any height or width you specify -- up to 7.8" wide, in normal or negative image. MAKE YOUR GRAPHICS DUMPS FIT THE JOB -- NOT VICE VERSA!

Specify tape or disk. Send check or money order for \$14.00* to:

CODIS ENTERPRISES
2301-C Central Dr., Ste. 684
Bedford, TX 76021

Sample printouts available upon request if return postage provided.

*Texas residents add 7% sales tax.



Throughout my adult life I've hummed to my tone-deaf self, "Once in the dear, dead days beyond recall/When on the earth the mists began to fall." This scrap of verse was all I remembered of that old song, but it stuck in my mind like glue.

Back in the dim '30s when I was struggling through the Big Apple's P.S. 82, during a rudimentary music appreciation class an old Irishman came to teach us a song he had composed. I was impressed because he was a composer; no VIPs ever came within the purview of our self-contained ethnic neighborhoods, and nobody at all ventured to bother with grimy, runny-nosed kids.

You must wonder what this has to do with THE RAINBOW!

A friend of mine who had recently bought an expensive electronic organ had gone up North for the Christmas holidays. Left to my own devices, I wondered if there were any music programs that might be of value to her and help her comprehend music theory, etc. I checked out my personal hoard of programs but found it wanting.

What do you do when you want to find a program suitable for your needs? Silly question — you consult the back issues of THE RAINBOW! Everybody knows that June is the Music Issue of THE RAINBOW, so that's where I headed.

I looked through the June '87 issue to see what I could find. I noticed some articles referring to a *Music+* program. I filed that information away in my mind, took down all my June issues from '83 onward and leafed through them.

A chord identification program in the June '84 issue caught my eye, and I duly copied the listing. Hungry for more *music theory* material, I reverted to the June '87 issue and copied a program that allows you to play the CoCo as a two-level organ. From the '86 issue, I pulled another goodie.

In doing all this *pro bono* work I began to generate some interest of my own in what the programs promised . . . and did.

Repairing to the June '87 issue, I read most of the articles. There was a tempting musical synthesizer program, but

*Wondering what to do
with that stack of
RAINBOW back issues?*

The "Encyclopedia CoColoria"

By Joseph Kolar
Rainbow Contributing Editor

the listing appeared daunting; even though it promised four-voice harmony, I was chicken.

Joseph D. Platt's article intrigued me. It offered transposition refinements for *Music+*. Naturally, it meant nothing to me, but in his article he referred to Bill Ludlum's *Music+* program in the Music issues of '84 and '86. Back to the June '86 issue! Bob Ludlum's article had to do with improvements to his *Music+* program. Back further to the June '84 issue! In this article Ludlum wasted no time listing the forerunners of his program; he referred to the December '83 issue as the immediate basis of *Music+* and urged readers to refer to Larry Konecky's *CoCo Composing* program.

Do you begin to see how useful RAINBOW's back issues are to a CoCo owner? Think of all the material at hand that will never get stale. Since your interests may change or expand, back issues and the yearly index of articles in July's Anniversary Issue is a readily available pool of information.

Tracking down *Music+* led me to the June '84 issue for good. I compared it with Larry's program in the December '83 issue and found it so tempting that I keyed it in. What satisfaction! It allowed me, a tone-deaf, musical-instrumentless klutz to copy and create music. Following the rule that nothing breeds success like success, I returned to

the '86 Music Issue and copied what refinements were listed. Then off to the '87 Music Issue to incorporate Joseph Platt's enhancements to the *Music+* program.

This musical odyssey was really getting me hooked. Here I was, with no musical instrument, copying a music score and creating creditable music in four-voice harmony. I couldn't get over it! As I played some of my home-grown selections, I kept looking around for the orchestra.

Without the back issues of THE RAINBOW I would not have been able to accomplish this feat.

That music synthesizer program was luring me onward. Even though I had a perfectly good four-voice program, I decided to copy the listing offered by Matthew Thompson in the June '87 issue (Page 58). This program, titled *Bells and Whistles 2*, was claimed by its author to be "one of the best-sounding all-software music synthesizers for the CoCo" in the entire world as of December, 1986. It was a toughie to copy, and then I couldn't get it to work properly.

Persistently I looked through a few issues after June's, just in case there were corrections to the program; none were offered. OK, then it must be my error. Here's another valuable use of the back issues: I usually wait a few months before I attempt to copy a listing to make sure no corrections are necessary.

I checked the program over and over again, character by character, and that gets mind-boggling; still, I had a self-made error extant that I had to find. And one evening, I did find it; in the machine language section, I had copied "36" instead of "E6." This solved the problem and *voila*, I was in business.

I love this program and the world it has opened for me. The *Bells and Whistles 2* program, by a then 16-year-old, does what it claims. The text accompanying the article has no fluff or space-fillers; every sentence means something, and if you skip a line valuable information is overlooked.

As good as the program is, I am sure in June '89 or some following year, improvements will be made and offered in THE RAINBOW. Someday these future issues will be back issues and will contain valuable material. If that article in the hypothetical future issue intrigues your curiosity and you have saved all

your back issues, you will be able to refer diligently to whatever titillates your fancy at that moment.

I have noticed that it is possible to change the Envelope/Waveform setting in the four voices by locating the cursor over the proper voice in the E/W column and using the octal number to replace the old data. For instance, if you type 24 in the desired voice, 3,0 will result. 24 is equal to octal 30, or in this case Envelope 3, Waveform 0. I found this to be very convenient when experimenting with various sounds to get the right mix for a particular song.

We CoCo users have little opportunity to use octal code, but here is one time it becomes useful. Simply rule out several columns and lines, marking the top line and the first column 0 through 7. Then fill in the boxes horizontally from 0 through 63. The information inside is equivalent to the vertical scale augmented by the horizontal scale. Thus to get Voice 1,1: Plot the vertical 1, then the horizontal 1; where they cross you find the value 9, which calls octal 11 or 1,1.

One oddity I spotted is that although at any given instance you can have no more than eight envelopes and eight waveforms, you can get some dissonant but curious effects. You would think that 63, which translates to octal 77, would be the highest value you could type in. You can, however, type in a value up to 255, even though the resultant value shown in the E/W column is kind of weird. You might get a character other than a numeral or letter as the E value. Thus, you might get :4 or B2 or 90 — obviously typing errors. Still, odd sounds are created. If only one voice has this pseudo-value, the resultant four-voice harmony might be acceptable if odd sounds are your game. This is beyond my talent, but somebody might investigate this anomaly.

At any rate this program allows you to create all kinds of sounds. Practice in copying sheet music is one great self-teaching aide. In short order, you learn to read music. Then you begin to understand time, tempo and volume mixing. Then you begin to learn what notes to discard when more than four are listed in a location. And the first thing you know, you're looking for eight-voice harmony. This leads to special software and hardware — to get mired deeper and deeper in this musical quicksand. Then you get to wondering about MIDI, a whole new ballgame. (See the MIDI tutorial by John E. Mueller in the June '87 RAINBOW, Page 36).

Bells and Whistles 2 is a great aide in teaching newcomers to music what the correct beat should be and what the song should sound like. All this flirting with music has me so enthusiastic that I have bought an organ keyboard with MIDI capabilities. Someday I will get into MIDI; but right now with the help of Matthew Thompson's super program, I have to learn to play the keyboard.

“You will find that your interests expand or change with time; programs that you ignore as useless today, you may seek eagerly at a future date.”

Recently, I went to the library to rustle up some music to copy using my new tool. I came across a 1930-vintage songbook, and lo and behold! I found the song that had been rattling around in my brain all these years. It was “Love's Old Sweet Song” by J. L. Molloy. As soon as I keyed in the first few bars and ran it, a little part of my youth returned. I wonder what Mr. Molloy would say if he were around to hear me play his song just the way he wrote it, without a musical instrument? If I could go back to that classroom knowing what I know now, how could I explain to Mr. Molloy that a good 50 years later, without any musical training or inclination, I would be playing his song, in four voices, on a computer? How could I explain the CoCo without his calling the looney bin to have me carted away as a raving maniac?

Squirreling away all your copies of THE RAINBOW is one of the wisest actions you can take. If you are a relative newcomer to CoColand, you should make it a point to buy all the back issues that pertain to your personal fields of interest. Fortunately, it is no problem to determine which months you require. The annual anniversary issues contain the index for the year's cornucopia of

programs. It is an expensive outlay to get all the issues, so work backwards and get the more recent ones you lack. Add them to your reference library. You will find that your interests expand or change with time; programs that you ignore as useless today, you may seek eagerly at a future date.

Let me give you an example. I was never much interested in disk programs, mainly because I didn't own a disk drive. But when I finally did get one, suddenly I wanted a good program for business files. Guess where I found a premier program? In THE RAINBOW! Beginning with the July '84 issue (“Database Delight,” Page 64), a six-part database tutorial by Bill Nolan taught me the rudiments of developing a database manager program. I had doubted the possibility of finding a suitable program, and here were six tutorials lying on my shelves! Though dated in time, they are just as useful today as in the summer of '84 when I flipped past them without a second glance.

How much are all these back issues worth? To me, they are equivalent to an “Encyclopedia CoColoria.” Priceless information is available upon demand.

As more and more of the back issues become unavailable, all the wisdom contained therein will be lost to you. So, the corollary is: Don't let your subscription lapse. I have talked to CoCo owners who sadly state that they have dropped THE RAINBOW — incredible to me, because as CoCo owners they put themselves at a severe disadvantage without the wealth of information stored in the magazine. They may have saved a few bucks, but they are the poorer for it.

You old CoCo veterans who have read my articles since December '82 must have heard all this before. Still, the cheapest, most valuable reference tool is in your hands at this moment. Never, never throw away any issue — you'll be sorry!

Beginning next month I'll be presenting a series of 20 articles devoted to graphics. This material was written for the granddaddy CoCo, but it is just as valid today on CoCos 2 and 3. The articles could make a good-sized book of tutorials. You may find them valuable at some time in the future — when they will be buried in back issues!

I hope you haven't minded this month's absence of listings. If you keep in mind the message I've presented instead, you will have been well served. ☺

RAINBOW

Give us your best: Join the ranks of these courageous CoCoists in showing the Color Computer world your high score at your favorite micro-diversion. We want to put your best effort on record in THE RAINBOW's "Scoreboard" column. All entries must be received 60 days prior to publication. Entries should be printed — legibly — and must include your full name, address, game title, company name and, of course, your high score. Each individual is limited to three score entries per month. Send your entries to Scoreboard, c/o THE RAINBOW.

For greater convenience, your high scores may also be sent to us through the MAIL section of our Delphi CoCo SIG. From the CoCo SIG> prompt, pick MAIL, then type SEND and address to: EDITORS.

★ Current Record Holder ● Shutout

ADVANCED STAR*TRENCH (THE RAINBOW, 7/86)	89,285	Upton Thomas, Arnold, MD	Saskatchewan
4,750 ★Stephane Martel, Laval, Quebec	72,410	Glenn Hodgson, Aberdeenshire, Scotland	11,250 Stephane Martel, Laval, Quebec
4,475 David Schaller, Clarkston, WA			5,680 Kathy Rumpel, Arcadia, WI
4,500 Frankie DiGiovanni, Olney, MD	67,760	Jim Davis, Sandwich, IL	3,760 Rick Beavers, Bloomfield, MN
4,300 Jeffrey Warren, Waynesville, NC	DESERT PATROL (Arcade Animation)		3,505 Blake Cadmus, Reading, PA
3,960 Maurice MacGarvey, Dawson Creek, British Columbia	234,300 ★Steven Turcotte, Matane, Quebec		GALACTIC ATTACK (Radio Shack)
ASTRO BLAST (Mark Data)	DESERT RIDER (Radio Shack)		31,100 ★Upton Thomas, Arnold, MD
48,825 ★Tony Bacon, Mt. Vernon, IN	80,703 ★Thomas Payton, Anderson, SC		29,030 David Czarnecki, Northhampton, MA
BEE ZAPPER (THE RAINBOW, 9/87)	85,351 Jason Hackley, Clinton, CT		26,370 Jeff Remick, Warren, MI
15,785 ★David Hartmann, Osoyoos, British Columbia	64,789 Roby Janssen, Clear Lake, IA		22,250 Dave Staub, Moundsville, WV
	63,014 Rebecca Henderson, Ballston Spa, NY		11,830 Sheldon Pennay, Green Bay, Newfoundland
12,825 Frederick Lajoie, Nova Scotia, Canada	62,702 William Currie, Bryans Road, MD		GALAGON (Spectral Associates)
12,350 Tom Carpenter, Palenville, NY	50,797 Patrick Devitt, Lombard, IL		751,020 ★Sofia Giorgi, Brasilia, Brazil
12,175 Sara Mittelstaedt, Kiel, WI	47,677 Thomas Beall, Odenton, MD		357,890 Jason Clough, Houston, TX
11,675 Daniel Hartmann, Osoyoos, British Columbia	33,498 Brian Anderson, Clear Lake, IA		328,820 Bernard Burke, Lee's Summit, MO
	DEVIL ASSAULT (Tom Mix)		249,960 Matthew Fumich, Munford, TN
11,075 John Valentine, Marlborough, CT	1,866,100 ★Stephane Martel, Laval, Quebec		169,410 Danny Dunne, Pittsfield, NH
10,850 Matthew Yarrow, Easthampton, MA	623,550 Dale Krueger, Maple Ridge, British Columbia		GANTELET (Diecom Products)
10,700 Kevin Pereira, Corsicana, TX	75,000 Blake Cadmus, Reading, PA		45,235,820 ★Ken Hubbard, Madison, WI
BOUNCING BOULDERS (Diecom Products)	40,800 Benoit Landry, Drummondville, Quebec		23,643,720 Geran Stalker, Rowland, GA
10,930 ★Patrick Garneau, Ste-Croix, Quebec	DONPAN (Radio Shack)		20,921,490 Randall Edwards, Dunlap, KS
CANYON CLIMBER (Radio Shack)	53,100 ★Jim Davis, Sandwich, IL		10,222,940 Clinton Morell, Sacramento, CA
1,725,100 ★John Guptill, Columbia, MO	52,600 Eric Olson, Wheaton, IL		7,493,340 Stirling Dell, Dundalk, Ontario
1,627,500 Matthew Fumich, Munford, TN	DOWNLAND (Radio Shack)		GHANA BWANA (Radio Shack)
213,400 Sara Mittelstaedt, Kiel, WI	99,980 ★Danny Wimett, Rome, NY		2,350,750 ★Michael Heitz, Chicago, IL
202,000 David Brown, New Waterford, Nova Scotia	98,985 Karl Gulliford, Summerville, SC		702,520 Joseph Delaney, Augusta, GA
	97,740 Stephane Deshaies, Beloeil, Quebec		105,820 David Reash, Hadley, PA
178,200 Darren King, Yorkton, Saskatchewan	89,490 Neil Edge, Williston, FL		GIN CHAMPION (Radio Shack)
CASHMAN (MichTron)	77,254 Tom Audas, Fremont, CA		1,120-0 ★Kim Johns, Port Cogh., British Columbia
9,870 ★Martin Parada, Arcadia, CA	73,346 Jean-Francois Morin, Loretteville, Quebec		GROBOT (Children's Computer Workshop)
CLOWNS & BALLOONS (Radio Shack)	70,142 Chris Goodman, Baltimore, MD		8,090 ★Curt Lebel, Louisville, KY
688,960 ★Faye Keefer, Augusta, GA	68,142 Cooper Valentin, Vavenby, British Columbia		HITCHHIKER'S GUIDE TO THE GALAXY (Infocom)
217,500 Frankie DiGiovanni, Olney, MD	67,721 Keith Yampanis, Jaffrey, NH		400/359 ★Roy Grant, Toledo, OH
70,180 Charles Andrews, Delta Jct, AK	62,442 Eddie Lawrence, Pasadena, Newfoundland		400/422 Jeff Holtham, Waterloo, Ontario
36,650 Melody Webb, Lakeport, CA	55,300 Patricio Gonzalez, Buenos Aires, Argentina		400/510 Brad Wilson, Lithia Springs, GA
33,710 Timm Cappell, Freeland, MI	49,500 Danny Perkins, Clifton Forge, VA		INTERBANK INCIDENT (Radio Shack)
COLOR BASEBALL (Radio Shack)	49,441 Kevin Pater, Port Alberni, British Columbia		4,861 ★Shara and Chris Euton, Lilburn, GA
238-0 ★John Valentine, Marlborough, CT	49,254 David Brown, New Waterford, Nova Scotia		IRON FOREST (Diecom Products)
119-0 ★Adam Silverstein, Chicago, IL	43,502 Mike Ellis, Charlotte, MI		3,173,200 ★Charles Boyd, Amarillo, TX
111-2 David Czarnecki, Northhampton, MA	43,369 Jason Kloostra, Jenison, MI		2,676,300 Janet Boyd, Amarillo, TX
96-0 ★Chad Blick, Irwin, PA	41,896 Antonio Hidalgo, San Jose, Costa Rica		1,141,650 Craig Pennell, Amarillo, TX
43-0 ★JASON Kopp, Downs, IL	40,360 Jesse Binns, Phoenix, AZ		1,013,100 William Weller, Kailua, HI
COLOR CAR (NOVASOFT)	35,611 Adam Broughton, Morris, PA		595,700 Daniel Wibier, Santa Rosa, CA
316,550 ★Alan Martin, Cornwall, Ontario	35,169 Daniel Norris, New Albany, IN		JOKER POKER (THE RAINBOW, 3/87)
113,970 Chad Blick, Irwin, PA	23,649 Jim Herr, Newton, WI		43,616,750 ★Carole Rueckert, Mansfield, OH
110,870 Martin Parada, Arcadia, CA	22,366 Tommy Herr, Newton, WI		8,179,710 Brenda Kim, Athens, OH
COLOR POKER (THE RAINBOW, 4/83)	19,579 Steven Turcotte, Matane, Quebec		3,796,898 Curtis Trammel, Murphysboro, IL
44,022,600 ★Earl Foster, Lynchburg, VA	DRAGON FIRE (Radio Shack)		2,793,285 Blain Jamieson, Kingston, Ontario
DALLAS QUEST (Radio Shack)	160,835 ★Eric Olson, Wheaton, IL		205,239 Paul Dykes, Baton Rouge, LA
81 ★Brad Wilson, Lithia Springs, GA	146,325 Stephane Martel, Laval, Quebec		18,889 Frankie DiGiovanni, Olney, MD
85 Paul Summers, Orange Park, FL	11,726 Marcos Rodriguez, New York, NY		JUNIOR'S REVENGE (Computerware)
85 David and Shirley Johnson, Leicester, NC	9,861 Michael Adams, Columbia, SC		2,503,000 ★Stephane Martel, Laval, Quebec
	9,200 Jesse Cogdell, Wilmington, DE		257,600 Keith Cohen, Rocky Mount, NC
86 Roy Grant, Toledo, OH	ENCHANTER (Infocom)		KARATE (Diecom Products)
86 Melanie Moor, Florence, AL	400/223 ★Konnie Grant, Toledo, OH		31,000 ★Wayne Hufford, Kincardine, Ontario
87 Andrew Yarrow, Easthampton, MA	ESCAPE 2012 (Computerware)		21,600 Daniel Hartmann, Osoyoos, British Columbia
87 Douglas Bell, Duncan, OK	202 ★Roy Grant, Toledo, OH		11,600 Jonathon Ross, Pocomoke City, MD
102 Hugh Flournoy, Jr., Spanaway, WA	199 Milan Parekh, Anaheim, CA		6,300 David Darling, Longlac, Ontario
DEF MOV (THE RAINBOW, 1/87)	FIRESTORM (THE RAINBOW, 1/86)		5,600 Steven Turcotte, Matane, Quebec
43,806 ★Domingo Martinez, Miami, FL	22,505 ★Chad Presley, Luseland,		KORONIS RIFT (Epyx)
35,331 David Schaller, Clarkston, WA			186,710 ★Tony Harbin, Cullman, AL
31,673 Douglas Bacon, Middletown, CT			184,180 Russell Johnson, Sarnia, Ontario
30,753 Pasha Irshad, Silver Spring, MD			184,120 John Farrar, Lebanon, TN
30,326 Frederick Lajoie, Nova Scotia, Canada			174,810 Donald Cathcart, Halifax, Nova Scotia
DEMON ATTACK (Imagic)			133,990 Paul Blessing, Spring, TX
279,435 ★Jon Hobson, Plainfield, WI			KUNG-FU DUDE (Sundog Systems)
202,260 Tom Briggs, Hillsdale, NY			32,000 ★Tony Geitgey, University Park, PA

SCOREBOARD

12,150 THE LAIR (<i>Freebooter Software</i>) 112,940 ★James Walton, Pittsburgh, PA	125 100 PYRAMIX (<i>ColorVenture</i>) 67,850 ★Richard Winkelbauer, Bronx, NY 56,970 Andy Freeman, Turtle Lake, WI 37,500 Matthew Smith, Courtenay, British Columbia 26,900 Todd Kopke, Glendale Heights, IL 20,120 Lori Curran, La Porte City, IA	THEXDER (<i>Sierra On-Line</i>) 1,411,700 ★Steve Hallin, Biloxi, MS 1,314,100 Frankie DiGiovanni, Olney, MD 312,300 Timothy DeJong, Rock Valley, IA 195,000 Emmett Keyser, Napa, CA TREASURE QUEST (<i>THE RAINBOW, 11/86</i>) 66,760 ★Clara Smith, Courtenay, British Columbia 29,340 Matthew Smith, Courtenay, British Columbia
260,427 ★Tom Beecker, Gracey, KY 259,493 Cody Deegan, Fallon, NV 255,625 John Valentine, Marlborough, CT 246,668 Phillip Holsten, Modesto, CA 175,771 Jim Davis, Sandwich, IL LUNAR-ROVER PATROL (<i>Spectral Associates</i>) 37,890 ★Dave Staub, Moundsville, WV 30,000 Vincent Tremblay, Matane, Quebec MAGIC OF ZANTH (<i>Computerware</i>) 31 ★Paul Summers, Orange Park, FL 44 Matthew Smith, Courtenay, British Columbia 45 Michael Green, Ware, MA 47 Robert Williams, Yellowknife, Northwest Territory	8,407,772 ★John Haldane, Tempe, AZ 1,404,000 Curtis Goodson, Sao Paulo, Brazil 1,201,383 Milan Parekh, Anaheim, CA 1,003,104 Elisa Goodson, Sao Paulo, Brazil 326,192 Martin Parada, Arcadia, CA RESCUE ON FRONTALUS (<i>Epyx</i>) 1,000,948 ★Steven Ujvary, Calgary, Alberta 323,167 Kenneth Hill, Severna Park, MD 292,633 David Richards, Huntington, WV 288,084 Donald Cathcart, Halifax, Nova Scotia 270,000 Russell Johnson, Sarnia, Ontario RETURN OF THE JET-I (<i>ThunderVision</i>) 336,583 ★Jesse Collicott, Inman, KS RETURN OF JUNIOR'S REVENGE (<i>Colorware</i>) 1,792,800 ★Chad Presley, Luseland, Saskatchewan	TREKBOER (<i>Mark Data</i>) 123 ★Roy Grant, Toledo, OH 132 Matthew Fumich, Munford, TN TRIG ATTACK (<i>Sugar Software</i>) 196,000 ★Cassandra Stewart, Sacramento, CA TUT'S TOMB (<i>Mark Data</i>) 118,720 ★Reina Roy, Carleton, Quebec 74,780 Mack Haynes, Nice, CA 72,000 Chad Presley, Luseland, Saskatchewan 60,020 Don Siler, Muncie, IN 45,000 Blake Cadmus, Reading, PA VARLOC (<i>Radio Shack</i>) 2,032 ★Tony Harbin, Cullman, AL 2,032 ★Edward Rocha, Cobleskill, NY 2,011 Antonio Souza III, North Dartmouth, MA 2,008 Philip Puffinburger, Winchester, VA 1,995 Denise Rowan, Minneapolis, MN 1,991 Ryan Grady, Newbury Park, CA 1,988 Randall Edwards, Dunlap, KS
5,960 5,528 MEMOCARDS (<i>THE RAINBOW, 8/87</i>) 1,418 ★Edward Kavanaugh, North Easton, MA 1,414 Sara Mittelstaedt, Kiel, WI MISSION: F-16 ASSAULT (<i>Diecom Products</i>) 468,750 ★Karen Jessen, Cleveland, OH 355,570 Stirling Dell, Dundalk, Ontario 318,160 Jeremy Pruski, Sandwich, IL 144,510 Donald Cathcart, Halifax, Nova Scotia 137,920 Mike Grant, Fresno, CA MUNCHKIN BLASTER (<i>THE RAINBOW, 8/87</i>) 11,950 ★Jim Davis, Sandwich, IL 10,420 Gabe Emerson, Baraboo, WI 9,760 Tom Beecker, Gracey, KY 9,270 Edward Kavanaugh, North Easton, MA 9,080 John Weaver, Amsterdam, NY	ROGUE (<i>Epyx</i>) 63,934 ★Marshall Weisenburger, Quincy, IL 43,222 Hans Lutenecker, Madison, IA 27,542 Melanie Lapoint, Fitchburg, MA 21,662 Paul Blessing, Spring, TX 17,851 Yvan Langlois, Laval, Quebec 15,445 Frankie DiGiovanni, Olney, MD SANDS OF EGYPT (<i>Radio Shack</i>) 67 ★Tristan Terkuc, Richmond, Ontario 82 Edward Rocha, Cobleskill, NY 85 Paul Summers, Orange Park, FL 86 Roy Grant, Toledo, OH 87 Neil Haupt, Elyria, OH SAUCER DEFENSE (<i>THE RAINBOW, 4/87</i>) 40,000 ★David Hartmann, Osoyoos, British Columbia 4,000 Frankie DiGiovanni, Olney, MD SHAMUS (<i>Radio Shack</i>) 25,450 ★John Garness, Newell, SD SHOOTING GALLERY (<i>Radio Shack</i>) 27,270 ★Jocelyn Hellyer, Montgomery, IL 25,510 Donald Knudson, Minot, ND 20,480 Kevin Pereira, Corsicana, TX SHOOT'N RANGE (<i>THE RAINBOW, 8/87</i>) 55,623 ★Paul Robbins, Picayune, MS 14,702 Richard Winkelbauer, Bronx, NY 13,794 Phillip Holsten, Modesto, CA 5,433 Benoit Landry, Drummondville, Quebec	WARP FACTOR X (<i>Prickly-Pear</i>) 10,577,051 ★Doug Lute, Clymer, PA WILDWEST (<i>Tom Mix</i>) 35 ★Paul Summers, Orange Park, FL WISHBRINGER (<i>Infocom</i>) 400/201 ★Brad Wilson, Lithia Springs, GA WIZARD'S DEN (<i>Tom Mix</i>) 195,050 ★Mark Touchette, Preston, CT WRESTLE MANIAC (<i>Diecom</i>) 956,971 ★Marc Reiter, Cincinnati, OH 546,315 Louis Bouchard, Gatineau, Quebec 45,483 Tony Bacon, Mt. Vernon, IN 42,105 David Brown, New Waterford, Nova Scotia 39,086 Billy Helmick, Independence, KY ZAKSUND (<i>Elite Software</i>) 357,550 ★Martin Parada, Arcadia, CA 268,350 Tony Bacon, Mt. Vernon, IN 44,900 Michael Adams, Columbia, SC 39,950 Walter Hearne, Pensacola, FL ZAXXON (<i>Datasoft</i>) 2,061,000 ★Byron Alford, Raytown, MO 1,950,000 Blake Cadmus, Reading, PA 1,300,500 Dan Brown, Pittsford, NY 1,100,800 Andrew Urquhart, Metairie, LA 376,600 Matthew Yarrow, Easthampton, MA 57,895 Vincent Tremblay, Matane, Quebec
MEGA-BUG (<i>Radio Shack</i>) 9,016 ★Heather Richwalski, Medford, WI 8,199 Eric Mellon, Newark, DE 6,404 David Hartmann, Osoyoos, British Columbia 5,960 Mary Jensen, El Cajon, CA 5,528 Douglas Bacon, Middletown, CT MEMOCARDS (<i>THE RAINBOW, 8/87</i>) 1,418 ★Edward Kavanaugh, North Easton, MA 1,414 Sara Mittelstaedt, Kiel, WI MISSION: F-16 ASSAULT (<i>Diecom Products</i>) 468,750 ★Karen Jessen, Cleveland, OH 355,570 Stirling Dell, Dundalk, Ontario 318,160 Jeremy Pruski, Sandwich, IL 144,510 Donald Cathcart, Halifax, Nova Scotia 137,920 Mike Grant, Fresno, CA MUNCHKIN BLASTER (<i>THE RAINBOW, 8/87</i>) 11,950 ★Jim Davis, Sandwich, IL 10,420 Gabe Emerson, Baraboo, WI 9,760 Tom Beecker, Gracey, KY 9,270 Edward Kavanaugh, North Easton, MA 9,080 John Weaver, Amsterdam, NY	RETURN OF THE JET-I (<i>ThunderVision</i>) 336,583 ★Jesse Collicott, Inman, KS RETURN OF JUNIOR'S REVENGE (<i>Colorware</i>) 1,792,800 ★Chad Presley, Luseland, Saskatchewan ROGUE (<i>Epyx</i>) 63,934 ★Marshall Weisenburger, Quincy, IL 43,222 Hans Lutenecker, Madison, IA 27,542 Melanie Lapoint, Fitchburg, MA 21,662 Paul Blessing, Spring, TX 17,851 Yvan Langlois, Laval, Quebec 15,445 Frankie DiGiovanni, Olney, MD SANDS OF EGYPT (<i>Radio Shack</i>) 67 ★Tristan Terkuc, Richmond, Ontario 82 Edward Rocha, Cobleskill, NY 85 Paul Summers, Orange Park, FL 86 Roy Grant, Toledo, OH 87 Neil Haupt, Elyria, OH SAUCER DEFENSE (<i>THE RAINBOW, 4/87</i>) 40,000 ★David Hartmann, Osoyoos, British Columbia 4,000 Frankie DiGiovanni, Olney, MD SHAMUS (<i>Radio Shack</i>) 25,450 ★John Garness, Newell, SD SHOOTING GALLERY (<i>Radio Shack</i>) 27,270 ★Jocelyn Hellyer, Montgomery, IL 25,510 Donald Knudson, Minot, ND 20,480 Kevin Pereira, Corsicana, TX SHOOT'N RANGE (<i>THE RAINBOW, 8/87</i>) 55,623 ★Paul Robbins, Picayune, MS 14,702 Richard Winkelbauer, Bronx, NY 13,794 Phillip Holsten, Modesto, CA 5,433 Benoit Landry, Drummondville, Quebec	WILDWEST (<i>Tom Mix</i>) 35 ★Paul Summers, Orange Park, FL WISHBRINGER (<i>Infocom</i>) 400/201 ★Brad Wilson, Lithia Springs, GA WIZARD'S DEN (<i>Tom Mix</i>) 195,050 ★Mark Touchette, Preston, CT WRESTLE MANIAC (<i>Diecom</i>) 956,971 ★Marc Reiter, Cincinnati, OH 546,315 Louis Bouchard, Gatineau, Quebec 45,483 Tony Bacon, Mt. Vernon, IN 42,105 David Brown, New Waterford, Nova Scotia 39,086 Billy Helmick, Independence, KY ZAKSUND (<i>Elite Software</i>) 357,550 ★Martin Parada, Arcadia, CA 268,350 Tony Bacon, Mt. Vernon, IN 44,900 Michael Adams, Columbia, SC 39,950 Walter Hearne, Pensacola, FL ZAXXON (<i>Datasoft</i>) 2,061,000 ★Byron Alford, Raytown, MO 1,950,000 Blake Cadmus, Reading, PA 1,300,500 Dan Brown, Pittsford, NY 1,100,800 Andrew Urquhart, Metairie, LA 376,600 Matthew Yarrow, Easthampton, MA 57,895 Vincent Tremblay, Matane, Quebec
ONE-ON-ONE (<i>Radio Shack</i>) 1,302-0 ★Thomas Payton, Anderson, SC 1,276-0 Jonathan Dorris, Indianapolis, IN 1,260-0 Brandon Reece, Chickamauga, GA 1,242-0 William Currie, Bryans Road, MD 1,210-0 Gregg Thompson, Chesterfield, VA OUTHOUSE (<i>MichTron</i>) 38,640 ★Dave Staub, Moundsville, WV PAC PANIC (<i>Cougar</i>) 34,950 ★Heather Hamblen, Bar Harbor, ME PINBALL (<i>Radio Shack</i>) 1,139,450 ★Benoit Landry, Drummondville, Quebec 399,350 Troy Stoil, Washington, IN 389,463 Thomas Payton, Anderson, SC 213,300 Patrick Martel, Laval, Quebec 142,400 Thomas Payton, Anderson, SC PITFALL II (<i>Activision</i>) 197,048 ★Keith Catrett, Montgomery, AL 159,400 David Cornette, Green Bay, WI 104,479 David Stewart, Kent, OH PITSTOP II (<i>Epyx</i>) 54 ★Rusty Breitbach, Rickardsville, IA 54 ★Jeff Coburn, Easton, PA 54 ★Walter Hearne, Pensacola, FL 54 ★Sean Noonan, Green Bay, WI 54 ★Thomas Payton, Anderson, SC 54 ★Jeff Szczerba, Sturtevant, WI 54 ★Brad Wilson, Lithia Springs, GA 51 Christian Grenier, Valleyfield, Quebec 49 Randy Venable, Coal City, WV 14 Eric Mellon, Newark, DE 9 Laundre Clemon, Sacramento, CA	SPACE ASSAULT (<i>Radio Shack</i>) 13,110 ★Jeff Remick, Warren, MI 7,280 Jason Kopp, Downs, IL 6,200 John Weaver, Amsterdam, NY SPEEDSTER (<i>THE RAINBOW, 8/87</i>) 103,140 ★Richard Winkelbauer, Bronx, NY 88,090 Jason Landreth, Texico, IL 44,540 Kevin Pereira, Corsicana, TX 37,970 Frederick Lajoie, Nova Scotia, Canada 35,040 John Valentine, Marlborough, CT 32,110 Lisa Williamson, Watauga, TX SPIDERCIDE (<i>Radio Shack</i>) 27,730 ★Mike LeBrun, Cornwall, Ontario 1,840 Dave Staub, Moundsville, WV SPRINGSTER (<i>Radio Shack</i>) 303,520 ★Mavis Hartmann, Osoyoos, British Columbia SUPER ROOTER (<i>THE RAINBOW, 5/86</i>) 19,090 ★Frederick Lajoie, Nova Scotia, Canada 15,180 Richard Donnell, Penns Grove, NJ 3,910 Daniel Bradford, Birmingham, AL TEMPLE OF ROM (<i>Radio Shack</i>) 604,000 ★Troy Graham, Arnold, MD 507,700 Adam Broughton, Morris, PA 303,600 Tim Hennon, Highland, IN 138,400 Gary Budzak, Westerville, OH 125,200 Michelle Murray, Salem, IN	ZEUS (<i>Aardvark</i>) 4,500 ★Benoit St-Jean, Gatineau, Quebec 3,380 Martin Kertz, Forrest City, AR ZORK I (<i>Infocom</i>) 350/328 ★Konnie Grant, Toledo, OH 350/587 Matthew Yarrow, Easthampton, MA ZONX (<i>THE RAINBOW, 10/85</i>) 12,000 ★Adam Broughton, Morris, PA

— Jody Doyle

SCOREBOARD POINTERS

In conjunction with THE RAINBOW's Scoreboard, we offer this column of pointers for our game-playing readers' benefit. If you have some interesting hints, tips or responses to questions, or want help yourself, we encourage you to write to the Scoreboard, c/o THE RAINBOW.

In response to questions from:

● Duncan Cameron: To get to the blue doors in *Bedlam*, you must be in your cell. From there, type OPEN GREEN DOOR. Then go south, east, open the green door, go north and get Napoleon to follow you. Go south, ask Napoleon to open the red door and go south again. You will find the blue doors as you go through the north-south hallway.

To get the red key, go to the cabinet where the red key is located and type GO WEST. Take the window hook and go east. Take the red key with the window hook. You do not necessarily need the red key, just get Napoleon to follow you. When you need a door opened, whether it is green, red or blue, just type NAPOLEON OPEN RED DOOR (or whatever color door you need opened).

Jon Hobson
Plainfield, WI

● James Green: It is impossible to retrieve the wizard's image scroll in *Dungeons of Daggorath*. The third ring is in the level after you kill the wizard's image; it comes from a goldrog and is the joule ring. Incant it to the energy ring; you need this to help kill the evil wizard. The elvish sword also comes from a goldrog; you need this for the wizard as well.

● Robert Sherman: In order to get the flashlight in the Chugalug trading post in *Dallas Quest*, you must pull the curtain, then give the monkey the tobacco. Drop everything except the flashlight, and type CLIMB LADDER. Before going down into the pit, turn the light on. In the pit go east, enter the post, get the sack, put everything in it and climb down. Get the light and go west.

Andy Yarrows
Easthampton, MA

● Jason Ebeling: To row the boat in *Dallas Quest*, you have to type ROW BOAT; you must have the small shovel.

After giving the eggs to the natives and giving the mirror to the monkey, what do you do? How do you get to the cave?

Sagie Kraidman
Brooklyn, NY

Scoreboard:

I am stuck on Level 9 in *Bouncing Boulders* and can only get about five out of 25 gems. Can anyone give me some advice to get all of them so I can get to Level 10?

Troy Grice
Sinton, TX

Scoreboard:

I have gotten as far as the iron castle in *Caladuril Flame of Light*, but I can't get across the blue and red game board. I have the map the parrot gave me, but when I step on the last square of the "safe route" I get zapped.

In *In Search of the Star Lord*, I can't find the control circuit for the laser barricades.

Floyd Resler
Cincinnati, OH

Scoreboard:

When I get to the island in *Calixto Island*, I cannot get past the natives.

Clifford Lingle
Overland Park, KS

Scoreboard:

What do you do with the eggs in *Dallas Quest* once you're in the cave?

Danielle Ramsey
Centralia, MO

Scoreboard:

In *Dallas Quest* I cannot get out of the tree after I jump out of the plane.

I die before I can get to the pool in *Sands of Egypt*. Please help.

Andrea Jenkins
Gander, Newfoundland

Scoreboard:

In *Finding Enrakian Treasure* I need to know what to do in the colored rooms. Where is the bullet? How do I get the rose?

How do I get past the rats and through the locked door by the diner in *Sam Diamond P.I.*?

In *SYZYGY* what do I do with the sword, knife, string, blanket and space-suit? How do I work the transporter console? Where do I find this fuzzy creature I've heard about? What use is the elevator?

Angela Aldred
East Peoria, IL

Scoreboard:

How can I open the lock mechanism in *Graphic Pyramid*? How can I go back to the archeologist hut with the treasures?

J.P. Brassard
Jonquiere, Quebec

Scoreboard:

In *Lansford Mansion* how do you prevent the guard from throwing you out several moves after you yell fire?

How do you prevent from getting killed by sand when you dig in *Infidel*?

Ed Gilliland
Southfield, MI

Scoreboard:

I need help getting past the cliff and other places in *Martian Crypt*. Any hints, tips and vocabulary would be appreciated.

Jon Miller
St-Lambert, Quebec

Scoreboard:

How do I get to the central computer in *Thexder* after I have completed the 15 levels?

Glenn Laws
Toledo, OH

Scoreboard:

After I deliver the letter to the magic shop in *Wishbringer*, I come down the mountain, but I cannot get past the troll at the covered bridge. He wants a gold coin, but I don't have any. How do I get past him?

In *Dallas Quest* when you leave the trading post, how do you get to the cannibals?

H. James Herchek
Cleveland Heights, OH

To respond to other readers' inquiries and requests for assistance, reply to "Scoreboard Pointers," c/o THE RAINBOW, P.O. Box 385, Prospect, KY 40059. We will share your reply with all "Scoreboard" readers in an upcoming issue.

For greater convenience, "Scoreboard Pointers" and requests for assistance may also be sent to us through the MAIL section of our Delphi CoCo SIG. From the CoCo SIG> prompt, pick MAIL, then type SEND and address to: EDITORS. Be sure to include your complete name and address.



*Keep track of the body count
in role-playing games*

The "Hit" List

By Andrew Dater

Since 1981, a new role-playing game has swept across the nation. The game is *Killer*. Unlike those in other role-playing games, the players are the *actual* characters; they go around shooting other players with squirt or dart guns, blowing them up with water balloon hand grenades, and blasting them with flashlight lasers.

Most games involve some sort of scenario. For instance, in the *Circle of Death* you are given a victim to "kill." If you "off" your victim, you go after your victim's victim, and so on. But watch out, the same thing is happening behind you, and if you're not careful, it could happen to you!

Or you may be playing the *Mafia* scenario. This one pits rival gangs against each other, with one team designated as the FBI. Not only do you try to "kill" your opponents, but you try to amass enormous wealth. But be careful because, just as in real life, the gangs have spies, and you may not live to see tomorrow if you're found out!

The person who organizes the game must keep track of large amounts of data. This includes who was killed, how many points earned, personal information, and so on. What could be better for keeping track of all this information than good ol' *CoCo*?

The Assassination Game Utility is very easy to use. It runs from a main

*Andy Dater works for Tandy as a training and support specialist in the Business Products division. He is involved in many role-playing games, and playing *Killer* was a natural progression into real-life role-playing. Andy's username on Delphi is DATER.*

menu of 10 choices. All you have to do is press 0 through 9 and you are taken to the appropriate subroutine.

Throughout the program, if you want to return to the menu, press Q. On options 2, 3 and 4, when it asks for the player's name, press ENTER. It will ask you for a code name if you can remember it more easily.

Options 1 through 3 let you add, edit or remove players. When players are created, they are automatically made alive and active. Both of these may be changed using Option 4. The program allows for only 40 players, so if you near the limit, you may delete players or change the DIM statement if memory allows.

Option 4 allows you to change the amount of kill, bonus and penalty points a player has and change the alive and active statuses. If a player is in the round you are currently running, he must be active and either alive or dead. If a player you have on your list is not playing the current round, he must be made inactive. After you make the necessary changes, press Q to return to the menu and press the space bar to change another player.

Options 5 and 6 take care of points for staying alive each day and points for not making a kill after a certain number of days. Option 7 separates the players by their being either "alive" or "dead," sorting them by points from highest to lowest, and then prints out the list to the printer.

Option 8 sorts the players alphabetically and then returns to the menu (this is so the players will be in alphabetical order when you do a list). Option 9 lists the players and their code names to the

screen. If you print the list to the printer, the alive and active statuses will also be printed.

Before you run the program for the first time or after you have killed the data file, you must run the following listing, which creates a "dummy" data file:

```
10 OPEN"0",1,"TAG"
20 PRINT#1,0
30 CLOSE
```

If you find that the data categories don't suit your needs, you can change the category titles in Line 3040. You should not, however, change first name, last name or code name.

I have used the speed-up poke in the two sort routines, so for those of you whose computers can't handle it, delete lines 960 and 2130.

This program helps me a lot when I run rounds of The Assassination Game and have to keep track of points. I hope

it will help you if you plan on running a round.

If you want more information about the game, go to your local hobby or game store and look for the book called *Killer*, by Steve Jackson. It is a manual on the game and it explains it very well.

(Questions about this program may be addressed to the author at 23751 Albers, Woodland Hills, CA 91367. Please enclose an SASE for a written reply.)

25052	1730251
440255	1970124
65078	2160200
840188	245039
110040	2600196
1300161	2880255
1520159	END166

The listing: KILLER

```
10 'THE ASSASSINATION GAME
20 '(C) 1986 ANDY DATER
30 GOTO3050
40 FILES1: CLEAR12000: DIMD$(40,18)
,TS$(40,17),SM$(17),P(4)
50 CLS:PRINT"LOADING DATA..."
60 OPEN"I",1,"TAG/DAT"
70 INPUT#1,R
80 IFR=0THEN130
90 FORX=1TOR
100 FORY=1TO17
110 LINEINPUT#1,D$(X,Y)
120 NEXTY,X
130 CLOSE
140 FORX=1TO11
150 READD$(0,X)
160 NEXTX
170 CLS:P$="THE ASSASSINATION GA
ME":GOSUB2800
180 PRINT
190 PRINTTAB(5)"1 - ADD PLAYER"
200 PRINTTAB(5)"2 - EDIT PLAYER"
210 PRINTTAB(5)"3 - DELETE PLAYE
R"
220 PRINTTAB(5)"4 - CHANGE POINT
S"
230 PRINTTAB(5)"5 - DAILY BONUS
S"
240 PRINTTAB(5)"6 - NON-KILL PEN
ALTIES"
250 PRINTTAB(5)"7 - PRINT POINTS
LIST"
260 PRINTTAB(5)"8 - SORT LIST"
270 PRINTTAB(5)"9 - LIST PLAYERS
"
280 PRINTTAB(5)"0 - QUIT"
290 QS=INKEY$:IFQS<"0"ORQS>"9"TH
EN290
```

```
300 A$="":B$="":N=0
310 ONVAL(Q$)+1GOSUB2690,340,500
,720,1140,1630,1890,2110,950,255
0
320 IS$="":GOTO170
330 'ADD PLAYER
340 CLS:P$="ADD PLAYER":GOSUB280
0
350 GOSUB2850
360 R=R+1
370 FORX=1TO11
380 L=76+32*X
390 GOSUB2970
400 IF(IS$="Q"ORIS$="")ANDX=1THENR
=R-1:RETURN
410 D$(R,X)=IS$
420 NEXTX
430 FORX=12TO15:D$(R,X)=STR$(0):
NEXTX:D$(R,16)="ALIVE":D$(R,17)=
"Y"
440 PRINT@480,"ARE ENTRIES CORRE
CT? (Y/N/Q)";
450 A$=INKEY$:IFA$="N"THENN=R:GO
TO630ELSEIFA$="Q"THENRETURNELSEI
FA$<>"Y"THEN450
460 PRINT@480,"ADD ANOTHER? (Y/N
)";
470 A$=INKEY$:IFA$="Y"THENPRINT@
480,STRING$(31," ");:GOTO350ELSE
IFA$<>"N"THEN470
480 RETURN
490 'EDIT PLAYER
500 CLS:P$="EDIT PLAYER":GOSUB28
00
510 PRINT@96,"";:LINEINPUT"NAME:
";A$
520 IFA$="Q"THENRETURN
530 IFA$<>" "THEN560
540 LINEINPUT"CODENAME: ";A$
550 IFA$=""THENRETURNELSE590
560 Q=INSTR(A$," ")
570 IFQ=0THENA$=""GOTO500
580 B$=RIGHT$(A$,LEN(A$)-Q):A$=L
EFT$(A$,Q-1)
590 FORN=1TOR
600 IFA$=D$(N,1)ANDB$=D$(N,2)THE
N630ELSEIFA$=D$(N,3)THEN630ELSEN
EXTN
610 PRINT"NOT FOUND."
```



```

62Ø EXEC44539:GOTO5ØØ
63Ø AN=1:AD=1:GOSUB285Ø
64Ø A$="":PRINT@448,STRING$(31,"
");:PRINT@448,"";:LINEINPUT"CHA
NGE WHICH FIELD: ";A$
65Ø IFA$="Q"THENRETURNELSEA=VAL(
A$)
66Ø IFA<LORA>1LORA<>INT(A) THEN64
Ø
67Ø L=112+32*(A-1)
68Ø GOSUB297Ø
69Ø IFI$=""THENPRINT@L,D$(N,A);E
LSED$(N,A)=I$
7ØØ GOTO64Ø
71Ø 'DELETE PLAYER
72Ø CLS:P$="DELETE PLAYER":GOSUB
28ØØ
73Ø PRINT@96,"";:LINEINPUT"NAME:
";A$
74Ø IFA$="Q"THENRETURN
75Ø IFA$<>" THEN78Ø
76Ø LINEINPUT"CODENAME: ";A$
77Ø IFA$=""THENRETURNELSE1Ø
78Ø Q=INSTR(A$," ")
79Ø IFQ=ØTHENA$="":GOTO72Ø
8ØØ B$=RIGHT$(A$,LEN(A$)-Q):A$=L
EFT$(A$,Q-1)
81Ø FORN=1TOR
82Ø IFA$=D$(N,1)ANDB$=D$(N,2)ORA
$=D$(N,3)THEN85ØELSENEXTN
83Ø PRINT"NOT FOUND."
84Ø EXEC44539:GOTO72Ø
85Ø AD=1:GOSUB285Ø
86Ø PRINT@48Ø,"ARE YOU SURE? (Y/
N)";
87Ø A$=INKEY$:IFA$="N"THENRETURN
ELSEIFA$<>"Y"THEN87Ø
88Ø FORX=N+1TOR

```

```

89Ø FORY=1TO17
9ØØ D$(X-1,Y)=D$(X,Y)
91Ø NEXTY,X
92Ø R=R-1
93Ø RETURN
94Ø 'SORT LIST
95Ø CLS:PRINT"SORTING..."
96Ø POKE65495,Ø
97Ø FORP=1TOR
98Ø PRINT@32,P;
99Ø SM$(1)=CHR$(255):SM$(2)=CHR$(
255)
1ØØØ FORA=1TOR
1Ø1Ø PRINT@4Ø,A;
1Ø2Ø IFD$(A,2)+D$(A,1)<SM$(2)+SM
$(1)THENFORX=1TO17:SM$(X)=D$(A,X
):NEXTX:SB=A
1Ø3Ø NEXTA
1Ø4Ø FORX=1TO17:T$(P,X)=SM$(X):N
EXTX
1Ø5Ø D$(SB,1)=CHR$(255):D$(SB,2)
=CHR$(255)
1Ø6Ø NEXTP
1Ø7Ø FORX=1TOR
1Ø8Ø FORY=1TO17
1Ø9Ø D$(X,Y)=T$(X,Y)
11ØØ NEXTY,X
111Ø POKE65494,Ø
112Ø RETURN
113Ø 'CHANGE POINTS
114Ø CLS:P$="CHANGE POINTS":GOSU
B28ØØ
115Ø PRINT@96,"";:LINEINPUT"NAME
: ";A$
116Ø IFA$="Q"THENRETURN
117Ø IFA$<>" THEN12ØØ
118Ø LINEINPUT"CODENAME: ";A$
119Ø IFA$=""THENRETURNELSE123Ø
12ØØ Q=INSTR(A$," ")
121Ø IFQ=ØTHENA$="":GOTO114Ø
122Ø B$=RIGHT$(A$,LEN(A$)-Q):A$=
LEFT$(A$,Q-1)
123Ø FORN=1TOR
124Ø IFA$=D$(N,1)ANDB$=D$(N,2)TH
EN127ØELSEIFA$=D$(N,3)THEN127ØEL
SENEXTN
125Ø PRINT"NOT FOUND."
126Ø EXEC44539:GOTO114Ø
127Ø PRINT@96,"NAME: "D$(N,1) " "
D$(N,2)
128Ø PRINT"CODENAME: "D$(N,3)
129Ø PRINT
13ØØ FORX=1TO4:P(X)=VAL(D$(N,X+1
)):NEXTX
131Ø P(4)=P(1)+P(2)+P(3)
132Ø PRINT@192,"1 - KILLS: "P
(1)
133Ø PRINT"2 - BONUSES: "P(2)
134Ø PRINT"3 - PENALTIES:"P(3)
135Ø PRINT"4 - TOTAL: "P(4)
136Ø PRINT"5 - STATUS: "D$(N,

```

One-Liner Contest Winner . . .

If you want to traumatize the authority figure in your life, run this program and take potshots at the TV. This one-liner generates a changing pattern of bull's-eyes. If you can find your old rubber-tipped dart guns, you're set for target practice.

The listing:

```

1 PMODE4,1:SCREEN1,1:PCLS:POKE17
8,3:CIRCLE(126,96),2Ø:CIRCLE(126
,96),4Ø:CIRCLE(126,96),6Ø:CIRCLE
(126,96),8Ø:CIRCLE(126,96),92:PA
INT(126,96),,1:POKE178,1:PAINT(4
4,96),,1:POKE178,2:PAINT(48,96),
,1:POKE178,31:PAINT(72,96),,1:FO
RW=1TO5ØØØ:NEXTW:GOTO1

```

*Merwyn Bly
Vienna, VA*

(For this winning one-liner contest entry, the author has been sent copies of both *The Third Rainbow Book of Adventures* and its companion *The Third Rainbow Adventures Tape*.)

```

16)
137Ø PRINT"6 - ACTIVE:      "D$(N,
17)
138Ø PRINT@384,"CHANGE WHICH? (1
-6)
      "
139Ø A$=INKEY$:IF(A$<"1"ORA$>"6"
)ANDA$<>"Q"ANDA$<>" "THEN139ØELS
EA=VAL(A$)
140Ø IFA$="Q"ORA$=" "THEN157Ø
141Ø PRINT@384,STRING$(31," ");:
PRINT@384,"";
142Ø IFA=5THEN147Ø
143Ø IFA=6THEN153Ø
144Ø C=Ø:INPUT"CHANGE";C
145Ø P(A)=P(A)+C
146Ø GOTO131Ø
147Ø PRINT"IS PLAYER <A>LIVE OR
<D>EAD"
148Ø I$=INKEY$:IFI$=""THEN148Ø
149Ø IFI$="A"THEND$(N,16)="ALIVE
":GOTO132Ø
150Ø IFI$="D"THEND$(N,16)="DEAD"
:GOTO132Ø
151Ø IFI$=CHR$(13)THENGOTO132Ø
152Ø GOTO148Ø
153Ø PRINT"IS PLAYER ACTIVE? (Y/
N)"
154Ø I$=INKEY$:IFI$<>"Y"ANDI$<>"
N"THEN154Ø
155Ø D$(N,17)=I$
156Ø GOTO132Ø
157Ø FORX=1TO4
158Ø D$(N,X+11)=STR$(P(X))
159Ø NEXTX
160Ø IFA$=" "THEN114Ø
161Ø RETURN
162Ø 'DAILY BONUSES
163Ø CLS:P$="ADD DAILY POINTS":G
OSUB28ØØ
164Ø PRINT
165Ø INPUT"HOW MUCH TO ADD TO EA
CH ALIVE  PLAYER";A
166Ø IFA=ØTHENRETURNELSECLS
167Ø FORX=1TOR
168Ø IFD$(X,16)="DEAD"ORD$(X,17)
="N"THEN172Ø
169Ø Q=Q+1
170Ø PRINTD$(X,1) " "D$(X,2):PRIN
TTAB(1Ø)D$(X,3)
171Ø IFQ/7=INT(Q/7)THENPRINT@489
,"PRESS <ENTER>";:EXEC44539:CLS
172Ø NEXTX
173Ø PRINT:PRINT"IS LIST CORRECT
? (Y/N)"
174Ø I$=INKEY$:IFI$=""THEN174Ø
175Ø IFI$="Y"THEN178Ø
176Ø IFI$="N"THENPRINT"PRESS <EN
TER> TO RETURN":EXEC44539:RETURN
177Ø GOTO174Ø
178Ø FORX=1TOR
179Ø IFD$(X,16)="DEAD"THEN183Ø
180Ø D$(X,13)=STR$(VAL(D$(X,13)
+A)
181Ø D$(X,15)=STR$(VAL(D$(X,15)
+A)
182Ø N=N+1
183Ø NEXTX
184Ø PRINTN"PLAYERS CHANGED"
185Ø X$=INKEY$
186Ø IFINKEY$=""THEN186Ø
187Ø RETURN
188Ø 'NON-KILL PENALTIES
189Ø CLS:P$="NON-KILL PENALTIES"
:GOSUB28ØØ
190Ø PRINT
191Ø PRINT@96,,:INPUT"HOW MUCH T
O SUBTRACT FROM EACH ALIVE PLAY
ER";S
192Ø IFS=ØTHENRETURN
193Ø IFS<>ABS(INT(S))THEN189Ø
194Ø FORX=1TOR
195Ø IFD$(X,16)<>"ALIVE"ORD$(X,1
7)="N"THEN2Ø6Ø
196Ø PRINT@192,"NAME: "D$(X,1) "
"D$(X,2)+STRING$(12-LEN(D$(X,2)
,32)
197Ø PRINT"CODENAME: "D$(X,3) "
"
198Ø PRINT@288,"KILL POINTS:"D$(
X,12) "
      "
199Ø PRINT"SUBTRACT"S"POINTS? (Y
/N/Q)"
200Ø A$=INKEY$:IFA$=""THEN2ØØØ
201Ø IFA$="Q"THENRETURN
202Ø IFA$="N"THEN2Ø6Ø
203Ø IFA$<>"Y"THEN2ØØØ
204Ø D$(X,14)=STR$(VAL(D$(X,14)
-S)
205Ø D$(X,15)=STR$(VAL(D$(X,15)
-S)
206Ø NEXTX
207Ø PRINT
208Ø PRINT"DONE."
209Ø EXEC44539:RETURN
210Ø 'PRINT POINTS LIST
211Ø CLS:P$="PRINT POINTS":GOSUB
28ØØ
212Ø PRINT:PRINT"SORTING..."
213Ø POKE65495,Ø
214Ø TV=Ø:TR=Ø:A=Ø:NA=Ø:NU=Ø
215Ø FORX=1TOR
216Ø IFLEFT$(D$(X,16),1)="A"ANDD
$(X,17)="Y"THENNA=NA+1
217Ø NEXTX
218Ø FORX=1TOR
219Ø IFD$(X,17)="N"THEND$(X,18)=
"U":NU=NU+1
220Ø NEXTX
221Ø FORX=1TOR
222Ø PRINT@Ø,X;
223Ø FORY=1TOR
224Ø IFVAL(D$(Y,15))=>TV ANDD$(Y

```



```

,18)<>"U"THENTV=VAL(D$(Y,15)):TR
=Y
225Ø NEXTY
226Ø IFLEFT$(D$(TR,16),1)="D"THE
N233Ø
227Ø A=A+1
228Ø FORZ=13TO16
229Ø T$(A,Z)=D$(TR,Z)
230Ø T$(A,3)=D$(TR,3)
231Ø NEXTZ
232Ø GOTO238Ø
233Ø NA=NA+1
234Ø FORZ=13TO16
235Ø T$(NA,Z)=D$(TR,Z)
236Ø T$(NA,3)=D$(TR,3)
237Ø NEXTZ
238Ø D$(TR,18)="U":TV=Ø
239Ø NEXTX
240Ø FORX=1TOR
241Ø D$(X,18)=""
242Ø NEXTX
243Ø POKE65494,Ø
244Ø PRINT@128,"PRINTING..."
245Ø FORX=1TO6:PRINT#-2,"":NEXTX
246Ø PRINT#-2,TAB(11)"CODENAME"TAB
AB(24)"KILLS"TAB(34)"BONUSES"TAB
(46)"PENALTIES"TAB(6Ø)"TOTAL"TAB
(7Ø)"STATUS"
247Ø PRINT#-2,TAB(11)"-----"TAB
AB(24)"-----"TAB(34)"-----"TAB
(46)"-----"TAB(6Ø)"-----"TAB
(7Ø)"-----"
248Ø PRINT#-2,""
249Ø FORX=1TO(R-NU)
250Ø PRINT#-2,TAB(4)T$(X,3)TAB(2
5)T$(X,12)TAB(36)T$(X,13)TAB(49)
T$(X,14)TAB(61)T$(X,15)TAB(71)T$(
X,16)
251Ø NEXTX
252Ø PRINT#-2,CHR$(12);
253Ø RETURN
254Ø 'LIST PLAYERS
255Ø CLS:P$="LIST PLAYERS":GOSUB
28ØØ
256Ø PRINT
257Ø PRINT"PRINT LIST TO PRINTER
? (Y/N/Q)"
258Ø A$=INKEY$:IFA$<>"Y"ANDA$<>"
N"ANDA$<>"Q"THEN258Ø
259Ø IFA$="Q"THENRETURN
260Ø IFA$="Y"THENP=1ELSEP=Ø
261Ø CLS:FORX=1TOR
262Ø PRINTD$(X,1)" "D$(X,2):PRIN
TTAB(1Ø)D$(X,3)
263Ø IFP THENPRINT#-2,D$(X,1)" "
D$(X,2)TAB(28)D$(X,3)TAB(45)D$(X
,16)
264Ø IFX/7=INT(X/7)THENPRINT@489
,"PRESS <ENTER>";:FORQ=ØTO1STEPØ
:Q$=INKEY$:IFQ$="Q"THENRETURNELS
EIFQ$=""THENNEXTQ ELSECLS

```

```

265Ø NEXTX
266Ø PRINT:PRINTR"PLAYERS"
267Ø EXEC44539:RETURN
268Ø 'QUIT
269Ø CLS:PRINT"SAVE DATA? (Y/N)"
270Ø A$=INKEY$:IFA$="N"THENENDEL
SEIFA$<>"Y"THEN27ØØ
271Ø CLS:PRINT"SAVING DATA..."
272Ø OPEN"O",1,"TAG/DAT"
273Ø PRINT#1,R
274Ø FORX=1TOR
275Ø FORY=1TO17
276Ø PRINT#1,D$(X,Y)
277Ø NEXTY,X
278Ø END
279Ø 'CENTER ROUTINE
280Ø T=16-LEN(P$)/2
281Ø PRINTTAB(T)P$
282Ø PRINTTAB(T)STRING$(LEN(P$),
"-")
283Ø RETURN
284Ø 'PRINT TITLES ROUTINE
285Ø FORX=1TO11
286Ø AN$=RIGHT$(STR$(X),1)+" - "
287Ø IFX=1ØTHENAN$="1Ø- "
288Ø IFX=11THENAN$="11- "
289Ø PRINT@64+X*32,"";
290Ø IFAN THENPRINTAN$;
291Ø PRINTD$(Ø,X);
292Ø IFAD THENPRINTD$(N,X)ELSEPR
INT
293Ø NEXTX
294Ø AN=Ø:AD=Ø
295Ø RETURN
296Ø 'INPUT DATA ROUTINE
297Ø I$="":PRINT@L,STRING$(15,32
)
298Ø PRINT@L+LEN(I$),CHR$(191)
299Ø A$=INKEY$:IFA$=""THEN299Ø
3ØØØ IFA$=CHR$(8)ANDLEN(I$) THEN
I$=LEFT$(I$,LEN(I$)-1):PRINTA$;:
GOTO298Ø
3Ø1Ø IFA$=CHR$(21)THEN297Ø
3Ø2Ø IFA$=CHR$(13)THENPRINT@L+LE
N(I$)," ";:RETURN
3Ø3Ø IFASC(A$)<32ORASC(A$)>122TH
EN299ØELSEI$=I$+A$:PRINT@L+LEN(I
$)-1,A$;:GOTO298Ø
3Ø4Ø DATA"FIRST NAME: ","LAST NA
ME: ","CODENAME: ","TELEPHONE
: ","HEIGHT: ","WEIGHT:
","HAIR COLOR: ","EYE COLOR: "
,"CAR DRIVEN: ","ACTIVITIES: ","
GRADE: "
3Ø5Ø PCLEAR1:GOTO4Ø

```



If you have an idea for the "Wishing Well," submit it to Fred c/o THE RAINBOW. Remember, keep your ideas specific, and don't forget this is BASIC. All programs resulting from your wishes are for your use, but remain the property of the author.

Inspiration can come from the strangest sources. That's the whole premise on which this column is based. You, the reader, suggest ideas that I can translate into concrete BASIC programs for your Color Computer.

It has been a long time since I have gotten really excited about a project. Don't misunderstand me: I don't mean that recent "Wishing Well" programs have not been up to snuff. It is just that some suggestions can really light a fire in my head. Every now and then it is nice to be so excited about a program idea that I spend every spare minute creating at the CoCo keyboard, even late into the night.

This month's program is the result of just such an inspiration. *Opposites Vol. 1* is a rather long listing designed for the younger, elementary school-aged CoCo user. It is also the basis for a new "Wishing Well" game that will appear in next month's RAINBOW as well as a few new programming techniques I will introduce to you.

The Motivation

Several months ago I put out a request for old gray CoCos that were gathering dust in people's closets. Since that time, over a dozen kind souls have donated CoCos, disks or disk drives to our special needs program here at Drury High School. As a result, our resource room is now using the Color Computers every single period of the day with either word processing or skills reviews. We are never without a free machine for a student who needs to use one. That is great!

That was not the end of my effort, however. In recent weeks I have been

Fred Scerbo is a special needs instructor for the North Adams Public Schools in North Adams, Massachusetts. He holds a master's in education and has published some of the first software available for the Color Computer through his software firm, Illustrated Memory Banks.

Basic vocabulary for elementary students

Matching Opposites

By Fred B. Scerbo
Rainbow Contributing Editor

able to patch together three more complete systems, using cassettes and some old black-and-white TV sets. (We can always still find good homes for other retired CoCos!) With the three systems in hand, I went to our city's oldest elementary school, originally built around the turn of the century. It is one of our few truly "neighborhood" schools left; in fact, I was there as a student back in the late '50s.

We have three special needs classes at that school, dealing with students who have simple learning disabilities to those with severe emotional and physical handicaps. Among the three classes there was only one computer, an old Atari 800 with only about a dozen or so working programs. In other words, these three classes had no real computer contact at all.

This school was the perfect location for three of these donated CoCos. Without going into great detail, I can now say that just a few weeks later, the Color Computers have become an integral part of each classroom, in use almost every period of the day. All the software used is coming directly from the pages of THE RAINBOW, either from past "Wishing Well" programs or other authors' submissions.

The Inspiration

Naturally, these three teachers are just thrilled to have this added resource in their classes. However, I have not written much software for very young

students, especially those with special needs; I normally work with high school students. I was wide open for any suggestions for programs.

After about a week one of the teachers commented, "These programs are just great, but do you have anything on opposites?"

Opposites! That may seem like too simple a category to cover in a computer program, but keep in mind that special needs students have a real conceptual blockage at times. They may know that hot and cold are similar, but they do not really understand what opposite means. This seemed like a good challenge. Besides, mainstream youngsters could use it, too.

The closest I had come to a program on opposites was my old *Homonyms* program, which could be used with antonyms, as well. However, what the teacher seemed to need was something quite different. Some of her students were only 5 or 6 years old. A text program didn't seem to fit the bill.

She needed something that would really emphasize the opposite nature of two terms, such as over and under, up and down, or happy and sad. The only way to accomplish this in a way that would be useful to the really young required the use of graphics.

The Graphics

At last I had a valid excuse to get back into some exciting graphics creations. As you will recall, it has been some time since creations like *Rockfest* or *Football Fever* showed how to construct impressive CoCo graphics from BASIC. This would be a good opportunity to incorporate simple graphics with concepts. However, some concepts would be harder to represent than others, as I would soon find.

I felt the most effective graphics would be both easily recognizable and large. To accommodate the size, I chose to work in PMODE0.

PMODE0? Don't get excited. There are four very logical reasons for using our lowest-grade high resolution. First, the pixels for PMODE0 are perfect squares only slightly larger than in PMODE4. Second, one screen in PMODE0 occupies only one graphics page; in a regular power-up there are automatically four graphics pages to use, allowing the rapid use of PCOPY in creating screens.

Third, drawing large graphics in

PMODE0 will lend itself perfectly to reduction using the S (size) command in our DRAW statement. (Sometimes when you enlarge or reduce using S, you will get a distorted graphic, especially when using diagonals E, F, G and H. This eliminates the problem.)

Finally, using PMODE0 allows a sharp black-and-white image without color distortion found in the thin lines drawn in PMODE4. Since I want to easily convey a concept in a graphic, straight black and white is the best route to go. Besides, all three CoCo stations I set up were with black-and-white TV sets!

The Program

I do not want to go to great length in explaining the listing, since it is very long due to the amount of data used. Instead, let's simply take a quick look at what the program involves.

There are 40 graphics strings for drawing concepts and text. This makes 20 sets of two opposite matches: up and down, left and right, etc. I chose not to create a graphics set of alphanumeric characters this time, so each string is self-contained with all the information it needs to draw a complete graphic. This may seem the long way of doing

things, but it speeds up execution of the drawing.

In a review section the user can run through each of the 20 sets on the screen alone. There is also a quiz that will highlight a graphic and ask the user to choose the correct opposite match by moving the flashing cursor with the space bar. All the choices are presented randomly, so the program is fairly unlimited in its variety.

A third option is a quiz involving the words only. This allows a good test of whether the concepts have been related to the correct terms.

Using the Program

After the titlecard comes a menu of three choices. The first choice allows review of terms and graphics. Use the ENTER key to advance to each of the next graphics. At the end of the review, the program will rerun itself.

Both quiz sections allow you to check your score by pressing the @ key. You may continue with either quiz by pressing C to continue.

In the graphics quiz, pressing the space bar moves the cursor around the screen. Press ENTER when you are on the correct match. If you are incorrect,

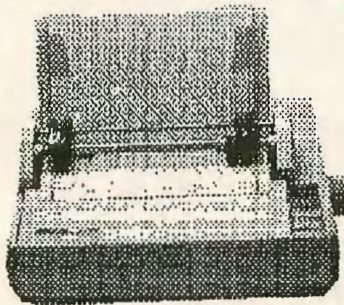
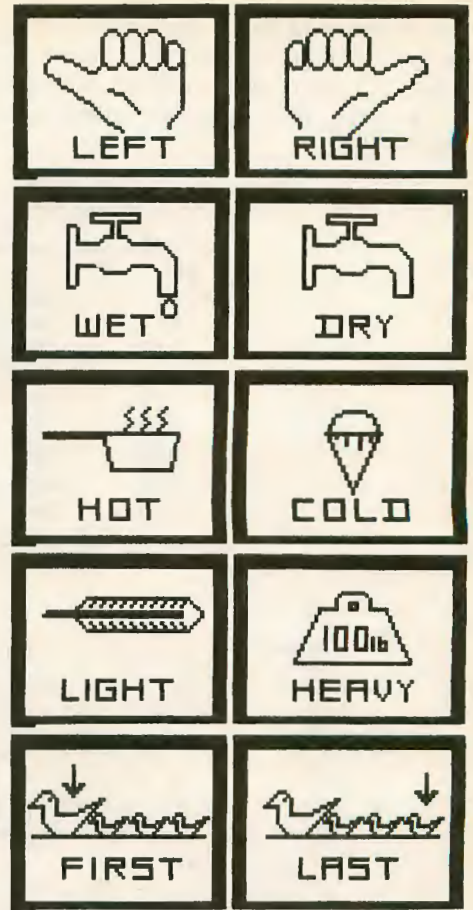

Hardware

- 2 Drive System(2 DSDD Drives in one case)*
\$329.95
- Drive 1 Upgrade(1 DSDD for your 26-3129 or 3131) Specify Catalog# when ordering !!
\$119.95
- Drive 0-SSDD Full Height* \$209.95
- Drive 1-SSDD Full Height \$135.95
- COCO 3 512K Upgrade \$219.95
- COCO 3 Keyboard \$34.95

COCO ACCESSORIES

Epson LX-800
Printer
\$219.95

180 CPS - DRAFT
30 CPS - NLD
3K BUFFER
REQUIRES SERIAL TO PARALLEL INTERFACE

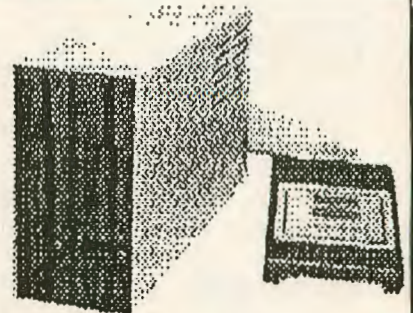

Software & Misc.

- Art Deli(448 Pix on 10 disks) \$99.95
- COCO Graphics Designer \$29.95
- ADOS - \$29.95 ADOS 3 - \$39.95
- Serial to Parallel Converters \$54.95
- FKEYS III - \$19.95 Sixdrive - \$19.95
- Telewriter 64 - \$59.95 COCO-Utl1 - \$39.95
- Gauntlet - \$28.95 Pyramix - \$24.95
- Disto Super Controller \$99.95
- COCO in Stitch (X-Stitch Patterns)- \$3.95

*Specify R.S. or Disto Controller.

ALL DISK DRIVES
CARRY A 90 DAY
WARRANTY.

The Computer Center

5512 Poplar Ave. Memphis, TN 38119 901-761-4565

Add \$4.98 For Shipping & Handling. VISA, Master Card, & Money Orders Accepted. Allow 3 Weeks for personal checks, NO CODS. Prices may change without notice.

IF YOU DON'T SEE
IT, ASK US !



the screen will flash and let you try again. If you are correct, the screen will show the correct pair and then move on to the next choice after you press the ENTER key.

In the text-only quiz, you must select

the correct response — 1, 2 or 3. You will get only one try on each term. The screen will indicate if you are correct or incorrect.

As you can tell from the program's title, there will be an *Opposites Vol. 2*

very soon. It will cover somewhat more difficult concepts than this first version. However, next month I'll have the game I have been promising you for months, and it will have a great deal to do with what we have covered this month. □

45153	57568
85152	610157
14560	655109
21536	7052
32581	750201
39065	83573
450180	94015
490176	END213
530140		

The listing: OPOSITE1

```

1 REM*****
2 REM* OPPOSITE CONCEPTS VOL.1 *
3 REM*   COPYRIGHT (C) 1988   *
4 REM*   BY FRED B. SCERBO   *
5 REM*   60 HARDING AVENUE   *
6 REM*   NORTH ADAMS, MA 01247 *
7 REM*****
10 CLEAR3000
15 CLS0:PRINTSTRING$(32,188);STR
ING$(32,156);:FORI=1TO 256 :READ
A:PRINTCHR$(A+128);:NEXT
20 PRINTSTRING$(32,195);STRING$(
32,179);
25 PRINT@422," BY FRED B.SCERBO
";:PRINT@454," COPYRIGHT (C) 1
988 ";
30 DATA126,124,124,125,117,124,1
24,122,126,124,125,117,124,124,1
25,117,124,124,124,116,126,117,1
24,126,125,117,124,124,117,124,1
24,124
35 DATA122,,,117,117,115,115,122
,123,115,119,117,,,117,117,115,1
15,115,,122,,,122,,117,115,114,1
17,115,115,115
40 DATA122,,,117,117,,,,122,,,11
7,,,117,,,,117,,122,,,122,,117,,
,,,117
45 DATA124,124,124,124,116,,,32,
120,,,116,124,124,124,116,124,12
4,124,116,124,,116,124,,116,124,
124,116,124,124,124
50 DATA46,44,44,45,37,,,32,42,,,
37,44,44,45,36,44,44,45,36,46,,3
6,46,32,37,44,44,36,44,44,45
55 DATA42,,,37,37,35,35,34,43,35
,35,37,,,37,33,35,35,39,,42,,,42
,,,37,35,34,33,35,35,39
60 DATA42,,,37,37,,,42,42,,37,37
,,,37,37,32,,,42,33,32,42,33,37
,,,37,,,

```

```

65 DATA44,44,44,44,36,44,44,40,4
4,44,44,36,44,44,44,36,44,44,44,
36,44,36,44,44,44,36,44,44,36,44
,44,44
70 X$=INKEY$:IFX$<>CHR$(13) THEN7
0
75 DIM P$(20,2),A$(6),B$(20),C$(
20),A(20),N(20),B(4),C(4),D(4),E
(4),F(4),AO(20)
80 FORI=1TO3:READ C(I),D(I),E(I)
,F(I):NEXT:FORI=1TO6:READA$(I):N
EXT:FORI=1TO20:READP$(I,1),B$(I)
,P$(I,2),C$(I):NEXT
85 COLOR1,0:P$(8,2)=P$(8,1):P$(8
,1)=P$(8,1)+"BU28BR4F6NU16NE6U2N
H4NE4BD36BL6NR10D4NR10D6BR18NU10
BR8U10R10D4L10R4F6BR6R10U6L10U4R
10BR6R6ND10R6"
90 P$(8,2)=P$(8,2)+"BU24BR74F6NU
16NE6U2NH4NE4BD42BL74NU10R8BR6U6
NR10U4R10D10BR6R10U6L10U4R10BR6R
6ND10R6"
95 CLS:PRINTSTRING$(32,"=");:PRI
NT@68,"OPPOSITE CONCEPTS VOL.1":
PRINT@134,"A) REVIEW ALL TERMS":
PRINT@198,"B) QUIZ GRAPHICS":PRI
NT@262,"C) QUIZ TERMS ONLY"
100 PRINT@324,"<<<SELECT YOUR CH
OICE>>>"
105 PRINT:PRINTSTRING$(32,"=");:
PRINT@420,"DEDICATED TO THE STUD
ENTS":PRINTTAB(8)"OF JOHNSON SCH
OOL"
110 X$=INKEY$:X=RND(-TIMER):IFX$
="A"THEN365ELSEIFX$="B"THEN115EL
SEIFX$="C"THEN795ELSE110
115 CLS0:Pmode0,1:PCLs1
120 LINE(0,0)-(254,170),PRESET,B
125 LINE(6,4)-(122,82),PRESET,BF
130 LINE(128,4)-(248,82),PRESET,
B
135 LINE(6,86)-(122,164),PRESET,
B
140 LINE(128,86)-(248,164),PRESE
T,B
145 DRAW"BM26,188C0NU10R10NU10BR
6R10U6L10U4R10BR6NR10D4NR10D6R10
BR12BU6NE4D2F4BR6R10U6L10U4R10BR
6ND10R10D4NL10BR6NR10D6U10R10D10
BR6NR10U10R10BR6NR10D4NR10D6R10B
R10U10NL4R10D4NL10D6NL14BR6U10R1
0D4NL10D6BR6U10R10D4L10R4F6BR6E4
U2H4"
150 DATA130,6,246,80,6,86,120,16

```



```

2,130,86,246,162
155 PAINT(2,2),0,0:PCOPY1TO3
160 PMODE0,4:PCLS1
165 LINE(0,0)-(254,170),PRESET,B
F
170 LINE(8,6)-(120,80),PSET,BF
175 PCOPY4TO2:PMODE0,1:SCREEN1,1
180 DATA"BM2,8C1","BM130,8C0","B
M2,90C0","BM130,90C0","BM2,48C0"
,"BM130,48C0"
185 FORI=1TO20
190 A(I)=RND(20):IFN(A(I))=1THEN
190
195 N(A(I))=1:NEXTI:FORY=1TO20:C
OLOR1,0
200 FORI=2TO4
205 B(I)=RND(3)+1:IFN(B(I))=0THE
N205
210 N(B(I))=0:NEXTI:FORI=1TO4:N(
I)=1:NEXT
215 B=RND(20):IFB=A((Y))THEN215
220 C=RND(20):IFC=B OR C=A((Y))T
HEN220
225 DRAW A$(1):DRAWP$(A(Y),1)
230 DRAW A$(B(2)):DRAWP$(B,2)
235 DRAW A$(B(3)):DRAWP$(C,2)
240 DRAW A$(B(4)):DRAWP$(A(Y),2)
245 COLOR1,0
250 Z=0

```

```

255 PMODE0,4
260 DRAW A$(1)+"C0":DRAWP$(A(Y),
1)
265 DRAW A$(B(2)+"C1":DRAWP$(B,
2)
270 DRAW A$(B(3)+"C1":DRAWP$(C,
2)
275 DRAW A$(B(4)+"C1":DRAWP$(A(
Y),2)
280 PMODE0,1:SCREEN1,1
285 LINE(8,6)-(120,80),PSET,B
290 X$=INKEY$:IFX$="" THEN300ELS
EIFX$="@ THEN965
295 COLOR1,0:LINE(8,6)-(120,80),
PRESET,B:GOTO285
300 Z=Z+1:IFZ=4THENZ=1
305 COLOR1,0:LINE(C(Z),D(Z))-(E(
Z),F(Z)),PSET,B
310 X$=INKEY$:IFX$="" THEN300ELS
EIFX$=CHR$(13) THEN320ELSEIFX$="@
 THEN965
315 COLOR1,0:LINE(C(Z),D(Z))-(E(
Z),F(Z)),PRESET,B:GOTO305
320 IFZ+1=B(4) THEN330
325 NW=NW+1:FORK=1TO5:PMODE0,4:S
CREEN1,1:SOUND10,3:PMODE0,1:SCRE
EN1,1:SOUND1,3:NEXTK:GOTO305
330 NC=NC+1:PMODE0,4:PCLS1:LINE(
0,40)-(256,126),PRESET,B:LINE(6,

```

INTRODUCING THE WARGAME DESIGNER



TAKE COMMAND! Now you can create your own 1 & 2 player wargames and more. If you are into wargames, science fiction or Dungeons and dragons, you'll love the WGD system.

The completely menu driven system allows you to create your own full color Hi-res icons for units and map features. Take control of the number of units, strength, movement, turn of entry, range of fire, terrain modifiers and objectives. No programming required! WGD comes with a 23 page manual and 2 floppy diskettes in a rigid vinyl case with these four ready to play scenarios:

INVASION NORTH	a river crossing challenge
ATTACK ON MOSCOW	a historic simulation 1941
ROBOT COMMAND	a si-fi thriller
DUNGEON WARRIOR	save the damsel in distress



Complete WGD system ONLY \$29.00 Each scenario available separately with WGD system demo for ONLY \$10.00.
COCO 3 128K Disk

GRIDIRON STRATEGY



The FIRST and still the BEST 2 player football strategy game for the COCO 3 128K disk.

Over 20 offensive plays and 10 defensive alignments. See the RAINBOW review 8/87. '...fascinating.' Totally unique playing system!

Disk, manual and playing aids only \$21.00.



\$\$\$\$\$\$\$\$\$ WEEKLY WINNER 2.0 \$\$\$\$\$\$\$\$

A graphics oriented PROVEN WINNER! Features statistical analysis, intuition and luck. Manual contains little known facts about winning number characteristics. Works with all state lotteries. all number combinations.

'I won \$90.00 the first time I used it.' KJO, OH
ONLY \$10.00

Orders shipped first class FREE within 24 hrs. of receipt.

SPORTSware 1251 S. Reynolds Rd., Suite 414, Toledo, OH 43615



(419) 389-1515



Files Edit Run Compile Options

To Assembly .a
To Object .r
To Executa e
Cancel

OS9 Programming Tools

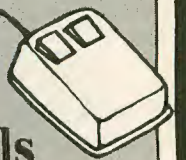

• CCENV® PROGRAMMING ENVIRONMENT

CCENV is a mouse-and-menu driver for all OS9 compilers and assemblers. CCENV is interactive and easy to use. A single mouse-click can take a C program from source code to executable module and then run the program in a window. Colorful pull-down menus, popup menus and dialog boxes set all compiler, assembler, and linker options. Temporary files are automatically written on the RAMdisk if available, reducing compile-time. Go from edit mode to compile and back to edit with mouse-clicks. Error messages are saved and can be scrolled in a window during your next editing session.

CCENV maintains configuration files so all options can be rechosen automatically. A PROJECT option implements the MAKE utility, allowing large projects to be split into separate modules until linking. Coupled with CCENV, any OS9 compiler becomes interactive and brisk. You can throw away "CC1." Move over, Turbo C! This is the way programming should be!

CCENV OS9 COMPILER/ASSEMBLER ENVIRONMENT\$49.95
with source code\$99.95
Requires OS9 Level II, mouse, and any compiler or assembler.
Preset for the MicroWare C Compiler.

• FUNCTION LIBRARIES

C GRAPHICS LIBRARY: The complete CGFX graphics library in C
source code and relocatable modules\$19.95
C MATH LIBRARY:\$19.95
BASIC09 FORMAT\$ 9.95 Both\$24.95
BASIC09 MOUSE & MENU LIBRARY: Create mouse-driven applications with pulldown menus
from BASIC09. Includes UNDERSTANDABLE directions for using mice
and menus in OS9. \$14.95

(509)

(please add \$2.50 S/H) 783-5132

* FoxWare 5101 W. 12th Kennewick, WA 99337 *

```

44)-(124,122),PRESET,B:LINE(130,
44)-(248,122),PRESET,B:PAINT(2,4
2),0,0
335 DRAW A$(5):DRAWP$(A(Y),1)
340 DRAW A$(6):DRAWP$(A(Y),2)
345 SCREEN1,1
350 X$=INKEY$:IFX$<>CHR$(13)THEN
350
355 PMODE0,1
360 PCOPY3TO1:SCREEN1,1:PCOPY2TO
4:NEXTY:GOTO965
365 PMODE0,2:PCLS1:SCREEN1,1:LIN
E(0,40)-(256,126),PRESET,B:LINE(
6,44)-(124,122),PRESET,B:LINE(13
0,44)-(248,122),PRESET,B:PAINT(2
,42),0,0
370 FORI=1TO20:DRAW A$(5):DRAWP$
(I,1)
375 DRAW A$(6):DRAWP$(I,2)
380 X$=INKEY$:IFX$<>CHR$(13)THEN
380
385 COLOR1,0:LINE(8,46)-(122,120
),PSET,BF:LINE(132,46)-(246,120)
,PSET,BF:NEXTI
390 RUN
395 DATA"BR60BD4F20L10D24L20U24L
10E20BD52BL14D10R10U10BR8ND10R10
D6L10"
400 DATA UP
405 DATA"BR60BD4L10D24L10F20E20L
10U24L10BD52BL32R4ND10R10D10L14B
R20U10R10D10NL10BR6NU10R6NU8R6NU
10BR6U10F10U10"
410 DATA DOWN
415 DATA"BR16BD20R80M-4,+20L36M-
4,-18NL36BR12BU4E4UH4UE4BR10G4DF
4DG4BR10E4UH4UE4BD50BL50D10U6R10
U4D10BR8U10R10D10NL10BR12U10L6R1
2"
420 DATA HOT
425 DATA"BR60BD20L4ND6L6ND2L4ND4
L2M+16,+32M+16,-32L16R4ND8R6ND4R
6L2U4H2U2H2L2H2L12G2L2G2D2G2D4BD
36BL10L10D10R10BR8U10R10D10NL10B
R8NU10R10BR6R14U10L14R4D10"
430 DATA COLD
435 DATA"BR10BD14R26F4D16G4L22NU
24D24L4R26E4U16H4BR12U24NL4NR4D4
8NL4R4BR10H4U40E4R16F4D10BD10NL1
6D20G4L14BR24R4U30R4U10R2U10E2U6
RD6F2D10R2D10R4D30R4L22BR8BU2U24
BR4D24"
440 DATA BIG
445 DATA"BR38BD56D8R4BR4U8BR4R2N
D8R2BR4R2ND8R2BR4D8R4BR4NR4U4NR4
U4NR4BU6BL6H4L4U2NR4D2L4NUND4L4U
2L4D2R4NH6L2G4"
450 DATA LITTLE
455 DATA"BR24BD36E12G6F20R20E20F
6H12BL14H2G4L4H4G2BU10BL4NU4L2U6
E4R2BR26L2G4D6L2U4BD56BL46U10D4R

```

```

10U4D10BR6U10NR10D4R10U4D10BR6U1
0R10D4L10D6BR16U10R10D4L10BR18BD
6U6NH4NE4"
460 DATA HAPPY
465 DATA"BR34BD50H12F6E12R36F12G
6E12BU16BL28H2G4L4H4G2BU10BL4NU4
L2U6E4R2BR26L2G4D6L2U4BD58BL34R1
0U6L10U4R10BR6NR10D4NR10D6BR10NU
10BR6R4U10L4R14D10L10"
470 DATA SAD
475 DATA"BR20BD22D20M+30,+10NU20
R50U20NL50M-30,-10ND8L50M+30,+10
M-30,-10E20R50G20L10NE20L10NE20L
10NE20L10NE20BD34BR6NR10D10R10NU
10BR6U10R6D4L6D6BR12NR6U6NR6U4R6
BR6ND10F10U10"
480 DATA OPEN
485 DATA"BR12BD16D20M+30,+10NU20
R60U20NL60M-30,-10L60M+30,+10R12
M-30,-10R12M+30,+10R12M-30,-10R1
2M+30,+10BD40BL78NR10U10R10BD10B
R6NU10R8BR6U10R10D10NL10BR6R10U6
L10U4R10BR6NR6D4NR6D6R6BR6R4NU10
R10U10L14"
490 DATA CLOSED
495 DATA"BR90BD52U2E8U32H4L4G2D1
0F2R4E4BL12U12H4L4G4D12F4R4E4BL1
2U12H4L4G4D12F4R4E4BL12U12H4L4G4
D12F4R4E4BL12D2G4L4M-10,-6M-10,-
2L2G4D4M+8,+4D2M+20,+12F10M+6,+2
F2BE10H10M-8,-3BD36BL20NU10R10BR
6NR8U6NR8U4R8BR6NR10D4NR10D6BR22
U10L6R12"
500 DATA LEFT
505 DATA"BR28BD52U2H8U32E4R4F2D1
0G2L4H4BR12U12E4R4F4D12G4L4H4BR1
2U12E4R4F4D12G4L4H4BR12U12E4R4F4
D12G4L4H4BR12D2F4R4M+10,-6M+10,-
2R2F4D4M-8,+4D2M-20,+12G14G2BH10
E10M+8,-3BD24BL40ND10R10D4L10R4F
6BR6NU10BR6U10NR10D10R10U6NL4BR6
NU4ND6R10U4D10BR10U10L6R1
510 DATA RIGHT
515 DATA"BR30BD6D34R4E2U10R12F4R
12E4R12F4D12R10U20H8L18H4L4U8R12
U4L28D4R12D8L4G4L12U8H2L4BM+60,+
40F4D4G2L4H2U4E4BL54BD10D10R6NU8
R6NU10BR6NR8U6NR8U4R8BR6R6ND10R6
"
520 DATA WET
525 DATA"BR30BD6D34R4E2U10R12F4R
12E4R12F4D12R10U20H8L18H4L4U8R12
U4L28D4R12D8L4G4L12U8H2L4BD50BR8
R4ND10R10D10NL14BR6U10R10D4L10R4
F6BR10U6NH4E4"
530 DATA DRY
535 DATA"BR10BD40R102L8E10M-8,+4
L6U4H2L2G4R4D4F4L20E10M-8,+4L6U4
H2L2G4R4D4F4L20E10M-8,+4L6U4H2L2
G4R4D4F4L20E20M-16,+8L12U8H4L4G8
R8BE4NLBG4D8F8"

```

540 DATA FIRST
 545 DATA BR2
 550 DATA LAST
 555 DATA"BR56BD26M+18,+5F8LH2L2G
 2H2L2G2H2L2G2H2L2G3D11GLNHREU11H
 3L2G2H2L2G2H2L2G2H2L2G2E8M+18,-5
 BU10R10E4NH4R6E4U2H4L10G4L12NG4H
 6L8G4D6F4R6F4R4E2R2R6R4BR16NE6NR
 20NF6BD50BL50U10R10D10NL10BR6BU4
 NU6F4E4U6BR6NR10D4NR10D6R10BR6U1
 0R8D4L6F6"
 560 DATA OVER
 565 DATA"BR56BD2M+18,+5F8LH2L2G2
 H2L2G2H2L2G2H2L2G3D9GLNHREU9H3L2
 G2H2L2G2H2L2G2H2L2G2E8M+18,-5BD3
 6NE6NH6NG6NF6BR16NE6NF6R22BD28BL
 74NU10R10NU10BR6U10F10NU10BR6R4U
 10L4R14D10NL10BR6NR10U6NR10U4R10
 BR6ND10R8D4L8R2F6"
 570 DATA UNDER
 575 DATA"BR16BD20E2NR80R16E8R6NG
 4R6NG4R6NG4R6NG4R6NG4R6NG4NG4R6N
 G4R6NG4R6NG4R6NG4F8D2G8NH4L6NH4L
 6NH4L6NH4L6NH4L6NH4L6NH4L6NH4L6N
 H4L6NH4L6H8L16NR80BD46BR10NU10R8
 BR6NU10BR6U10R10BD4NL4D6NL10BR6U
 6NU4R10U4D10BR12U10L6R12"
 580 DATA LIGHT
 585 DATA"BR26BD46R68M-14,-30L10U
 6H4L12G4D6L10M-14,+30BR18BU8U12B
 R6NR6D12R6NU12BR6U12R6D12NL6BR4N
 U6BR4NU6U4R4D4L4BU22BL14L4U4R4D4
 BD50BL36U10D4R10U4D10BR6NR10U6NR
 10U4R10BR6ND10R10D4NL10D6BR6BU4N
 U6F4E4U6BR6F4ND6E4"
 590 DATA HEAVY
 595 DATA"BR60BD48R8E4U10R4U6L4U6
 H4L16G4D6L4D6R4D10F4R8BU6NE4NH4B
 U8NLNR2BU6BL4NR2BR6R2BU16R6E2H2L
 20G2F2R12BD20BL20H16D16F16R36E16
 U16G16BD34BL50U10R10BD4NL4D6NL10
 BR6U10R10D10NL10BR6U10R10D10NL10
 BR6R4NR10U10L4R14D10"
 600 DATA GOOD
 605 DATA"BR60BD48R8E4U10R4U6L4U6
 H4L16G4D6L4D6R4D10F4R8BU10NG4NF4
 BU4NLNR2BU6BL4NR2BR6R2BU12E6D8L2
 0U8F6BL20D6G4L6NU10ND20L6H4U6BR7
 8NG4NF4D20G10BD20BL48U10R10D4NL1
 0D6NL10BR6U6NR10U4R10D10BR6R4NR1
 0U10L4R14D10"
 610 DATA BAD
 615 DATA"BR20BD16D30NR56U30R6U16
 R10F4G4L10D8R10D6R10D6R10D6R10D6
 R10D6R26BU42BL30L20NE4NF4BD52BL2
 0D10U6R10U4D10BR8NU10BR8NR10U10R
 10BD4NL4D6BR6U10D4R10U4D10"
 620 DATA HIGH
 625 DATA"BR20BD16D30NR56U30R16D6
 R10D6R10D6R10D6R10D6R26L16U16R10
 F4G4L10D8BU26BR6NU16NH4NE4BD46BL

50NU10R8BR6U10R10D10NL10BR6NU10R
 6NU8R6U10"
 630 DATA LOW
 635 DATA"BR32BD26NR50D2NR50D2R50
 D6L2D4R14U4L2U12H2U4H2U2H4L6D2F2
 D2F2D8BL50BD30D4ND6R10D6U10BR6ND
 10R10D4NL10D6BR6U10R10D4L10R4F6B
 R6R4NU10R10U10L14"
 640 DATA HARD
 645 DATA"BR36BD18H8U8R8F8E4R20F4
 E8R8D8G8D10G4D2G8L2G4L8H4L2H8U2H
 4U10BR10BD4R4NU2ND2NR4NE2NH2BR12
 R4NU2ND2NR4NE2NH2BG8BD4NE4NH4D6N
 F4NG4U6BR6NR20BL12NL20BR6D4BF4NF
 10BH4BG4G10BL14BD14R10U6L10U4R10
 BR6ND10R10D10NL10BR6U6NR10U4R10B
 R6R6ND10R6"
 650 DATA SOFT
 655 DATA"BR30BD2D10NR30D4NR30L2D
 4L2D4L2D4L2D12NR88D6R8NU6R8NU6R8
 NU6R8NU6R8NU6R8NU6R8NU6R8NU6R8NU
 6R8NU6R8U6U4H4M-10,-4L4ND10M-30,
 -10NU16NE6D4M+30,+10BL58ND8NH8BD
 22BR16ND10R10D10NL10BR6U10F10U10
 "
 660 DATA ON
 665 DATA"BR26BD2D14L2D4L2D4L2D4L
 2D12F6R20E2R30F2R14E2F2R10E2U6H2
 L10H2L8M-30,-10H4U18BL18BD20G4D4
 F4BD20D10R10U10NL10BR6NR10D4NR10
 D6BR16U6NR10U4R10"
 670 DATA OFF
 675 DATA"BR20BD6ND20R80G10NL50M+
 10,+30G4L62H4M+10,-30H4L8D14L6BD
 30BR16NR10D4NR10D6BR16NU10R10NU1
 0BR6NU10R8BR4NU10R8"
 680 DATA FULL
 685 DATA"BR20BD6ND20R80G10M+10,+
 30G4L62H4M+10,-30H4L8D14L6BD30NR
 10D4NR10D6R10BR6U10R6ND6R6D10BR6
 U10R10D4NL10BR6BU4R6ND10R6BR6F4N
 D6E4"
 690 DATA EMPTY
 695 DATA"BR50BD14ND20R12D10NL12N
 D10BR8R6NU6ND6R6BR10U18L60D36R60
 U18BD30BL60NL4ND10R10D4NL10D6NL1
 4BR6NR10U6NR10U4R10BR6BD10R10U6L

PREMIUM COCO3 512K UPGRADE

- Made in USA by J&R Electronics
- Memory chips socketed, user replaceable
- Rugged, long life construction
- Top mounted Memory for cooling
- Heavy duty POWER and GROUND planes to minimize memory errors due to noise
- High performance design, permits use of less expensive 150ns memory chips
- We supply Prime memory chips, not inferior pulls or fallouts*
- Includes RAMDISK, Spooler and Memory Test software on disk with 28 page User's Manual (We set the standard for 512K support software. We believe our software is uniquely powerful, as opposed to those "Me, too" companies that charge extra for software with much less power!)

SPECIAL PRICES

#1010-29.95 JramR bare board plus connectors and software
 #1014-39.95 JramR assembled & tested OK (No memory chips) and software
 *CALL (for latest price of #1014 with memory chips and other products)
 To place an order, write to: J&R Electronics, P.O. Box 2572, Columbia, MD 21045,
 OR call (301) 987-9067-Jesse or (301) 788-0861-Ray

```

10U4R10BR6R6ND10R6"
700 DATA BEST
705 DATA"BR50BD14ND20R12BD10NL12
BR8R12BR10U18L60D36R60U18BD30BL7
0D10R6NU8R6U10BR6ND10R10D10NL10B
R6U10R10D4L10R4F6BR6R10U6L10U4R1
0BR6R6ND10R6"
710 DATA WORST
715 DATA"BR30BD4ND6R60D6NL60D4L6
0NU4G4D28F4R60E4U28H4BL20BD32H4L
4U2NR4D2L4NUND4L4U2L4D2R4NH6L2G4
BD10BL26ND10BR6ND10F10U10BR6BD10
R10U6L10U4R10BR6ND10BR6R4ND10R10
D10NL14BR6NR10U6NR10U4R10"
720 DATA INSIDE
725 DATA"BR12BD4ND6R60D6NL60D4L6
0NU4G4D28F4R60E4U28H4BR36BD32H4L
4U2NR4D2L4NUND4L4U2L4D2R4NH6L2G4
BD10BL76ND10R10D10NL10BR6NU10R10
U10BR6R6ND10R6BR6BD10R10U6L10U4R
10BR6ND10BR6R4ND10R10D10NL14BR6N
R8U6NR8U4R8"
730 DATA OUTSIDE
735 DATA"BR16BD30NR30U2NR30U2R18
BR4R2BR4R2BL30U2R90G12M-48,+4U10
BD36BL22R10U6L10U4R10BR6D10U6R10
U4D10BR6U10R10D4NL10D6BR6U10R10D
4L10R4F6BR6U10R10D4L10"
740 DATA SHARP
745 DATA"BR16BD30NR40H2U4E2R40ND
8R48F2D2G2L2G2L2G2L36H2BD36BL28R
4NU10R10U10NL14BR6D10R10U10BR6D1
0R8BR6NU10R8"
750 DATA DULL
755 DATA"BR22BD6R30D6F4R8E4U6R30
D16L8NU16L8D26L22NU30L22U26L8NU1
6L8U16BD60NR10U10R10BR6D10R8BR6N
R10U6NR10U4R10BR6ND10R10D4NL10D6
BR6U10F10U10"
760 DATA CLEAN
765 DATA"BR22BD6R30D6F4R8E4U6R30
D16L8NU16L8D26L8NU12L4NU20L2NU8L
4NU6L4NU30L8NU12L4NU20L2NU8L4NU6
L2NU18L2U26L8NU16L8U16BD50R4ND10
R10D10NL14BR8NU10BR8U10R10D4L10R
4F6BR6BU10R6ND10R6BR6F4ND6E4"
770 DATA DIRTY
775 DATA"BR20BD30NR84BD36BL6R10U
6L10U4R10BR6ND10R6ND8R6D10BR6U10
R10D10NL10BR6U10R10D10NL10BR6BU1
0R6ND10R6BR6D10U6R10U4D10"
780 DATA SMOOTH
785 DATA"BR14BD30BRE4R4F4R4E4R4F
4R4E4R4F4R4E4R4F4R4E4R4F4R4E4R4F
4BL84BD36U10R10D4L10R4F6BR6U10R1
0D10NL10BR6NU10R10NU10BR6U10R10B
D4NL4D6NL10BR6U10D4R10U4D10"
790 DATA ROUGH
795 CLS:V=1
800 FORI=1TO20

```

```

805 AO(I)=RND(20)
810 IF N(AO(I))=1 THEN 805
815 N(AO(I))=1:NEXTI
820 FOR P=1TO20
825 CLS
830 PRINT@68,"WHAT IS THE OPPOSI
TE OF"
835 PRINT@132,C$(AO(P))+ " ?"
840 FOR Q=1TO2
845 C(Q)=RND(20):IF C(Q)=AO(P) T
HEN845
850 FOR K=Q-1 TO 0STEP-1:IF C(K)
=C(Q) THEN845
855 NEXTK
860 NEXTQ:C(3)=AO(P)
865 FOR E=1TO3
870 F(E)=RND(3)
875 FOR K=E-1 TO 0STEP-1:IF F(K)
)=F(E) THEN870
880 NEXTK:NEXTE
885 PRINT
890 PRINTTAB(8)"1-"+B$(C(F(1))):
PRINT
895 PRINTTAB(8)"2-"+B$(C(F(2))):
PRINT
900 PRINTTAB(8)"3-"+B$(C(F(3))):
PRINT
905 G$=INKEY$:IFG$="@"THEN965
910 IF G$=""THEN905
915 G=VAL(G$)
920 IF G<1 THEN 905
925 IF G>5 THEN 905
930 IF C(F(G))<>AO(P) THEN945
935 PRINT:PRINT" RIGHT! THE ANS
WER IS: "+B$(AO(P))
940 NC=NC+1:GOTO955
945 PRINT:PRINT" SORRY! THE AN
SWER IS: "+B$(AO(P))
950 NW=NW+1
955 X$=INKEY$:IFX$<>CHR$(13)THEN
955
960 NEXT P
965 CLS:PRINT@101,"YOU TRIED"NC+
NW"TIMES &":PRINT@165,"ANSWERED"
NC"CORRECTLY"
970 PRINT@229,"WHILE DOING"NW"WR
ONG."
975 NQ=NC+NW:IF NQ=0THEN NQ=1
980 MS=INT(NC/NQ*100)
985 PRINT@293,"YOUR SCORE IS"MS"
%."
990 PRINT@357,"ANOTHER TRY (Y/N/
C) ?";
995 X$=INKEY$:IFX$="Y"THEN RUN
1000 IFX$="N"THENCLS:END
1005 IFX$="C"THEN1015
1010 GOTO995
1015 IFV=1THEN825
1020 IFV=0THEN280

```

Now from NRI comes the first course of its kind . . . anywhere!

Learn to use, program, and service today's digital electronic music equipment as you build your own computer-controlled music center



Now NRI puts you at the heart of the most exciting application of digital technology to date! With NRI's new at-home training in Electronic Music Technology, you get hands-on experience with the equipment that's revolutionizing the music industry—Atari ST Series computer with built-in MIDI ports, Casio CZ101 digital synthesizer with advanced MIDI capabilities, and ingenious MIDI software that links computer keyboard to synthesizer keyboard—all yours to train with and keep.

This year, over \$1.5 billion worth of digital electronic music instruments—keyboards, guitars, drum machines, and related equipment—will be sold in the U.S. alone. Who's buying this new-tech equipment? Not just progressive musicians and professional recording technicians, but also thousands of people who have never touched a musical instrument before. And there's good reason why.

Something called MIDI (Musical Instrument Digital Interface) has suddenly transformed musical instruments into the ultimate computer peripherals . . . and opened up a whole new world of opportunity for the person who knows how to use, program, and service this extraordinary new digital equipment.

Now NRI's breakthrough Electronic Music Technology course puts you at the forefront of this booming new technology with exclusive hands-on training built around a MIDI-equipped computer, MIDI synthesizer, and MIDI software you keep.

Dynamic New Technology Opens Up New Career Opportunities for You

The opportunities are unlimited for the person who's trained to take advantage of today's electronic music phenomenon. Now you can prepare for a high-paying career as a studio technician,

sound engineer, recording engineer, or road technician . . . even start your own new-age business providing one-stop sales and service for musicians, technicians, and general consumers alike. Or simply unleash your own musical creativity with the breakthrough training and equipment only NRI gives you.

Only NRI Gives You an Atari ST Computer, Casio Synthesizer, and Innovative MIDI Software You Train With and Keep

The Atari ST Series computer included in your course becomes the heart of your own computer-controlled music center. With its tremendous power, superior graphics capabilities, and built-in MIDI interface, the 16/32-bit Atari ST has almost overnight become the computer of choice for today's most knowledgeable electronic musicians.

The Casio CZ101 digital synthesizer, also included in your training, is the perfect complement to your Atari ST. The polyphonic, multitimbral CZ101—which stores up to 32 voices internally—"communicates" with your ST computer through MIDI, bringing life to virtually any sound you can imagine.

Plus, you get ingeniously designed MIDI software that opens up amazing new creative and technical possibilities . . . you actually build your own 4-input audio mixer/amplifier . . . and you test the electronic circuits at the core of today's new-tech equipment with the hand-held digital multi-meter included in your course.

No previous experience necessary—in electronics or music!

No matter what your background, NRI gives you the skills you need

to take advantage of today's opportunities in electronic music technology.

With your experienced NRI instructor always available to help, you master the basics of electronic theory step by step, gaining the full understanding of electronics that's now so essential for technicians and musicians alike. You move on to analyze sound generation techniques, digital logic, microprocessor fundamentals, and sampling and recording techniques . . . ultimately getting first-hand experience with today's explosive new technology as you explore MIDI, waveshaping, patching, sequencing, mixing, special effects, and much more.

Plus, even if you've never been involved with music before, NRI gives you enough basic training in music theory and musical notation to appreciate the creative potential and far-reaching applications of today's electronic music equipment.

Send Today for Your FREE Catalog

For all the details about NRI's innovative new training, send the coupon today. You'll receive a complete catalog describing NRI's Electronic Music Technology course plus NRI courses in other high-tech, in-demand electronics fields.

If the coupon is missing, write to NRI School of Electronics, McGraw-Hill Continuing Education Center, 3939 Wisconsin Avenue, Washington, DC 20016.

NRI School of Electronics McGraw-Hill Continuing Education Center

3939 Wisconsin Avenue
Washington, DC 20016



For Career courses
approved under GI Bill
 check for details.

CHECK ONE FREE CATALOG ONLY

- Electronic Music Technology Computers and Microprocessors
 TV/Video/Audio Servicing Basic Electronics

Name _____ (Please Print) _____ Age _____

Street _____

City _____ State _____ Zip _____

Accredited by the Accrediting Commission of the National Home Study Council #205-088



A routine to convert a machine language program into BASIC

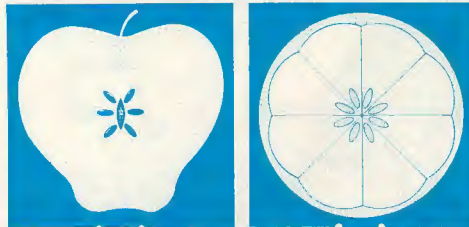

ML-DATA

By Stephen Miller

Many times I get programs that try in vain to load a machine language subroutine program, or my favorite picture needs two or three disks in order to dump it to the printer.

I worked out a routine to take an ML program in memory and convert it into BASIC DATA lines that can be added to a program and keep the entire kit together. I was doing some experiments with the saving of ASCII files when it became apparent that this mixing of apples and oranges could in fact be done.

Before loading the program, type in and enter CLEAR size and address for the ML program. Then load *ML-Data* and run it. The opening prompts will again ask you for the CLEAR parameters and the filename for the ML subroutine you want to transfer. Remember to use &H for the address. You will also be asked for the "line number to return to." After the BASIC program created by *ML-Data* pokes in its ML code, it has to know where to go in your BASIC program. Then the program will load the ML package and ask you for the start and end addresses for the ML program. The

Stephen Miller is an electronics hobbyist who enjoys hardware-hacking on his CoCo 2 and 3. He was one of the first CoCo 3 owners in Canada.

program will open a data file on disk, then send out to the disk the READ and POKE information to reconstruct your ML routine later. Sit back and watch the fun.

The program will look in memory at the ML program and assign the HEX notation found to A\$. Once 70 bytes have been accumulated, A\$ will be dumped to the disk and reset, and the program will continue to build the next DATA line number. All along, you will be able to view the complete line number and present addresses flashing by. Once it reaches the end address, the program will close the file and indicate that the job is done.

Now load in your BASIC program where you want the *ML-Data* package to go. Make sure you have room above Line 10000. Now enter MERGE "DATA-FILE". This program will then create a new Line 0 to clear the memory for the ML routine. When this is done, call up a list. When you're ready to use your ML package, use the EXEC&Hxxx command where needed. You could also use the DEFUSR command if information is needed between BASIC and ML.

A simple little routine to save a lot of time, fingers, eyes and late hours!

(Questions or comments concerning this program may be directed to the author at P.O. Box 5000, Penetanguishene, Ontario, Canada L0K 1P0. Please enclose an SASE when requesting a reply.) □

The listing: ML-DATA

```

1 '*****
2 '*      STEPHEN MILLER      *
3 '*      P.O.BOX 5000      *
4 '* PENETANGUISHENE,  ONTARIO *
5 '* CANADA                L0K 1P0 *
6 '*****
10 CLEAR700
20 CLS:PRINT" THIS PROGRAM WILL
TAKE A M/L  PROGRAM IN MEMORY,
AND CREATE A BASIC 'DATA' FILE F
OR A LOADER  ROUTINE YOU CAN ADD
INTO A BASICPROGRAM.  THE DATA
FILE WILL USELINE '0',AND LINES
10000 AND UP.
30 INPUT"HOW MUCH STRING SPACE T
O CLEAR ";CL:PRINT"USE HEX VALUE
S AND USE '&H'":INPUT"CLEAR AT W
HAT ADDRESS ";CL$:INPUT"WHAT LIN
E NUMBER TO RETURN TO ";LN
40 INPUT"enter M/L FILENAME: ";N
$:LOADMN$
50 PRINT:INPUT"enter START ADDRE
SS OF M/L IN  MEMORY: ";ST:PRIN
T:INPUT"enter ENDING ADDRESS OF
M/L IN  MEMORY: ";EN
60 Y=10001

```

```

70 OPEN"O",#1,"DATAFILE.BAS"
80 CLS:A$="0 CLEAR"+STR$(CL)+"",
+CL$+":GOTO10000":PRINTA$:PRINT#
1,A$:A$="10000 FORADD=&H"+HEX$(S
T)+" TO&H"+HEX$(EN)+" :READINF$:P
OKEADD,VAL("+CHR$(34)+"&H"+CHR$(
34)+" +INF$):NEXT:GOTO"+STR$(LN):
PRINTA$:PRINT#1,A$
90 A$="DATA "
100 FORT=ST TOEN:Z=Z+1:IFZ=>70TH
ENGOSUB130
110 D$=HEX$(PEEK(T)):A$=A$+D$+",
":NEXT:GOSUB130
120 CLOSE:PRINT@392,"finished: &
H"HEX$(T-1):END
130 A$=LEFT$(A$,LEN(A$)-1):A$=ST
R$(Y)+" "+A$:A$=RIGHT$(A$,LEN(A$
)-1):Y=Y+1
140 CLS:PRINT@32,A$:PRINT@392,"a
ddress: &H"HEX$(T)
150 PRINT#1,A$
160 Z=0:A$="DATA ":RETURN

```



Handicappers

FOOTBALL: Looking for a quick, easy way to handicap NFL games? Then you need Pigskin Predictions, our bestselling NFL handicapper. No struggling with meaningless statistics! Easy once-a-week entry of scores. Predicts point spreads, displays schedule by week or team, shows real or projected standings at any point in the season. Seven different reports to screen or printer. Seeing this one is believing! Runs on any CoCo with 32K and a disk drive. Only \$39.95

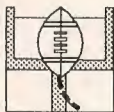

RACING: Use your Color Computer to improve your performance at the track! Handicappers for **Thoroughbreds, Harness Horses and Greyhounds** quickly rank the contestants in each race, even if you've never handicapped before. All the information you need is readily available in the track program or *Racing Form*. Thousands of satisfied customers since 1983! Thoroughbred, Harness or Greyhound handicappers, only \$39.95 each. Runs on any CoCo, tape or disk.

Federal Hill Software
8134 Scotts Level Road
Baltimore, Md. 21208
Info 301-521-4886

Visa-MC Welcome
Toll Free Orders
800-628-2828 Ext. 850

NEW, LOW PRICES! SAVE 40% TO 33%



MONEY-BACK GUARANTEE!
COMPATIBLE WITH COCO 3!

SCREENPRINTS ON ANY PRINTER!!

Picture Perfect

GRAPHIC SCREENPRINT PROGRAM
FULL-PAGE PRINTOUTS WITH-

RADIO SHACK: LPVII, LPVIII, DMP100, DMP105, DMP106, DMP110
DMP120, DMP130, DMP130A, DMP200, DMP430, CGP220.

EPSON/IBM: ALL COMPATIBLE PRINTERS - MX/RX/FX/EX/LX/LQ
SERIES, STAR GEMINI 10X/15X, NX10/15, NX1000.

AND: ZENITH MP199, NORTH ATLANTIC QANTEX, BROTHER
DM-40, CANON INK-JET, PANASONIC, C-110H AND
LEADING EDGE PROWRITER, OLIVETTI INK-JET,
TOSHIBA, OKIDATA, GORILLA BANANA, AND MORE!!

ONLY \$15.00 (US) ON DISK OR TAPE

TURN DATA INTO ARTWORK WITH-

LOADS SPREADSHEETS
AUTO SCALES & LABELS
SMOOTHS & INTEGRATES
291 GRAPHING SYMBOLS
UNLIMITED OVERLAYS
STORE COMPLETE GRAPHS
MANUAL & TUTORIAL

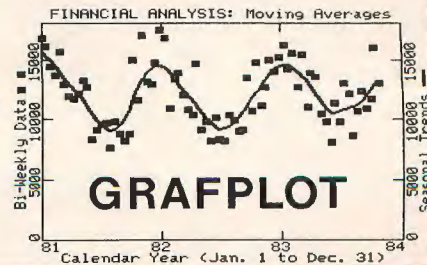

GRAF PLOT

SPECIFY PRINTER
WITH YOUR ORDER!

TAPE: \$25.00 (US)
DISK: \$30.00 (US)

SEND CHECK OR MONEY ORDER TO:

HAWKES RESEARCH SERVICES: 859 STANFORD AVE, OAKLAND, CA 94608
FOR INFORMATION - (415) 547-7557. SHIPMENT WITHIN 48 HOURS!
ADD \$3.00 SHIPPING ON ALL ORDERS. CA. RESIDENTS ADD SALES TAX



Create great games and Simulations
in CoCo's own language

The Little Graphics Library

By Kevin Dowd

There's nothing like the speed of machine language graphics! In this article I'll show you building blocks and a method for creating fast, high-quality assembly language games and Simulations.

Think of the screen as a stage. We will

Kevin Dowd is a technical support analyst with Multiflow Computer, Inc. He bought his first Color Computer in 1982 and hasn't gone to bed on time since.

decide who the players will be, perhaps meteors and spaceships or mice in a maze. We'll decide how they should interact (i.e. what happens if a mouse encounters a spaceship). In general, however, we'll keep loose control, allowing our players to move freely within the restrictions we choose. We could even play, too. The important thing is that we are going to let the players drive the program, rather than let the program drive the players.

You'll need an assembler and familiarity with the 6809 assembly language, the machine language of your Color Computer. We'll explore a number of programs and incrementally build on a library of subroutines. I will tell you about the new routines as we use them, so you needn't have them all keyed in to get started.

To write any graphics game we'll need to be able to move and monitor objects on the screen. Let's start at the very beginning with a method for drawing a picture, independent of giving it movement.

Statics

Let me introduce something I call *The Little Graphics Language (LGL)*. Picture the screen as a piece of graph paper; imagine that you are going to draw something in a pattern of neighboring squares, one at a time. In each step you are allowed to color in the square where you are and/or move to another, vertically, horizontally or diagonally. This completely describes the procedure for programming with

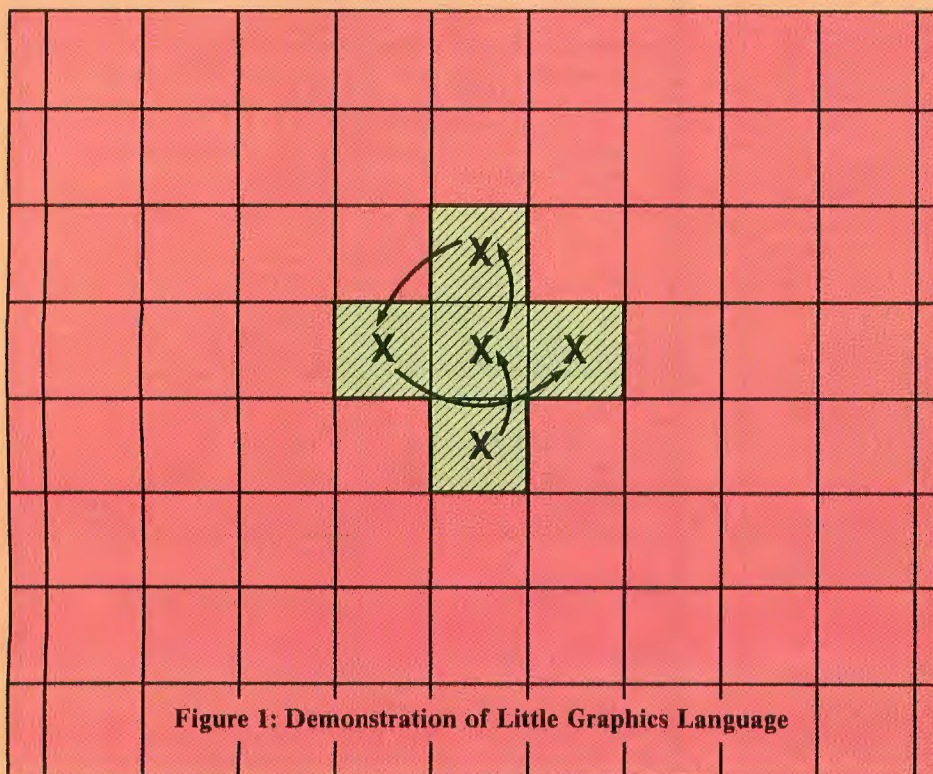

Figure 1: Demonstration of Little Graphics Language

LGL. The drawing in Figure 1 and the following example show how to construct a blue plus sign three pixels wide and three pixels high:

```
BLUEUP write a blue pixel, move
        cursor up
BLUEUP write a blue pixel, move
        cursor up
BLUEDL write a blue pixel, move
        down and left
BLUERT write a blue pixel, move
        right
RIGHT  move right
BLUE   write a blue pixel
DONE
```

We drew three blue pixels vertically, moved down and to the left and drew another, and then moved right two pixels and drew a final blue pixel. Be sure to note that first we draw and then we move. I will be referring to pictures we have drawn with *LGL* as "shapes."

PROG1	\$6B00	\$6E71	\$6B00
PROG2	\$6B00	\$6E9D	\$6B00
PROG3	\$6B00	\$6EAB	\$6B00
PROG4	\$6B00	\$71A0	\$6B00

Table 1: Final Start, End and Execute addresses for PROG1 through PROG4 when assembled with LIBRARY.

Having described how it's constructed, we can draw this shape on the screen; first, however, we have to choose where it will be drawn. Any screen location will suffice as long as it's between the first possible location (Pixel 0) and the last (Pixel 12287 for the graphics mode I've chosen). Pixels are numbered starting with 0 at the

upper left of the screen and progressing to the right until they wrap around on the next line.

"To write any graphics game we'll need to be able to move and monitor objects on the screen."

The program shown in Listing 1 is for drawing the plus sign. It uses the subroutines VIDEO, VRAMCO, WRTSHP, NXTSET. At a minimum these routines must be included with PROG1, along with the tables listed at the end of the library (Listing 5). First, enter and save the code for Listing 5. Use the filename LIBRARY.ASM. Then type in Listing 1, and merge in LIBRARY.ASM according to your assembler, assembling the programs together. You will need to resave the binary file with the addresses shown in Table 1. Each of the listings 1 through 4 must be assembled with Listing 5 or parts of it, at least. You will need to leave out comments for Listing 4.

With PROG1 we make a major accomplishment: drawing our first "static" picture, following these important steps:

1) Pick a screen location and store it into SCRLOC (screen location), a varia-

ble representing the number of the pixel where the shape will be drawn.

2) Translate SCRLOC into actual video RAM coordinates with a call to VRAMCO. The CoCo allows you to reserve any part of memory for use as video RAM, the memory containing the picture on the screen. I've chosen to locate our video RAM starting at Location 29696, so whenever we talk about Screen Location 0 we are actually referring to Memory Location 29696. In fact, the first four pixels are packed into that first video RAM location.

VRAMCO generates two values called VLOC and VBIT. VLOC describes the pixel's address in RAM; since there is more than one pixel per byte, VBIT is used to describe which of the four possible pixels to use.

3) Put the address of PLSSGN into STSH (start of shape). STSH is read in the next step.

4) Call WRTSHP to draw the plus-sign on the screen. WRTSHP reads *LGL* instructions starting from the address stored in STSH until it reaches the DONE instruction.

5) Loop forever. Press the reset button to return control of your CoCo.

Dynamics

We could move the plus sign the way a cartoonist does, by repeatedly drawing it farther and farther off in one direction. But in our case we had better erase the character from its old location, lest we produce a smear. To this end, PROG1 can be modified to loop with a continuously changing value of SCRLOC. To move right, add a value of one each iteration. To move up or down, add or subtract a whole line at a time — 128 pixels. Perhaps we want a continuous diagonal movement. This quantity of movement is called a "vector", one of

Subroutine Summary

VIDEO — INPUTS: none
MODIFIES: CC,A,X.
OUTPUTS: none
For setting up video parameters, erasing the screen and the C-list.

VRAMCO — INPUTS: SCRLOC
MODIFIES: CC,D
OUTPUTS: VLOC, VBIT
Translates a screen location (pixel number) into actual video RAM coordinates. SCRLOC is usually set by the

programmer. The outputs, VLOC and VBIT, give the video RAM address and pixel number (0 to 3) at that address. These are never set by hand. This routine must be called before adding a character to the C-list or drawing a static shape on the screen.

WRTSHP — INPUTS: STSH, VLOC, VBIT
MODIFIES: CC,D,Y, video RAM, TLOC, TBIT
OUTPUTS: none

Draws a picture according to the *LGL* instructions at the memory address contained in STSH. The value of STSH is either set by hand or by a call to SHPADR. The placement of the shape on the screen is determined by the values in VLOC and VBIT. These are either set by VRAMCO or extracted from the C-list by GETLOC.

NXTSET — used internally. Updates the cursor position according to the *LGL* instructions.

ADDCHL — INPUTS: SHAPE, SCRLOC, AUX, VLOC, VBIT, VOUT

the qualities a "character" possesses in addition to its shape. Here's a sample vector for moving two pixels right and one pixel down:

$$\text{right} + \text{right} + \text{down} = 1 + 1 + 128 = 130$$

Byte #	Also known as	Purpose
0	XSHAPE	byte number identifying what type of character this is (i.e. mouse or spaceship?). It must be an even number.
1-2	XSCLOC	screen location where the character last moved.
3	XAUX	User-defined purpose.
4-5	XVLOC	Video RAM location corresponding to XSCLOC. It was generated by a call to VRAMCO.
6	XBIT	Pixel offset in XVLOC. Also generated by VRAMCO.
7-8	XVECT	Character's vector.

Figure 2

A character's new location can be calculated from its old location by adding the old location and the vector together.

If we set off hard-coding a loop to guide the movements of 100 characters, we'd soon find ourselves short on pa-

tience — not to mention program memory! More desirable is having some kind of method for handling a large number of characters in a uniform way. For that purpose I propose a character list, or C-list. The C-list is an area of memory we've reserved and divided into 100 little compartments, each containing information about the state of one active character. Updating the screen will be done by passing through the C-list and updating each entry. (Imagine this as a nursery with 100 cribs. The nurse looks into each in turn, skips the empty ones and attends to those with babies inside. In each of the programs we construct, we will include one "main loop" to pass through the C-list the same way the nurse checks over the cribs.)

The information stored in the C-list is necessary for tracking characters, i.e. vectors and video RAM locations. A list of the contents of each of the nine bytes of a single C-list entry is shown in Figure 2.

As a convention, any slot with a character number (XSHAPE) of zero is considered empty and can be subsequently filled in. Similarly, if we want to delete a character from the game, we simply set its C-list entry (XSHAPE) to zero.

It is very useful to have the addresses for the LGL routines all gathered into one area called a "shape table." That way, when we are stepping through the C-list and come across a character/shape number of 12, for example, we

can quickly look in the twelfth shape table entry to find out how Character 12 is drawn. In the next program the address of the LGL instructions for drawing the plus sign will live in the shape table at Location 2. (See Figure 3.)

The new routines required for PROG2 are ADDCHL, SHPADR, ANTISH, NEWLOC and PUTLOC. See the subroutine summaries for more information about what these routines do and what resources they use.

In PROG2 we used the C-list even though we were keeping track of only one character. With the framework we've already built, it is simple to add more characters — in fact, it requires only three lines!

```
00412 LDD #12B   Vector for
                "down"
00414 STD VOUT
00416 JSR ADDCHL Add another
                character
                to the list.
```

The plus signs are interesting, but you may have already noticed a serious shortcoming: They are oblivious to one another. What good is a game if the players don't interact? Furthermore, they are blind to their surroundings. If we drew a brick wall on the screen, they'd pass right through it! At the very least we want them to bump into each other. We might also want them to explode or wiggle a little.

How do we detect that we have

MODIFIES: CC,D,Y and the C-list.

OUTPUTS: none

This routine is for adding a character to the C-list. It steps through, looking for the first empty slot. If there are no empty slots nothing is added. SHAPE, usually set by the programmer, identifies the character by number. SCRLC, set by program or programmer, is the screen location where the character is to appear initially. The use and value of AUX is defined on a character-by-character basis. VLOC and VBIT are created by a call to VRAMCO. VRAMCO must be called after setting SCRLC and before calling ADDCHL. VOUT is the vector the character will have initially. It is set by the programmer or by RNDVEC or DIRVEC.

After ADDCHL has placed these values in the C-list, they can be retrieved by referring to

offsets from the X register. This table shows how the variables read by ADDCHL are associated with the C-list:

SHAPE	—	
XSHAPE	,X	shape or character number
SCRLC	—	
XSCLOC	,X	screen location or pixel number
AUX	—	
XAUX	,X	user defined
VLOC	—	
XVLOC	,X	video RAM location
VBIT	—	
XVBIT	,X	video RAM pixel offset
VOUT	—	
XVECT	,X	vector

SHPADR —INPUTS: A
MODIFIES: CC,Y,D
OUTPUTS: STSH

Takes the value in the A register as an offset into the shape table. The value of A must be even, and there must be a shape table entry corresponding to A. The output STSH is set to the address retrieved from the shape table. WRTSHP, ANTISH and OKMOV use STSH for drawing, erasing and checking for occurrences of other objects on the screen.

ANTISH —INPUTS: STSH, C-list values XVLOC, X and XVBIT, X
MODIFIES: CC,D,Y, video RAM, TLOC, TBIT
OUTPUTS: none
Erases a character from the screen. As a general rule, characters must always be erased before they are moved. When this routine is called, the X register must point into the C-list to the character you want to erase. STSH must have been set already with a call to SHPADR. The values XVLOC, X

bumped into something? Recall our algorithm for moving the plus signs:

- 1) Erase the old plus sign from screen
- 2) Calculate the new location for the plus sign by adding the vector to the old location
- 3) Write plus sign at the new location
- 4) Store the new location into the C-list

I propose we add some new operations between steps 2 and 3. Instead of immediately drawing the character at the new location, what if we first check the pixels where the shape is about to be written to see if anything is there already? If there is, we can skip this character and continue on to the next C-list entry. We might also want to generate a new — probably random — vector for the character, so that next time it heads in a different direction. Now we:

- 1) Erase the old plus sign from screen.
- 2) Calculate the new location for the plus sign by adding the vector to the old location.
- 2a) Check the new location to see if it's already occupied.
- 2b) If not occupied go to 3.
- 2c) Generate a random vector.
- 2d) Get the old location from the C-list.
- 2e) Redraw the character where it was before.
- 2f) Go to 5.

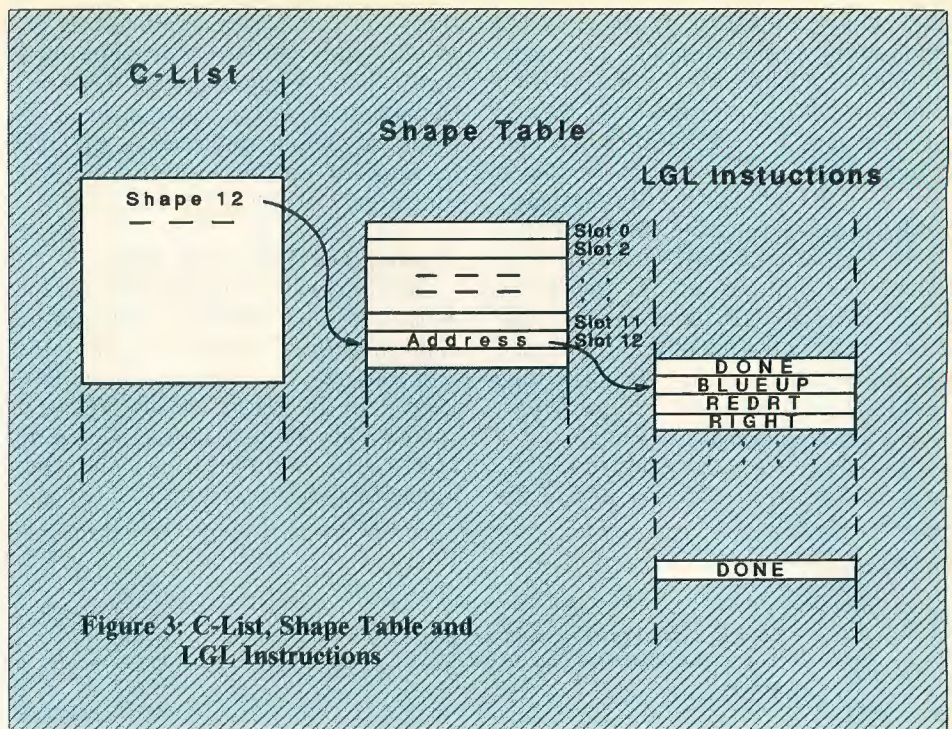

Figure 3: C-List, Shape Table and LGL Instructions

- 3) Write plus sign at the new location.
- 4) Store the new location into the C-list.
- 5) Continue stepping through C-list.

The program shown in Listing 3 illustrates these steps. It completely fills the C-list with swirling little white dots. The new routines we'll be using are OKMOV, RNDVEC and GETLOC.

Here are some interesting variations to PROG3:

- 1) Put up obstructions. First define a

barrier shape with LGL instructions (maybe bricks?), and place them about the screen the same way we drew the "static" plus sign in PROG1.

2) Fill the C-list with an assortment of objects. (Notice that if the shapes are too complex, they'll slow down the program, in which case you might want to half-fill the C-list.)

3) Multiply some of the vectors by two. (Shift the D register to the left.)

The next program makes full use of the subroutine library. First we'll draw a mountain range. Then we'll place one

and XVBIT, X are automatically retrieved.

NEWLOC —INPUTS: C-list values XSCLOC, X and XVECT, X
 MODIFIES: CC, D
 OUTPUTS: VL0C, VBIT, SCRLOC
 Calculates new screen location and video RAM address for the C-list character currently pointed to by the X register by adding the character's vector to its old location.

PUTLOC —INPUTS: VL0C, VBIT, SCRLOC
 MODIFIES: CC, D
 OUTPUTS: C-list values XVLOC, X, XVBIT, X, XSCLOC, X
 Stores screen location and video RAM address values into C-list entry pointed to X register. Usually done to update C-list after calling NEWLOC and successfully moving a character.

OKMOV — INPUTS: STSH, VL0C, VBIT
 MODIFIES: CC, D, Y, TBIT, TL0C
 OUTPUTS: the Z flag in the condition code.
 Traces out the LGL shape instructions whose address appears in STSH at the location given by VL0C and VBIT. If no pixels are found to be set (i.e. there is nothing there already) the Z flag is set, otherwise cleared. (If the Z flag is set, tests for zero will be true; for instance, a Branch On Equal (BEQ) instruction will branch.)

RNDVEC —INPUTS: none
 MODIFIES: CC, D, RND1, TVEC
 OUTPUTS: VOUT
 Generates a random vector with a maximum displacement of one pixel in any direction.

GETLOC —INPUTS: none
 MODIFIES: CC, D
 OUTPUTS: VBIT, VL0C
 Retrieves video RAM address where a character is drawn from the C-list. Usually called just after OKMOV has failed and before WRTSHP is called to restore the character to the screen.

BSTATE —INPUTS: none
 MODIFIES: CC, A
 OUTPUTS: BUTTON
 Checks to see if the fire button is pushed. Sets BUTTON if it is, clears it otherwise.

DIRVEC —INPUTS: TARGET, C-list XSCLOC, X
 MODIFIES: CC, D, TVEC
 OUTPUTS: VOUT
 Generates a vector toward the screen location that has been previously stored in TARGET. This is the routine used to guide the birds to the birdseed.

little man (controlled by the joystick) and four birds into the C-list. The object of the game will be for the man to jump onto one of the birds and fly to the top of the screen. The fire button will enable you to throw grains of bird seed, which are actually characters dynamically added and deleted from the C-list. The birds will swoop down toward the seed. Other new features include use of the XAUX byte of each character's C-list entry. XAUX will control the flapping of the birds' wings. As for the little man and the bird seed, XAUX will play a part in simulating gravity.

Yes, you can lose this game too! If the man falls from the back of one of the

birds, he can perish upon hitting the ground, depending on the height of the bird's flight. I haven't given too much thought to rewarding the player of the game, so anyone interested is welcome to finish it up. New subroutines this time are BSTATE and DIRVEC.

Loading and Assembling Files

For those with source on disk or tape: Since the four programs each use the same library of subroutines, the most efficient way to store the source is to keep it in five pieces. When you want to load the source, start first by loading one of the main routines and then appending the library. For *Disk ED-*

TASM users this is done with the LDA command. For those using the *ED-TASM+* ROM pack, two loads with the L command will append files automatically.

Disk EDTASM users will find that the first three programs can be assembled in memory with the /AO/IM switches if EDTASMDV is used. The fourth must be assembled to disk. ROM pack users can assemble any of the four programs directly in memory.

(Questions or comments concerning this tutorial may be directed to the author at 84 Round Hill Road, Wethersfield, CT 06109. Please enclose an SASE when requesting a reply.) □

Listing 1: PROG1

```

00010 *
00012 * Prog1 demonstrates how to choose
00014 * a screen address and draw a
00016 * shape.
00018 *
00100 DPVAL EQU $67 Using D.P. for speed
00110 STACK EQU DPVAL*256-1
00120 SETDP DPVAL
00130 ORG DPVAL*256+256
00140 START LDA #DPVAL
00150 TFR A,DP Set D.P. register
00160 LDS #STACK Move stack
00170 JSR VIDEO Init vid params
00180 *
00190 * CHOSE WHERE TO DRAW
00200 *
00210 LDD #6200 Center of screen
00220 STD SCRLOC Store for VRAMCO
00230 JSR VRAMCO Create ram addr
00240 LDD #PLSSGN Get addr of +
00250 STD STSH Store for WRTSHF

00260 JSR WRTSHF Write the shape
00270 LOOP BRA LOOP busy loop
00280 *
00290 * END OF MAN PROGRAM
00300 *
00302 * START OF SHAPE TABLE
00304 *
00306 SHTBL FDB 0
00308 *
00310 * START OF SHAPE DEFS
00320 *
00330 PLSSGN FCB BLUEUP
00340 FCB BLUEUP
00350 FCB BLUEDL
00360 FCB BLUERT
00370 FCB RIGHT
00380 FCB BLUE
00390 FCB DONE
00400 *
00410 * END OF CUSTOM CODE.
00420 * THE REST OF THIS STAYS
00430 * THE SAME.

```

Listing 2: PROG2

```

00100 *
00110 * Prog2 demonstrates animation
00120 * and use of the c-list for tracking
00130 * animated characters.
00140 *
00150 DPVAL EQU $67
00160 STACK EQU DPVAL*256-1
00170 SETDP DPVAL
00180 ORG DPVAL*256+256
00190 START LDA #DPVAL
00200 TFR A,DP
00210 LDS #STACK
00220 JSR VIDEO
00230 *
00240 * Going to add just one character
00250 * to the c-list. First set up params
00260 * for call to ADDCHL.
00270 *
00280 LDD #6200 Center of screen
00290 STD SCRLOC Store for VRAMCO
00300 JSR VRAMCO generate ram addr
00310 LDA #PLUS character # for +
00320 STA SHAPE store for addchl
00330 *
00340 * the value "130" is the vector we
00350 * chose to make the character move
00360 * right 2 pixels and down one in
00370 * each pass through the c-list.

00380 *
00390 LDD #130
00400 STD VOUT Vector for addchl
00410 JSR ADDCHL Add to c-list
00420 *
00430 LOOP LDX #IXSTRT Point to c-list
00440 CONT1 LEAX XNEXT,X Pt. next slot
00450 CMPX #CLEND End of c-list?
00460 BHS LOOP
00470 *
00480 * Stepping through c-list now.
00482 * We KNOW that there is only 1
00484 * entry being used in the c-list
00486 * but I wanted to show you how to
00488 * set up the loop anyway.
00490 * Get character's shape number.
00500 *
00510 LDA XSHAPE,X
00520 BEQ CONT1 Skip empties
00530 CMPA #PLUS
00540 BNE CONT1 Skip if not +
00550 *
00560 JSR SHPADR Get +'s shape
00570 JSR ANTISH Erase +
00580 JSR NEWLOC Add vctr to loc
00590 JSR WRTSHF Draw at new loc.
00600 JSR PUTLOC Put in c-list
00610 BRA CONT1
00620 *

```



```

00630 * END OF MAN PROGRAM
00640 *
00650 * START OF SHAPE TABLE
00652 * Note how the shape number for
00654 * "plus" has been symbolically
00656 * defined.
00660 *
00670 SHTBL FDB 0
00680 PLUS EQU *-SHTBL
00690 FDB PLSSGN
00700 *
00710 * START OF SHAPE DEFS
00720 *
00730 PLSSGN FCB BLUEUP
00740 FCB BLUEUP
00750 FCB BLUEDL
00760 FCB BLUERT
00770 FCB RIGHT
00780 FCB BLUE
00790 FCB DONE
00800 *
00810 * END OF CUSTOM CODE.
00820 * THE REST OF THIS STAYS
00830 * THE SAME.

```

Listing 3: PROG3

```

00100 *
00110 * Prog3 demonstrates how to make
00120 * objects on the screen interact
00130 * with one another.
00150 *
00160 DPVAL EQU $67
00170 STACK EQU DPVAL*256-1
00180 SETDP DPVAL
00190 ORG DPVAL*256+256
00200 START LDA #DPVAL
00210 TFR A,DP
00220 LDS #STACK
00230 JSR VIDEO
00240 LDA #DOT Dot's shape #
00250 STA SHAPE For ADDCHL
00260 LOOP1 LDD #6200 Screen center
00270 STD SCRLOC For VRAMCO
00280 JSR VRAMCO Gen ram loc
00290 JSR RNDVEC Random vectr
00300 JSR ADDCHL add to c-list
00310 *
00320 * Note we are continually trying
00330 * to add new characters to the
00340 * c-list even though it'll be
00350 * stuffed full after the 1st 100.
00360 *
00370 CONT1 LDX #IXSTRT pt to c-list
00380 LOOP2 LEAX XNEXT,X pt next slot
00390 CMPX #CLEND end of c-list?
00400 BHS LOOP1
00410 *
00420 * Step through c-list
00430 *
00440 LDA XSHAPE,X
00450 BEQ LOOP2 Skip empties
00460 *
00470 * All characters will be handled the
00480 * same. You could fill the c-list with
00490 * any combination of dots, dashes,
00492 * or whatever...
00494 *
00500 JSR SHPADR
00510 JSR ANTISH erase char
00520 JSR NEWLOC Gen new loc
00530 JSR OKMOV Ok to move?
00540 BEQ ITSOK
00550 *
00560 * If something is already at the
00570 * place on the screen where we
00580 * want to go then pick a new
00590 * vector for next time and give up.
00600 *
00610 JSR RNDVEC random vectr
00620 LDD VOUT get result
00630 STD XVECT,X put in c-list
00640 JSR GETLOC get old loc
00650 JSR WRTSHP redraw there
00660 BRA LOOP2 Go do next
00670 *
00680 * If it was ok to move to the new
00690 * location then do it.
00700 *
00710 ITSOK JSR WRTSHP Draw at new
00720 JSR PUTLOC update c-list
00730 BRA LOOP2
00740 *
00750 * END OF MAIN PROGRAM
00760 *
00770 * START OF SHAPE TABLE
00780 *
00790 SHTBL FDB 0
00800 DOT EQU *-SHTBL
00810 FDB WHTDOT
00820 *
00830 * START OF SHAPE DEFS
00840 *
00850 WHTDOT FCB WHITE
00860 FCB DONE
00870 *
00880 * END OF CUSTOM CODE.
00890 * THE REST OF THIS STAYS
00900 * THE SAME.

```

Listing 4: PROG4

```

00100 *
00110 * Prog4 demonstrates full use of
00120 * the subroutine library.
00130 * The object of the game is to fly
00140 * to the top of the screen on the
00150 * back of one of the birds. If
00160 * you fall you may die. The joystick
00170 * fire button will cause you to
00180 * throw bird seed. This attracts
00190 * the birds so you can jump on
00200 * them.
00210 * - Kevin Dowd
00220 DPVAL EQU $67
00230 STACK EQU DPVAL*256-1
00240 SETDP DPVAL
00250 ORG DPVAL*256+256
00260 START LDA #DPVAL
00270 TFR A,DP
00280 LDS #STACK
00290 JSR VIDEO
00300 *
00310 * A mountain range will be created
00320 * by repeatedly drawing the shape
00330 * "MOUNTN" at the locations in the
00340 * list "MTLIST".
00350 *
00360 LDD #MOUNTN
00370 STD STSH
00380 LDX #MTLIST

```



```

00390 LOOP1 LDD ,X++
00400 BLT CONT1
00410 STD SCRLOC
00420 JSR VRAMCO
00430 JSR WRTSHP
00440 BRA LOOP1
00450 *
00460 * Now we will add the players to
00470 * the c-list, 1 man and 4 birds.
00480 *
00490 CONT1 LDD #6300
00500 STD SCRLOC
00510 JSR VRAMCO
00520 * ADD MAN
00530 CLR AUX
00540 LDA #MAN
00550 STA SHAPE
00560 CLR VOUT
00570 CLR VOU2
00580 CLR TMP3
00590 JSR ADDCHL
00600 * ADD BIRDS
00610 LDA #BIRD
00620 STA SHAPE
00630 LDD #6300
00640 STD SCRLOC
00650 JSR VRAMCO
00660 JSR RNDVEC
00670 LDA #04
00680 STA AUX
00690 STA TMP2
00700 LOOP3 DEC TMP2
00710 BLT LOOP2
00720 JSR ADDCHL
00730 BRA LOOP3
00740 *
00750 * This is the start of the main
00760 * loop. We'll check the joystick
00770 * and fire buttons. From the joy-
00780 * stic we'll make up a vector for
00790 * the little man to run along
00800 * the mountains.
00810 *
00820 LOOP2 JSR [$000A] chk joystk
00830 JSR BSTATE chk button
00840 LDX #IXSTRT pt c-list
00850 TST BUTTON button set?
00860 BEQ CONT2
00870 * If button was pushed will add
00880 * a grain of bird seed to the
00890 * clist.
00900 *
00910 LDA #SEED
00920 STA SHAPE
00930 *
00940 * The vector for the bird seed will
00950 * come from RNDVEC. Then we'll add
00960 * an upward displacement so
00970 * it'll be as if the man threw it
00980 * over his head.
00990 *
01000 JSR RNDVEC
01010 LDD VOUT
01020 ADDD #FFF80
01030 STD VOUT
01040 *
01050 * CH1LOC is a kludge. It's the
01060 * address of the screen loc of the
01070 * first character in the c-list
01080 * (in this case, the little man).
01090 * Bird seed will start just
01100 * above the man's head.
01110 *
01120 LDD CH1LOC
01130 ADDD #FFF80
01140 STD SCRLOC
01150 JSR VRAMCO
01160 CLR AUX
01170 JSR ADDCHL add seed
01180 CONT2 LEAX XNEXT,X
01190 CMPX #CLEND end c-list?
01200 BHS LOOP2
01210 LDA XSHAPE,X
01220 BEQ CONT2 skip empties
01230 CMPA #MAN
01240 LBGT CONT3
01250 *
01260 * The man is constantly running.
01270 * This is a function of the
01280 * value in tmp3.
01290 * The old and new shape number
01300 * being used to draw the man is
01310 * calculate from it.
01320 *
01330 LDA TMP3
01340 ANDA #01
01350 LSLA
01360 ADDA XSHAPE,X
01370 JSR SHPADR
01380 JSR ANTISH
01390 *
01400 * Man erased, get joystk.
01410 * Will generate a vector for the
01420 * man based on the pot values.
01430 *
01440 CLR VOUT
01450 CLR VOU2
01460 LDA $15B
01470 CMPA #00C
01480 BGT J01
01490 LDD #FFF80
01500 STD VOUT
01510 BRA J02
01520 J01 CMPA #33
01530 BLT J02
01540 LDD #080
01550 STD VOUT
01560 J02 LDA $15A
01570 CMPA #00C
01580 BGT J03
01590 LDD VOUT
01600 SUBD #01
01610 STD VOUT
01620 BRA J04
01630 J03 CMPA #33
01640 BLT J04
01650 LDD VOUT
01660 ADDD #01
01670 STD VOUT
01680 *
01690 * Next will use okmov to test to
01700 * see if the man could fall.
01710 * If he can will increase the
01720 * value in X,AUX, a counter to
01730 * tell how long his feet have
01731 * been off the ground. From this
01732 * we'll generate a number by
01733 * which we can bias his vector
01734 * and simulate gravity.
01735 *
01750 J04 LDD #080
01760 STD XVECT,X
01770 JSR NEWLOC
01780 JSR OKMOV Can he fall?
01790 BEQ CONT4
01800 *
01810 * Man can fall, so he will.
01820 *
01830 CLR XAUX,X
01840 CLRA
01850 CLR B
01851 *

```



```

01852 * GRVVEC will generate a gravity
01853 * vector based on the value of
01854 * X,AUX. If the man had his feet
01855 * on something then we have just
01856 * reset X,AUX and GRVVEC will
01857 * return a gravity bias of 0.
01858 *
01860 CONT4 JSR GRVVEC
01870 ADDD VOUT
01880 STD XVECT,X
01890 JSR NEWLOC
01900 JSR OKMOV
01910 BEQ CONT6
01920 *
01930 * Killed by a fall? If the man
01931 * had been able to move then
01932 * we wouldn't be here.
01933 *
01950 LDA XAUX,X
01960 CMPA #25
01970 LBGT YOUIDIE
01980 *
01990 * It could that he wasn't fall-
01991 * all that long, so we'll just
01992 * make him bounce a little by
01993 * generating a new vector for
01994 * him.
02000 *
02010 LDD #0
02020 STD GRAVITY
02030 CLR XAUX,X
02040 JSR RNDVEC
02050 LDD VOUT
02060 STD XVECT,X
02070 JSR NEWLOC
02080 JSR OKMOV
02090 BEQ CONT6
02100 *
02110 * Give up if couldn't move him.
02120 *
02130 JSR GETLOC
02140 JSR WRTSHP
02150 LBRA CONT2
02160 *
02161 * We were able to move the little
02162 * man by some path. Check his
02163 * screen location to see if we
02164 * won the game yet.
02165 *
02170 CONT6 LDD SCRLOC
02180 CMPD #280
02190 LBLE YOUWIN
02200 *
02210 INC TMP3
02220 LDA TMP3
02230 ANDA #01
02240 LSLA
02250 ADDA XSHAPE,X
02260 JSR SHPADR
02270 JSR WRTSHP
02280 JSR PUTLOC
02281 *
02282 * Now for the birds.
02283 *
02290 CONT3 CMPA #BIRD
02300 LBNE CONT8
02301 *
02302 * The birds flap their wings
02303 * based on the value of X,AUX.
02304 *
02340 LDA XAUX,X
02350 ANDA #02
02360 ADDA XSHAPE,X
02370 JSR SHPADR
02380 JSR ANTISH
02390 LDA XAUX,X
02400 BEQ BD4
02410 DECA
02420 ANDA #02
02430 BD4 ADDA XSHAPE,X
02440 JSR SHPADR
02450 TST BUTTON Pushed?
02460 BEQ BD1
02461 *
02462 * If the fire button was pushed
02463 * then the bird will head for
02464 * the last grain of bird seed
02465 * thrown. DIRVEC generates a
02466 * vector towards the screen loc
02467 * stored in TARGET.
02468 *
02470 JSR DIRVEC
02480 LDD VOUT
02490 STD XVECT,X
02500 BD1 JSR NEWLOC
02510 JSR OKMOV
02520 BEQ BD2
02521 *
02522 * If the bird bumps into some-
02523 * thing we'll not only generate
02524 * a new vector for it, we'll
02525 * also modify X,AUX so the wings
02526 * flap for a while.
02527 *
02530 JSR RNDVEC
02540 LDD VOUT
02550 STD XVECT,X
02560 JSR NEWLOC
02570 JSR OKMOV
02580 BEQ BD3
02590 JSR GETLOC
02600 LDA XAUX,X
02610 ANDA #02
02620 ADDA XSHAPE,X
02630 JSR SHPADR
02640 JSR WRTSHP
02650 LBRA CONT2
02660 BD3 LDA XAUX,X
02670 BEQ BD5
02680 ORA #32
02690 STA XAUX,X Flap
02700 BRA BD2
02710 BD5 LDA #33
02720 STA XAUX,X
02730 BD2 JSR WRTSHP
02740 JSR PUTLOC
02750 LDA XAUX,X
02760 LBEQ CONT2
02770 DEC XAUX,X
02780 LBRA CONT2
02790 *
02800 * Bird seed
02810 *
02820 CONT8 CMPA #SEED
02830 LBNE CONT2
02840 LDA XAUX,X
02850 ANDA #01
02860 LSLA
02870 ADDA XSHAPE,X
02880 JSR SHPADR
02890 JSR ANTISH
02891 * bird seed is also subject to
02892 * gravity. Whenever a grain of
02893 * bird seed bumps into something
02894 * it will be deleted from the
02895 * c-list
02896 *
02900 LDD XVECT,X
02910 PSHS D
02920 JSR GRVVEC
02930 ADDD XVECT,X
02940 STD XVECT,X

```

02950	LDA	XAUX,X	03620	FCB	BLUERT	04330	FDB	11706		
02960	ANDA	#01	03630	FCB	BLUERT	04340	FDB	11840		
02970	LSLA		03640	FCB	BLUERT	04350	FDB	12227		
02980	ADDA	XSHAPE,X	03650	FCB	BLUERT	04360	FDB	12236		
02990	JSR	SHPADR	03660	FCB	BLUERT	04370	FDB	12242		
03000	JSR	NEWLOC	03670	FCB	BLUERT	04380	FDB	11861		
03010	JSR	OKMOV	03680	FCB	BLUERT	04390	FDB	12248		
03020	BEQ	SD1	03690	FCB	BLUERT	04400	FDB	12253		
03030	PULS	D	03700	FCB	WHTUL	04410	FDB	12257		
03040	CLR	XSHAPE,X	03710	FCB	WHTLF	04420	FDB	11750		
03050	LBRA	CONT2	03720	FCB	BLUELF	04430	FDB	12265		
03060	SD1	JSR	WRTSHP	03730	FCB	BLUELF	FDB	12276		
03070	JSR	PUTLOC	03740	FCB	BLUELF	04450	FDB	10559		
03080	PULS	D	03750	FCB	BLUELF	04460	FDB	10946		
03090	STD	XVECT,X	03760	FCB	BLUELF	04470	FDB	11462		
03100	LDD	XSCLOC,X	03770	FCB	BLUELF	04480	FDB	12176		
03110	STD	TARGET	03780	FCB	BLUELF	04490	FDB	12166		
03120	LBRA	CONT2	03790	FCB	BLUELF	04500	FDB	11779		
03130	YOUIDIE	NOP	03800	FCB	BLUELF	04510	FDB	12160		
03140	YOUWIN	JSR	BSTATE	03810	FCB	BLUELF	FDB	\$\$\$\$		
03150	LDA	#200	03820	FCB	BLUELF	04530	MAN1	FCB	WHTDN	
03160	STA	65314	03830	FCB	WHTUR	04540	FCB	BLUELF		
03170	TST	BUTTON	03840	FCB	WHTRT	04550	FCB	REDDR		
03180	BEQ	YOUWIN	03850	FCB	BLUERT	04560	FCB	BLUEDL		
03190	LBRA	START	03860	FCB	BLUERT	04570	FCB	REDRT		
03191	*		03870	FCB	BLUERT	04580	FCB	BLKRT		
03192	*	GRRVEC is a helper function	03880	FCB	BLUERT	04590	FCB	REDUP		
03193	*	for this program only. It	03890	FCB	BLUERT	04600	FCB	UP		
03194	*	generates a number based on	03900	FCB	BLUERT	04610	FCB	RED		
03195	*	X,AUX which, when added to a	03910	FCB	BLUERT	04620	FCB	DONE		
03196	*	character's vector will sim-	03920	FCB	BLUERT	04630	MAN2	FCB	WHTDN	
03197	*	ulate gravity.	03930	FCB	BLUERT	04640	FCB	BLUELF		
03198	*		03940	FCB	WHTUL	04650	FCB	BLKDR		
03200	GRVVEC	LDA	XAUX,X	03950	FCB	WHTLF	04660	FCB	REDDL	
03210	CMPA	#100	03960	FCB	BLUELF	04670	FCB	BLKRT		
03220	BGT	G03	03970	FCB	BLUELF	04680	FCB	REDRT		
03230	INC	XAUX,X	03980	FCB	BLUELF	04690	FCB	BLKUP		
03240	CMPA	#03	03990	FCB	BLUELF	04700	FCB	UP		
03250	BGT	G01	04000	FCB	BLUELF	04710	FCB	BLACK		
03260	LDD	#0	04010	FCB	BLUELF	04720	FCB	DONE		
03270	BRA	G04	04020	FCB	BLUELF	04730	BIRD1	FCB	WHTUL	
03280	G01	CMPA	#05	04030	FCB	WHTUR	04740	FCB	LEFT	
03290	BGT	G02	04040	FCB	WHTRT	04750	FCB	LEFT		
03300	LDD	#\$80	04050	FCB	BLUERT	04760	FCB	LEFT		
03310	BRA	G04	04060	FCB	BLUERT	04770	FCB	WHTDR		
03320	G02	CMPA	#07	04070	FCB	BLUERT	04780	FCB	WHTDR	
03330	BGT	G03	04080	FCB	BLUERT	04790	FCB	REDRT		
03340	LDD	#\$100	04090	FCB	BLUERT	04800	FCB	REDRT		
03350	BRA	G04	04100	FCB	WHTUL	04810	FCB	RIGHT		
03360	G03	LDD	#\$180	04110	FCB	WHTLF	04820	FCB	REDRT	
03370	G04	RTS	04120	FCB	BLUELF	04830	FCB	REDUR		
03380	*		04130	FCB	BLUELF	04840	FCB	WHTUR		
03390	*	END OF MAIN PROGRAM	04140	FCB	BLUELF	04850	FCB	WHITE		
03400	*		04150	FCB	WHTUR	04860	FCB	DONE		
03410	*	START OF SHAPE TABLE	04160	FCB	WHTRT	04870	BIRD2	FCB	WHTDL	
03420	*		04170	FCB	BLUERT	04880	FCB	LEFT		
03430	SHTBL	FDB	0	04180	FCB	WHTUL	04890	FCB	LEFT	
03440	MAN	EQU	*-SHTBL	04190	FCB	WHITE	04900	FCB	LEFT	
03450	FDB	MAN1		04200	FCB	DONE	04910	FCB	WHTRT	
03460	FDB	MAN2		04210	*		04920	FCB	WHTRT	
03470	BIRD	EQU	*-SHTBL	04211	*	This is a list of screen	04930	FCB	REDRT	
03480	FDB	BIRD2		04212	*	locations where mountains	04940	FCB	REDRT	
03490	FDB	BIRD1		04213	*	are drawn.	04950	FCB	RIGHT	
03500	SEED	EQU	*-SHTBL	04214	*		04960	FCB	REDRT	
03510	FDB	SEED1		04220	MTLIST	FDB	12180	FCB	REDRT	
03520	FDB	SEED2		04230	FDB	11164	04980	FCB	WHTRT	
03530	*		04240	FDB	11672	04990	FCB	WHTRT		
03540	*	START OF SHAPE DEFS	04250	FDB	12188	05000	FCB	DONE		
03550	*		04260	FDB	11676	05010	SEED1	FCB	RED	
03560	MOUNTN	FCB	WHTRT	04270	FDB	11809	05020	FCB	DONE	
03570	FCB	BLUERT		04280	FDB	12199	05030	SEED2	FCB	BLUE
03580	FCB	BLUERT		04290	FDB	12210	05040	FCB	DONE	
03590	FCB	BLUERT		04300	FDB	11194	05050	*	END OF CUSTOM CODE	
03600	FCB	BLUERT		04310	FDB	11702	05060	*	THE REST OF THIS STAYS	
03610	FCB	BLUERT		04320	FDB	12218	05070	*	THE SAME.	

Listing 5:

```

06000 VIDEO EQU *
06010 *
06020 * THIS ROUTINE HAS REALLY
06030 * HARD PARAMETRS.
06040 *
06050 SCREEN EQU 29696
06060 SCREND EQU 32767
06070 STA 65478
06080 STA 65481
06090 STA 65482
06100 STA 65485
06110 STA 65487
06120 STA 65489
06130 STA 65472
06140 STA 65474
06150 STA 65477
06160 LDA #255
06170 STA 65314
06180 * CLEAR SREEN AND CLIST
06190 LDX #SCREEN
06200 XX1 CMPX #SCREND
06210 BHI XX2
06220 CLR ,X+
06230 BRA XX1
06240 XX2 LDX #CLIST
06250 XX3 CMPX #CLEND
06260 BGT XX4
06270 CLR ,X+
06280 BRA XX3
06290 XX4 RTS
06300 ADDCHL LDY #IXSTRT
06310 C90 LEAY XNEXT, Y
06320 CMPY #CLEND
06330 BGE C91
06340 TST XSHAPE, Y
06350 BNE C90
06360 LDA SHAPE
06370 STA XSHAPE, Y
06380 LDD SCRLOC
06390 STD XSCLOC, Y
06400 LDA AUX
06410 STA XAUX, Y
06420 LDD VLOC
06430 STD XVLOC, Y
06440 LDA VBIT
06450 STA XVBIT, Y
06460 LDD VOUT
06470 STD XVECT, Y
06480 C91 RTS
06490 *
06500 GETLOC LDA XVBIT, X
06510 STA VBIT
06520 LDD XVLOC, X
06530 STD VLOC
06540 RTS
06550 PUTLOC LDA VBIT
06560 STA XVBIT, X
06570 LDD VLOC
06580 STD XVLOC, X
06590 LDD SCRLOC
06600 STD XSCLOC, X
06610 RTS
06620 VRAMCO LDB SCRLO2
06630 ANDB #03
06640 STB VBIT
06650 LDD SCRLOC
06660 LSRB
06670 LSRA
06680 BCC CC1
06690 ADDB #80
06700 CC1 LSRB
06710 LSRA
06720 BCC CC2

```

```

06730 ADDB #80
06740 CC2 ADDB #SCREEN
06750 STD VLOC
06760 RTS
06770 *
06780 NXTSET LDA #20
06790 ANDA , Y
06800 BEQ C07
06810 DEC TBIT
06820 BGE C10
06830 LDA #03
06840 STA TBIT
06850 LDD TLOC
06860 SUBD #01
06870 STD TLOC
06880 BRA C10
06890 C07 LDA #10
06900 ANDA , Y
06910 BEQ C10
06920 INC TBIT
06930 LDA #04
06940 ANDA TBIT
06950 BEQ C10
06960 CLR TBIT
06970 LDD TLOC
06980 ADDB #01
06990 STD TLOC
07000 C10 LDA #08
07010 ANDA , Y
07020 BEQ C11
07030 LDD TLOC
07040 SUBD #32
07050 CMPD #SCREEN
07060 BGE C14
07070 ADDB #3072
07080 BRA C14
07090 C11 LDA #04
07100 ANDA , Y
07110 BEQ C09
07120 LDD TLOC
07130 ADDB #32
07140 CMPD #SCREND
07150 BLE C14
07160 SUBD #3072
07170 C14 STD TLOC
07180 C09 LEAY 1, Y
07190 RTS
07200 *
07210 NEWLOC LDD XSCLOC, X
07220 ADDB XVECT, X
07230 BGE C15
07240 ADDB #12288
07250 BRA C16
07260 C15 CMPD #12287
07270 BLE C16
07280 SUBD #12288
07290 C16 STD SCRLOC
07300 JSR VRAMCO
07310 RTS
07320 *
07330 WRTSHP LDD VLOC
07340 STD TLOC
07350 LDA VBIT
07360 STA TBIT
07370 LDY STSH
07380 C22 LDA , Y
07390 BGE C23
07400 RTS
07410 C23 TFR A, B
07420 ANDA #84
07430 BEQ C24
07440 ANDB #03
07450 LDA #03
07460 SUBA TBIT
07470 STA TMP2

```

PERRY COMPUTERS

The Ideal Buy

1-800-248-3823

TANDY COMPUTERS

Tandy 1000-HX 256K 1 Drive	535.00
Tandy 1000-TX 640K 1 Drive	860.00
Tandy 3000-HL 512K 1 Drive	1090.00
Tandy 3000 640K 1 Drive	1475.00
Tandy 4000 1 Meg 1 Drive	1890.00
Tandy 5000MC 2 Meg 1 Drive	4250.00
Tandy 5000MC 2 Meg 40 Meg	5525.00
Tandy 5000MC 2 Meg 84 Meg	5950.00
Tandy 1400LT 768K 2 Drives	1195.00
Tandy 102 24K	375.00
Tandy Color 3 128K	155.00

MONITORS & BOARDS

VM-4 Monochrome Green	95.00
VM-5 Monochrome Green	115.00
CM-5 Color RGB	220.00
CM-11 Color RGB	335.00
EGM-1 Color RGB (EGA)	510.00
VGM-100 Monochrome Analog	169.00
VGM-200 Color Analog	425.00
VGM-300 Color Analog	535.00
Tandy Dual Display Card	145.00
Tandy EGA Card	185.00
Paradise Basic EGA Card	135.00
Zucker Mono Graphics Card	72.00

DRIVES

Color Computer Drive 0	225.00
5 1/4" External Drive 1000EX	180.00
3 1/2" External Drive 1000EX	200.00
Tandy 20 Meg Hardcard	509.00
Tandy 40 Meg Hardcard	679.00
Zucker 30 Meg Hardcard	435.00
Seagate 20 Meg Hard Drive	265.00
Tandy 1000/SX/TX Controller	80.00

ZUCKER BOARDS

Zucker Serial Board	45.00
Zucker OK Memory Board 1000	47.00
Zucker MFB OK for 1000	106.00
Zucker 1200 Baud Modem Card	72.00

PRINTERS

DMP-106 Dot-Matrix	165.00
DMP-130 Dot-Matrix	255.00
DWP-230 Daisy Wheel	349.00
Epson LX-800 Dot-Matrix	205.00
Epson FX-86E Dot-Matrix	375.00
Epson FX-286E Dot-Matrix	475.00
Epson LQ-500 Dot-Matrix	375.00
Epson LQ-850 Dot-Matrix	579.00

Please write for complete price list.
We carry more items than listed here.

All prices and offers may be changed or withdrawn without notice. Advertised prices are cash prices. C.O.D. accepted add 2% (minimum charge \$10.00). M.C., Visa add 2%. All non defective items require return merchandise authorization. Call for RMA Number before returning. Delivery is subject to product availability. Add 1 1/2% for shipping and handling. \$5.00 minimum charge.

TM - Registered Trademark of Tandy, Epson, and IBM
Monday thru Friday 9am - 5pm EST.

PERRY COMPUTERS

124 South Main Street, Perry, MI 48872
CALL 1-517-625-4161 or TOLL-FREE
1-800-248-3823

07480	LDA	#03	08250	LDB	TARGET2	09020	CHLLOC	EQU	*+1
07490 C300	TST	TMP2	08260	ANDB	#\$7F	09030	CLIST	RMB	900
07500	BEQ	C301	08270	SUBB	TVEC	09040	CLEND	EQU	*-1
07510 C302	LSLA		08280	BNE	C82	09050	ZZZ	EQU	*
07520	LSLA		08290	RTS		09060	BLUEUP	EQU	\$49
07530	LSLB		08300 C82	BGT	C83	09070	BLUEUR	EQU	\$59
07540	LSLB		08310	LDD	VOUT	09080	BLUERT	EQU	\$51
07550	DEC	TMP2	08320	SUBD	#02	09090	BLUEDR	EQU	\$55
07560	BNE	C302	08330	STD	VOUT	09100	BLUEDN	EQU	\$45
07570 C301	COMA		08340	RTS		09110	BLUEDL	EQU	\$65
07580	ANDA	[TLOC]	08350 C83	LDD	VOUT	09120	BLUELF	EQU	\$61
07590	STA	[TLOC]	08360	ADDD	#02	09130	BLUEUL	EQU	\$69
07600	ORB	[TLOC]	08370	STD	VOUT	09140	BLUE	EQU	\$41
07610	STB	[TLOC]	08380	RTS		09150	REDUP	EQU	\$4A
07620 C24	JSR	NXTSET	08390 ANTISH	LDD	XVLOC,X	09160	REDUR	EQU	\$5A
07630	BRA	C22	08400	STD	TLOC	09170	REDRT	EQU	\$52
07640 *			08410	LDA	XVBIT,X	09180	REDDR	EQU	\$56
07650 SHPADR	TFR	A,B	08420	STA	TBIT	09190	REDDN	EQU	\$46
07660	CLRA		08430	LDY	STSH	09200	REDDL	EQU	\$66
07670	ADDD	#SHTBL	08440 C17	LDA	,Y	09210	REDLF	EQU	\$62
07680	TFR	D,Y	08450	BGE	C18	09220	REDUL	EQU	\$6A
07690	LDD	,Y	08460	RTS		09230	RED	EQU	\$42
07700	STD	STSH	08470 C18	ANDA	#\$40	09240	WHTUP	EQU	\$4B
07710	RTS		08480	BEQ	C19	09250	WHTUR	EQU	\$5B
07720 *			08490	LDA	#\$C0	09260	WHTRT	EQU	\$53
07730 RNDVEC	LDA	RND1	08500	LDB	TBIT	09270	WHTDR	EQU	\$57
07740	LDB	#243	08510	BEQ	C21	09280	WHTDN	EQU	\$47
07750	MUL		08520 C20	LSRA		09290	WHTDL	EQU	\$67
07760	ADDD	#01	08530	LSRA		09300	WHTLF	EQU	\$63
07770	ADDD	SCRLOC	08540	DECB		09310	WHTUL	EQU	\$6B
07780	STB	TVEC	08550	BNE	C20	09320	WHITE	EQU	\$43
07790	STB	RND1	08560 C21	COMA		09330	BLKUP	EQU	\$48
07800	TFR	B,A	08570	ANDA	[TLOC]	09340	BLKUR	EQU	\$58
07810	CLR	VOUT	08580	STA	[TLOC]	09350	BLKRT	EQU	\$50
07820	CLR	VOU2	08590 C19	JSR	NXTSET	09360	BLKDR	EQU	\$54
07830	ANDA	#01	08600	BRA	C17	09370	BLKDN	EQU	\$44
07840	BEQ	V01	08610 *			09380	BLKDL	EQU	\$64
07850	LDD	#\$FF80	08620 OKMOV	LDD	VLOC	09390	BLKLF	EQU	\$60
07860	STD	VOUT	08630	STD	TLOC	09400	BLKUL	EQU	\$68
07870	BRA	V02	08640	LDA	VBIT	09410	BLACK	EQU	\$40
07880 V01	LDA	TVEC	08650	STA	TBIT	09420	UP	EQU	\$08
07890	ANDA	#02	08660	LDY	STSH	09430	RIGHT	EQU	\$10
07900	BEQ	V02	08670 002	LDA	,Y	09440	DOWN	EQU	\$04
07910	LDD	#128	08680	BGE	003	09450	LEFT	EQU	\$20
07920	STD	VOUT	08690	LDA	#\$04	09460	DONE	EQU	\$\$\$
07930 V02	LDA	TVEC	08700	TFR	A,CC	09470 *			
07940	ANDA	#04	08710	RTS		09480 *	CLIST FIELD OFFSETS		
07950	BEQ	V03	08720 003	ANDA	#\$40	09490	XSHAPE	EQU	0
07960	LDD	VOUT	08730	BEQ	004	09500	XSCLOC	EQU	1
07970	SUBD	#01	08740	LDA	#\$C0	09510	XSCLO2	EQU	2
07980	STD	VOUT	08750	LDB	TBIT	09520	XAUX	EQU	3
07990	BRA	V04	08760	BEQ	005	09530	XVLOC	EQU	4
08000 V03	LDA	TVEC	08770 006	LSRA		09540	XVBIT	EQU	6
08010	ANDA	#\$08	08780	LSRA		09550	XVECT	EQU	7
08020	BEQ	V04	08790	DECB		09560	XNEXT	EQU	9
08030	LDD	VOUT	08800	BNE	006	09570	ORG		DPVAL*256
08040	ADDD	#01	08810 005	ANDA	[TLOC]	09580	TMP1	RMB	1
08050	STD	VOUT	08820	BEQ	004	09590	TMP2	RMB	1
08060 V04	LDD	VOUT	08830	CLRA		09600	TMP3	RMB	1
08070	BEQ	RNDVEC	08840	TFR	A,CC	09610	SCRLOC	RMB	1
08080	RTS		08850	RTS		09620	SCRLO2	RMB	1
08090 DIRVEC	LDD	XSCLOC,X	08860 004	JSR	NXTSET	09630	SHAPE	RMB	1
08100	ANDB	#\$80	08870	BRA	002	09640	VLOC	RMB	2
08110	STD	TVEC	08880 BSTATE	CLR	BUTTON	09650	VBIT	RMB	1
08120	LDD	TARGET	08890	LDA	65280	09660	TBIT	RMB	1
08130	ANDB	#\$80	08900	CMPA	#255	09670	TLOC	RMB	2
08140	SUBD	TVEC	08910	BEQ	NOTP	09680	VOUT	RMB	1
08150	CMPD	#0	08920	CMPA	#127	09690	VOU2	RMB	1
08160	BLE	C80	08930	BEQ	NOTP	09700	STSH	RMB	2
08170	LDD	#256	08940	INC	BUTTON	09710	TVEC	RMB	2
08180	BRA	C81	08950 NOTP	RTS		09720	RND1	RMB	1
08190 C80	BEQ	C81	08960	RTS		09730	AUX	RMB	1
08200	LDD	#\$FF00	08970 *			09740	GRAVITY	RMB	2
08210 C81	STD	VOUT	08980	* The following table should be					
08220	LDB	XSCLO2,X	08990	* included with each program.					
08230	ANDB	#\$7F	09000 *			09770	BUTTON	RMB	1
08240	STB	TVEC	09010 IXSTRT	EQU	*-9	09780	END		



The COCO hardware store



Fantastic Super Controller II

- Radio Shack/Tandy controller compatible.
- Works on all COCOs - 1, 2 or 3 with or without Multi-Pak Interface.
- One 24/28 pin socket for 8K ROM, 2764, or 27128 EPROM.
- Internal MINI-EXPANSION-BUS connector for one DISTO Super Add-On.
- Low Power draw; within COCO's requirements.
- Gold Plated edge connectors.
- Under OS-9:
 - Buffered Read/Write sector achieved without halting the CPU.
 - Continual use of keyboard even while reading or writing to disk.
 - System's clock no longer loses time during Read & Write.
 - NMI is blocked and transferred to IRQ in software for low CPU overhead.
 - Completely Interrupt driven for fast & smooth Multi-Tasking operations.
 - Drivers written by KEVIN DARLING

DISTO Super Controller I

\$99.95

A Superb Controller. Along with the included C-DOS, plug-in three more software selectable DOSes or 2764 or 27128 EPROMs burned to your liking.

The Internal Mini-Expansion-Bus lets you add some incredible features to the controller. Disto Super Add-Ons were designed to fit neatly inside the controller case.

\$130.

DISTO SUPER ADD-ONS

- **Real Time Clock & Printer Interface** **\$39.95**
Have the Real Time, Date and Year displayed on your screen at a simple command.
- **Mini EPROM Programmer** **\$54.95**
A LOW COST EPROM Programmer that attaches directly to any Disto Super Controller or MEB adapter to program those often used utilities.
- **Hard Disk Interface** **\$49.95**
A Hard Disk Interface fully compatible with SASI controller. Fits inside the Super Controller, Ramdisk or MEB Adapter. OS-9 drivers included. Also available with RS-232 Serial Port.
- **Super RAM 3 ZeroK Board** **\$CALL**
Now is the time to upgrade your COCO 3 to 512K of memory. Just add the memory chips and install in your COCO 3.
- **MEB Adapter** **\$24.95**
A Stand-Alone Mini-Expansion-Bus in which you can plug any other Disto Adapter directly in a Multi-Pak without the need for a Super Controller or Ramdisk.

DISTO NEW 3 in 1 Multi-Board Adapter

\$59.95

This Muti-Board is an adapter that plugs in any Disto Super Controller, Ramdisk or MEB Adapter.

It includes a new and improved Printer Port (Centronics compatible), a faster Real Time Clock (works at 2MHz.) and a true RS-232 Serial Port (external 12 volt AC adapter required). DB25 cable included.

It fits neatly inside the metal case and is still within Tandy's power limits. It also works with or without a Multi-Pak.

DISTO NEW RS-232 SuperPack

\$49.95

- A Stand-Alone (Multi-Pak required) adapter that gives the user a true RS-232 Serial Port.
- Completely compatible with OS9's ACIA software.
- Compatible with software that requires the Tandy Deluxe RS-232 Pack.
- DB-25 cable included.

CRC COMPUTERS INC.



4 in 1 Super Board

Coming this fall to a dealer near you

Real Time Clock, Printer Port, RS-232 & Hard Disk Interface all in one neat package

10802 Lajeunesse, Montreal, Quebec, Canada H3L 2E8

1-514-383-5293

We accept phone orders • Call for Canadian Prices
Include S&H of \$4 or \$8 if order exceeds \$75

Master Card and Visa Accepted

Sorry: No personal cheques

*Simplify and organize Adventure
playing without ruining the fun*

Adventure Game Mapping Techniques

By John Dillon

Adventure games can perhaps be defined as logical puzzles involving people in unusual situations. Using this definition, it is fair to say that Adventures have been with us for generations. Over a hundred years ago Sam Loyd was delighting readers with hundreds of situations that required careful thought and mapmaking ability. Even a traditional detective story is an adventure — the reader wanders through an assortment of rooms, finding clues and trying to figure out “who done it” and where the treasure is hidden.

However, in a novel the reader has no control over the detective’s words or action — the reader is a purely passive player. (The term “player” was chosen over “spectator” because a well-written novel will get the reader more involved than merely spectating.)

Our current concept of Adventure games overcomes the passivity of literary adventures. No longer must a player watch in frustration as the hero drinks a fluid that *everyone* knows is poison — now the player can shatter the vial instead, realizing too late that the fluid is nitro-glycerin!

Because the players are now in control of the action, it becomes imperative that they understand their surroundings

John Dillon is an engineer for Rockwell International, designing automatic test equipment and writing control code for the instruments. He is also a songwriter and a student. His hobbies include reading and travelling by motorcycle.

and position amidst them. As in the days of yore, the best way to know where you are is to make and use a map. While there are a variety of techniques available, this article will focus on a method that has been personally successful. First, a couple of comments are in order. One: Let us define a “room” as any unique position in the game, whether it is an actual room, a pathway or corridor, or even a section of a single chamber. Two: *Use a pencil!* Though this is intuitively obvious, it is still frequently overlooked. Cartography is a detailed process that usually requires many changes before an acceptable final product is obtained.

Mapmaking Tools

It has been said that a sign of man’s intelligence is his ability to make and use tools. A useful tool for Adventurers is a mapsheet devised to ease the chore of Adventure mapping. [See Neil Haupt’s *Mapper* program (August ’87, Page 90), which prints a blank mapsheet on an 80-column printer.] While it is quite simple to use, it can contain a lot of information. Here is the procedure, using Figure 1 as an example.

First, arbitrarily select and label a box as the game’s starting point. Then indicate the obvious exits with short labeled stubs. In this example, the game starts with “You are in front of a castle. Obvious exits are North and East. You see nothing special.” Figure 1a shows this starting room (labeled “Front of Castle”) and the possible exits (‘N’ and

‘E’). Note that north doesn’t have to be up as on a regular map. Just be sure to label the map such that there is no confusion.

Next, try to discover where each of the exits go. In this game, going east would put you on a drawbridge, while north plants you firmly in the forest. When you enter a new room, repeat the process of Step 1, e.g., label the room and show possible exits as shown in Figure 1b.

Now that you have explored the obvious exits for the starting room, go back (if you can) and try unmarked directions, since sometimes you can travel in directions not explicitly described. For example, in trying “down” from the front of the castle, you discover that “You are now wading in the moat. Several crocodiles are eyeing you hungrily.” This means that you need to add a room, as shown in Figure 1c.

Sometimes a passage is unidirectional (Figure 1d). Indicate this with an arrowhead to show that you can’t get back. For example, after trying all other directions while in the moat, you discover that you can’t return to the front of the castle because “The banks are too steep and slippery; you keep falling back into the water.”

After exploring all possible exits (including Climb, Jump, Run, etc., if appropriate) for a particular room, it’s useful to mark the map so that you know that all exits have been exhausted. One way is to put an ‘X’ in the lower left corner, as shown in Figure 1e.

Figure 1f shows some other useful

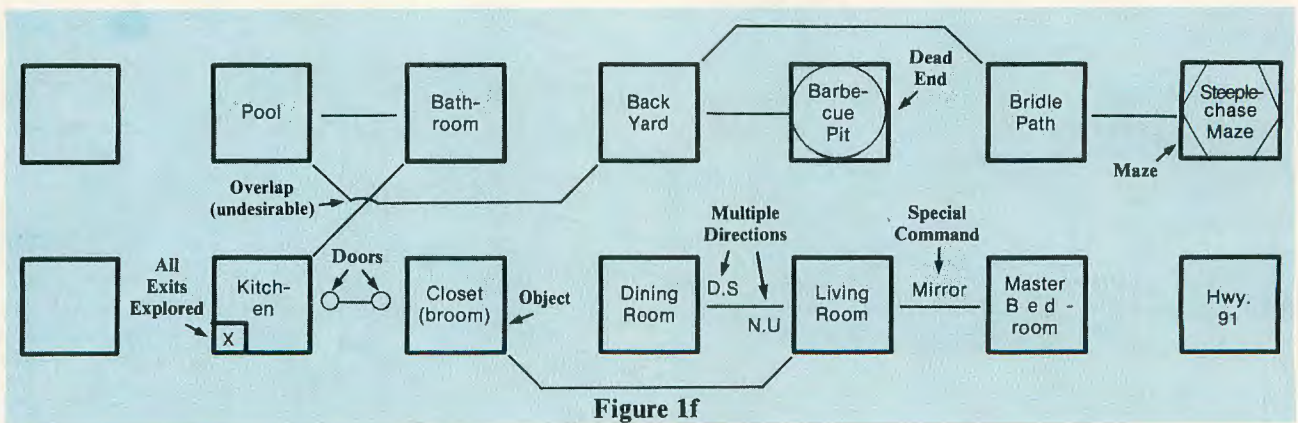
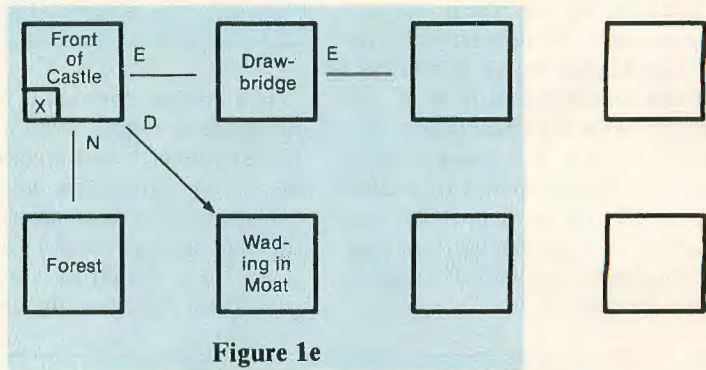
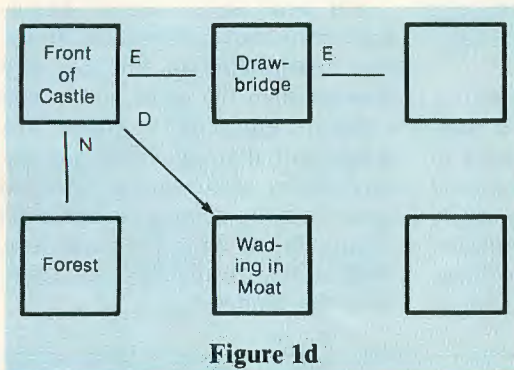
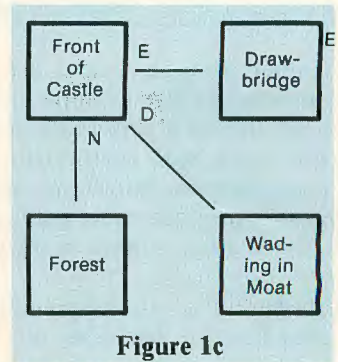
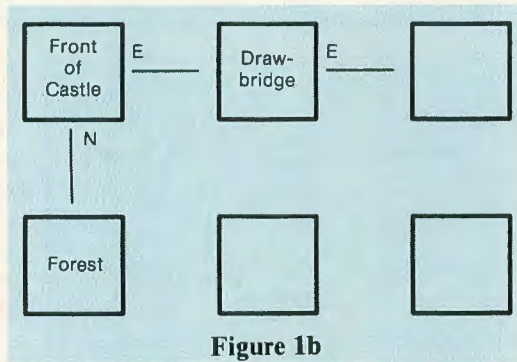
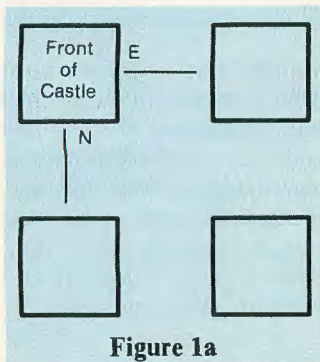

Figure 1

mapping notations. A small circle on a box indicates that a door has to be opened before you can exit in that direction. Parentheses can identify the objects found in a room, such as a

broom in the closet. If multiple directions take you to the same room, you can indicate both on a single line, such as in the living room.

After a while the map may get con-

volved, with one path crossing another a dozen times. When this happens, carefully redraw the map on a new mapsheet. Often, with judicious layout, you can eliminate crossovers.

As we wander around the maze, we continue to drop stuff behind us, marking the items we left on our map. (By the way, it is important to wander through the maze in a logical fashion, using the same techniques discussed earlier.) In our example, going south from "candelabra" (Figure 2b) put us in another maze-room, so we drop another item, this time the golden egg. Our inquisitive minds want to check the backward path, so we go north from "golden egg," and *voila!* we are indeed back in the "candelabra" room. Next we try east, ending up in "broom" (Figure 2c). West from "broom" puts us back at "golden egg," and we have already established some order to what once seemed to be a formidable labyrinth (Figure 2d).

As you get deeper into the maze, you must go back to the beginning portion to retrieve and reuse your landmark objects. If your game has a Save feature, using it can expedite this process.

After the maze has been solved, identify these rooms on your map as M1, M2, M3, etc., where 'M' stands for "maze." Figure 3 shows a portion of the

***"By using
mapmaking tools,
solving Adventures
becomes a simpler,
more organized task
— without depriving
you of any of the
fun and challenge."***

maze in one of Radio Shack's more popular Adventures.

Sometimes a game may have more than one maze. RAINBOW's *Rescue on Alpha II*, for example, has both the caverns and botanical gardens. As a result, my map shows rooms BG1, BG2,

etc., and C1, C2, C3, etc., thereby keeping them distinct.

For more information on mapping mazes (and on Adventure games in general) refer to *Compute!'s Guide to Adventure Gaming*. It is also an excellent reference source for people who want to write their own games. It was this book that first taught me the key to maze mapping.

Though Adventure games are exciting and challenging, they are also relaxing. Upon solving a good Adventure, you are left with a feeling of satisfaction knowing that you are clever enough to outwit a computer. By using mapmaking tools such as those described in this article, solving Adventures becomes a simpler, more organized task — without depriving you of any of the fun and challenge. Good luck, and may you always be smarter than the games you play!

(Questions or comments concerning this tutorial may be directed to the author at P.O. Box 6026, Fullerton, CA 92634. Please enclose an SASE when requesting a reply.)

One-Liner Contest Winner . . .

I read with interest Dennis Weide's article in the February '88 issue (Page 126) concerning reversing the PMODE screen in BASIC and Pascal. His BASIC program took one hour, and his Pascal program took one minute. My one-liner uses some of CoCo BASIC's built-in commands to perform the same task in 30 seconds! By using GET, PUT and PCOPY, CoCo can do the job quickly and efficiently — without peeks, pokes or Pascal!

The listing:

```
1 PCLEAR8:P MODE4,5:PCLS:SCREEN1,
1:DIMIN(256):Y=255:FORX=0TO255:P
MODE4,1:GET(Y,0)-(Y,191),IN,G:PM
ODE4,5:PUT(X,0)-(X,191),IN,PSET:
Y=Y-1:NEXTX:FORJ=1TO4:PCOPYJ+4TO
J:NEXTJ
```

*John Collicott
Inman, KS*

(For this winning one-liner contest entry, the author has been sent copies of both *The Third Rainbow Book of Adventures* and its companion *The Third Rainbow Adventures Tape*.)

Two-Liner Contest Winner . . .

Here is a CoCo 3 expression of a sentiment most undoubtedly felt by all CoCo owners!

The listing:

```
10 PMODE3,1:PCLS3:SCREEN1,0:CIRC
LE(128,99),90,4,.95:PAINT(128,99
),4,4:COLOR2:DRAW"BM128,40R9L18R
9D20R9L18":DRAW"BM60,70D20R18BM8
8,70D20R18U20L18BM117,70D20R18U2
0BM146,70D20R18L18U10R18L18U10R1
8BM146,100D20U20R9D10U10R9D20BM1
75,100D20R18U20D40"
20 POKE65495,0:DRAW"BM80,130D20R
18L18U20R18BM108,130D20R18U20L18
BM136,130D20R18L18U20R18BM164,13
0D20R18U20L18":PAINT(0,0),1,4:PA
INT(0,0),2,4:PAINT(0,0),3,4:PMOD
E3,1:SCREEN1,1:PAINT(0,0),2,4:PA
INT(0,0),1,4:PAINT(0,0),3,4:PMOD
E3,1:SCREEN1,0:RUN
```

*Doug Fingliss (Age 9)
Tiverton, RI*

(For this winning two-liner contest entry, the author has been sent copies of both *The Third Rainbow Book of Adventures* and its companion *The Third Rainbow Adventures Tape*.)



RAINBOW'S BROADENING ITS SPECTRUM

THE RAINBOW and the Delphi Information Utility have joined together to *allow CoCo owners* all over the world to connect with one another!

Delphi is a full-service information utility. It offers everything from up-to-the-minute news stories from The Associated Press to electronic mail services. But, *best of all*, it now has a **special forum for Color Computer owners, and it's operated by the people who bring you THE RAINBOW each month.**

The CoCo Special Interest Group (SIG) features a variety of services, including an open forum where you can send and receive messages from Color Computer owners all over the world. It also has several databases to which you can upload your favorite programs and from which you can download programs written by other CoCo enthusiasts. Some of these databases are BASIC programming, OS-9 and home applications.

When setting up your account with Delphi, if you do not have a credit card or prefer not to use it, Delphi requires that you send \$25 to give *your account* a positive balance. This will be refunded after your first free hour if you choose to no longer use the system or it will be applied to future connect charges. If you do not maintain a positive balance, you will be charged \$3.50 each month for direct billing.

PEEK INTO THE RAINBOW

The CoCo SIG's conference feature allows you to meet electronically with other members of the CoCo Community. You can join conferences with notables such as Dale Puckett, Cray Augsburg, Marty Goodman, Don Hutchison, Jim Reed, Lonnie Falk and others — on a regular basis. Conference schedules will appear in THE RAINBOW each month. Be sure to check online announcements for changes and additions.

THE OTHER SIDE OF THE RAINBOW

On Delphi, you also are able to buy RAINBOW ON TAPE — order a whole set, or download an individual program immediately. You can also renew your RAINBOW subscription, make a fast and easy order for software or hardware from a multitude of vendors, or inquire about products on the CoCo SIG.

We also have a number of **programs that you can download** and use, just for the cost of the time you spend transferring them. There'll also be **corrections for RAINBOW articles**, helpful hints and many other useful features.

FREE LIFETIME MEMBERSHIP

THE RAINBOW is offering subscribers a **free lifetime subscription to Delphi** — a \$24.95 value — and a free hour of connect time — a \$7.20 value at either 300, 1200 or 2400 Baud — so you can sample Delphi and the RAINBOW CoCo SIG. That's right. Your subscription to THE RAINBOW entitles you to this \$32.15 value as a **free bonus!**

If you're not a RAINBOW subscriber, just enter your order when you sign on with Delphi and you'll get the same great deal! For our \$31 subscription fee, you'll get the finest Color Computer magazine ever, a free lifetime subscription to Delphi and a free hour of connect time.

SAVE EVEN MORE

Want to save even more? While you're online you can order, for only \$29.95, a deluxe package which includes the Delphi membership, the *Delphi Handbook and Command Card* (\$21.95) and a total of three hours of connect time (\$21.60).

Delphi provides us all with **Immediate CoCo Community**. Check it out today. After all, you can sample it for free!

Problems? Call Delphi:
(800) 544-4005
(617) 491-3393

DELPHI

TYPE: GROUP COCO



COMMUNITY TOGETHER

How to reach RAINBOW's Color Computer SIG . . .

There are several ways to connect to Delphi and THE RAINBOW's CoCo SIG. In most cities you will not even have to pay long distance charges; you can use special data communications networks like Telenet, Tymnet and the Canadian Datapac network.

First, set your terminal program to operate at either 300 or 1200 Baud (depending on the modem you have), and also select either 7 bits with even parity or 8 bits with no parity, and one stop bit. (If one combination doesn't work, try another.)

Decide which network you should use. There is no surcharge for Telenet or Tymnet. Canadian residents using Datapac will be charged an additional \$10.80 (U.S.) per hour.

On Telenet: Uninet network has merged with Telenet. To get the Telenet number for your area, call (800) 336-0437. After you call the local access number and make connection, press ENTER twice. When the "TERMINAL=" prompt appears, press ENTER again. When the "@" prompt appears, type C DELPHI and press ENTER.

On Tymnet: Call (800) 336-0149 to get the Tymnet number for your area. After you dial your designated number and connect, you will see either "garbage" or a message saying "please type your terminal identifier." At this point, even if the screen is garbled, simply press 'A'. When "please log in;" appears, type DELPHI and press ENTER.

From Canada (on Datapac): Call Delphi Customer Service at (617) 491-3393 to get the Datapac number for your area. After you connect, press the period key (.) and ENTER (use two periods if you're using 1200 Baud). Type SET 2:1, 3:126 and press ENTER. Now type p 1 3106, DELPHI; and press ENTER. Delphi's new rates indicate an additional \$10.80 hourly surcharge for evening use of Datapac, which means a total of \$18 (U.S.) for connect time.

From other countries: Many countries have their own data networks that can connect to either Telenet or Tymnet. Check with the telephone authorities in your country for details on how to sign up for this service. When you have an account set up, you can reach Delphi with a "host code" of 3110 6170 3088 through Telenet, or 3106 90 6015 through Tymnet. (You'll have to pay the toll charges for this connection.)

Type in Your Username

If you're already a subscriber to THE RAINBOW, at the

"USERNAME:" prompt, type JOINDELPHI and press ENTER. At the "PASSWORD:" prompt, type RAINBOW. Then, at the "NUMBER:" prompt, type your individual subscription number from the mailing label of your latest issue of THE RAINBOW. (If there are one or more zeros at the beginning of this number, include them.)

If you don't already have a subscription, at the "USERNAME:" prompt, type JOINDELPHI and press ENTER. At the "PASSWORD:" prompt, type SENDRAINBOW and press ENTER. Have your MasterCard, VISA or American Express card ready, because you'll be led through a series of questions that will enable us to put your RAINBOW and Delphi subscriptions into effect. In an effort to hold down non-editorial costs, we do not bill for subscriptions.

If you make a typing error, just use Control-X and start over. Remember that at any point, when you're on Delphi, you can type HELP to get help on how to use the system. To get off the system just type BYE.

If you find that you're unable to log on to Delphi and enter the CoCo SIG after following these instructions, call us during afternoon business hours at (502) 228-4492. We'll be glad to offer assistance.

Come Visit Us! Type: GROUP COCO

After you sign in, you'll be prompted to set up your own, personal "user name" — Delphi is a friendly service, no numbers to remember — and you'll be asked a number of questions so Delphi can set up your account. You'll also be assigned a temporary password.

Delphi will tell you that your account will be ready after 6 p.m. the same day if you sign up before noon (Eastern time zone.) If not, your account will be ready at 6 p.m. the next day. Once an account is verified and opened, *each RAINBOW subscriber will be credited with an hour of free time!*

When you log back in, use your chosen username and your temporary password to access the system. At that point, you will meet Max, who will help you configure things and will change your temporary password into your own *personal* password. This is the password you will use for subsequent sessions — or until you change it.

After Max bids you goodbye, you'll wind up at the Delphi Main Menu; type in GROUP COCO and **join us on the CoCo SIG!**

A hardware project to handle the switching of the joystick and cassette ports.

The Old Switcheroo II

By Mark Haverstock

In the August '86 RAINBOW [Page 108], I presented a hardware project designed to switch among joysticks, trackballs, mice and other devices that use the joystick ports. It was designed to save CoCo owners the hassle of plugging and unplugging these items by allowing one joystick port to accommodate more than one device.

With the introduction of Tandy's Hi-Res Joystick Interface, another problem appears. Both the joystick port and cassette port must now be shared with the Hi-Res Interface. Enter the Old Switcheroo II. This switchbox will handle the switching of both the joystick and cassette ports. Armed with a few inexpensive parts and tools, you can build this convenient accessory for your CoCo 2 or 3.

The Joystick Switcher

Based on comments from several readers who wrote to me about the joystick switcher, I learned that most use the project to switch only two items, such as a mouse and a joystick. The new version is set up to switch two items. It also has a center OFF position to disable both devices. The OFF position is particularly important for programs that

Mark Haverstock teaches computer applications for the Boardman schools in Youngstown, OH. His hobbies include computing, photography and amateur radio.

are adversely affected by having joysticks plugged in during operation. A double-pole, double-throw switch has been substituted for the rotary switch that appeared in the original version because it is easier to wire. The switcher can be used with either joystick port, or with external devices such as the CoCo Max Hi-Res Pak.

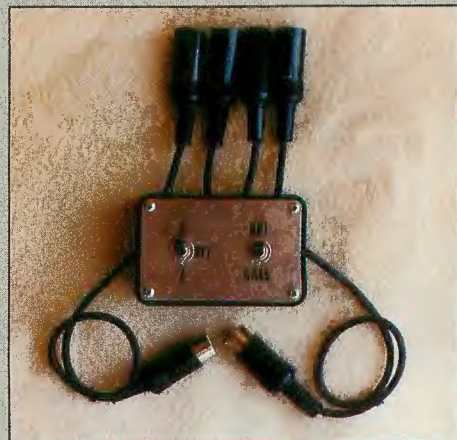

The Cassette Port Switcher

The Hi-Res Joystick Interface (Cat. No. 26-3028) uses both the joystick and cassette ports. This, of course, presents a problem for cassette recorder users who will need to plug and unplug the recorder. The Switcheroo II utilizes a double-pole, double-throw switch also to activate either the cassette recorder or the Hi-Res Interface.

You will need the following parts: One six-pin DIN plug (Cat. No. 274-

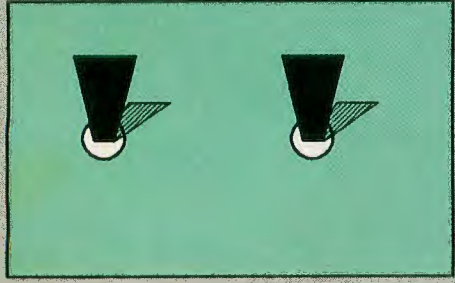
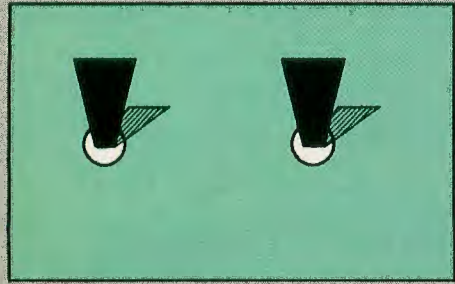
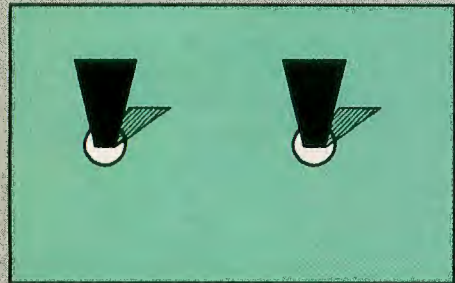
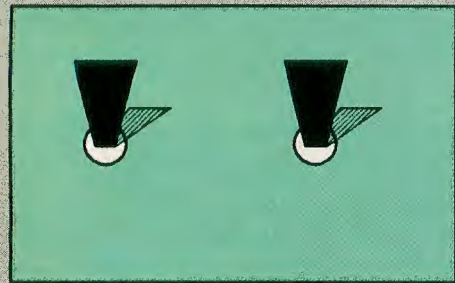
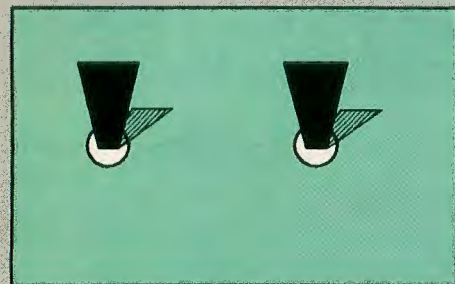
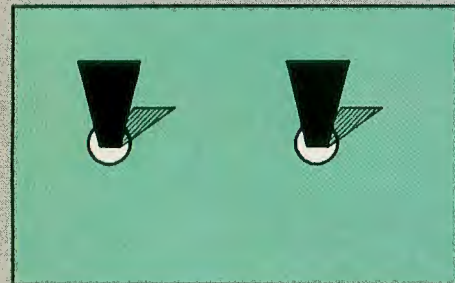

020); two six-pin inline DIN jacks (Cat. No. 274-021); a five-pin DIN plug (Cat. No. 274-003); two five-pin inline DIN jacks (Cat. No. 274-005); an experimenter box (Cat. No. 270-2301); a DPDT switch with a center OFF position (Cat. No. 275-664); a DPDT switch (Cat. No. 275-663); 4 feet of five-conductor wire; dry-transfer lettering; epoxy; and electrical tape or heat-shrink tubing.

The required tools include the following: a drill, 1/4-inch drill bit, flat metal file, small screwdriver, small Phillips screwdriver, wire strippers, pliers, soldering iron and solder.

Construction

Construction of the Switcheroo II will be described in three parts: the preparation of the project box, wiring the joystick port switch, and wiring the cassette port switch. Do each in order to avoid wiring errors.

First, take the metal cover off the project box, removing the four Phillips screws at each corner. Mark the positions of the holes to be drilled in the plastic portion of the box (see Figure 1). Then drill these holes using the 1/4-inch drill bit. Use the file to remove any burrs from the inside of the box.

Mark the positions of the switch mounting holes on the metal cover. Drill these holes with the 1/4-inch drill bit. Again, remove any burrs from the rear of the cover. Find the positions for SW1 and SW2 as shown in Figure 1, and apply dry transfer lettering at these positions.

Switch 1-Joystick Port

The next step is to wire SW1 for the joystick port. If you cannot obtain five-conductor cable, substitute five #22-gauge

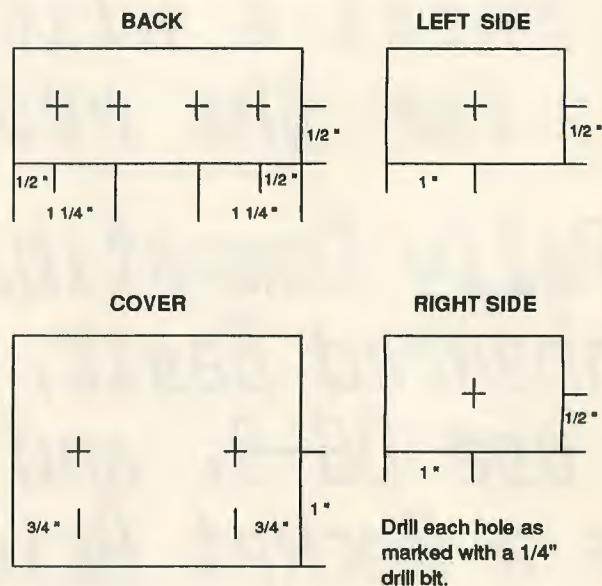
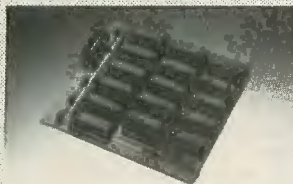

Figure 1: Preparation of The Switcheroo Enclosure.

TURBO RAM BOARD



\$39.95
ZERO K

\$119.95
512 K

- Fast 120 nsec RAM chips
- Easy-to-follow instructions
- No soldering
- Includes RAM Board Utilities

PYRAMIX Arcade Game \$19.95

BACKUP LIGHTNING (disk duplicator) \$14.95

RAM BOARD UTILITIES

- RAM Disk for RSDOS
- Print Spooler
- Sophisticated MEMORY TEST Program

\$19.95

PAL UPGRADE

\$7.95

for grey or white
MULTI-PACK (26-3024)

DUAL-MODE CONTROLLER



\$99.95*

*ROM not included (RS DOS
1.1 ROM—\$19.95) 32K
SRAM—\$16.95.

- 100% Compatible with existing H/W & S/W
- No MULTI-PACK required (low power draw)
- 8K Cache memory (expandable to 32K)
- Track Reads (programs load up to 2x faster)
- Two Switched Sockets (supports 8K ROM, 2764/27128/27256 EPROMs)
- Gold Contacts for reliability
- Easy Installation (no cutting, soldering, jumpers or external wires)
- Runs under OS-9 with:
 - no-halt read/write
 - interrupts and multi-tasking enabled
 - reliable clock and type-ahead

S&H: \$3.50 U.S. and Canada (\$15 foreign)
COD: \$2.25 U.S. only
2ND Day Air: \$1.50 (contiguous U.S. only)
Tax: inside California add 6%
VISA or MC accepted

**30 DAY MONEY-BACK
GUARANTEE PLUS FULL 1 YEAR
WARRANTY ON ALL PRODUCTS!**

Prices subject to change without notice

Send check or money-order to:

**Performance
Peripherals**
11432 Pena Way
Mira Loma, CA 91752
Or Call (714) 681-3007

"Window Master"

A Point & Click Window System
for the rest of us !!!

Fully Compatible with R.S. Dos
Enhanced Basic, it does not need
or use OS-9, and you don't have to
be a Rocket Scientist or a P.H.D.
to use Windows, Pull Down Menus,
Buttons, Icons, Edit fields or
Mouse Functions in your Programs!

Window Master Features

Multiple Windows

Window Master supports multiple window displays with up to a maximum of 31 windows on the screen. Overlapping windows are supported, and any window can be made active or brought to the top of the screen. Windows can be picked up and moved anywhere on the screen with the mouse. There are 6 different Window styles to choose from and the window text, border and background color is selectable.

Pull Down Menus

Menus are completely programmable with up to 16 menus available. They can be added or deleted at any time in a program. Menu items can be enabled, disabled, checked or cleared easily under program control. Menu selection is automatically handled by Window Master & all you have to do is read a function variable to find out which menu was selected.

Buttons, Icons & Edit Fields

Each Window can have up to 128 buttons, Icons or Edit fields active, if you can fit that many. Buttons, Icons and Edit field selection is handled automatically by Window Master when the mouse is clicked on one. All you have to do is read a Dialog function to find out which Button, Icon, or Edit field was selected, its very simple.

Mouse & Keyboard Functions

Window Master automatically handles the Mouse pointer movement, display and button clicks. It will tell you the current screen coordinate, the local window coordinate, window number the mouse is in, the number of times the button was pressed, which window number it was clicked in and more. The Keyboard is completely buffered, and supports up to 80 programmable Function keys that can contain any kind of information or command sequences you can imagine. You can load and save function key sets at any time. So, you can have special sets of function keys for different tasks. The "Ctrl" key is supported so that you have a full control code keyboard available.



Screen Display Fonts

Window Master supports up to 54 different character sizes on the screen with 5 different character styles. You can have Bold, Italic, Underlined, Super-Script, Sub-script or Plain character styles or any combination of them in any character size. You can also change the text color and background at any time to get really colorful displays.

Fully Basic Compatible

Window Master is fully compatible with Enhanced Color Disk basic with over 50 Commands & functions added to fully support the Point & Click Window System. Window Master does not take any memory away from Basic, so you still have all the Basic Program memory available.

Hi-Resolution Displays

Window Master uses the full potential of the Color Computer 3 display by using the 225 vertical resolution display modes instead of the 192 or 200 resolution modes like most other programs. It uses either the 320/16 color mode or the 640/4 color display to give you the best display resolution possible, and can be switched to either mode at any time.

OPTIONS

CLEAR SCREEN
DOTS
BOX
CIRCLE
LINE
QUIT

16,1,00,1,0,3,2,0

WINDOW GRAPHICS DEMO

↑ FOREGROUND COLOR ↓

LOAD
SAVE

PHICS DEMO
IONS", "CLEAR SCR
", "CIRCLE", "LINE
OAD", "SAVE"

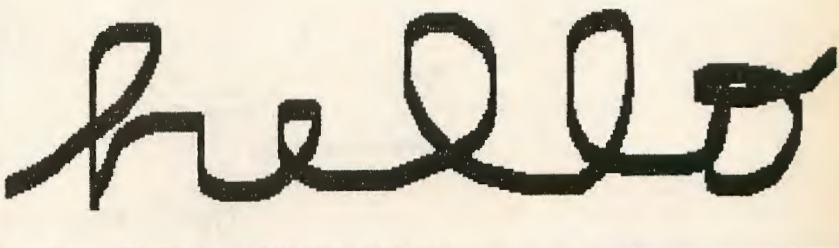

```
30 WINDOW OPEN 1,44,16,1,00,1,0,
3,2,0,"WINDOW GRAPHICS DEMO"
40 MW=1: MY WINDOW #=1
50 ON MENU GOSUB 540
70 MENU ON
80 PROTECT 3
90 ON DIALOG GOSUB 630: DIALOG 0
N
```

SAVE FILE
ENTER FILE TO SAVE

BREAK
OK
RUN

GFXTTEST.PIC:2

Mixed Text & Graphics

Window Master fully supports both Text & Graphics displays and even has a Graphics Pen that can be used with HLINE, HCIRCLE, HSET and more. You can change the Pen width & depth and turn it on or off with simple commands. We also added Enhanced Graphics Attributes that allow graphics statements to use And, Or, Xor and Copy modes to display graphic information. With the Graphics enhancements added by Window Master, you could write a "COCOMAX" type program in Basic! In fact we provide a small graphics demo program written in Basic.

Event Processing

Window Master adds a powerful new programming feature to Basic that enables you to do "Real Time" Programming in Basic. It's called Event Trapping, and it allows a program to detect and respond to certain "events" as they occur. You can trap Dialog activity, Time passage, Menu Selections, Keyboard activity and Mouse Activity with simple On Gosub statements, and when the specified event occurs, program control is automatically routed to the event handling routine, just like a Basic Gosub. After servicing the event, the sub-routine executes a Return statement and the program resumes execution at the statement where the event occurred.

Enhanced Editing Features

Window Master adds an enhanced editor to Basic that allows you to see what you edit. It allows you to insert & delete by character or word, move left or right a word or character at a time, move to begin or end of line, toggle automatic insert on/off or just type over to replace characters. The editor can also recall the last line entered or edited with a single key stroke. You can even change the line number in line to copy it to a new location in the program.

Window Master Applications

Window Master pushes the Color Computer 3 far beyond its normal capabilities, into the world of a "User Friendly" operating environment. We are already planning several new programs for use with Window Master. So you don't have to worry about having to write all your own programs. And don't forget that many existing Basic and M.L. programs will run under Window Master with little or no changes. The Possibilities for Application programs are endless: Spread Sheets, Word Processing, Communications, Education, Games, Graphic Design, Desk Top Publishing and on and on.

Hardware Requirements

Window Master requires 512K of memory, at least 1 Disk Drive, a Hi-Res Joystick Interface and a Mouse or Joystick.

Technical Assistance

If you run into difficulty trying to use some of Window Master's features, we will be happy to assist you in any way possible. You can write to us at the address below or call us between 10am and 2pm Pacific Standard Time for a more timely response. Sorry, no collect calls will be accepted.

Ordering Information

To order WINDOW MASTER by mail, send check or money order for \$69.95, plus \$3.00 for shipping & handling to the address below. To order by VISA, MASTERCARD or COD call us at (702)-452-0632 (Monday thru Saturday, 8am to 5pm PST)

CER-COMP Ltd.

5566 Ricochet Avenue
Las Vegas, Nevada 89110
(702)-452-0632

FILES DATE

New
Open
Save
Save As...
Init
Quit

CALENDER V 2.0
May 1988

	MON	TUE	WED	THU	FRI	SAT
	2	3	4	5	6	7
	8	9	10	11	12	13
15	16	17	18	19	20	21
22	23	24	25	26	27	28
29	30	31				

Call for availability of 128K version!

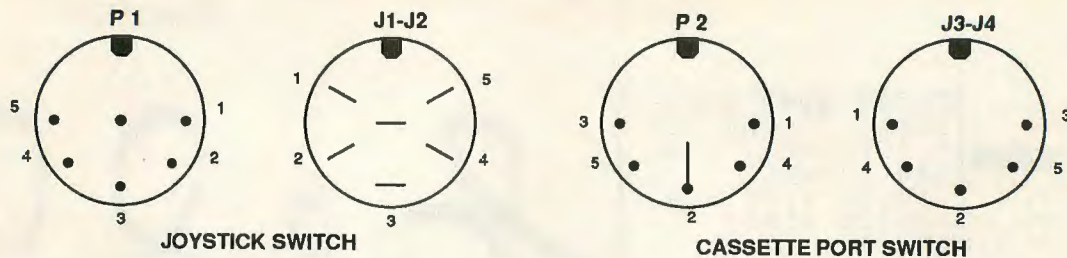

Figure 2: Plugs/Jacks Pinouts

stranded wires twisted together (preferably assorted colors), or use the wiring from an old, broken joystick. Prepare one 12-inch cable and two 6-inch cables by removing 1 inch of the outer jacket and stripping 1/4-inch of insulation from each individual wire at both ends. Remove the covers from the jacks (J1,J2) and plug (P1), then solder these wires, one to each pin, as shown in Figure 2. Before replacing the covers, be sure to inspect the solder connections for shorts.

Insert the remaining ends of the wires into the three holes located on the left portion of the project box. The wires from J1 and J2 use the two holes at the rear of the box; the hole on the left side is for P1. Wire the switch (SW1) according to the schematic in Figure 3. Note that only two of these lines are switched: the +5V and ground lines. The others will be matched, soldered together and covered with electrical tape or shrink tubing.

Switch 2-Cassette Port

Prepare three pieces of five-conductor cable: one 12 inches

long, the others 6 inches long, as described previously. Remove the covers from the jacks (J3,J4) and plug (P2). Next, solder these wires as shown in Figure 2, one wire to each pin. Inspect the wiring for possible shorts before replacing the covers.

Insert the remaining ends of the wires on the right side of the project box. The hole on the right side of the box is for P2, the remaining two in the rear are for J3 and J4. Wire the switch (SW2) according to Figure 4. Notice that as in the joystick switch, only two lines are switched. The others will be matched together, soldered and covered with electrical tape or shrink tubing. Mount both S1 and S2 on the metal cover, aligning the handle with the marked switch positions.

To secure the wires attached to the jacks and plugs, and to keep them from pulling out of the box, apply a small amount of epoxy to the point where these wires enter the inside of the box. Allow the epoxy to dry thoroughly before continuing.

Finally, reassemble the box, tucking the wires carefully

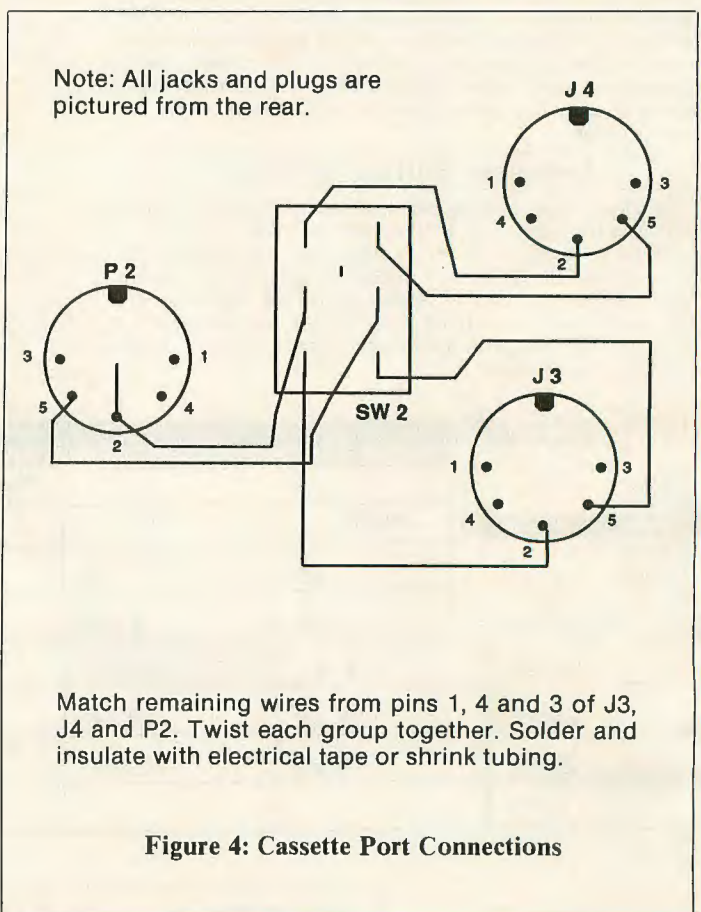
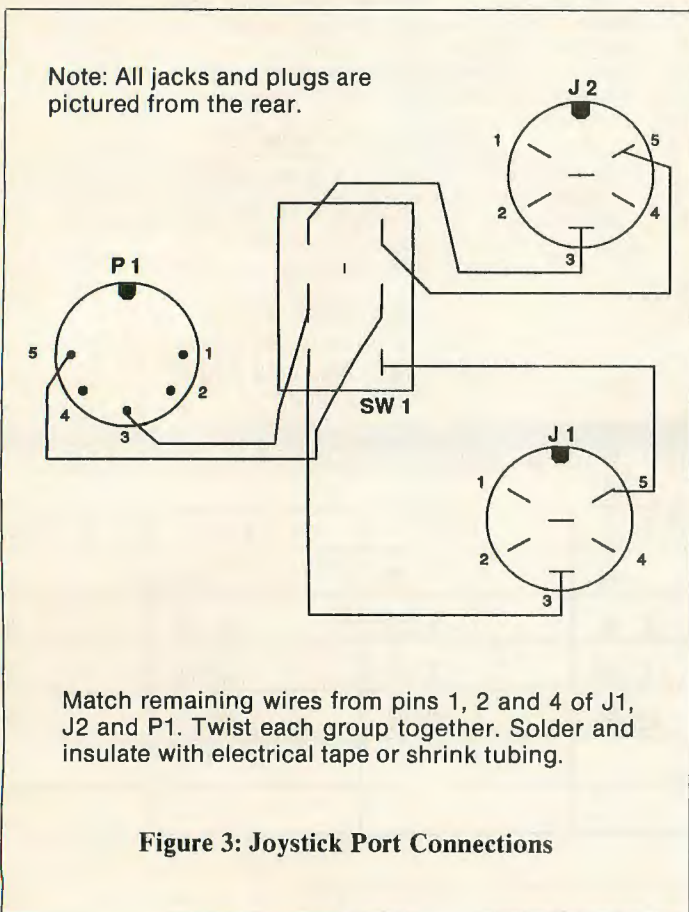

TO COMPUTER
JOYSTICK PORT

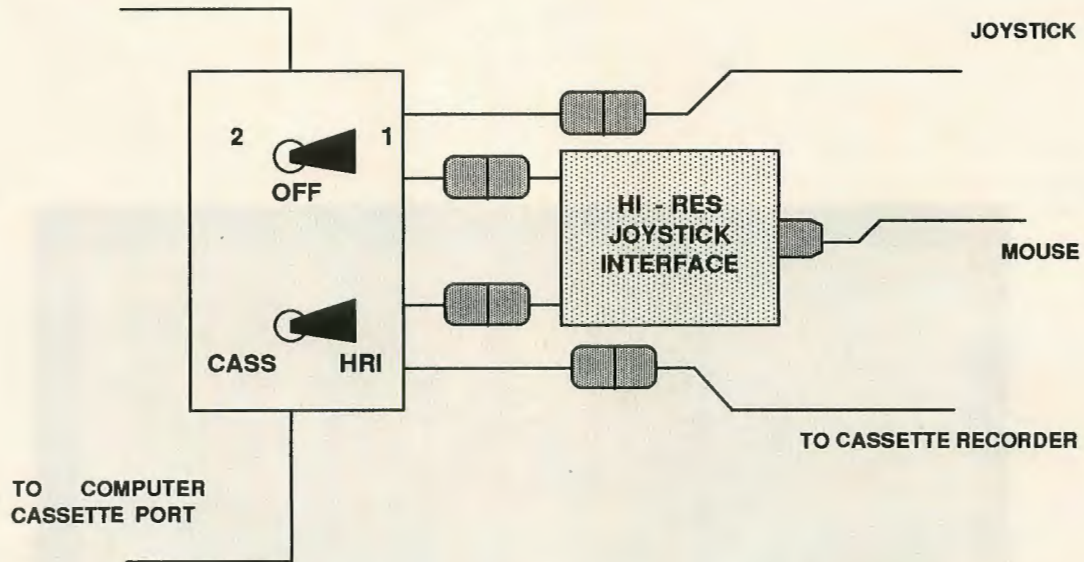

#1 - Switch between Hi-Res and regular positions for mouse and joystick. (Ex.: Use mouse for drawing tool, use joystick for games)

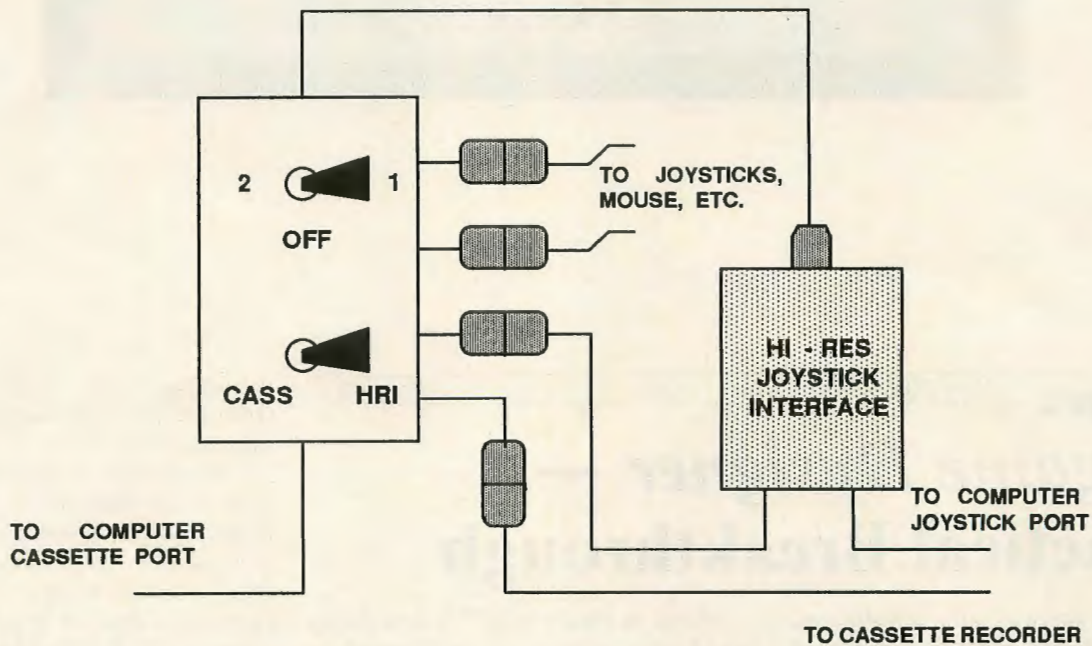

#2 - Use both devices for Hi-Res drawing. (Ex.: both mouse and joystick used for hi-res drawing tools)

Figure 5: Setup Diagrams

inside. As a finishing touch, cover the dry-transfer letters with clear nail polish to prevent them from rubbing off. To test it out, configure your Hi-Res Interface, cassette recorder and joysticks or other control devices as shown in Figure 5. Be sure to orient your accessories to match the marked switch positions. Now you can enjoy the convenience of switching

both cassette and joystick ports without unplugging.

(Questions or comments about this hardware project may be directed to the author at 6835 Colleen Drive, Youngstown, OH 44512. Please enclose an SASE when writing for a reply.)



Software

CoCo 3

Wargame Designer — A Tactical Breakthrough

The Texas sun was unmercifully hot, beating down like a physical presence on attacker and defender alike. Santa Anna's troops looked across the open area leading to the Alamo and swore; it looked so simple and yet the dusty ground was littered with their comrades' bodies.

The defenders peered wearily over the Alamo's walls, knowing they could not withstand another attack. Powder and shot were low, casualties were high. A collective sigh of resignation arose as they saw the Mexican troops begin to move forward one more time, most likely the last.

"What is that sound?" Santa Anna asked as an ominous whup-whup-whup filled the air, drowning out the thumping cannon and hissing rifle balls. His question was quickly answered as a troop of assault helicopters surged over the trees and began riddling his now-panicky troops with 2.75-inch rocket explosions and mini-gun bursts.

Science fiction? A movie with an exceptionally inept prop man? Every Texan's dream? Maybe. *Wargame Designer* from SPORTSware allows you to adjust the forces or terrain on the four provided scenarios, or design your own war game completely from scratch,

using either the troop and map icons from the program modules or tailored ones you devise.

"What if Napoleon had had more artillery at Waterloo?" Give him some more. "What if von Paulus had been able to link up with von Manstein's relief column?" Give him the troops and equipment and see if you can make it happen. If it doesn't happen, subtract a Soviet corps or two and try it again.

You virtually have a free hand to design the war game you desire, adjusting the forces by type and strength as you like and drawing the map to suit your own ideas. As the rule book cautions, though, you should make the opposing forces relatively equal unless history demands otherwise; designing a game to commit slaughter is hardly fair, no matter what mission you remember.

This double-sided, two-disk set is designed specifically and only for the CoCo 3, using its 128K and advanced

graphics capabilities to the fullest. The first question after loading is whether you have a composite or RGB monitor; the graphics look *ever* so much better on an RGB.

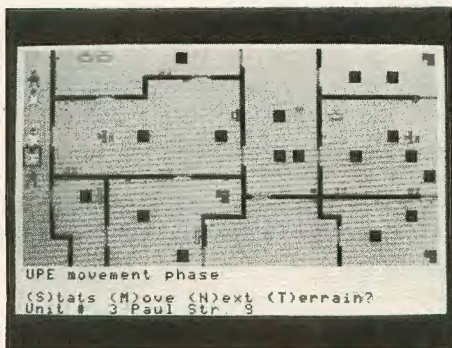

Since I have only a color TV, I wandered up to my local Radio Shack and asked to use one of their CoCo 3s hooked up to an RGB. Friendly and helpful people that they are, I was given free rein. Dave the salesman hung around to watch and was as impressed with the graphics as myself. While good enough on a TV set, they're truly spectacular on an RGB, and can be enhanced even further by the PALETTE command built into the system, allowing you to choose from among 64 colors.

The 23-page instruction/rule book comes in a folding plastic case along with two disks that are ready to be backed up. The instructions in fact suggest it. You'll have to do it anyway to design your own war games.

SPORTSware: Designer's Designers

SPORTSware, an 8-year-old, Toledo family-owned software company, stresses the word *strategy* in most of its products, being primarily interested in the strategic aspects of sports, science fiction, adventure and wars.

After designing a laserdisc football strategy game called *Live Action Football* (endorsed by the NFL) for arcades, they turned their talents to the CoCo. Their *Football Strategy* software was the arcade game without the laserdisc footage. Currently available software consists of *Gridiron Strategy* and *Weekly Winner* (for choosing lottery numbers), plus several separate war game scenarios not requiring *Wargame Designer (WGD)* to run.

Paul Olmstead programmed *WGD* specifically for the CoCo 3, inspired by its capabilities and some things he said he found unsatisfying about many current computerized war games: "Once you had played it through, there wasn't much else you could do with it; the graphics weren't appealing; many were for only one player and scenarios couldn't be changed." (He might also have added the lack of a game-saving option.) He stays with the CoCo 3 for the company's programs, feeling that every CoCo owner's secret desire is to own a CoCo 3.

A wargamer himself, Olmstead stated that he might have been one of the first people in the country to buy *Tactics* in 1964. Two years later, he was officially invited to participate in what has some-

times euphemistically been called the "Southeast Asia War Games." Instead, he enlisted, went to Officer Candidate School, served on the XVIII Airborne Corps' Commanding General's staff and found himself in Vietnam in 1968.

When asked about current projects, he obviously remembered his security clearance, responding, "We're not telling." Military and business experience taught him that you don't let the enemy or the competition know what you're doing until you've done it.

As a family businessman, Olmstead says that he relies a lot on his wife, Kathy, and daughter, Ashley, for support and understanding. The suspicion arises that the distaff side of the family may be the most severe and critical playtesters he has found. From my own experience, if I can get a new magic trick past my wife, it'll get by anybody.

SPORTSware encourages *WGD* owners to submit new scenarios for possible future use. Olmstead recently received a letter from a gentleman in Quebec who plans to create some additional *WGD* scenarios for his history classes and then share them with SPORTSware.

Considering the rampant imagination of CoCo owners, SPORTSware could become deluged with suggested battles, historical and speculative. Although nobody at the company has yet read *Red Storm Rising*, they might have to in order to understand some of the letters. □

War Games as History, or Vice Versa

Nobody knows for sure when commanders first began playing "What if?" games, trying to figure out what to do if their opponent did this or that. However, Wellington's remark "The Battle of Waterloo was won on the playing fields of Eton" could well have referred to a war game of some sort.

As weaponry becomes more precise and lethal, so must war games become more complex — which may explain why war games dealing with Napoleonic times may be the most popular: The weapons were sufficiently advanced to prevent all but the most inept commander from moving his forces in a single mass, yet uncomplicated enough to allow the rules to be relatively easy.

The first professional war game may have been *Kriegspiel*, developed by the Prussian general staff and perhaps partially responsible for their victory in the

Franco-Prussian War. H.G. Wells (yes, that one) is credited with inventing the first war game for amateurs — *Little Wars*, which used model soldiers.

We've come a long way since then: Modern military services use computers and other exotic devices to simulate the forces opposing each other. Artillery, air strikes and the like are still important but are complicated by acronyms such as EMP, EW, FLOT, ECM, ECCM, ASW and ALOC. All of these Simulations are designed to train the staff, test the current plans and inject just the right amount of confusion and lack of information to make it seem real.

Bookshelves and toy stores are filled with war games ranging from Greek Hoplites to 21st century space marines, all for us amateurs. Many of them become quite confusing in their complexity caused by the quest for realism. Comput-

erized games are much easier; the "commanders" make the decisions, the computer figures the results.

One vital point to remember, for both professional and amateur wargamers: Learn from the game and try not to repeat the dumb mistakes. A story has it that the Japanese naval staff war gamed an attack on Midway. The players portraying the Americans caught the other players while they were refueling and rearming their carrier planes, sinking two carriers. The chief umpire would have no part of that, since that might lead to an imperial defeat, and allowed only one carrier sunk.

A few years later, the same basic thing happened, this time for real. Many historians consider the Battle of Midway the turning point in the Pacific.

Did the U.S. Navy war game that one in advance? □

The system consists of five modules: unit icon design, map icon design, map design, unit attributes and the game module. The instructions walk you carefully through each of the first four modules, so it's almost impossible to mess it up if English is your primary language. However, when you design your own war game, make absolutely sure that you assign objectives for each army, man them and assign a Terrain Modifier of 8 to at least the Red army's town or fortress, even if you're re-enacting the Battle of Cannae as I was. Without objectives, the program checks to see if the Red forces occupy any objectives; finding none, it automatically declares the Blue forces the winner. This can be disconcerting when you've spent some time setting up the Order of Battle for each army and reviewed your notes on Hannibal. You can, by the way, design either one- or two-player war games; equally important is the capability to save a game in progress.

If you don't want to design your own from scratch, you can adjust various things on the four different games on the disks: Invasion North, Attack on Moscow, Robot Command and Dungeon Warrior. (These in themselves seem to be worth the price.) For example, you can change terrain features on the map, adjust movement points needed to cross terrain features, have reinforcements arrive earlier or later, and make a unit stronger or weaker. In addition, the entire thing is written in BASIC, so the hackers can play with that aspect also.

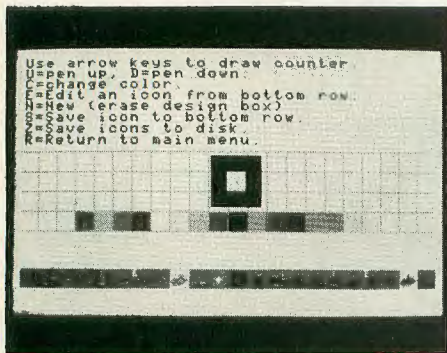

My only suggestion would be to install a default value when assigning movement costs and combat modifiers; you could then use the cursor to take care of the exceptions.

The scenarios provided aren't that easy, either. After slashing my way through the border defenses in Attack on Moscow (and feeling pretty smug about it, too), my troops started getting fire from the Soviet Katyusha rocket launchers. This continued all the way to

the Moscow suburbs, where my last bedraggled infantry unit perished under a rain of rockets.

The programs take up all but five granules on a disk, so you'll need to use a separate disk side for each game you design or modify. Difficult games can either be altered further or reformatted, backed up from the master copy and begun again. The only real limitation is your imagination.

In short, fanatical wargamers who have been waiting to fight some obscure battle from the War of the Roses don't have to wait any longer. Drag out the history books, lock and load a disk into your trusty CoCo 3 and have at it!

(SPORTSware, 1251 S. Reynolds Road, Suite 414, Toledo, OH 43615, 419-389-1515; \$29)

— John M. Hebert

Software

CoCo 1, 2 & 3

Fraze Craze — Wheel-Watching on the CoCo

Fraze Craze, a fun-to-play word game similar to the popular *Wheel Of Fortune* TV game show, was written for the 64K CoCo 1 or 2 but also works on the CoCo 3.

Fraze Craze is supplied on an unprotected disk, so a backup copy for your own protection is not a problem. The program is written in BASIC, and the instruction booklet contains directions on adding your own custom game data covering people, places, things and events.

The right joystick is used to move the onscreen cursor left or right to select the letter of your choice. When you press the firebutton, the "spinner" is activated; a highlighted cursor moves from left to right across the screen and stops on a number. This number represents the dollar amount to be played on a particular turn and will be multiplied by the number of correct letters that show up when you make your guess.

Just like on the TV show, you can also buy vowels; but because the game is written for one player, you compete with five "men." If you choose a letter that is not in the phrase, you lose one man — you will also lose one man if the built-in timer counts down to zero before you select a letter.

Letters are blocked out after each choice, so you can keep track of the ones already used. As soon as you think you know the answer to the puzzle, you can select the question mark and then type in the answer. If you are correct, you win the round and go on to a new puzzle; otherwise, you lose two men and continue the game.

I liked *Fraze Craze*. It's fun to play and educational, as well. Although the price is very reasonable, the program has one glaring flaw. Not once do you get a chance to see Vanna!

(RAM Electronics, 814 Josephine St., Monmouth, OR 97361, 503-838-4144; \$12.95)

— David Gerald

Software

CoCo 1, 2 & 3

Hardware

Syntrax 2.0 — CoCo MIDI Package

There you are, a record producer, sweating bullets, surrounded by millions of dollars of electronic recording gear at a major recording studio. The equipment and musicians are costing you hundreds of dollars per hour. Your master tape must be mixed and ready to go tomorrow and the client is there breathing down your back and even more nervous than you are. (No wonder. By the time it's all done, you may have spent over \$25,000 of the client's money recording the album!)

Suppose, in the middle of the session, I stopped you and said, "Hold on. Relax. I can get you the same quality product for the cost of a CoCo, a few synthesizers and *Syntrax 2.0* from Intercomp Sound. You'll save hours in costly studio time, and have more control at every step of the production."

You'd probably make an appointment with me first thing the next morning, wouldn't you?

I know just what I'm talking about, because I have had my own copy of *Syntrax* for a couple of years, and it has already saved me thousands of dollars in recording costs. (I am a pianist/synthesist/producer and have just finished producing one album in Nashville. I own five synthesizers, two MIDI-capable digital reverberation units, a drum machine and — of course — several CoCos.)

If you don't know what a MIDI synthesizer is, here is a brief explanation. (For more details, go to your local professional music store and ask for a demonstration of MIDI.)

MIDI is short for Musical Instrument Digital Interface and refers to a standard format for data transfer between electronic synthesizers. The data includes information such as how quickly a key on a synth was depressed, which note it was, how long it was held down, and so on.

MIDI's capability to quickly transmit the status of electronic devices (of which synths are only one example) is making it a de facto standard for the electronics-dependent recording industry. MIDI is such a developed protocol that it allows the musical imagination to go into territory unimagined just a few years ago.

Syntrax arrives with a thick manual and software. However, it requires the Color MIDI Connection, a hardware MIDI interface that connects between the computer and the disk controller. An extender ribbon connector is part of the interface, so I recommend a Multi-Pak to reduce those occasional I/O errors.

You install *Syntrax* by turning off your system and attaching the Color MIDI Connection. Then you attach your MIDI cables from the CMC to your synth, power up and type RUN "SYNTRAX".

The Channel mode prompt (CH>) flashes, waiting for commands; a sophisticated parsing routine interprets them. All available commands are presented onscreen.

Let's run through a sample session. Suppose we want to create a music file with the built-in editor. This uses the Insert mode, so we press I.

The screen clears, leaving us with the Channel mode prompt and a line number. At the cursor we type our musical data in letter form. Using the usual RS-DOS SHIFT-0 combination as necessary, we enter the following: CH> 1 c:d:e:f:g:a:b:C:D:E:F:G:A:B. This is two octaves of a C major scale.

Why do we mix uppercase and lowercase? *Syntrax* starts out with a default two-octave range, with the lower octave being represented by CoCo lowercase (reverse video) letters, and the upper octave with uppercase. Also, the default note duration is a quarter note. Notes are separated by a colon.

When you press ENTER, *Syntrax* compiles your text into MIDI data (compilation is incredibly fast), and you are brought automatically to the Play menu. Begin to play the line above by pressing B for Begin, and *voila!* Your MIDI keyboard plays what you typed! To continue with the rest of a composition, you simply add more text lines with the editor, compile them, and play them back to check them one at a time.

That was easy. What else is there? Flats and sharps are handled easily. Simply use the plus sign (+) for sharps and the minus sign or hyphen (-) for flats. One way to write an E-flat major scale would be CH> 1 e-:f:g:a-:b-:C:D:E-. The notation may seem hard to master, but it isn't — I got accustomed to the system in minutes.

Chords are easy, too. For a C major chord (which has the notes C, E and G), simply type CH> 1 cma.j. And for minor, type cmin. Diminished chords and chords with sevenths are implemented, too.

You can also specify each note in a chord, for that special voicing or for that "weird" sound not covered by usual chord notation. To make the notes sound simultaneously, don't separate

NEW FROM RTB SOFTWARE

Graphic Adventure Games
Adventure Trilogy But Each Is
A Stand Alone Game

LABYRINTH

Can you escape and save your kingdom?



QUEST FOR THE RING



Wander your vast kingdom in search of the Wizards Ring.
But beware!

ADVENTURE IN LUMERIA



After resting from the last 2 adventures you go on the last and final quest to save a beautiful princess from an evil count in the far off land of Lumeria.

All games may be backed up and use simple keystroke commands. All for 64K ECB Disk COCO 1 or 2.
LABYRINTH \$24.95 1 Disk
Quest for the Ring ~~\$46.95~~ Now \$34.95 2 Disk Set
Adventure in Lumeria ~~\$48.95~~ Now \$36.95 2 Disk Set
or get all 3 games for \$74.95 Add \$3.00 for S&H

Send check or Money Order to:
RTB Software
P.O. Box 777
W. Acton, MA 01720-0011

Phone # (508) 263-0563
All programs are guaranteed
to load and run

4-TECHS presents Arcade Feeling at Last

J.A.C. Joystick
Alternative
Controller
with Repeat Fire Control!

Use ATARI type joysticks with your CoCo. JAC comes with our unique rapid fire control switch, GREAT for Pegasus & Zaxxon. Works with majority of joystick controlled games.
New from 4-TECHS
Introductory Price **\$22.50**
4-TECHS 4-TECHS 4-TECHS 4-TECHS 4-TECHS

S.T.O.P. Save Time
On Pause.

CoCo users, now Pause any program at the touch of a button, then resume when you're ready. NOW **\$14.95**
ONLY!

4-TECHS

P.O. BOX 2575
Merrifield, VA 22116

PLEASE
ALLOW
4-6 WKS
DELIVERY

them with colons: CH> 1 d e g b F.

Duration of the notes can be manipulated, too. Here is a funk bass line in *Syntrax* notation:

```
CH> 1 ? r/16:d--e:r/B:d-
/16:r:e-r:d--e-/B:c--
```

Rests are denoted by *r* and the duration of a note is specified by a slash followed by the duration required. In the example above, *r/16* means a 16th-note rest, *e-/B* means an E-flat in the bass clef for an eighth note duration. If no duration is specified, the previous duration is implied.

Several lines of this kind of text, when listed to the screen or printer, can be difficult to interpret months (even hours) later. Luckily, *Syntrax* allows you to fully comment your data. Simply

type in a line of music, type a semicolon to signal that what follows is a comment, and then enter your comment. For example:

```
CH> 1 & D-maj E-/1:E-maj
F/1; Rhodes chords, measures 1
and two
```

The compiling step, initiated with ENTER, will ignore all text followed by the semicolon. Note that the question mark (?) and the ampersand (&) denote bass and treble clef, respectively.

Other features of *Syntrax* Channel mode include transposing by any number of half-steps; sending out specific MIDI bytes such as program change, attack velocity, pitch-bend, and MIDI channel data; easy implementation of repeats, even with nested re-

peats; memory conservation by chaining to other files.

After you have entered a file, you will want to hear it. Go to the Play menu (from the main menu), where you can choose to begin playing (B), to stop play in the middle (S) or to continue playing (C). You can fast forward with the clever view feature (V) and you can interactively change the tempo during playback with the tempo option (T).

Is that all for the Play menu? Hardly.

Play's "More" option (M) brings up a whole new screen, which allows you to do the following: choose your synchronization source, either the computer itself or an external sync device, such as another sequencer or a drum machine; send out a MIDI "tune" command to all your synths to make sure they all tune their internal oscillators, a great feature for initializing an extensive MIDI setup "at the gig"; select your clock resolution (24, 48 or 96 pulses per quarter note); choose to display note names as the sequence is playing; "mute" (de-select) any of the Channel files you have created (essential for recording studio applications).

The Channel files you create are combined to play simultaneously. But when I go into the studio, I don't want all the files to play at once. I typically record my music one track at a time with only one synth, so I need to mute all parts but the one I am currently recording.

Are you starting to get the feeling that *Syntrax* 2.0 is feature-packed? Believe me, it is.

In addition to the Channel mode, *Syntrax* offers System mode. You change to System mode after saving your Channel mode files to disk (which *Syntrax* reminds you to do with an "Are You Sure?" message).

In System mode, you assemble individual Channel mode files into a System mode file. This System mode file specifies the Channel mode files you want to include, determines the tempo and any tempo changes within the song if necessary (called "Global Track"), and provides access to a Play menu similar to that available in Channel mode.

In addition to using the Channel mode editor to input notes, *Syntrax* offers two more input methods, Step-Time Recording and Real-Time Recording.

Step-Time Recording allows the user to hook up his or her MIDI-equipped synth to the MIDI-In port of the Color MIDI Connection and insert (I) notes from the synth keyboard instead of



star
micronics

MULTI-FONT PRINTER
NX-1000
NEW



7 Color Printer
NX-1000 RAINBOW

The NX-1000 gives you plenty of print options for attractive printing. Four typesets. Four pitch sizes, in standard and italics for a total of 32 NLQ modes. The NX-1000 Rainbow gives you all these features plus online access to 7 color printing and graphics. Black, blue, red, yellow, green, violet, and orange. Both models have a 1 year warranty, nationwide service and a 30 day online trial.

NX-1000 SPECS: 144 cps Draft, 36 cps NLQ (18 x 23 dot matrix), 4 NLQ Fonts, Italics, Sub & Superscripts, Emphasized, Doublestrike, Proportional, Condensed, International, Downloadable, Quad Tall, Double Tall, Underline, 9+ Pitches, Forward and Reverse n/216 Line Feeds, Absolute or Relative Vert. & Horz. Tabs, Left, Center or Right Justification, 8 Graphics Modes to 1920 dpi, Macro Instruction, Bidirection, Adjustable Tractor Feed, 200+ Printable Characters, Semi Auto Sheet Feed, Front Panel Soft Touch Control, Epson and IBM Emulate, 4k Data Buffer, Hex Dump.
Rainbow: Same plus color.

NX-1000 SYSTEM INCLUDES:

- Star NX-1000 Printer
- Blue Streak Ultima
- Software Support Trio

\$199⁹⁵
+\$10 Shipping and Insurance
COMPLETE

NX-1000 RAINBOW SYSTEM INCLUDES:

- Star NX-1000 Colour Printer
- Blue Streak Ultima
- Software Trio
- Color Super Gemprint

\$288⁹⁵
+\$10 Shipping and Insurance
COMPLETE

Software Support Trio

TYPE SELECTION/TUTORIAL	SUPER GEMPRINT	HI-RES SUPER GEMPRINT	Software Trio \$19⁹⁵
Online instructional program that will select 24 special features of your printer or display methods to incorporate them into your programs.	Will transfer a Pmode 0, 1, 2, 3, or 4 picture screen to printer 8"x11" hardcopy. Black/white, white/black or grey level shading for color.	Disk software that will transfer a Hscreen 1,2,3 or 4 picture screen to printer. Grey level shading for color.	<p>FREE with purchase of any NX-1000 Printer</p>
Price, availability and specifications subject to change without notice.			

DAYTON ASSOCIATES of W.R. HALL, INC.
7201 CLAIRCREST, BLDG. D
DAYTON, OHIO 45424
OHIO RESIDENTS ADD 6% SALES TAX • C.O.D. ADD \$2.00

PERSONAL SERVICE
(513) 236-1454
Visa & MasterCard
within the continental U.S.

from the CoCo keyboard. First, tell *Syntrax* that your synth is on from the main menu. Next, choose Insert. Instead of being brought to the Channel mode editor, you are now in a new screen full of a host of new options. Just start playing, and your notes will go into the buffer. Durations are not recorded, but are easily added by tapping the space bar.

Step-Time Recording mode offers several crucial editing functions, which may either be activated by the CoCo or assigned to several "spare" notes of your synth keyboard. Activating editing from your synth allows you to spend less time going back and forth between synth and CoCo.

Step-Time Recording provides the ability to do the following:

- alter note durations
- loop playback so you can hear your sequence over and over
- enable and disable triplet note duration
- interactively change playback tempo
- fast-forward and rewind through your sequence
- switch over to Real-Time Recording.

Real-Time Recording is the final input mode offered by *Syntrax* and is particularly useful for more capable keyboard players. Real-Time Recording records notes *and* their durations.

Let's take a quick look. Real-Time Recording provides a great built-in metronome and quantization. Quantization is like the grade-school process of rounding off fractions to whole numbers, except you are rounding off your sloppy playing to the nearest 16th note or eighth note, or whatever unit you need to clean up the slop.

A song-position pointer is also implemented. MIDI pros will be glad for this, as SPP allows the CoCo and a drum machine to keep tabs on each other's place in a composition.

This is only an overview of the structure and sense of operation of *Syntrax*. There are dozens more features, including some not documented (like MIDI delay and track-shifting for that really relaxed drum feel) and some rather esoteric (like telecommunicating sequences and controlling light rigs with MIDI signals).

It might be best to conclude with my overall impression of the product from the professional point of view.

Syntrax provides an easy way to get at the "byte level" of MIDI data. It is so memory-efficient that I will eat my

hat if you can compose a piece with it and use up the memory. The drum machine interface is the most reliable of any MIDI program for the CoCo. The manual is complete. *Syntrax* is fairly easy to learn; the more you know about music, the better. It has never failed me in the studio.

Syntrax, for now, is my MIDI sequencer of choice for the Color Computer. However, it lacks chiefly in two areas.

One, the user interface, while well-designed, has problems. Channel mode is somewhat like programming in BASIC at times. Input from the Real-Time mode needs the ability to record polyphonically. And the program *never* shows a musical staff. This is enough to make educators balk at using this otherwise powerful tool. Many musicians,

too, would rather see a staff than be caught dead learning "programming."

Two, the manual — which comes well-bound and professional-looking — does not read as professionally as the program operates. It is largely complete, but not entirely clear and contains a few grammatical errors.

But these are small criticisms. The manual is improving with each revision, and there are other enhancements, too, including changes to the Color MIDI Connection that make it safer to add and remove MIDI cables while powered up.

Syntrax 2.0 provides features not found in many — if not most — other MIDI software packages. (In fact, I know no other RS-DOS program of *any* kind that offers more features.) And I hear the folks at Intercomp Sound are

The Ultimate Serial to Parallel Converter!

7 Switchable Baud Rates
300 • 600 • 1200 • 2400 • 4800 • 9600 • 19200

Use this "smart" cable to connect a Centronics parallel printer to any version CoCo or use it to improve performance of your current printer.

Try it on your system for 30 days RISK FREE. One year warranty. Dealer inquiries on quantity 3+.



Color Super Gemprint

Print your Graphics Screens in Color on your NX-1000 Rainbow

Color Screen Dump Software

Use your favorite program to create a pmode or hi-res graphic image, but don't stop there! Run our color graphics software and print a color image using a palette of 81+ colors on your NX-1000 Rainbow from a CoCo 1, 2, or 3. This system superimposes 4 graphic screen dumps (black, blue, yellow & red). The colors mix and add to give you your own color masterpiece.

System Requirements: 32k ECB Disk, Blue Streak 1, 2, 3 or Ultima

\$19.95

FREE with purchase of NX-1000 Rainbow Printer

Price, specifications subject to change without notice.

DAYTON ASSOCIATES of W.R. HALL, INC.
7201 CLAIRCREST, BLDG. D
DAYTON, OHIO 45424
OHIO RESIDENTS ADD 6% SALES TAX • C.O.D. ADD \$2.00

PERSONAL SERVICE
(513) 236-1454
Visa & MasterCard
within the continental U.S.

working on a CoCo 3 version that will knock our socks off.

All in all, I would say that *Syntrax 2.0* is the one to buy if you plan on getting into professional performance and recording. If you have a CoCo 3, however, I suggest you wait until the guys at Intercomp get the new *Syntrax* out.

(Intercomp Sound, 129 Loyalist Ave., Rochester, NY 14624, 716-247-8056; *Syntrax*, \$95; Color MIDI Connection, \$98: First product review for this company appearing in THE RAINBOW.)

— Paul Ward

Software

Flight Simulator II — Realistic Flight Simulator for the CoCo 3

If you enjoy flying, either as pilot or passenger, you will like this entry into the CoCo 3 market from SubLOGIC Corporation — *Flight Simulator II*, or *CC-FS2*, which simulates the instruments and flight characteristics of a Piper P-28-181 Archer II.

The program, written in OS-9 Level II, boots using the familiar DOS command with RS-DOS 2.1 or later. If you have an earlier version of RS-DOS, a short program is provided in the documentation to allow you to boot the program from BASIC.

The Piper Archer II is a single-engine, 148 mph, non-retractable gear aircraft equipped with a good set of avionics. The author chose to simulate the Archer II because of its overall good performance, simplicity and ease of flying.

This simulator is well-packaged and is sure to catch your eye on your dealer's shelf. The package consists of a single non-protected disk and flight maps of the Los Angeles, Chicago, New York, Boston and Seattle areas. Also included are two soft-cover books: *Pilot's Operating Handbook and Airplane Flight Manual*, which will help you figure out how to fly the simulator; and *Flight Physics & Aircraft Control*, a 92-page, informative mini-manual that explains the dynamics of flight and aircraft control. Inside *Pilot's Operating Hand-*

book is a handy "Flight Reference Card" that shows at a glance the keys that control the aircraft's elevators, throttle, trim, rudder and brakes. It also provides information on selecting views out of the cabin window. You will find yourself using this card frequently.

Although the graphics look best on an RGB monitor, provisions are made to run the program on both composite monitors and TV sets. I used the keyboard to control the program, although joysticks can be used. The *CC-FS2* disk contains a war game and several scenery files for the Chicago, Los Angeles, New York and Seattle areas.

A "Quick Test-Flight" mode is available and will allow you to start flying as soon as you boot the program. I preferred to watch the demo mode for a while to get a feel for what was out there and to see the controls operating. The screen is split horizontally. The top part of the screen displays what you, the pilot, see when you look out the window. This view is adjustable for side, back and forward views.

The bottom part of the screen displays the instrument panel, which is really "loaded." Space does not allow me to detail each and every control, knob, indicator, etc. But suffice it to say that the panel is jam-packed with such items as an airspeed indicator, altitude indicator (horizon), altimeter, heading, trim, stall warning, elevator, rudder and flap position. Also monitored is oil pressure, fuel, the magneto, COM and NAV radios, tachometer, carb heat, omni bearing, course deviation and glide slope.

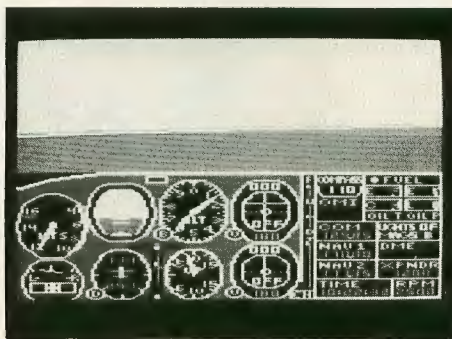

One or two joysticks can be used to control flight. The left joystick controls the aileron in the left-right direction and the elevator in the forward-back direction. The button is used to select the cabin view. The right joystick, if used, controls the flaps in the left-right direction and the throttle in the forward-back direction. The right joystick button controls the brakes while on the

ground and guns while in the War Game mode. If you don't have joysticks or don't want to use them, you can still fly with *CC-FS2*.

Clusters of keys on the CoCo's keyboard are used for the various phases of flight control. For example, the ailerons are controlled with the F, G and H keys, representing the left, center and right ailerons. The elevators are controlled with the T key (down) and the B key (up). Elevator trim and flaps are similarly controlled. The rudder moves from left to right using the C and M keys, and your brakes are activated by the space bar.

Although *CC-FS2* is easy to fly, I found the hard part to be in the landing. In fact, flying was all I accomplished during this review. After several crashes, I concluded that I wasn't cut out to be a pilot anyway. I was able to "buzz" the Sears Tower in Chicago a couple of times. The realism is really apparent to you when you fly low and change the view out the window as you pass buildings, mountains, etc. The colors are great, but the motion, while a little jerky, is no worse than that found on the IBM version of *Flight Simulator*. In fact, the program looks a whole lot like the IBM product to me.

The author of the program, Bruce Artwick, has done an excellent job in adding realism to *CC-FS2*. Everything from cloud formations, night flying (dark outside with instrument lights only) and wind are user-controlled from a setup screen activated by the F1 key. You can even fly on instruments if you are so inclined.

The War Game option is a lot of fun, too. You will see the gun site in front of you as you take off and declare war on the enemy. Be prepared for some dog-fighting fun as you shoot your dual machine guns and drop bombs on enemy territory.

Flight Simulator II is a fine program for the CoCo 3. Not only does it provide some serious diversion from the usual game fare, but it challenges and educates, as well. I recommend *CC-FS2* for your CoCo 3. Whether you are a pilot or just interested in flying, *CC-FS2* will give you the chance to fly without suffering some serious consequences.

(SubLOGIC Corporation, 713 Edgebrook Drive, Champaign, IL 61820, 217-359-8482; \$24.95: Available in Radio Shack stores nationwide.)

— Jerry Semones

Mini Database — A 32K Database for Little Lists

While more and more of what I consider "serious software" is becoming available for our powerful Color Computer, I am glad to see companies bringing out good productive software for those people and purposes that do not require complicated and expensive software. *Mini Database* by Tothian Software is such a program. It is not a large and full-featured database program, yet that is not what it is supposed to be. It is what its name implies — a 32K mini database. It will handle a lot of the jobs most people use an expensive database for, and it does it very well.

If you have jobs that honestly do not require the special abilities of an expensive database program, but do require some data manipulation, you may be looking for a program just like *Mini Database*. It allows you to create files for friends or club members, addresses, phone numbers, home inventory, maintenance schedules, collections, etc.

Mini Database is available on both disk and cassette. If you purchase the tape version, you'll still be able to use the program when you upgrade to disk. The program is written in BASIC, which gives it some distinct advantages.

Once the program is loaded and run you are guided by very simple menus. The program is very user-friendly, but it is not "idiot proof." Being written in BASIC helps, though. For example, you can accidentally exit the program without saving your data (there is no "Are you sure?" feature), but this is no problem in BASIC — all of your data is still in memory; just typing GOTO 7000 gets you back to the main menu with all your data intact. If you accidentally press the BREAK key, typing CONT or the GOTO statement will get you to the main menu.

The program does not check for memory area. If you try to create a database too large, you will get an OM Error. This just means you will have to create a number of smaller databases or revise the original. I am not pointing these things out because I think they are problems, I am pointing them out because they are easy to get around with a little thinking. Being written in BASIC

makes the program easy to recover from mistakes.

BASIC also makes *Mini Database* compatible with all three CoCos. I am very impressed with a company that keeps coming out with inexpensive, easily expandable software the average CoCo owner can buy for small jobs. Do people really need a database program that is going to run anywhere from \$80 to \$250 just to keep track of club mailing lists? I believe there is a lot of work out there that can be done very well with smaller, less complicated programs. You may even find *Mini Database* a whole lot easier to use than the expensive database programs that do all those things you don't really care about, anyway.

(Tothian Software Inc., Box 663 Rimersburg, PA 16248; \$14.95)

— Dale Shell

Software

CoCo 3

In Quest of the Star Lord — Seeking the Phoenix Crossbow

As the son of an internationally famous scientist, you have been imprisoned in a research work camp following a 12-year interworld war. Your father, who was killed during the war, had provided you with a scientific education and a bright future. In your research you come across passages referring to the prewar empire of the Star Lord and his ultimate weapon — the Phoenix Crossbow. You decide to escape from your prison and search for the Phoenix Crossbow. You know that if you find it, your freedom will be ensured forever.

In Quest of the Star Lord is an animated action Adventure written for the CoCo 3 and one disk drive. The package includes two floppy disks so that the Adventure will fit on two disks rather than four. The graphics are superior and without a doubt the best I've seen to date on the CoCo 3; the 320-by-200 resolution is razor-sharp on my Tandy CM-8 RGB monitor. The program works on composite color monitors and TV sets, as well.

The program is copy-protected and warranted for one year, and will be replaced during that period free of charge if needed.

Starting the Adventure is as simple as typing LOADM "BOOT" and pressing ENTER. After selecting monitor type, a colorful and rather dramatic title screen appears, complete with flashing lighting and a musical interlude.

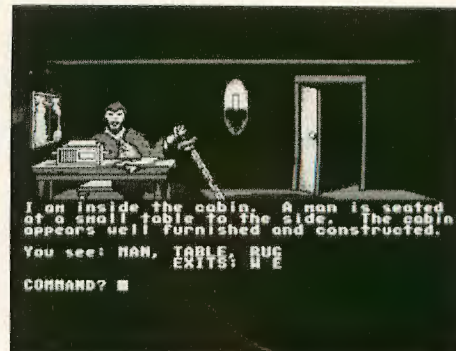

The program responds to standard two-word commands at the prompt. These commands must consist of a verb followed by a noun — GET ROCK, for example. Abbreviations are also accepted, such as I instead of INVENTORY. Also, as is customary, direction is controlled by commands such as GO NORTH, or simply N. If you are serious about solving this Adventure, it's wise to make a map of your travels.

The ability to save your progress is provided so that you don't have to keep repeating each command as you move on to different locations and screens. Simply typing SAVE and pressing ENTER provides a prompt that allows you to save your last six attempts.

I found *In Quest of the Star Lord* extremely challenging and fun to play. Whenever I get a chance to review graphics Adventure games, my 11-year-old daughter sits for hours fascinated with the endless possibilities and often surprising results. The two of us working together have made a lot of progress in this Adventure, but at the time of this writing have not even come close to the solution. As with most Adventures, part of the fun is trying to figure out the right commands. We found that while seemingly simple commands are often appropriate, it sometimes takes a while to come up with them.

The animation often manifests itself in the form of moving cloud formations, lightning and flashing lights. The use of shadows provides a realistic and often striking effect — you have to see it to believe it is being generated on your little old CoCo 3.

In my opinion, *In Quest of the Star Lord* is quite simply a dynamite program. It's not a fast-paced game by any stretch of the imagination, but rather a

strategy-filled exercise sure to provide hours of excitement and enjoyment.

(Sundog Systems, 21 Edinburg Drive, Pittsburgh, PA 15235, 412-372-5674; \$34.95 plus \$2.50 S/H)

— Robert Gray

Software

CoCo 3

Power Stones of Ard — The Quest for the Spirit Stone

The popular “dungeons and dragons” type games lend themselves particularly well to the computer. And since the first home computers began to gain in popularity, this type of game has amassed a large and loyal following. Three C's *Power Stones of Ard* now brings the challenge of swords and sorcery to CoCo 3 users.

Millenia ago, when the forces of Good and Evil battled each other for control of the world, three magical stones were created. Among them, they contained all the magic and power of the forces of Good. Alas, they were stolen by the Evil Ones, and now each is protected in a separate fortified stronghold — tempting treasure for a resourceful Adventurer. This is where you come in! You must try to find that particular stone called the “Spirit Stone” and take it away from the Evil Ones. . . .



Bill Cleveland, the program's author, has created an attractive screen to display all the necessary status reports (wealth, character information, etc.) for game play. The lower-right section of the screen is used for scrolling graphics scenes, featuring overhead views of the

traveler's locale; these are attractively done and well-executed.

At start-up, the user can elect to create a character, load a previously created one or opt to use the default character. The traits of strength, intellect, dexterity and constitution are user-definable. Based on the character selected, the computer then generates starting amounts of gold and health points (necessary for success).

Most commands are performed by a single key press. Movement about the world is accomplished by use of the arrow keys. Other examples are <A>t-tack, uy, <G>et, etc. Use of the CTRL key and function keys is supported.

I found the game both fun and challenging enough to provide hours of entertainment. The program comes on a single unprotected disk for user convenience. A booklet contains loading instructions, documentation for all commands and a handy quick-reference guide. Another plus for the program is price. *Power Stones of Ard* should find its way into many CoCo 3 software collections.

(Three C's Projects, P.O. Box 1323, Hamlet, NC 28345, 919-582-5121; \$18)

— Leonard Hyre

Software

CoCo 3

Thexder — From the Folks Who Brought You GoBots

Americans seem to have a love affair with things “Made in Japan.” Toyota cars arrive by the boatload; Noritake dinnerware graces the table of many a U.S. household; Panasonic consumer electronics of all kinds are sold in ever-increasing numbers. Americans are even developing a taste for thinly sliced raw fish served on rice.

With the exception of the *sashimi*, these products have earned their niche in the marketplace due to their high quality and reasonable prices.

Now another Japanese import is claiming our attention — *Thexder* has arrived. What is *Thexder*? Well, it's a “robot” that comes to you via the very American computer company in

Coarsegold, California — Sierra On-Line.

The *Thexder* “Super Assault Vehicle” is supplied on a ROM pack and comes alive with a little help from your CoCo 3. In the game, you are the pilot of the *Thexder* Super Assault Vehicle. Your mission is to destroy the central computer, which creates evil creatures and turns them loose on the world.

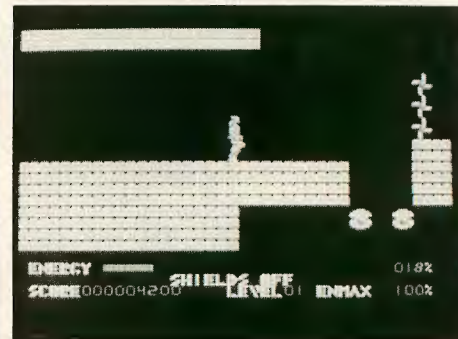

As you proceed, you are faced with various challenges. There are more than 20 types of aliens to do battle with, and the game gets more difficult the further you advance. Caves, vast cargo holds and spaceship interiors are all turned into battlefields.

A variety of armament and shields are available to assist *Thexder*, including a very unique ability — *Thexder* can change from a robot to a jet fighter. Yes, just like on the *GoBot* TV show, you can “transform” back and forth at the touch of a button.

Unlike simpler arcade games, *Thexder* uses multiple screens, music and excellent animation. Shields, differing energy levels, hidden traps and a seemingly endless variety of scenarios all combine to make this a game you will be drawn to. Like the more familiar Sierra Adventure-type games, *Thexder* gives you a lot of play time for your money.

How good is *Thexder*? Well, it's the best-selling arcade game in Japan. Over 500,000 units have been sold there. While arcade games are passé here, the fury continues in Japan. To be the best in Japan, an arcade game has to be very good. And *Thexder* is!

Thexder sends you on a perilous journey. But if you have a CoCo 3, it's quite a trip.

(Sierra On-Line, Inc., Coarsegold, CA 93614; \$24.95; Available in Radio Shack stores nationwide.)

— Bruce Rothermel

RS-232 Switcher — Making the Connections

A new vendor in the CoCo market, Radcomp is making its presence known by offering quality construction at a very reasonable price.

The product in question is an RS-232 switch. While the unit I received was of the two-position variety, a more useful three-position switch is also available. Both switches are offered for retail sale at approximately one-third the usual cost for such devices.

A top-mounted two- or three-position rotary switch indicates which port is currently active. Input is via a standard male CoCo four-pin serial connector attached to a 2-foot length of cable. Two (or three) female serial outputs, which are mounted along the 4-inch length of the case, complete the

assembly. Overall finish and construction are excellent, and the unit should provide reliable, trouble-free service.

If you are an old hand at plumbing countless devices into your CoCo, no doubt you already own one, if not several, RS-232 switching devices. On the other hand, if you are new to the world of CoCo computing, you will very soon encounter the need for multiple RS-232 connections. While a switching device can't provide you with multiple active inputs, it does away with the never-ending cable swapping that accompanies the single-port, multiple accessory setup that most of us eventually construct.

Incredibly, this simple product is accompanied by four pages of installation instruction, and includes several paragraphs on hints and operation — all this for a simple switch. While I feel that documentation is absolutely essential, this effort probably constitutes a bit of overkill.

Radcomp obviously has our best interests at heart, as evidenced by a 30-day, money-back guarantee and the inclusion of a lifetime warranty on their

products, and that commitment is acknowledged. But I would suggest the people at Radcomp retain a bit more profit from their enterprise by curtailing (excessive) printing expenses and devote the difference to additional product offerings. The CoCo Community always welcomes quality. Welcome aboard, Radcomp!

(Radcomp Computers, 1865 E. Broadway #420, Tempe, AZ 85282, 602-894-6489; two-way Switcher, \$10; three-way Switcher, \$11.50: First product review for this company appearing in THE RAINBOW.)

— Henry Holzgrefe

SPECIAL DEAL ON 500 PROGRAMS IS BACK!

BACK BY POPULAR DEMAND! GET OUR LATEST 50 DISKS OR TAPES FULL OF OVER 500 PROGRAMS. HERE IS WHAT YOU'LL RECEIVE:

- ★ Over 250 Utility/Home Application Programs including a Word Processor, Database, Spreadsheet, Disk Utilities, Business Software, Electronics Series, Educational Programs for Kids, plus much more!
- ★ Over 200 exciting games including King Pede, Kron, Star Trek, Flight Simulator, Wizard, Horse Races, Football, plus much more.
- ★ Over 30 adventures including Rambo, Haunted House, Power Sword, Skid Row, plus 32k graphic adventures.

Individual issues sell for \$9⁰⁰ each or \$450⁰⁰ for all 50. We slashed the price to only \$150⁰⁰!

REG. \$450 **NOW** \$150⁰⁰

★★THIS MONTH ONLY★★

Buy this package of 500 programs and receive a free 6 month subscription.



COOL DOWN TO OUR SUMMER PRICES ON SUBSCRIPTION SOFTWARE

THERE IS NO BETTER WAY TO ENJOY THE SUMMER THAN TREATING YOUR COLOR COMPUTER TO 10 READY-TO-RUN PROGRAMS EACH MONTH. GET 12 DISKS OR TAPES A YEAR CONTAINING OVER 120 QUALITY PROGRAMS. A SUBSCRIPTION TO T & D SOFTWARE CONSISTS OF 10 READY-TO-LOAD PROGRAMS DELIVERED BY FIRST CLASS MAIL EVERY MONTH.

NO, WE ARE NOT THE SAME AS THE RAINBOW ON TAPE. IN FACT, MANY SUBSCRIBERS HAVE WRITTEN IN AND SAID THAT WE ARE MUCH BETTER THAN RAINBOW ON TAPE!

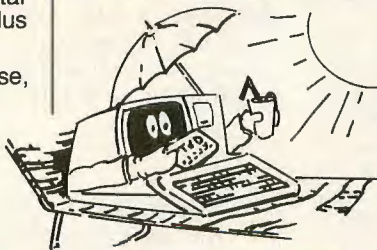

PRICES

	TAPE	THIS OR DISK MONTH ONLY
1 YEAR (12 issues)	78.00	60.00
6 MO. (6 issues)	48.00	35.00
1 ISSUE	9.00	8.00

Michigan Residents Add 4%
Overseas Add \$10 to Subscription Price
Personal Checks Welcome!

- ★ Available on COCO 1, 2, and 3
- ★ Includes Documentation
- ★ Over 4,500 Satisfied Customers
- ★ Back Issues Available From July '82 (Over 720 Programs)

TURN TO PAGE 30 & 31
FOR A COMPLETE LISTING



PLEASE SPECIFY TAPE OR DISK

T & D SUBSCRIPTION SOFTWARE, 2490 MILES STANDISH DR., HOLLAND, MI 49424 (616) 399-9648



The following products have recently been received by THE RAINBOW, examined by our magazine staff and issued the Rainbow Seal of Certification, your assurance that we have seen the product and have ascertained that it is what it purports to be.

EZGen, a disk-based boot editor for OS-9 that allows OS-9 programmers to edit OS-9 modules or data blocks contained in a specified file. For all CoCos and OS-9 Level I or II; 512K required on the CoCo 3 for OS-9 Level II. *Burke & Burke, P.O. Box 1283, Palatine, IL 60078, 312-397-2898; \$19.95.*

Home Bingo, a program that lets you play bingo at home. The numbers are as large as your monitor display, and randomly selected numbers are never repeated during any game. Requires 32K; for the CoCo 1, 2 and 3. *Williams Enterprises, 53 Old Derry Road, Box 7, Hudson, NH 03051, 603-883-2859; tape, \$9.95; disk, \$11.95. Plus \$2 S/H.*

Math Games, a children's educational math package that consists of four BASIC programs: *Raceway*, *Pyramid*, *Go to the Top* and *Math Word Problems*. *Raceway* pits the player against the computer in a race of mathematical problem solving. *Pyramid* is a three-level speed drill. *Go to the Top* helps students with multiplication. *Math Word Problems* presents problems that require addition, subtraction, multiplication and division. For the CoCo 1, 2 and 3. Uses the high-speed poke. *E.Z. Friendly, Hutton & Orchard Streets, Rhinecliff, NY 12574, 914-876-3935; \$19.95 plus \$1.50 S/H.*

A Mazing World of Malcolm Mortar, a bricklayer's nightmare as you, an apprentice bricklayer, become lost in the mazes of a mansion gone mad. Your foreman has been transformed into the evil Malcolm Mortar, Master of the Mansion Maze and all its creepy creatures. Can you brick up the monsters and find your way through? For the CoCo 3. *Tandy Corporation, 1700 One Tandy Center, Fort Worth, TX 76102; \$29.95: Available in Radio Shack stores nationwide.*

Moon Runner, an arcade game in which the Trigan forces have overtaken the moon system surrounding your planet. Assigned to the Moon Runner, an amphibian surface patroller armed with lasers and missiles, you attempt to destroy the Trigan base. Requires a joystick, 32K and one disk

drive. For the CoCo 1, 2 and 3. *Nick Bradbury, 10500 Sandpiper Lane, Knoxville, TN 37922, 615-966-0172; \$15.*

Multi-Menu, a *Multi-View* compatible menu utility that allows you to define your own menus for use in the *Multi-View* environment, designed so that anyone can use it, not just programmers. For the 512K CoCo 3, OS-9 Level II, at least one disk drive and *Multi-View*. *Alpha Software Technologies, 2810 Buffon St., Chalmette, LA 70043, 504-279-1653; \$19.95.*

Quest for the Ring, a sequel to *Labyrinth* in which your character, even though he has destroyed the evil wizard Zarth, must suffer the consequences of spells Zarth cast before he died. To undo the effects of the spells, you must find the ring he used to make them. Requires 64K Disk ECB; for the CoCo 1 or 2. *RTB Software, P.O. Box 777, W. Acton, MA 01720, 508-263-0563; \$34.95 plus \$3 S/H.*

TX Mail, a mailing list program that allows entry and editing of addresses. All entries are automatically in edit mode; the cursor is always nondestructive. For the CoCo 1, 2 and 3. *Kolesar B/S, 7 Ladd Ave., Westfield, PA 16950, 814-367-5384; \$26.95 plus \$2 S/H.*

Teddy Bears, an educational quiz program that employs teddy bears in the learning process. If a child gives a correct response, the bears dance. Teachers or parents can use the program to create various types of

quizzes: short answer, fill-in-the-blank, true/false, etc. Joystick and mice supported. Requires 64K ECB and uses the high-speed poke. *E.Z. Friendly, Hutton & Orchard Streets, Rhinecliff, NY 12574, 914-876-3935; \$19.95 plus \$1.50 S/H.*

Vocal Freedom, a program that turns your CoCo into a digital voice recorder, letting you record your voice or any other sound directly into the computer's memory. Features include sound-activated playback, disk save and load and voice-activated recording. Requires 64K CoCo, Radio Shack Audio Amplifier with built-in speaker (Cat. No. 277-1008), and a microphone. *Dr. Preble's Programs, 6450 Outer Loop, Louisville, KY 40228, 502-969-1818; \$34.95.*

The Zapper, a utility that allows you to patch files, as well as entire disks, directly. It displays your file or disk in a format similar to the dump command that comes with OS-9. Requires a 64K CoCo, one disk drive and OS-9 Level I or II. *Alpha Software Technologies, 2810 Buffon St., Chalmette, LA 70043, 504-279-1653; \$19.95.*

Zoomdump, a PMODE 4 and PMODE 3 graphics screen dump that allows custom printout sizing to within a fraction of an inch. It works with Extended BASIC and a DMP-105 or compatible printer. *Codis Enterprises, 2301-C Central Drive, Suite 684, Bedford, TX 76021, 817-283-8571; \$14.*

F First product received from this company

The Seal of Certification program is open to all manufacturers of products for the Tandy Color Computer, regardless of whether they advertise in THE RAINBOW.

By awarding a Seal, the magazine certifies the product does exist — that we have examined it and have a sample copy — but this does not constitute any guarantee of satisfaction. As soon as possible, these hardware or software items will be forwarded to THE RAINBOW reviewers for evaluation.

— Lauren Willoughby



*The second in a series of tutorials for the beginner
to intermediate machine language programmer*

Machine Language Made BASIC

Part II: High Finances

By William P. Nee

First, let's review the SORT program from last month's article. (See Listing 1.) In the random number portion, we used LDY #5400 to indicate the upper left corner, but in the sort portion we used LDX #5400 for the same location. This was necessary because the random routine at \$BF1F uses Register X for its own computations. We could have used Register X if we had saved it prior to executing \$BF1F and recalled it afterwards; it was easier to use Register Y instead, since it was unchanged. It is a good idea to check any ROM routines for the registers they use prior to putting them in your program. If you have a choice between using Register X or Register Y, use Register X as it takes less memory and executes faster.

In the random portion of our program we checked to see if we had reached the end of the text screen, but in the sort portion we had to check to see if we were one space before the end. This was necessary because loading Register D with the contents of X actually loads Register A with the contents of X and loads Register B with the contents of X+1. If we allowed X to go to the end of the text screen, X+1

Bill Nee bucked the "snowbird" trend by retiring to Wisconsin from a banking career in Florida. He spends the long, cold winters writing programs for his CoCo.

would move into the beginnings of graphics — and really start to make a mess!

Line 260 uses a branch (BLS) to see if one number is less than or the same as another number. Some branches compare signed numbers and some compare unsigned numbers. Figure 1 shows a comparison of branches for signed and unsigned numbers and what these branches check for.

So far, we've been using whole numbers generally between -32,000 and +32,000, but what about larger numbers or decimals? There is a way to input and save any number within the computer's range; however, it is only accurate to nine digits.

The routine at \$A390 is the equivalent of LINE INPUT in BASIC. Whatever you input is stored in memory at \$2DD in ASCII format. After executing \$A390, \$2DC will contain a zero, \$2DD+ will be the ASCII numbers, and the end will be a zero. Register B will be the length of the input plus one, and Register X will be #52DC. Any number you input can be preceded by +, -, &H (Hex), or O (Base 8).

The routine at \$9F reads whatever is in a buffer whose location is stored in \$A6/A7 and continues to read the buffer one byte at a time into Register A until a zero is reached.

Finally, the routine at \$BD12 will change the ASCII numbers in Register A to floating point format in FP1.

Putting all of these routines together gives us a SAVE subroutine. (See Listing 2.) Check your result by using the print subroutine from last month's article, Example 13A. (See Listing 3.)

Once a number is in FP1, it usually then has to be stored in some location. The easiest way to do this is to use the routine at \$BC35 to transfer a number in FP1 to the location in Register X using either its name or location. It will take five bytes to completely store the number in floating point format, so reserve five bytes for each number you will be saving in your program.

Let's try the simple program shown in Listing 4 that will take any number, store it and then print it. Our print routine is good only for printing numbers, but BASIC has a PRINT USING command that gives you much more flexibility and lets you use the \$, commas, +, -, etc. The routine at \$BFA1 is the PRINT USING command for machine language; however, some setup is required.

First, determine the number of characters that will be to the right of the decimal, add one, and load this into Register A. Then determine the number of characters you will need to the left of the decimal (including the \$ sign, commas, number signs, etc.) and load this into Register B. Register D is then stored in Location \$D8/D9. The two numbers in \$D8/D9 cannot total more than 17. If they do, you will get either

a wrong answer or a Function Call error message.

Location \$DA must contain a number indicating which format to use. The more common numbers are:

```
$DA    FORMAT
#$2    (-)number
#$4    number(-)
#$8    (+/-)number
#$C    number(+/-)
#$10   floating $
#$40   floating ,
#$50   floating $/,
```

Adding the numbers together will combine the results. Adding one to the number will print the result in exponential format.

If you need a PRINT @, load Register D with the @ location (+#\$400) and store it in Location \$88 (cursor location). Then you can load Register X with a message location minus one, and JSR \$B99C will print the message. Try the program shown in Listing 5.

Note that there is a space before the actual message. This space does not appear when the message is printed at Location \$420. Without the space we would have had to change the message location line to LDX #MSG-1. The message must end with a zero (FCB 0) to indicate the end of the message. Instead of FCB 0 we could have used FDB \$0D00 and eliminated the JSR \$B958, since either will print the carriage return (#\$0D).

The comparison programs (listings 6 and 7) for this article are simple financial calculators. Each program asks for the annual interest rate, the number of months of the loan (term) and the amount borrowed (financed). The pro-

Shifts

BCC Branch if carry clear (=0)
BCS Branch if carry set (=1)

Unsigned Numbers

BHI Branch if higher
BHS Branch if higher or same
BLO Branch if lower
BLS Branch if lower or same
BEQ Branch if equal (is 0)
BNE Branch if not equal (is not 0)

Signed Numbers

BGE Branch if greater than or equal (to 0)
BGT Branch if greater (than 0)
BLE Branch if less than or equal (to 0)
BLT Branch if less (than 0)
BMI Branch if minus
BPL Branch if plus
BEQ Branch if equal (is 0)
BNE Branch if not equal (is not 0)

Figure 1: Assembly Language Branches

grams compute the monthly payment and print the answer in the PRINT USING "\$#,###.##" format. You then have the option of inputting any new amount, term, or interest rate. If you run the machine language program from BASIC clear sufficient memory first (CLEAR 200, &H3000-1).

As a project, try to modify the program so it will compute the amount, term or monthly payments depending on what you input. Don't try to compute the rate — there is no exact for-

mula for doing so. The basic formulas used in this program are:

$$\text{rate} = \text{annual rate}/1200$$

$$\text{pv} = ((1+r)**\text{term})-1/r((1+r)**\text{term})$$

$$\text{monthly payment} = \text{amount}/\text{pv}$$

(** is used as a symbol for exponential)

(Questions or comments concerning this tutorial may be directed to the author at Route 2, Box 216 C, Mason, WI 54846-9302. Please enclose an SASE when requesting a reply.) □

Listing 1:

```
ORG $3000
START JSR $A928 clear the text screen
LDY #$400 top left of text screen
LOOP1 LDD #255 load register D with 255
JSR $B4F4 convert to a FPl number
JSR $BF1F get RND(255)
JSR $B3ED put it in register D
STB ,Y+ put the CHR$ in register Y, move to next space
CMPY #$5FF check to see if at bottom right of text screen
BLS LOOP1 if not, branch back to LOOP1
SORT LDA #1 create a
STA FLAG test "flag"
LDX #$400 top left of text screen
LOOP2 LDD ,X+ load register D with $400/401, move to $401
PSHS B save the contents of $401
```

	CMPA	,S+	compare what's in \$400 to what's in \$401
	BLS	CONT	branch if it's less or equal to what's in \$400
	EXG	A,B	if not, exchange the contents of \$400 and \$401
	STD	-1,X	put them back in \$400 and \$401
	CLR	FLAG	set the "flag" to zero
CONT	CMPX	#\$5FE	one away from bottom right of text screen?
	BLS	LOOP2	if not, branch back to LOOP2
	TST	FLAG	check the "flag"
	BEQ	SORT	if it's zero, sort again
	JSR	\$ADFB	if not, wait for any input
	SWI		end the program (use RTS if in Basic)
FLAG	RMB	1	reserve one byte and call it "flag"
	END	START	

Listing 2:

SAVE	JSR	\$A390	input any number
	STX	\$A6	put #\$2DC in \$A6/A7 (buffer location)
	JSR	\$9F	increase the buffer location, store ASCII in "A"
	JSR	\$BD12	make it a floating point number until reaches 0
	RTS		end the subroutine

Listing 3:

PRINT	JSR	\$BDD9	transfer FPl to buffer at \$3DA
	LEAX	-1,X	decrease location for sign
	JSR	\$B99C	print buffer contents
	JSR	\$B958	print a carriage return

Listing 4:

	ORG	\$3000	
SAVE	JSR	\$A390	what's the number?
	STX	\$A6	buffer starts at \$2DC
	JSR	\$9F	increase buffer, load "A" with first number
	JSR	\$BD12	convert to floating point in FPl
	LDX	#NUMBER	where to store it
	JSR	\$BC35	move the number in FPl to (X)
PRINT	LDX	#NUMBER	where it is
	JSR	\$BC14	move the number in (X) to FPl
	JSR	\$BDD9	FPl to ASCII format at \$3DA
	LEAX	-1,X	decrease buffer location
	JSR	\$B99C	print buffer contents
	JSR	\$B958	print a carriage return
	SWI		end of program
NUMBER	RMB	5	
	END	SAVE	

Listing 5:

	ORG	\$3000	
PRINT	LDD	#\$420	print @ location \$420 (second line down)
	STD	\$88	store in cursor location
	LDX	#MSG	message location
	JSR	\$B99C	print message
	JSR	\$B958	print carriage return
	SWI		
MSG	FCC	* THIS IS A SAMPLE MESSAGE*	
	FCB	0	
	END	PRINT	

Listing 6: FINANBAS

```

10 CLS
20 INPUT"ANNUAL RATE";R:GOSUB 18
0
30 INPUT"MONTHLY TERM";T:GOSUB 2
00
40 INPUT"AMOUNT FINANCED";AMOUNT
50 PMT=AMOUNT/PV
60 PRINT"MONTHLY PAYMENT IS - ";
70 PRINT USING"$#,###.##";PMT
80 PRINT"ANY NEW AMOUNT (Y/N)"
90 A$=INKEY$:IF A$="" THEN 90
100 IF A$="Y" THEN 40
110 PRINT"ANY NEW TERM (Y/N)"
120 A$=INKEY$:IF A$="" THEN 120
130 IF A$="Y" THEN 30
140 PRINT"ANY NEW RATE (Y/N)"
150 A$=INKEY$:IF A$="" THEN 150
160 IF A$="Y" THEN 20
170 END
180 R=R/1200
190 RETURN
200 PV=((1+R)^T-1)/(R*(1+R)^T)
210 RETURN

```

Listing 7: FINANBIN

```

3000
3000 BD A928 00100 ORG $3000
3003 8E 3110 00110 START JSR $A928 CLEAR SCREEN
3006 BD B99C 00120 INTR LDX #MSG1 FIND THE FIRST MESSAGE
00 00130 JSR $B99C PRINT IT
3009 17 00D8 00140 LBSR SAVE
300C 8E 30F7 00150 LDX #RATE
300F BD BC35 00160 JSR $BC35 SAVE THE RATE
3012 8D 66 00170 BSR CONV1
3014 8E 3120 00180 MONTHS LDX #MSG2 FIND MESSAGE 2
3017 BD B99C 00190 JSR $B99C PRINT IT
301A 17 00C7 00200 LBSR SAVE
301D 8E 30FC 00210 LDX #TERM
3020 BD BC35 00220 JSR $BC35 SAVE THE TERM
3023 8D 68 00230 BSR CONV2
3025 8E 3131 00240 AMOUNT LDX #MSG3 FIND MESSAGE 3
3028 BD B99C 00250 JSR $B99C PRINT IT
302B 17 00B6 00260 LBSR SAVE
302E 8E 310B 00270 LDX #AMNT
3031 BD BC35 00280 JSR $BC35 SAVE THE AMOUNT
3034 8E 3145 00290 LDX #MSG4 FIND MESSAGE 4
3037 BD B99C 00300 JSR $B99C PRINT IT
303A 8E 3106 00310 LDX #VARPV
303D BD BC14 00320 JSR $BC14 VARPV TO FP1
3040 8E 310B 00330 LDX #AMNT
3043 BD BB8F 00340 JSR $BB8F AMOUNT*FP1
3046 17 008B 00350 LBSR PUSING
3049 8E 315C 00360 MORE LDX #MSG5 FIND MESSAGE 5
304C BD B99C 00370 JSR $B99C PRINT IT
304F AD 9F A000 00380 LOOP5 JSR [$A000] WAIT FOR INPUT
3053 27 FA 00390 BEQ LOOP5
3055 81 59 00400 CMPA #'Y
3057 27 CC 00410 BEQ AMOUNT
3059 8E 3173 00420 LDX #MSG6 FIND MESSAGE 6
305C BD B99C 00430 JSR $B99C PRINT IT
305F AD 9F A000 00440 LOOP6 JSR [$A000] WAIT FOR INPUT
3063 27 FA 00450 BEQ LOOP6
3065 81 59 00460 CMPA #'Y
3067 27 AB 00470 BEQ MONTHS
3069 8E 3188 00480 LDX #MSG7 FIND MESSAGE 7
306C BD B99C 00490 JSR $B99C PRINT IT
306F AD 9F A000 00500 LOOP7 JSR [$A000] WAIT FOR INPUT
3073 27 FA 00510 BEQ LOOP7
3075 81 59 00520 CMPA #'Y
3077 27 87 00530 BEQ START
3079 3F 00540 SWI USE RTS IF RUN FROM BASIC
307A CC 04B0 00550 CONV1 LDD #1200
307D BD B4F4 00560 JSR $B4F4 REGISTER D TO FP1
3080 8E 30F7 00570 LDX #RATE
3083 BD BB8F 00580 JSR $BB8F RATE*FP1

```

3086	8E	30F7	00590	LDX	#RATE	
3089	BD	BC35	00600	JSR	\$BC35	FP1 TO RATE
308C	39		00610	RTS		
308D	8E	30F7	00620	CONV2	LDX	#RATE
3090	BD	BC14	00630	JSR	\$BC14	RATE TO FP1
3093	C6	01	00640	LDB	#1	
3095	BD	BD99	00650	JSR	\$BD99	REGISTER B+FP1
3098	BD	8446	00660	LOG	JSR	\$8446 COMPUTE THE LOG
309B	8E	30FC	00670	LDX	#TERM	
309E	BD	BACA	00680	JSR	\$BACA	TERM*FP1
30A1	BD	84F2	00690	EXP	JSR	\$84F2 COMPUTE THE EXPONENT
30A4	8E	3101	00700	LDX	#VARA	
30A7	BD	BC35	00710	JSR	\$BC35	FP1 TO VARA
30AA	C6	FF	00720	LDB	#-1	
30AC	BD	BD99	00730	JSR	\$BD99	FP1-1
30AF	BD	BC5F	00740	JSR	\$BC5F	FP1 TO FP2
30B2	8E	30F7	00750	LDX	#RATE	
30B5	BD	BB88	00760	JSR	\$BB88	FP2/RATE
30B8	BD	BC5F	00770	JSR	\$BC5F	FP1 TO FP2
30BB	8E	3101	00780	LDX	#VARA	
30BE	BD	BB88	00790	JSR	\$BB88	FP2/VARA
30C1	8E	3106	00800	LDX	#VARPV	
30C4	BD	BC35	00810	JSR	\$BC35	FP1 TO VARPV
30C7	39		00820	RTS		
30C8	BD	BDD9	00830	PRINT	JSR	\$BDD9 CHR\$ TO BUFFER
30CB	30	1F	00840	LEAX	-1,X	BUFFER LOCATION -1
30CD	BD	B99C	00850	JSR	\$B99C	PRINT BUFFER
30D0	BD	B958	00860	JSR	\$B958	PRINT A CARRIAGE RETURN
30D3	39		00870	RTS		
30D4	CC	0306	00880	PUSING	LDD	#\$0306 PRINT USING \$#,###.##
30D7	DD	D8	00890	STD	\$D8	
30D9	86	50	00900	LDA	#\$50	
30DB	97	DA	00910	STA	\$DA	
30DD	BD	8FA1	00920	JSR	\$8FA1	PRINT THE NUMBER
30E0	BD	B958	00930	JSR	\$B958	PRINT A CARRIAGE RETURN
30E3	39		00940	RTS		
30E4	9E	A6	00950	SAVE	LDX	\$A6 GET CURRENT POINTER
30E6	34	10	00960	PSHS	X	SAVE IT
30E8	BD	A390	00970	JSR	\$A390	GET INPUT (NO ", " OR "\$")
30EB	9F	A6	00980	STX	\$A6	OUR NEW POINTER
30ED	9D	9F	00990	JSR	\$9F	GET NEXT CHR\$
30EF	BD	BD12	01000	JSR	\$BD12	CONVERT TO FP1
30F2	35	10	01010	PULS	X	GET OLD POINTER
30F4	9F	A6	01020	STX	\$A6	BACK IN LOCATION
30F6	39		01030	RTS		
30F7			01040	RATE	RMB	5
30FC			01050	TERM	RMB	5
3101			01060	VARA	RMB	5
3106			01070	VARPV	RMB	5
310B			01080	AMNT	RMB	5
3110			01090	MSG1	FCC	* ANNUAL RATE - *
311F	00		01100	FCB	0	
3120	20		01110	MSG2	FCC	* MONTHLY TERM - *
3130	00		01120	FCB	0	
3131	20		01130	MSG3	FCC	* AMOUNT FINANCED - *
3144	00		01140	FCB	0	
3145	20		01150	MSG4	FCC	* MONTHLY PAYMENT IS - *
315B	00		01160	FCB	0	
315C	20		01170	MSG5	FCC	* ANY NEW AMOUNT (Y/N)*
3171	0D00		01180	FDB	\$0D00	
3173	20		01190	MSG6	FCC	* ANY NEW TERM (Y/N)*
3186	0D00		01200	FDB	\$0D00	
3188	20		01210	MSG7	FCC	* ANY NEW RATE (Y/N)*
319B	0D00		01220	FDB	\$0D00	
	3000		01230	END	START	

*Using control codes to enhance
your printer's capability*

Printer Diversions and Conversions

By Cray Augsburg
Rainbow Technical Editor

Many computer users report a great deal of confusion about just what their printers are capable of doing and how to make them do those things. And in most cases the manuals offer little or no help to even the intermediate users. "How do I make it do italics?" is a typical question. A more common query here at THE RAINBOW is, "How can I make this program work with my Brand X printer, even though it was written for the Brand Y printer?"

To make a printer perform various tasks — to alter its printing modes and features — we must send it certain *control codes*. These codes are usually simple series of numbers and other characters that the printer understands and interprets via its built-in ROM. For example, to tell the Radio Shack DMP-130 printer to print in italics, we would send the following line from BASIC:

```
PRINT#-2,CHR$(27)CHR$(66)
CHR$(1)
```

Cray Augsburg is RAINBOW's technical editor and has an associate's degree in electrical engineering. He and his wife, Ruth Ann, have two children and live in Louisville, Kentucky. His username on Delphi is CRAY.

Table 1: The ASCII Table

0	NUL	32	Space	64	@	96	'
1	SOH	33	!	65	A	97	a
2	STX	34	"	66	B	98	b
3	EXT	35	#	67	C	99	c
4	EOT	36	\$	68	D	100	d
5	ENQ	37	%	69	E	101	e
6	ACK	38	&	70	F	102	f
7	BEL	39	'	71	G	103	g
8	BS	40	(72	H	104	h
9	HT	41)	73	I	105	i
10	LF	42	*	74	J	106	j
11	VT	43	+	75	K	107	k
12	FF	44	,	76	L	108	l
13	CR	45	-	77	M	109	m
14	SO	46	.	78	N	110	n
15	SI	47	/	79	O	111	o
16	DLE	48	0	80	P	112	p
17	DC1	49	1	81	Q	113	q
18	DC2	50	2	82	R	114	r
19	DC3	51	3	83	S	115	s
20	DC4	52	4	84	T	116	t
21	NAK	53	5	85	U	117	u
22	SYN	54	6	86	V	118	v
23	ETB	55	7	87	W	119	w
24	CAN	56	8	88	X	120	x
25	EM	57	9	89	Y	121	y
26	SUB	58	:	90	Z	122	z
27	ESC	59	;	91	[123	{
28	FS	60	<	92	\	124	
29	GS	61	=	93]	125	}
30	RS	62	>	94	^	126	~
31	US	63	?	95	_	127	rubout

Table 2: Hexadecimal/Decimal Conversions

00	0	20	32	40	64	60	96	80	128	A0	160	C0	192	E0	224
01	1	21	33	41	65	61	97	81	129	A1	161	C1	193	E1	225
02	2	22	34	42	66	62	98	82	130	A2	162	C2	194	E2	226
03	3	23	35	43	67	63	99	83	131	A3	163	C3	195	E3	227
04	4	24	36	44	68	64	100	84	132	A4	164	C4	196	E4	228
05	5	25	37	45	69	65	101	85	133	A5	165	C5	197	E5	229
06	6	26	38	46	70	66	102	86	134	A6	166	C6	198	E6	230
07	7	27	39	47	71	67	103	87	135	A7	167	C7	199	E7	231
08	8	28	40	48	72	68	104	88	136	A8	168	C8	200	E8	232
09	9	29	41	49	73	69	105	89	137	A9	169	C9	201	E9	233
0A	10	2A	42	4A	74	6A	106	8A	138	AA	170	CA	202	EA	234
0B	11	2B	43	4B	75	6B	107	8B	139	AB	171	CB	203	EB	235
0C	12	2C	44	4C	76	6C	108	8C	140	AC	172	CC	204	EC	236
0D	13	2D	45	4D	77	6D	109	8D	141	AD	173	CD	205	ED	237
0E	14	2E	46	4E	78	6E	110	8E	142	AE	174	CE	206	EE	238
0F	15	2F	47	4F	79	6F	111	8F	143	AF	175	CF	207	EF	239
10	16	30	48	50	80	70	112	90	144	B0	176	D0	208	F0	240
11	17	31	49	51	81	71	113	91	145	B1	177	D1	209	F1	241
12	18	32	50	52	82	72	114	92	146	B2	178	D2	210	F2	242
13	19	33	51	53	83	73	115	93	147	B3	179	D3	211	F3	243
14	20	34	52	54	84	74	116	94	148	B4	180	D4	212	F4	244
15	21	35	53	55	85	75	117	95	149	B5	181	D5	213	F5	245
16	22	36	54	56	86	76	118	96	150	B6	182	D6	214	F6	246
17	23	37	55	57	87	77	119	97	151	B7	183	D7	215	F7	247
18	24	38	56	58	88	78	120	98	152	B8	184	D8	216	F8	248
19	25	39	57	59	89	79	121	99	153	B9	185	D9	217	F9	249
1A	26	3A	58	5A	90	7A	122	9A	154	BA	186	DA	218	FA	250
1B	27	3B	59	5B	91	7B	123	9B	155	BB	187	DB	219	FB	251
1C	28	3C	60	5C	92	7C	124	9C	156	BC	188	DC	220	FC	252
1D	29	3D	61	5D	93	7D	125	9D	157	BD	189	DD	221	FD	253
1E	30	3E	62	5E	94	7E	126	9E	158	BE	190	DE	222	FE	254
1F	31	3F	63	5F	95	7F	127	9F	159	BF	191	DF	223	FF	255

Check Account Information System

Not just another checkbook program but a user friendly, menu driven, disk based information system. Keep track of deposits, checks, ATM withdrawals and other account transactions. Define up to 36 categories to monitor expenses. Set up automatic transactions for such items as direct deposits and deductions. Balance your account(s) in minutes! Other features include multi-drive capability, display and print options, check search on any field, edit and delete capability and more.

Reviewed in Rainbow
February 1988 pg. 133
CoCo 3 compatible
Printer optional



After Five Software
P.O. Box 210975
Columbia, SC 29221-0975
(803) 788-5995

Send check or M.O. for
\$34.95 plus \$3.00 S/H.
COD orders: add \$2.00.
(SC res. add 5% sales tax)

Summer special! Order before September 1, 1988 for only \$29.95.

The first code sent to the printer in this case is CHR\$(27). This stands for escape (ESC) and tells the printer a control code is to follow. (Note: Some control codes do *not* require the escape code to be sent first.) The CHR\$(66) code addresses the printer's italics function, and the CHR\$(1) tells the printer to turn this feature on. If we substitute a zero for the one in this last code, we tell the printer to turn its italics mode off.

“Control codes are usually a simple series of numbers and other characters that the printer understands and interprets via its built-in ROM.”

One confusing aspect of printer codes is that they can be sent to the printer in many different forms. For example, we could have sent ASCII character designations in the above example. The following line does this:

```
PRINT#-2,CHR$(27);"B";CHR$(1)
```

Some printers go a step further and allow the user to enter

```
PRINT#-2,CHR$(27);"B1"
```

to accomplish the same task. The ASCII table shown in Table 1 shows that the number 66 can be represented by the uppercase letter B. On the other hand, the ASCII character 1 translates to a numeric value of 49. A little experimentation is usually necessary before you begin to understand these differences and how your printer interprets them.

The control codes used to access the various features of your printer are found in the manual accompanying the printer. They are usually presented in *tabular form* near the back. In addition, I have provided in tables 3 and 4 summarized lists of some of the more commonly used codes. Their presentation allows you to cross-reference codes for

Table 3: Epson codes

Function	Codes	Legend									
		Star NX-10	Star NX-1000	Epson MX-80	Epson FX-80	Epson RX-80	Okidata 190+, 290+ ¹	Panasonic 1080i and 1091i	Citizen 120D	Seikosha SP-1000A	
Underline On	27 45 1	Y	Y	Y	Y	Y	Y	Y	Y	Y	Y
Underline Off	27 45 0	Y	Y	Y	Y	Y	Y	Y	Y	Y	Y
Italics On	27 52	Y	Y	Y	Y	Y	D ³	Y	Y	Y	Y
Italics Off	27 53	Y	Y	Y	Y	Y	D ³	Y	Y	Y	Y
Draft/Normal	27 120 0	Y	Y	N	N	N	D ⁴	Y	Y	Y	Y
Correspondence/NLQ	27 120 1	Y	Y	N	N	N	D ⁵	Y	Y	Y	Y
Pica Pitch	27 80	Y	Y	N	Y	Y	D ⁶	Y	Y	Y	Y
Elite Pitch	27 77	Y	Y	N	Y	Y	D ⁷	Y	Y	Y	Y
Condensed	15 (on) 18 (off)	Y	Y	Y	Y	Y	Y	Y	Y	Y	Y
Elongated On	27 87 1	Y	Y	Y	Y	Y	Y	Y	Y	Y	Y
Elongated Off	27 87 0	Y	Y	Y	Y	Y	Y	Y	Y	Y	Y
Bold On ²	27 69 (27 71)	Y	Y	Y	Y	Y	Y	Y	Y	Y	Y
Bold Off ²	27 70 (27 72)	Y	Y	Y	Y	Y	Y	Y	Y	Y	Y
Unidirectional On	27 85 1	Y	Y	Y	Y	Y	Y	Y	Y	Y	Y
Unidirectional Off	27 85 0	Y	Y	Y	Y	Y	Y	Y	Y	Y	Y
Right Margin Set	27 81 n	Y	Y	Y	Y	Y	D ⁸	Y	Y	Y	Y
Left Margin Set	27 108 n	Y	Y	N	Y	Y	D ⁸	Y	Y	Y	Y
Page Length (Lines)	27 67 n	Y	Y	Y	Y	Y	Y	Y	Y	Y	Y
Paper-Out On	27 57	Y	Y	Y	Y	Y	Y	Y	Y	Y	Y
Paper-Out Off	27 56	Y	Y	Y	Y	Y	Y	Y	Y	Y	Y
6 Lines Per Inch	27 50	Y	Y	Y	Y	Y	Y	Y	Y	Y	Y
8 Lines Per Inch	27 48	Y	Y	Y	Y	Y	Y	Y	Y	Y	Y
Superscript On	27 83 0	Y	Y	Y	Y	Y	Y	Y	Y	Y	Y
Subscript On	27 83 1	Y	Y	Y	Y	Y	Y	Y	Y	Y	Y
Super/Subscript Off	27 84	Y	Y	Y	Y	Y	Y	Y	Y	Y	Y

- 1) Okidata 190+ and 290+ series using IBM Personality Modules.
- 2) Some printer manuals indicate the user should use emphasized while others suggest enhanced.
- 3) Italics on = 27 37 71, Italics off = 27 37 72
- 4) Draft speed = 27 35 49
- 5) NLQ mode = 27 73 51
- 6) Pica pitch = 18
- 7) Elite pitch = 27 58
- 8) Left and right margins are set simultaneously: 27 88 1 r

OWL-WARE

Proven Technology New CoCo 3 Utilities

Great for 512K Systems! From Color Venture and OWL-WARE

PRINTER LIGHTNING

A great print spooler which gives you 44K print buffer from a 128K CoCo and up to 438K (200 pages!) from a 512K CoCo. With this spooler you can run a program while you are printing a file. The spooler does not slow down the computer to any noticeable extent while you are running a second program and no lost characters arise. Baud rates selectable. *Printer Lightning* can reside in memory along with *RAMDISK*!

RAMDISK

Using 512K CoCo 3 you have access to 2 additional disk drives in RAM. All disk commands are supported, and the data are Reset button protected. You can now have up to 5 disk drive capacities on line at once and can assign the ram disks to any drive number. By making the ramdisk Drive 0, all programs which require a lot of drive access will run much faster. You can have the *RAMDISK* in memory at the same time as the *Printer Lightning*!

BACKUP LIGHTNING

This program is the fastest way to make backup copies of your files using a 512K CoCo. You can backup 35, 40, or 80 track disks single or double sided. Both RS and OS-9 disks may be backed up. The original disk is saved to memory and a copy can be made on an *unformatted disk* every 45 seconds! The lightning read, write, format, and verify routines that were developed make this program much quicker than RSDOS or OS-9 for backups. This will become one of your most used programs!

•NEW•NEW•

Only \$19.95 each. 3 for \$39.95.

SPECIAL With our 512K Upgrade (Next page) only \$2. each or 3 for \$5!

Announcing:

The finest graphics/drawing program for the COCO 3!

Da Vinci 3

- 16 colors on screen at one time
- Modify each color from 64 available colors
- Use composite or RGB monitor
- Draw with custom paintbrushes
- Full resolution 320 X 192
- Picture converter for conversion of COCO 2 pictures to COCO 3
- Multiple text fonts
- Accepts input from joystick, X-pad, mouse, or touch-pad
- Boxes, circles, line, paint generation
- Screen dump for Tandy mono and color ink-jet printers, (NX-10 and others pending)
- Sensible price
- No additional hardware required because of course/fine joystick movement modes
- Zoom mode for individual pixel editing
- Great on screen menu which is removable at the touch of a key to allow full screen edit

128K or 512K COCO 3

\$37.95



Super I/O Board for OS-9

Each Board Provides 2 Serial Ports and Centronics Parallel Port
First Board has Real Time Clock and Beeper... With Second Board up to 5 Users

The serial ports are usable up to 19,200 Baud, and the parallel port is a true Centronics standard. Plug into your multi-pak. On CoCo 3, multi-pak must be upgraded. You will have a multi-user system with additional computers or terminals plugged into the serial ports. An OWL hard drive and 512K upgrade are strongly recommended for multi-user systems.

Intro Price... **\$169.**

BOARD 2... \$145.

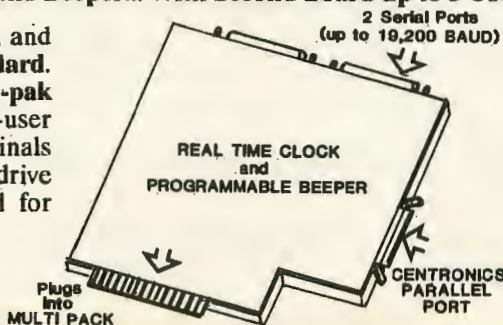

OWL-WARE

P.O. Box 116-A
Mertztown, PA 19539

— ORDER LINES (only) —

(800) 245-6228

(215) 682-6855 (PA)



Proven

On the Razor's Edge of

Basic and OS-9 Hard Drive Systems

Proven Performance for Demanding Home or Business Users

Every hard drive which has been produced by OWL-WARE during the last 3 years is **complete**. A system consists of software, hard drive, controller, heavy-duty power supply, and LR Tech Interface. There are no hidden costs for assembly or testing. When a drive system is ordered, we fully **assemble, test, and burn-in** the system for 3 full days. This ensures dependability and optimum performance.

We have now been supplying CoCo hard drive systems and parts for more than 3 years. This is the longest history in the CoCo market of any system. Some other advertisers are stating that they have one of the most reliable systems for the CoCo *with all of 4 months history in the CoCo hard drive market!* We have reached our position in the hard drive market by providing our customers with a quality product that they (and we) can be proud to own and use.

Because of many requests for a lower price system in kit form, we are now selling a kit of all parts at a significant discount compared to our regular prices. We recommend this kit (or any kits offered by any other supplier) only to those who have experience in electronic assembly and OS-9.

For OS-9 Levels 1 and 2



OWL Hard Drive BASIC 3

There have been several ads in this magazine about BASIC for Color Computer hard drive systems. These ads sometimes only tell a part of the story. Our BASIC system price includes **assembly, testing, and 3-day burn-in** period. We do not require a Multi-pak to operate.

Our hard drive systems are fast, reliable, and reasonable in price. This has been proven by hundreds of users over the past 3 years. We do not have to turn off error checking for speed. We achieve high speed BASIC from a unique indexing method.

The table below will summarize some of the key points about our BASIC hard drive system and two other systems. We believe that we have the best BASIC interface for CoCo hard drives available.

BASIC Hard Drive Systems*

Feature	OWL	B&B	RGB
Drive Portion Available	Entire	Entire(?)	Entire
User Sets BASIC/OS-9 Partitions	YES	Yes	No
Add to Existing OS-9 Drive Without Reformat	YES	Yes(?)	No
Drives 0-3 Hard/Floppy	YES	No	Yes
Built in Park	YES	No	Yes
Speed*	FAST	Fast	Fast

* All feature details are believed to be true at time of writing and are subject to change. We believe that our BASIC hard drives are the fastest due to our indexing method, but all three systems are fast. On ours all BASIC commands work including DSKINI, DSKI\$, and DSKO\$.

Prices: With/Without Hard Drive
\$35./\$79.

10 Meg. 20 Meg. 40 Meg. 80 Meg.

(2 X 40 Meg.)

System Prices: (Includes Hard Drive, Controller, LR Tech Interface, Software. Fully assembled and tested.)

\$469. \$599. \$725. \$1,069.

Kit Prices: (LR Tech System as above but not assembled or tested.)

\$419. \$549. \$659. \$ 999.

Kit Prices: (As above but using Burke & Burke bus adapter)

(na) \$489. \$609. (lower prices)

30 Meg Kit: \$539. (Lowest prices anywhere)

Technology

the Color Computer Frontier

DISK DRIVES



Floppy Drive Systems

The Highest Quality for Service Now and for Years to Come

Use our WHISPER DRIVE for the finest, quietist drive

Drive 0 Systems (Half Height, Double Sided, Direct Drives) **\$219.**

Drive 0 systems complete with drive, controller, legal DOS, cable, case, power supply, and manual

Drive 1 Systems (Half Height, Double Sided, Direct Drives) **\$129.**

New 3.5", 720K Drives for OS-9 with case & Power Supply \$179.

Drive 1 Systems have drive, case, power supply. (You may require optional cable and/or DOS chip to use)

Special for 0/1 Combos (Drives 0,1,2,3) **\$315.**

HALF-HEIGHT DRIVE UPGRADES FOR RS HORIZONTAL CASES

Why only double the capacity of your system when you can triple in the same case? Kit includes: double-sided to fit your case, chip to run both sides of new drive, hardware, and detailed instructions. Easy! Takes only 5 minutes!

Model \$119. Model \$129.
500 501 or 502

All drives are new and fully assembled. We ship only FULLY TESTED and CERTIFIED at these low prices. We use Fuji, YE Data, and other fine brands. No drives are used or surplus unless otherwise stated to you when you order. We appear to be the one of the few advertisers in Rainbow who can truly make this claim. We have 5 years experience in the CoCo disk drive market! We are able to provide support when you have a problem.

Drives 1 Year Warranty

OWL Phones

Order Numbers (only)

1-800-245-6228

1-215-682-6855

Technical Help

1-215-837-1917

OWL WARE Software Bundle

Disk Tutorial/Utilities/Games DISK TUTOR Ver 1.1

Learn how to use your disk drive from this multi-lesson, machine language program. This tutor takes you through your lessons and corrects your mistakes for a quick, painless disk drive introduction. (This professionally written tutor is easily worth the bundle's total price.)

OWL DOS

An operating system that gives faster disk access and allows the use of double-sided drives. Corrects a floating point number error on early CoCo systems.

COPY-IT

Quickly copies selected programs between disks. A wild card option selects groups of programs to copy.

VERIFY

Verifies reading of each sector. Bad sectors are listed on the screen.

2 GAMES

We will select 2 games from our stock. These sold for more than \$20 each.

If sold separately this is more than \$125 worth of software!!

Do not mistake this software with cheap, non-professional "Public Domain" software which is being offered by others. All of this software is copyrighted and professional in quality. The tutor is unique with us and has helped thousands of new users learn their disk drive.

**only \$27.95
(or even better)
only \$6.95 with
any Disk Drive Purchase!!**

Our prices include a discount for cash but do not include shipping.

OWL-WARE has a liberal warranty policy. During the warranty period, all defective items will be repaired or replaced at our option at no cost to the buyer except for shipping costs. Call our tech number for return. Return of non-defective or unauthorized returns are subject to a service charge.

OWL-WARE
P.O. BOX 116
Mertztown, PA 19539

your printer to others. Armed with this information, a little common sense and a moderate amount of time, you can modify BASIC programs from THE RAINBOW that were written for other printers, as well.

Not counting LaserJets and certain other printers, we come into contact with three basic types of control codes used by printer manufacturers: Epson Standard codes, IBM codes and Tandy codes. For the most part, the Epson and IBM codes are identical. To see some of the differences, however, compare the Okidata (IBM mode) codes presented in Table 3 with those for the other printers. The largest schism we see is between the Tandy-type codes and the other two. More work is usually required in converting between these types.

“One confusing aspect of printer codes is that they can be sent to the printer in many different forms.”

To convert a BASIC program for your printer, first go through the listing line by line and determine which lines contain control codes and what those codes are. I find the best way to do this is to look for lines that contain PRINT#-2. In some cases the program may send character strings (CHR\$()) that are not control codes, but simply print data. For example, instead of using PRINT#-2, "*" to print an asterisk, the programmer might have chosen to use PRINT#-2, CHR\$(42). Watch for this situation, and experiment to find the differences between control codes and data to be printed.

If you know for which printer the program was written, you can compare the codes you find and quickly replace the codes with those for your own printer. Keep in mind that you may have to refer to the ASCII and Hex tables (tables 1 and 2) in correctly determining the proper codes and their corresponding functions.

If you don't know which printer the author used, your work will be a little harder. You can compare the codes you find with those given in these tables to determine what function is being used. Then cross-reference the code for your printer.

In addition to information about various dot matrix printers, I have included the codes for the Radio Shack DWP-210 and DWP-230 printers (Table 5). As expected, these daisy-wheel printers don't offer as much control to the user. Also, Table 6 shows the various codes used for the Radio Shack CGP-220 Inkjet printer.

Some control codes are standard for nearly every printer made. These codes control basic printhead and platen movement and are listed below.

CHR\$(8)	backspace
CHR\$(10)	forward linefeed
CHR\$(12)	formfeed
CHR\$(13)	carriage return

Table 4: Radio Shack DMP codes

Function	Codes	Radio Shack DMP-130	Radio Shack DMP-105/106
		Y	Y
Underline On	15	Y	Y
Underline Off	14	Y	Y
Italics On	27 66 1	Y	N
Italics Off	27 66 0	Y	N
Draft/Normal	27 19	Y	N
Correspondence/NLQ	27 18	Y	N
Pica (10 CPI)	27 19	Y	Y
Elite (12 CPI) ¹	27 23 (27 29)	Y	Y
Condensed (16.7 CPI)	27 20	Y	Y
Elongated On	27 14	Y	Y
Elongated Off	27 15	Y	Y
Bold On	27 31	Y	Y
Bold Off	27 32	Y	Y
Unidirectional On	27 85 1	Y	Y
Unidirectional Off	27 85 0	Y	Y
Right Margin Set	27 82 n	Y	N
Left Margin Set	27 81 n	Y	N
Page Length (inches)	27 52 n	Y	N
Paper-Out On		N	N
Paper-Out Off		N	N
6 Lines Per Inch	27 54	Y	Y
8 Lines Per Inch	27 56	Y	Y
Superscript On ²	27 83 0	Y	Y
Subscript On ²	27 83 1	Y	Y
Super/Subscript Off ²	27 88	Y	Y

- 1) Second code shown is for NLQ Elite pitch.
- 2) Super- and subscripts not supported on the DMP-105

Table 5: Radio Shack DWP printers

Function	Codes	DWP-210	DWP-230
Underline On	15	Y	Y
Underline Off	14	Y	Y
Pica (10 Pitch)	27 15	Y	Y
Elite (12 Pitch)	27 14	Y	Y
Bold On	27 31	Y	Y
Bold Off	27 32	Y	Y

As a final note, you will undoubtedly encounter some codes for which your printer offers no direct equivalent. For example, your particular printer may not support super- and subscript printing. However, if it supports half-reverse and half-forward linefeeds, you will find these codes can be combined to emulate super- and subscripts. Trial and error is often helpful in altering programs. There may also be times when your printer cannot duplicate a particular function. In these cases it is up to you to determine whether you leave the code out altogether or try a different approach.

Based on the difficulties often encountered in converting codes for various printers, I ask that all programmers who submit material to THE RAINBOW follow certain guidelines. Please include a table with your submission detailing the printer control codes used by your program, the functions they perform and in which lines they appear. Finally,

Table 6: Codes for the CGP-220

CHR\$(8)	Backspace in text mode.
CHR\$(11)	Reverse Line Feed in text mode.
CHR\$(17)	Select Text Mode.
CHR\$(18)	Select Graphic Mode.
CHR\$(29)	Change color in Text Mode.
A	Reset
Cnumber	Change color. <i>number</i> from 0-3.
Ddestination	Draw from current coordinate to specified position.
H	Move pen to current origin w/o drawing.
I	Sets new origin.
Jdestination	Draw a line from current pen location <i>x</i> steps to the right and <i>y</i> steps up.
Ltype	Change line type (0-15). 0 is a solid line. 1-15 draw dashed lines.
Mx,y	Move without drawing to location <i>x</i> steps right (left) and <i>y</i> steps up (down) of present origin. <i>Absolute</i> .
Pcharacters	Print characters in Graphic Mode.
Qdirection	Change print direction. <i>direction</i> is 0-3. 0=normal, left-to-right; 1=top-to-bottom; 2=upside-down; 3=bottom-to-top.
Rx,y	Move without drawing from present location to location <i>x</i> steps to the right (left) and <i>y</i> steps up (down). <i>Relative</i> .
Ssize	Specifies size of printed characters drawn with P command.
Xaxis,step, intervals	Draw a coordinate axis from present location in direction specified by <i>axis</i> using increments of <i>step</i> and marking <i>intervals</i> of them.

let the reader know exactly which printer your program is designed for. With this information and the printer manual, RAINBOW readers should be able to make quick work of deleting your codes and replacing them with those for their system.

Due to the complexities and differences involved, I have avoided discussion of graphics control codes and the transfer of graphics data. This information can be used as a stepping stone, however, if you are interested in learning more about printers. ☺

Lyra

Lyra is the premier music composition program that lets your CoCo talk to your MIDI synthesizer. You can't find a program that is easier to use! It is as simple as "pick up a note and put it on the staff". Lyra is also very powerful. Individual notes can easily be changed or blocks of music may be copied or deleted. Create full sounding music with 8 parts using a range of note values from whole to 64ths with any combination of dots, triplets, or ties. Change volume, tempo, and instruments anywhere in the music. Set synthesizer configurations or even upload new instrument patches from the score! Now includes LyraPrint, which will print your masterpiece on a dot matrix printer (Epson, Gemini, Radio Shack, and Oki Data 92), and a cable to connect the CoCo to a MIDI synthesizer. Requires a disk drive, a mouse and any version of the Color Computer. \$59.95

Lyra Lybrary

Here's a collection of music that will please any taste! Over 11 disks packed with a variety of music that will exercise your MIDI synthesizer. Enjoy music from Bach to the Beatles. Edit the music on Lyra or just play it using the "jukebox" type program included. Requires a disk drive, a mouse, and a Lyra MIDI cable. Send a SASE for a complete listing of available titles. Each disk \$14.95

Rulaford Research

P.O. Box 143
Imperial Beach, CA 92032
(619) 690-1181 (evenings 6-10 PT)

We're a new company here to give you the best in music products for the Color Computer. We think you will like what we have to offer. If you have a new music program or ideas or comments, let us know! Inquire about our other products.

Ordering information: Send a check or money order; sorry, no credit cards. COD is OK. Shipping and handling within continental USA included in price. CA residents add 6% tax.

Isolating and repairing keyboard problems

Are You Missing Something?

By Roger D. Dowd

I like to experiment with many hardware modifications and do all of my own repairs on my Color Computer. This normally involves removing and re-inserting the keyboard, causing a lot of wear and tear on the delicate keyboard connector.

The keyboards (CoCo 1 'F' Board and later) for Radio Shack's Color Computers are made of a very fragile plastic membrane, with thin conductor runs on one side. The conductor runs are easily damaged if scratched or overflexed. Once damaged, the runs cannot be repaired by soldering, as the heat from the soldering iron melts the plastic. Replacement keyboards can be purchased for between \$5 and \$50, although the \$5 keyboards that were discontinued by Radio Shack a year or two ago are getting more difficult to find.

The procedures described in this article require that some tests be performed with the computer's cover removed and the power on. Hazardous and potentially lethal voltages exist inside the computer around the power supply and on-off power switch. Be extremely careful around this area of the computer. The rest of the computer contains very low voltages, but rela-

tively high current. Remove any jewelry from your wrists and hands to avoid personal injury from shock or burns and possible damage to the computer. Every effort has been made to provide accurate information and safe procedures. Neither the author or the publisher will be held liable for any injuries to person or damage to equipment. Be aware that removal of the computer cover and subsequent modification or repairs will void any existing warranties.

Before I explain how to repair the keyboard, it is important to first explain that keyboard problems can appear from different sources. The first, as mentioned above, is due to stress and abuse of the keyboard connector. The other is from a faulty Peripheral Interface Adapter (PIA). If you have never taken your computer apart or it has been some time since you had it apart, and you suddenly develop keyboard trouble, suspect a faulty PIA.

PIA trouble can cause such symptoms as missing characters, erroneous characters appearing from seemingly nowhere, intermittent key bounce or a dead keyboard. The easiest way to check for a defective PIA is to simply replace the suspect PIA with a known good one. You will need to refer to the technical reference manual for your particular model CoCo to find which PIA to replace. Always use an exact replacement.

On the newer model CoCos (CoCo 2B, CoCo 3s), the PIA chips are sol-

dered directly to the board. To remove the PIA chips from the later model CoCos, you will have to carefully desolder the chips with a desoldering tool and desolder wick. (Note: This is a job for someone who is skilled in soldering and desoldering integrated circuits.) Before reinstalling the PIA chip, solder in a socket first, then plug in the PIA chip. Any time you do any modification or repair where you must desolder a chip, solder in a socket first before you reinstall the chip. This will save you a lot of aggravation later, as well as wear and tear on the computer circuit board.

To determine which run or line is open, type in the following jingle exactly as it is written: The quick brown fox jumped over the lazy dog's back 0123456789. This jingle will test the entire keyboard matrix. Make note of all the characters that are missing. Looking at Figure 1, you will see 16 lines coming from the keyboard matrix. Find the line that all of the missing characters have in common. For example, on my keyboard the G, O, W, space bar and 7 characters were missing. All of these keys have Line 16 in common. If the letters P, Q, R, S, T, etc., had been missing, then Line 4 would have been defective.

To repair a damaged connector you will need to purchase Loctite's "Quick Grid" Rear Window Defogger Repair Kit, Part No. 15067, available for about \$7 at most hardware and auto parts stores. The heart of this kit is a very tiny bottle of highly conductive paint. Be-

Roger Dowd (WA4QAS) is an electronics technician and an advanced class amateur radio operator. His hobbies include packet radio, computers, and building and experimenting with all types of electronic projects.

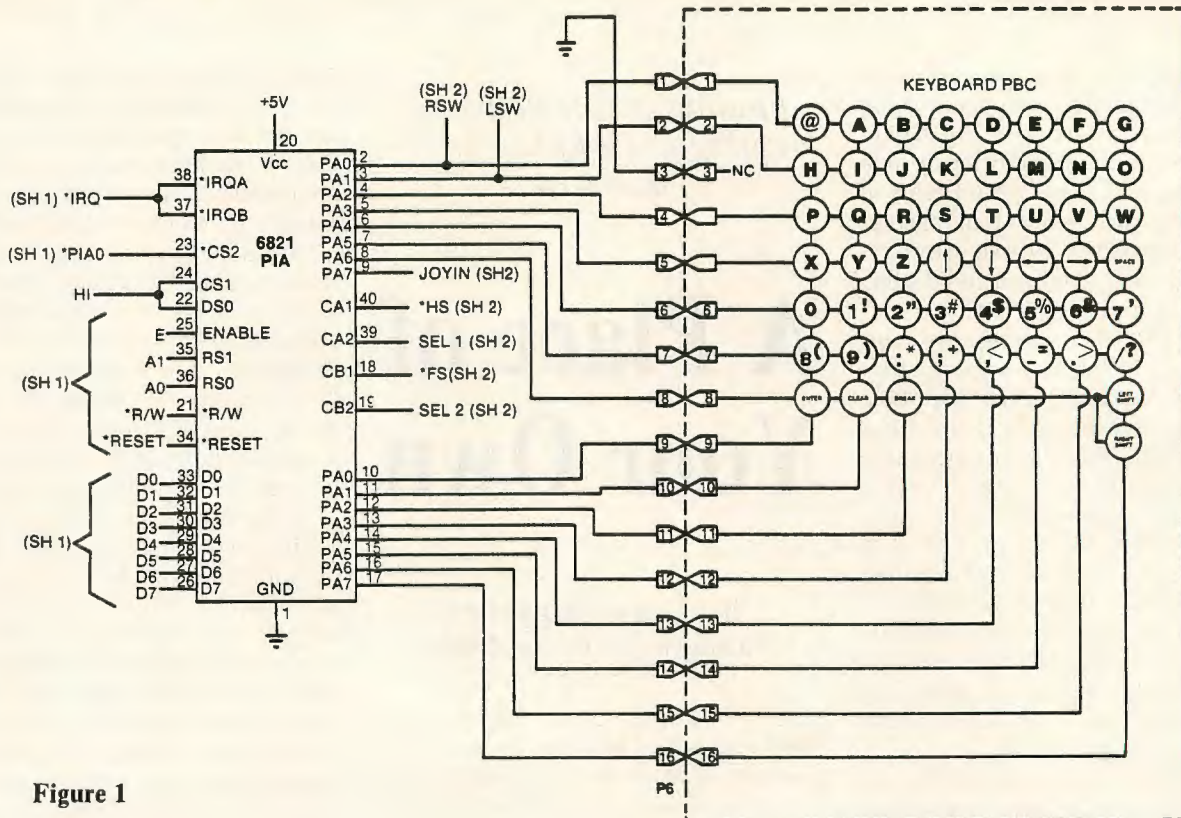

Figure 1

fore you use the paint, shake the bottle very vigorously to get the conductive material to mix with the liquid medium. The paint dries extremely fast, so keep the lid on the bottle whenever you are not actually using it. Because the tiny bottle is so expensive I recommend not using the brush normally supplied with the kit, but straightening a paper clip and using that instead. This will prevent too much of the precious paint from being wasted on the brush. Carefully dip one end of the paper clip into the paint until a small amount of paint has collected on the end of the clip. Dot the paint gently onto the break in the run, making sure to overlap both sides of the break. It will take only a minute or two to dry. Once it has dried, repeat the process two or three more times to get a good coat built up and to ensure good conductivity. Try not to get any of the paint on any of the neighboring runs. After the final coat has been applied, wait about five or 10 minutes for the paint to completely dry. Gently scrape any excess paint from each side of the run with an X-acto knife.

Measure the repaired run for conductivity. If you don't have good conductivity, you will have to scrape off the old paint and repeat the entire process. Failure to get good conductivity is most likely due to not shaking the paint well

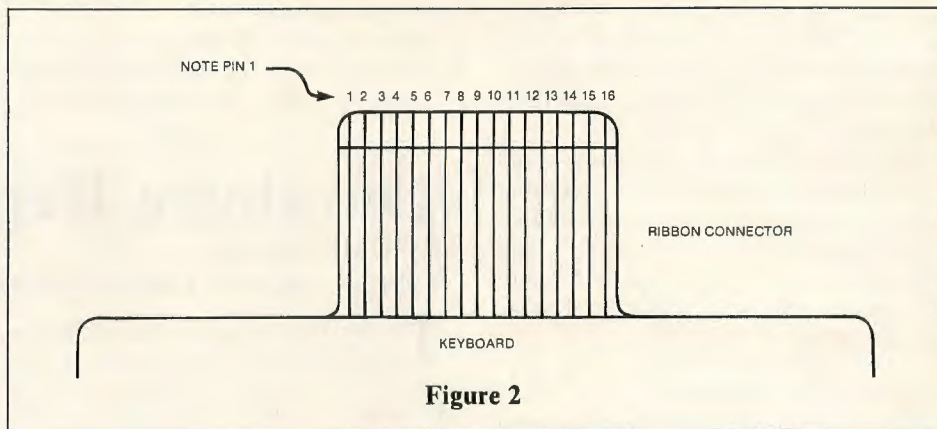

Figure 2

enough. You *must* shake the paint bottle *vigorously!* One of my keyboards had excessive run damage, with one run almost entirely destroyed. I repainted nearly the entire run and restored the keyboard to full use. Although the price of the repair kit may seem expensive, remember that it can have other uses around the home or shop. This is especially true if you etch and build many of your own electronic projects, as I do.

If a break or tear in the run is not obvious, determine if the problem is a spread pin by turning the computer on. With a small, blunt metallic probe, such as a probe of an ohm meter, gently touch the suspect socket pin and keyboard connector run at the point (in the first example, Pin 16) where the two meet.

At the same time, type in one of the characters that was missing. If the key suddenly begins to work but then just as suddenly quits working when the probe is removed, your problem is most likely a spread pin inside the motherboard socket. This may be fixed by removing the keyboard and gently and carefully squeezing the socket together with a pair of pliers. If that doesn't work, the socket may have to be replaced. A replacement socket may be ordered from Tandy National Parts Center.

(Questions or comments regarding this project may be directed to the author at 205 Williams Drive, Bonaire, GA 31005. Please enclose an SASE when requesting a reply.)

Recently we have been getting a lot of requests for help in using various aspects of the CoCo SIG. While we don't mind offering help when we can, it is time-consuming and occasionally somewhat frustrating, especially when the information requested is already available to all users in the Help section of the SIG.

At the CoCo SIG menu, simply enter HELP; you will be taken to a special SIG section that contains several user help files. To see what files are there, enter SCAN or SC. You will see a list containing many help files. These are duplicated in Figure 1. To read a specific file just enter its number at the Help> prompt. For example, to learn how to download files, enter a 40 at the Help> prompt.

Handling of the help files is done by Jim Reed (JIMREED). Jim has created most of the files during his tenure as SIG Manager, and he is continually adding more files to the list.

Using the Help section of the SIG will eliminate sometimes time-consuming correspondence back and forth with the SIG staff. In many cases, a simple question can turn into 10 or 12 letters in Mail. Obviously, we would like to avoid this if at all possible. We understand that it isn't always possible, though.

If your question is still unanswered after checking the Help files, contact Marty Goodman (MARTYGOODMAN), Don Hutchison (DONHUTCHISON), Jim Reed or me (CRAY) via Mail or Forum. We will do our best to help you solve the problem.

Workplace in Workspace

One of the most useful and powerful areas of Delphi is the Workspace area. At the same time, it is often the most unused area. Many users, especially newer ones, are easily intimidated by Workspace — or they just don't understand all the power it gives them. It doesn't take an interested user long to find out that in order to upload a file, it must be done from within this area.

Every Delphi user has a personal storage area set aside on Delphi's com-

Cray Augsburg is RAINBOW's technical editor and has an associate's degree in electrical engineering. He and his wife, Ruth Ann, have two children and live in Louisville, Kentucky. His username on Delphi is CRAY.

Finding online help and creating a workplace in the database

A Place of Your Own

By Cray Augsburg
Rainbow Technical Editor

puters. This area can be used to store private messages and files. In fact, when you receive Mail and file it online, it is stored in a special mail file in your own Workspace. Other users cannot get into your Workspace unless they use your username and password.

You can get to Workspace from two different places in the CoCo SIG (or any SIG for that matter). Just enter WORK-

SPACE or WD at the CoCo SIG prompt or at any database prompt. When you see the WS> prompt on your screen, enter a question mark; you will see the commands available to you in this area. These commands are listed in Figure 2.

To find out what files are presently stored in your Workspace, enter DIRECTORY or CATALOG. Just as with abbreviations elsewhere on Delphi, these commands can be shortened to DIR or CAT, respectively. While the DIR command doesn't appear in the list of available commands, it is there for those who are more comfortable using it.

If you have used the CoCo SIG for a while and have filed much Mail, you may have several files ending with an extension of .MAI when you do a directory of your Workspace. Most likely, you won't be doing any manipulation of these files from within Workspace — and they do tend to get in the way in the directory listing. To get a better-looking directory output, enter DIR / EXCLUDE=* .MAI at the WS> prompt.

Files in Workspace each have a filename, a three-character extension and a version number. The filename and extension should be self-explanatory to most users. The version number, however, may cause some confusion for

Database Report

By Don Hutchison

Rainbow CoCo SIG Database Manager

This has been a very busy month for the CoCo SIG, with the greatest amount of action occurring in the Graphics and Utilities and Applications topics of the database.

OS-9 Online

In the General topic of the database, Kevin Darling (KDARLING) posted a text file describing a method for running *Sub Battle* under *Multi-View*. The method is also applicable to other programs that require a VDG screen to operate.

In the Applications topic of the database, Dennis Weldy (OS9ER) uploaded SCREEN PAINTER, a utility for setting up the screen form to your liking with *Sculptor*. Steve Clark (STEVECLARK) posted a revised text search and find utility that reads filenames from the standard input rather than from a fixed filename. Steve also uploaded a menu choice application program for Level II that allows the creation of mouse- or joystick-controlled applications.

In the Utilities topic of the database, Brian Wright (POLTERGEIST) posted a utility using English-language variables and decimal numbers that is a replacement for the DISPLAY command. Kevin Darling, with the kind permission of Ron Lammardo, posted *Shell+* (Version 1.2) for OS-9 Level II. *Shell+* is designed as a replacement for the current shell on Level II CoCo 3s. It features some fixes for the previous version, a programmable prompt, shell scripts in the current execution directory and a few other neat things. Bruce Terry (THEMAGE) uploaded both an Icon and a font editor to run under Wind-Int.

In the Device Drivers topic of the database, Greg Law (GREGL) gave us five VDG device descriptors, called V0 through V4, which can be used along with Term _Win and windows. Ken Schunk (KENSCHUNK) posted a driver that cures a problem in the VDG driver supplied with the developer's pack. The driver was

written by Volney Larowe of Saratoga Springs, NY. Brian Wright sent us a device driver that partitions a CoCo 3's 512K memory into a fast RAM disk.

In the Patches topic of the database, **Michael Washburn** (COMPZAP) posted PGPATCH, a text file describing how to patch PHANTOMGRAPH to work with Star Gemini printers (10x, 15x and possibly others), using a MODPATCH script (included) or by using a IPATCH.

In the Graphics and Music topic of the database, **Mark O'Pella** (MDODELPHI) uploaded an original composition done using *Umuse*.

CoCo SIG

In the General Information topic of the database, I (DONHUTCHISON) uploaded a

humorous document concerning some of the not-too-obvious benefits of going to RAINBOWfest, while **Marty Goodman** (MARTYGOODMAN) posted two informative reports about the Chicago RAINBOWfest as it was happening. **Roger Bouchard** (HARBIE) posted a text file describing the various alternatives for phone users in accessing the information services. Roger also uploaded several comic files for the amusement of SIG members, as well as some interesting commentaries concerning a pirate BBS and the effect of plastics on the environment. I also posted some humorous files passed to me by Rick Adams from UseNet concerning hotel soap and more of the light bulb trivia.

In the CoCo 3 Graphics topic of the

database, **Orman Beckles** (ORMAN) uploaded his utility called Super XL256 Mach I, which is a new version of Roger Bouchard's XL256. Orman's version allows the user to load a digitized picture, alter the horizontal and vertical position, change the colors and then save the resulting picture in *CoCoMax 3* format. **Heath Dingwell** (OS9K1D) uploaded several nudes in *CM3* format, his favorite *CM3* picture viewer, some *CM3* pictures from popular James Bond films and some detailed pictures of sports cars. **Donald Ricketts** (STEVEPDX) uploaded a palette changer utility for digitized *CM3* images. Roger Bouchard posted an upgrade for his popular XL256 utility for converting digitized images to *CM3* format, as well as a revised version of his demo program for MGE

serious users unless they learn to understand them. We will hold off discussion of version numbers until we have some files to work with.

Creating a File

To write or build a text file in your Workspace, you will use the CREATE command. Enter CREATE *filename* at the WS> prompt. For this example, use TEST1.TXT as the filename. When Delphi is ready for you to write the text

file, it will tell you to enter your text. It also explains your options of using CTRL-Z to save the file or CTRL-C to abort the creation process. Now type the following lines, pressing ENTER after each:

```
THIS IS MY FIRST LINE.  
THIS IS MY SECOND LINE.  
THIS IS THE FINAL LINE.
```

When you have pressed ENTER after

the last line, press CTRL-Z and your file will be saved. Now when you enter DIR, you should see TEST1.TXT;1 as one of the entries. Let's go ahead and create a second file. Call this one TEST2.TXT. Enter each of the following lines in this new file:

```
SECOND FILE, FIRST LINE.  
SECOND FILE, SECOND LINE.  
SECOND FILE, FINAL LINE.
```

Figure 1: List of help files available in Help section of CoCo SIG.

- | | |
|----------------------------------|-----------------------------------|
| 1 APPOINTMENT CALENDAR | 40 HOW TO DOWNLOAD FILES |
| 2 AUTO-HANGUP ON TELENET | 41 LINEFEEDS |
| 3 CHANGING YOUR PASSWORD | 42 MENUS CAN BE ELIMINATED |
| 4 COCO COMPOSER HELP | 43 MORE? PROMPT CAN BE ALTERED |
| 5 CONFERENCE HELP | 44 NEW DELPHI BOOK OUT |
| 6 CONFERENCE HINT | 45 NEW SIGWARE, 12/15/86 |
| 7 CONFERENCE: /DIR & /DISPLAY | 46 NEW SIGWARE, 8/1/87 |
| 8 CONTROL CODES | 47 NO SUCH USER |
| 9 CONTROL-O RESPONSIVENESS | 48 PAGERS ARE TOO IMPATIENT |
| 10 CONTROL-Z IS HANDY | 49 PROFILE NEEDED FROM YOU! |
| 11 DATABASE HINT, LEADING SPACES | 50 QUICK (TRUE) BREAK |
| 12 DATABASE STANDARDS | 51 QUIT COMMAND IN FORUM |
| 13 DATABASE UPDATE 9-15-87 | 52 RAINBOW DATABASE & CASSETTE US |
| 14 DECEMBER DELPHI NEWSLETTER | 53 RAINBOW ON TAPE DATABASE |
| 15 DEFAULTING INTO THE COCO SIG | 54 RAINBOW ON TAPE DOWNLOADING |
| 16 DELPHI COMMAND CARD | 55 RAINBOW ON TAPE ORDERS |
| 17 DELPHI: THE OFFICIAL GUIDE | 56 RAINBOW SUBSCRIPTION PROBLEM |
| 18 DISABLING CALL WAITING | 57 READING NONSTOP OVER RANGE |
| 19 DOT COMMANDS IN FORUM | 58 ROLL THEM BONES |
| 20 ECHO CAUSES DOUBLE LETTERS | 59 SETTING SETTINGS |
| 21 EDIT MODE | 60 SUBMISSIONS FOR RAINBOW PUBLIC |
| 22 EDITING IN FORUM HINT | 61 SUBMITTING A FILE |
| 23 EDITOR: PICK FROM TWO | 62 SURCHARGED DOWNLOADS |
| 24 EDITOR:OLDIE COMMANDS | 63 SURCHARGED FILES EXPLAINED |
| 25 ELIM. MAIL IN WORKSPACE DIR | 64 TELENET LOGON PROCEDURE |
| 26 ENT: TO SEE LAST ENTRY | 65 THE /NAME COMMAND IN CONFERENC |
| 27 FOLDERS ENHANCE MAIL FACILITY | 66 TIMEOUT CAN BE VARIED |
| 28 FORUM CHANGES, 11/8/86 | 67 TIP FOR PRINTOUTS |
| 29 FORUM CHANGES, 12/29/86 | 68 TO SKIP A SECTION |
| 30 FORUM COMMAND LIST | 69 TO STOP OUTPUT |
| 31 FORUM EDITING HINT | 70 TRY /TIME |
| 32 FORUM ENHANCEMENT, 1/5/86 | 71 UNWARRANTED "NO SUCH USER" MES |
| 33 FORUM HELP | 72 USERNAME CAN BE CHANGED |
| 34 FORUM READING NONSTOP | 73 USING THE MEMBER DIRECTORY |
| 35 FREE UPLOAD TIME AVAILABLE | 74 VOTE IN OUR POLLS |
| 36 GETTING INTO MAIL QUICKLY | 75 WHEN YOU ARE PAGED |
| 37 GO COMMAND | 76 XMODEM DOWNLOADING |
| 38 HANDLES ARE HANDY | 77 XMODEM UPLOADING |
| 39 HELP IS ALWAYS AVAILABLE | 78 YOUR OWN NAME NEEDED |

pictures. The CoCo Gallery pictures for the months of February through July 1988 are now available, also. (NOTE: The Gallery pictures are now available online at approximately the same time as the RAINBOW ON TAPE and DISK programs from each monthly issue of THE RAINBOW. They are posted in the appropriate topic of the database, either CoCo 3 Graphics or Classic Graphics.) **Mike Stute** (GRIDBUG) sent us a clever BASIC picture of a cat as he tears up his owner's curtains! **Billy Hambric** (SNOOPYDOG) sent us some digitized scenes from the motion picture *Beauty and the Beast* and a digitized shot from *Star Trek*. **Mike Andrews** (MANDREWS) sent us a text file containing the file specifications for the *MacPaint* pictures. **David Brown** (NASAI) sent us a utility called PICUP for moving a picture upward on the Hi-Res screen.

In the Utilities and Applications topic of the database, **Dave Stampe**, author of *CoCo Max 3* and other fine programs, has placed *Colour Key* in the database of the CoCo SIG! Dave gave us the programs while attending the Chicago RAINBOWfest. *Colour Key* is a powerful BASIC programmer's utility for the Color Computer 1 and 2 that incorporates many useful programming tools such as full screen editing, repeating keys, user-definable keys, automatic line number generation, full error and break key trapping, reverse video option, compatibility with the CoCo 3 in CoCo 2 mode and dozens of other handy features that no

CoCo programmer should be without. A version of *Colour Key* is available for the CoCos 1 and 2 and the CoCo 3. Dave also provided us with *FFT*, a program designed to perform FFTs and IFFTs on a set of 256 data points. An FFT turns a waveform into a frequency/power graph, and an IFFT does the opposite. You could use the FFT to sample sounds, get the response of a filter from its impulse response or synthesize the response of a filter or a waveform from a set of frequencies and phases with the IFFT. **Richard Ortman** (RAO) sent us a filing system for comic book collections that also features a sort routine. **Ken Halter** (KENHALTER) uploaded a set of programs that may be used to sort multiple arrays. **David Mills** (DAVIDMILLS) uploaded an encryption utility for scrambling any or all of the files on a disk using a user-supplied code, as well as a 512K disk backup utility. **John Barrett** (JBARRETT) sent us his *Deed Checker* program for realtors, and **Alan DeKok** (ALANDEKOK) posted his *Fastdrive* utility that enables the CoCo 3 to work at double speed during all disk access. Alan included the *EDTASM+* source code as well as versions for both 1.0 and 1.1 disk ROMs.

In the Hardware Hacking topic of the database, I posted a lengthy treatise on the subject of lightning protection as discussed on another SIG. SIGop Marty Goodman was also involved in this roundtable discussion. Kevin Darling uploaded a text file that describes a fix for the problems involved with the Tandy FD 502 second

drive kit.

In the Games topic of the database, **Zack Sessions** (ZACKS) uploaded an *Othello* game for the CoCo 3, a *Blackjack* game, and a *Hammurabi* game. Zack also posted Mike Ward's routines for putting the ROM pack game *Springster* on disk. John Barrett posted a *Star Frontiers* character sheet utility.

In the Classic Graphics topic of the database, **Mark Garbarini** (F19) sent us his original drawings called *Pentagram* and *Tiger*. **Andy Duplay** (KB8BMN) uploaded a Hi-Res picture of a Bengal tiger, a conversion utility for MacIntosh pictures to *CoCo Max* format and several digitized female nudes.

In the Music and Sound topic of the database, Mike Stute sent us *The CoCo Cat Shuffle*, *Rainbow in the Dark*, and a short article about getting a better electric guitar sound from your synthesizer. **Tony Zamora** (TONYZAMORA) uploaded his *Musica 2* file converter, which produces stand-alone files from *Musica*'s MUS files. **George Hoffman** (HOFFBERGER) sent us three Pink Floyd songs for *Lyra*.

In the Product Reviews and Announcements topic of the database, **Eddie Kuns** (EDDIEKUNS) uploaded his review of *Data-Pack* versus *V-Term* from Gimmesoft. **Jim Goettig** (JGMG) posted an announcement about the CoBBS system for the CoCo 3.

That's it for this month. As you can see, there's plenty of good material available on the Rainbow CoCo SIG. Hope to see you all online! □

Make sure to press CTRL-Z after the last line to save the file. Great! Now we have two files in Workspace. And we can get down to learning a little more about how to manipulate files in Workspace.

Moving Files Around

First, let's try copying files with the COPY command. Enter COPY TEST1.TXT TESTCOPY.TXT. When you do a directory, you will see the new file TESTCOPY.TXT as an entry. The COPY command makes an exact duplicate of the first filename listed in the command line and calls this new file by the second filename listed. Note that the command and each of the filenames are separated with spaces. Play around with this if you want before we move on to the APPEND command.

Putting 'em Together

There is a very quick way to combine two files in Workspace. Simply enter APPEND filename1 filename2. This command adds the text from filename1 to the end of the text in filename2. When

this is done, filename1 is unharmed — it has been neither deleted nor changed. The contents of filename2, however, have been changed. Not to worry, though. The original filename2 is still intact. What happens is that Delphi makes a copy of filename2 and adds the text from filename1 to it. This new file has the same name as filename2, but a new version number. Let's give it a try.

Figure 2: Workspace Commands

APPEND to File	PUBLISH File
CATALOG Files	PURGE Old Versions
COPY File	RENAME File
COUNT Words	SETTINGS
CREATE File	SUBMIT File
DELETE File	UNPROTECT File
DOWNLOAD File	UPLOAD File
EDIT File	KERMIT-Server
EXIT	Other Commands
HELP	New Features
LIST File	

Enter APPEND TEST2.TXT TESTCOPY.TXT. After Delphi finishes its work, do a directory. You should see

that the following files are now in your Workspace:

```
TEST1.TXT;1
TEST2.TXT;1
TESTCOPY.TXT;1
TESTCOPY.TXT;2
```

To find out what is in these files, we can use the list command. Simply enter LIST, followed by the name of the file you want listed. You don't have to include the version number if the file you want listed is the latest version. If, however, you want to see the contents of TESTCOPY.TXT;1, the original file, you will have to enter the version number. Commands in Workspace always default to the most recent version, i.e., the one with the highest version number.

That's about all we can cover this month. Next month I hope to give some coverage to some of the uses of files in Workspace. Can you imagine sending one letter to hundreds of people on Delphi at the same time without having to retype it every time? It's actually very easy to do, and we'll be discussing that next time. See you then! ☺

New Low Prices! New Products!

HDS Floppy Drive Controller Board

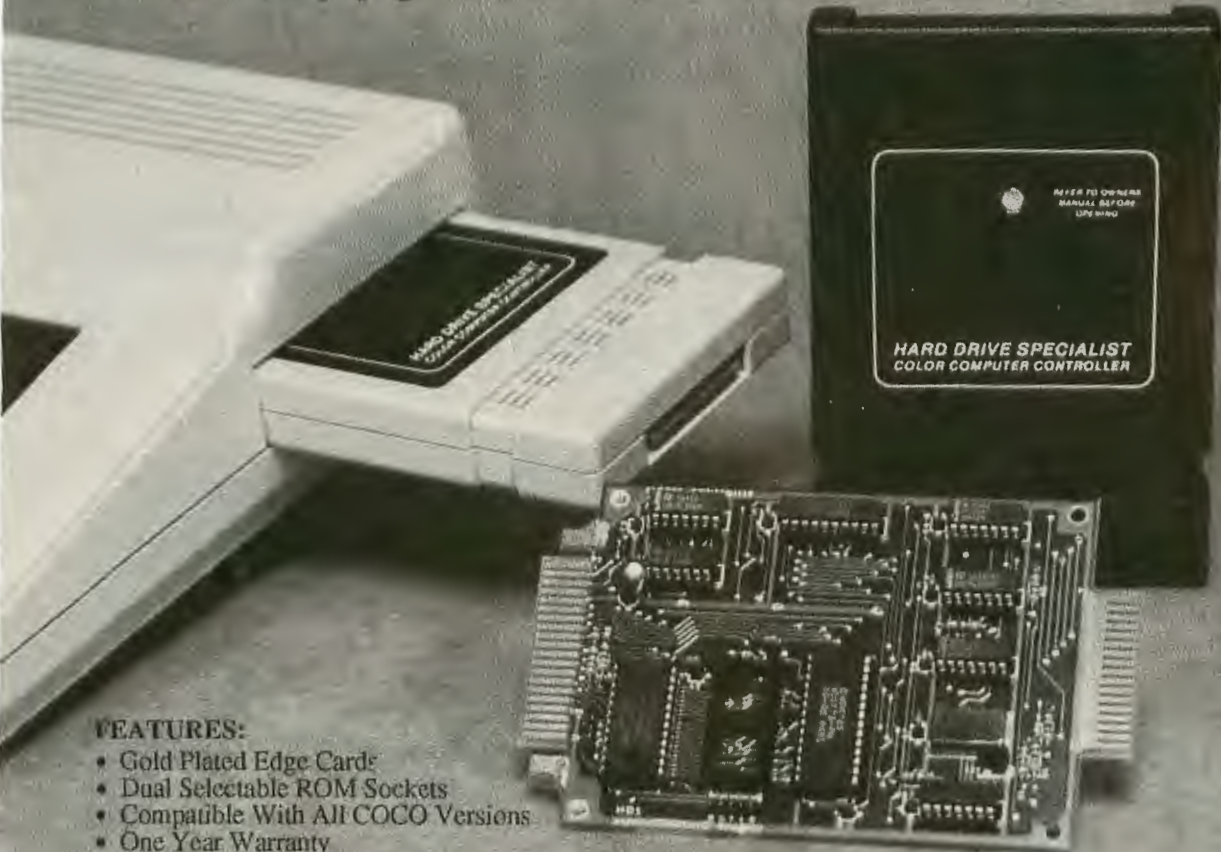

FEATURES:

- Gold Plated Edge Card
- Dual Selectable ROM Sockets
- Compatible With All COCO Versions
- One Year Warranty

HARD DRIVE SPECIALIST has manufactured floppy drive controllers for the Color Computer for SIX years. Buy the controller alone to upgrade your present drive system, or purchase a complete drive 0 to get a high quality drive system loaded with features. This controller allows the use of either two 24 pin ROMs, or one 24 pin and one 28 pin ROM. Using this board with the standard Radio Shack ROM gives you 100% compatibility with all Radio Shack software.

Completed and Tested Board with ROM.....	\$99.
(includes Case and DOS instructions)	
Completed and Tested Board	\$79.
without ROM (includes case)	
Bare Board with Instruction Manual.....	\$30.
Parts Kit for Bare Board without ROM.....	\$30.
Radio Shack ROM (current version).....	\$30.
Double Sided Compatible ROM	\$20.
NEW!	
Magnavox 8CM515 Monitor	\$289.
with Cable for COCO-3	

NEW!

	5.25 inch	3.5 inch
Drive 0 Complete.....	\$169.	\$185.
Drive 1 Complete	\$119.	\$134.
Drive 0&1 Dual Drive Complete	\$259.	\$289.
Bare Drive	\$85.	\$100.

Drive Kits are complete with half height double sided drives mounted in a case with power supply. Drive 0 kits also include cable and controller with ROM. 3.5 inch drives yield 720K when used with appropriate DOS (ADOS, OS9, etc.)

Ordering Information: Use our WATS line to place your order via VISA, MasterCard, or Wire Transfer. Or mail your payment directly to us. Any non-certified funds will be held until proper clearance is made. COD orders are welcome as well as purchase orders from government agencies. Shipping costs are available upon request. If you are not satisfied with your purchase within 30 days, you may return product for full refund excluding shipping costs.



ORDER TODAY!!

HARD DRIVE SPECIALIST

16208 Hickory Knoll ■ Houston, Texas ■ 77059
1-713-480-6000 ■ 1-800-231-6671 EXT 437



*Two utilities to help you download programs
using Radio Shack's Direct Connect Modem Pak*

Working Together: Delphi and Tape I/O

By Don Hutchison

Rainbow CoCo SIG Database Manager

You've got a Radio Shack Direct Connect Modem Pak, and you want to know how to use it to download programs from the CoCo SIG on Delphi? Great! Let's see what's involved.

It's a good idea to be familiar with some of the terminology that we'll be using. Refer to the article "Getting Started with Delphi" in the November '87 issue of THE RAINBOW for a beginner's tour of Delphi. For continuing information about Delphi, Cray Augsburg's monthly column "Delphi Bureau" is virtually required reading.

To sign up with Delphi, locate the directions in the Delphi ad in RAINBOW for finding your local Telenet or Tymnet access number, then call Delphi through one of these services, using your CoCo and your Modem Pak. (Refer to your Modem Pak's manual for instructions on how to connect with these services.) Follow the easy prompts and messages to sign up.

Don Hutchison is an electrical engineer and lives in Atlanta, Georgia. He works as a senior project engineer involved in the design of industrial control systems. On Delphi, Don is the Database Manager of the RAINBOW CoCo SIG. His Delphi username is DONHUTCHISON.

After your Delphi account is approved (this can take less than 24 hours if you have an approved credit card), you're ready to enjoy the goodies in the CoCo SIG's databases. Sign on to Delphi, and then type `GROUPS COCO` to get to the Rainbow CoCo SIG. Your Delphi Guide will give you instructions about how to get to the databases in the CoCo SIG.

The terminal program in the Modem Pak is capable of transferring any standard CoCo file between your CoCo and other CoCos or mainframe computers using the Xmodem protocol. For our purposes, we'll assume you are using a cassette system, although the Modem Pak can also be used with a disk-based system if you use a Multi-Pak. Version 2.0 and higher of OS-9 also have special drivers furnished for use with the Modem Pak.

Since Xmodem is an 8-bit protocol, the Modem Pak's communications parameters must be set up for 8 bits, no parity, and one stop bit before a file transfer is initiated. It is recommended that you use these parameters to call Delphi, since the Modem Pak doesn't automatically adjust to these parameters when it starts an Xmodem transfer. While it is possible to access Delphi at 7 bits and even parity, you'll have to change your communications parameters manually before starting a download.

After you have looked through the database (using the `DIR` and `READ` commands) for programs or files that you may be interested in downloading, it's time to do an actual Xmodem download. Don't let it frighten you, because most of the process is automatic — the hard part is waiting to get the program so you can use it!

Enter the `READ` command to start things moving. Suppose you want to download a game called *Yahtzee*. At the main prompt, `CoCo SIG>`, enter `DATA GAMES`. This will place you in the Games topic of the database. Now type `READ YAHTZEE`. You'll be given a description of the program, and then the screen will display the `ACTION>` prompt and wait for you to tell it what to do. Since you have decided to download the program, just enter `XM` for Xmodem Download. When Delphi has the information ready for you, it will send a message saying, "OK, receive!" At this point, press the `@` and `I` keys together; and the file transfer (download) will start. Delphi will notify you when the transfer is completed, at which point you should save your new download to tape. Didn't

hurt at all, did it? Wasn't it *easy*?

The databases on the CoCo SIG contain many different types of programs: machine language programs, tokenized BASIC programs, graphics files and more. However, the Modem Pak's terminal program was designed for downloading ASCII BASIC programs only, and it doesn't provide for creating any other file type. This makes it impossible for a Modem Pak user to download and successfully use machine language programs without some help from elsewhere. Additionally, many users desire features that simply weren't included in the software for the Modem Pak. What to do?

"When we say a program is 'tokenized' or 'compressed' BASIC, we mean that it's in the same form that would be created if you typed in a BASIC program from the keyboard and then entered `CSAVE 'filename'.`"

No problem! Mike Ward has provided optional support for the Modem Pak when it's used with his popular terminal program, *MikeyTerm*. All that's needed is to run the companion program called *MTPAK*, which will adjust *MikeyTerm* to communicate with the Modem Pak. This step only needs to be done once.

What really happens is that *MikeyTerm* uses the modem portion of the Modem Pak only, bypassing the terminal software. This approach adds many useful and desirable features to a user's system; a CoCo 3 user will be especially pleased, because he will be able to access the 80-column mode of the CoCo 3 with *MikeyTerm*!

MikeyTerm features full buffer control for reviewing what you have read online. A search feature is also provided for quickly locating a selected string in the buffer. A block of the buffer may be marked and then saved to tape or printed. The most common default settings are configurable and are saved for fast startup. (No more setting up everything when you first execute the

program.) *MikeyTerm* can be configured to support a 1 compatible modem should you be one of those. Printer support is provided through the CoCo's standard serial port. Finally, forum or mail messages may be typed into the buffer of *MikeyTerm* and then uploaded when you're online. This will save you connect time charges, since you won't have to type everything while you're online.

MikeyTerm (in ASCII BASIC form) is available for downloading from the CoCo SIG's database using your Modem Pak, or it may be obtained directly from its author for the cost of media and handling. For *MikeyTerm* and full documentation, send \$10 to:

Mike Ward
1807 Cortez
Coral Gables, FL 33134

(Please specify the tape version.) *MikeyTerm* supports all versions of the CoCo, and includes provisions for Xmodem file transfers. If you decide to upgrade to disk operation in the future, *MikeyTerm* also supports disk I/O in the same program.

The Xmodem protocol is in widespread usage these days on virtually all information services and BBSs. In addition, several terminal programs for the CoCo are available that support Xmodem for cassette users. Inherent in the Xmodem protocol is the ability to transfer binary files, and this created a rather severe problem for cassette users who attempted to download machine language programs or compressed (tokenized) BASIC programs created on a disk system. This is due to a simple incompatibility between the tape and disk file formats. Microsoft, the authors of the BASIC used by the CoCo, only provided for the free exchange of ASCII programs between tape and disk systems. The solution is simply a bit of specialized processing in order to get around the problem. Just for background, let's examine each of the file types.

Machine Language Programs

Specifically, machine language files on disk contain embedded control information that is not part of the actual program. This makes such files incompatible with cassette systems unless that control information is removed. Cassette users who have downloaded and tried to execute binary music files have experienced this problem.

A machine language file on disk is

stored as one large block, and looks something like this:

Preamble

Zero Byte
of Bytes to load
Loading address

Data

Program body

Postamble

&HFF Byte
2 Zero Bytes
Execution address

However, a machine language program on tape contains a "namefile" block that precedes the machine language program, and it also contains the loading and execution addresses for the program. (BASIC determines the ending address of the machine language program by counting the number of bytes it loads.) The problem is that terminal programs only load the data blocks following the namefile block, so the receiving terminal program has no way of determining these addresses when it saves the received program to tape. To further compound the problem, the Xmodem protocol was never designed to handle this situation, so the tape user was in need of some specialized help. That help arrived over three years ago in the form of a program called TAPCNV.

TAPCNV is a machine language utility written by Mike Ward that will read a machine language cassette file created on a disk system and remove the disk control information. Once that is done, the file may be saved just like any other machine language file.

To create the machine language program TAPCNV, carefully type in and then run Listing 1. (Be sure to save the program first.) The machine language program will be poked into memory, and some checking is done to try to detect any typing errors. Then the program will ask you for a cassette, and it will save the machine language program for you.

To use the TAPCNV program, just load and execute it. It will prompt you to ready the cassette with the tape containing the binary file that you downloaded and wish to convert. When you strike a key, TAPCNV will read the cassette file and remove the disk control information. The converted file will be moved to its proper place in RAM. When the file has been converted, the start, end and execute addresses are displayed. At

this point you may save the converted program to cassette by entering a command such as `CSAVE "filename", &HStart, &HEnd, &HExec`.

Naturally, machine language programs that utilize disk functions will not work on a cassette system, but programs such as music files will now function as intended.

There are some files that TAPCNV simply can't handle, such as "segmented" files. For purposes of simplicity, consider segmented files to be program segments that must be loaded into different areas of memory. A tape format doesn't exist for segmented files, nor is it possible to create such files from BASIC. Segmented files occur regularly on disk systems, however; Disk BASIC can handle them efficiently.

The BASIC version of the TAPCNV program may also be downloaded from the Utilities topic of the CoCo SIG's database on Delphi, and the assembly language source code for TAPCNV may be found in the Source code topic of the database.

Now, since you have TAPCNV but not *MikeyTerm* (yet), can you use the Modem Pak to download machine language programs from Delphi? Sure! We'll have to modify TAPCNV first, in order to remove some checking that "TAPCNV" does to make sure that it is "fixing" a machine language file.

A simple modification to TAPCNV will disable the checking. Just enter `CLOADM "TAPCNV"`, then enter from the keyboard:

```
POKE &H6DE,&H21 : POKE  
&H6E5,&H21
```

These pokes make TAPCNV ignore the file type of the source program. Normally, TAPCNV requires a binary file and will cease execution if the filetype isn't binary. These pokes modify some of the "error trapping" features of the program, so they are provided on a "use at your own risk" basis.

Tokenized BASIC

When we say a program is "tokenized" or "compressed" BASIC, we mean that it's in the same form that would be created if you typed in a BASIC program from the keyboard and then entered `CSAVE "filename"`. What BASIC will do is replace keywords like `PRINT` or `PAINT` with one character, or "token." Since several characters are replaced with a single character, the term "compressed" BASIC was born. The word "tokenized" is probably more appropriate.

BASIC does this in order to save space and to make program execution faster. Every time BASIC encounters a token, it executes code that already exists in your computer. Whenever you have a BASIC program in your computer, it exists in tokenized format.

The only other way to store a BASIC program is in ASCII format, which you can do by typing `CSAVE "filename",A`. The `A` at the end of that line is what tells your computer to save the program to tape in ASCII (or "text") format. When we say ASCII and/or text, we mean the type of characters you see on the screen when you tell BASIC to list a program.

You might experiment with a few of your programs. Take a BASIC program you've saved to tape, and load it into *MikeyTerm*'s buffer. Then view the buffer — you'll see all sorts of colored blocks and some characters mixed in, too. Then take a BASIC program that's been saved in ASCII format (`CSAVE "filename",A`) and load it into the buffer. When you view the buffer this time, you'll be able to read everything there.

A problem similar to the one involving machine language files causes tokenized BASIC files originating on a disk system to be incompatible with tape systems. BASIC programs saved on disk contain a 3-byte preamble that is not part of the actual program. (Disk BASIC uses this information to determine the size of the BASIC program before loading.) This preamble is not present on BASIC programs on cassette, and it makes such files incompatible with cassette systems unless it is removed. Cassette users who have downloaded and tried to use compressed BASIC files created on a disk system (such as those in the Rainbow topic of the CoCo SIG's database) have repeatedly encountered this problem.

Following Mike Ward's lead, I wrote a utility program to assist tape users with tokenized BASIC programs. `BASFIX` is a utility that will read a tokenized BASIC cassette file originating on a disk system and remove the control information. It will then prompt the user to save the program to cassette.

BASIC programs utilizing disk functions will still not work on a cassette system, but programs such as the `RAINBOW ON TAPE` files in the CoCo SIG's database will now be accessible to tape users. In fact, `BASFIX` was originally written for use with *MikeyTerm* in order to get around the problem of tokenized BASIC programs and cassette users.

BASFIX is compatible with the CoCo 1, 2 and 3. If a CoCo 3 is in use, the screen will default to the 32-column mode automatically, and the processor speed will be adjusted to the normal 0.89-MHz clock rate so that the file may be loaded correctly from tape.

To create the machine language program BASFIX, carefully type in and then run Listing 2. (Be sure to save the program first.) The machine language program will be poked into memory, and some checking is done to try to detect any typing errors. Then the program will ask you for a cassette, and it will save the machine language program for you.

To use the BASFIX program from that point on, simply load and execute it. It will prompt you to ready your cassette player with the tape containing the binary file you downloaded and wish to convert. When you strike a key, BASFIX will read the cassette file and remove the preamble. The converted file will be moved into RAM just as if you had entered PCLEAR 1 and then CLOADed the

program. At this point, you will be prompted to CSAVE the converted program to cassette. From then on, the program may be treated just as any other BASIC program from tape.

Note that BASFIX requires that the cassette file containing the BASIC program has been saved in binary format. This is a technical limitation; it was done to prevent several problems that might occur with an ASCII save of the file, since BASIC actually does a LIST to tape when the ASCII option is used. This procedure could result in extremely long program lines being truncated.

If you are using *MikeyTerm*, simply choose Option 2 (Binary save) from the cassette menu. When prompted for the start and execution addresses, you may simply press ENTER in response to the prompts.

BASFIX is entirely position-independent and may be loaded anywhere in RAM. However, it is strongly recommended that the program be executed at its intended location in order to

provide maximum memory for the converted BASIC program.

The BASFIX utility program (in ASCII BASIC form) may be downloaded from the Utilities topic of the CoCo SIG's database. The assembly language source code for BASFIX may be found in the Source topic of the database. The source code is written for the MACRO 80C assembler and is listed under the name of BASFIX.SRC.

The TAPCNV and the BASFIX programs, their source code files, and their documentation files are copyrighted by their respective authors. However, they may be freely shared with any and all CoCo users and included in club libraries as long as no fee is charged for the program(s). (A small charge for the media and/or xeroxing fee for the documentation is perfectly OK.)

Feel free to contact either me (Delphi username DONHUTCHISON) or Mike Ward (Delphi username MIKEWARD) with any questions you may have concerning these two utilities. See you on Delphi, and enjoy downloading! □

Listing 1: TAPCNV

```

1 CLS
2 IF PEEK(&HC0000)=68 THEN PRINT"
DO NOT RUN THIS ON A DISK SYSTEM
":END
3 PRINT@194,"GENERATING MACHINE
LANGUAGE"
4 FOR X=&H6000 TO &H92C
5 READ H$:POKE X,VAL("&H"+H$)
6 NEXT
7 PRINT:PRINT"PREPARE CASSETTE T
O SAVE TAPCNV"
8 PRINT"PRESS ANY KEY WHEN READY
."
9 IF INKEY$="" THEN 9
10 CSAVEM"TAPCNV",&H6000,&H92C,&H
6000
11 PRINT:PRINT"TAPCNV SAVED!":PR
INT
12 END
13 DATA 7F,FF,40,6F,8D,3,29,6F,8
D,3,24,8E,0,0,AF,8D,3,1F,30,8C,E
B,30,89,FD,FF,AF,8D,3,16,30
14 DATA 8D,4,16,AF,8D,3,10,BD,A9
,28,8E,4,45,9F,88,17,2,B6,54,41,
50,45,20,43,4F,4E,56,45,52,54
15 DATA 20,55,54,49,4C,49,54,59,
0,8E,4,82,9F,88,17,2,99,52,45,41
,44,59,20,54,41,50,45,20,54,4F
16 DATA 20,42,45,20,43,4F,4E,56,
45,52,54,45,44,0,8E,4,C9,9F,88,1
7,2,76,50,52,45,53,53,20,41,4E

```

```

17 DATA 59,20,4B,45,59,20,0,BD,A
1,B1,81,3,26,1,39,BD,A9,28,96,68
,A7,8D,2,9D,86,FF,97,68,C6,1
18 DATA BD,A9,9E,CC,0,F,8E,1,DA,
A7,80,5A,26,FB,30,8D,2,83,17,2,4
8,8E,1,DA,9F,7E,BD,A7,1,DA
19 DATA 7C,26,F9,86,46,B7,4,0,B6
,1,E2,A7,8D,2,6B,86,80,B7,1,E2,8
E,1,DA,17,2,25,A6,8D,2,5C
20 DATA B7,1,E2,BD,A7,E9,B6,1,E2
,81,2,10,26,1,E8,7D,1,E3,10,26,1
,E1,30,8D,2,4B,34,10,BD,A7
21 DATA 7C,35,10,9F,7E,BD,A7,B,1
0,26,1,B0,6D,8D,2,2F,27,E,AC,8D,
2,2F,22,8,AC,8D,2,27,10,22
22 DATA 1,30,D6,7D,6D,8D,2,19,26
,39,63,8D,2,13,6D,8D,2,17,10,26,
1,52,33,8D,2,F,10,AE,43,10
23 DATA AC,8D,2,3,25,9,10,AC,8D,
1,FE,10,25,1,5,10,BF,1,E7,33,45,
34,4,C0,5,1F,21,3A,A6,C0
24 DATA A7,A0,5A,26,F9,35,4,34,1
0,AE,8D,1,DA,3A,AF,8D,1,D5,35,10
,96,7C,81,FF,26,8F,34,10,BD,A7
25 DATA E9,BD,A9,74,35,10,6D,8D,
1,BE,26,52,C6,FF,1F,12,EE,3B,11,
83,FF,0,27,3D,EE,8D,1,AD,33,5F
26 DATA EF,8D,1,A7,31,3F,5A,26,E
9,17,1,54,D,D,55,4E,41,42,4C,45,
20,54,4F,20,44,45,54,45,52,4D
27 DATA 49,4E,45,D,45,58,45,43,2
0,41,44,44,52,45,53,53,0,86,FF,A

```



```

7,8D,1,75,20,9,6D,3D,26,BF,AE
28 DATA 3E,BF,1,E5,A6,8D,1,63,97
,68,6D,8D,1,60,27,1,39,31,8D,0,4
8,F6,1,E7,17,1,22,F6,1,E8
29 DATA 17,1,1C,31,8D,0,52,F6,1,
E5,17,1,12,F6,1,E6,17,1,C,EC,8D,
1,3A,83,0,A,FE,1,E7,33
30 DATA CB,33,5F,1F,30,34,4,1F,8
9,31,8D,0,22,17,0,F1,35,4,17,0,E
C,17,0,D0,D,D,53,54,41,52
31 DATA 54,20,24,20,20,20,20,20,
20,D,45,4E,44,20,20,20,24,20,20,
20,20,D,45,58,45,43,20,20,24,20
32 DATA 20,20,20,D,0,39,17,0,A3,
D,4E,45,58,54,20,42,4C,4F,43,4B,
20,57,49,4C,4C,20,4F,56,45,52
33 DATA 2D,57,52,49,54,45,D,54,4
8,49,53,20,50,52,4F,47,52,41,4D,
D,0,86,FF,A7,8D,0,BD,16,FE,EE

```

```

34 DATA 17,0,6D,D,46,49,4C,45,20
,44,49,44,20,4E,4F,54,20,4F,52,4
9,47,49,4E,41,54,45,D,4F,4E,20
35 DATA 41,20,44,49,53,4B,20,53,
59,53,54,45,4D,D,0,86,FF,A7,8D,0
,87,16,FE,B8,17,0,37,D,54,41
36 DATA 50,45,20,49,2F,4F,20,45,
52,52,4F,52,D,0,86,FF,A7,8D,0,6A
,16,FE,9B,17,0,1A,D,4E,4F,54
37 DATA 20,41,20,4D,2F,4C,20,46,
49,4C,45,D,0,86,FF,A7,8D,0,4D,16
,FE,7E,35,10,A6,80,27,5,BD,A3
38 DATA A,20,F7,6E,84,A6,84,84,7
F,BD,A3,A,6D,80,2A,F5,39,34,10,3
0,8D,0,16,34,4,54,54,54,54,8D
39 DATA 9,35,4,C4,F,8D,3,35,10,3
9,A6,85,A7,A0,39,30,31,32,33,34,
35,36,37,38,39,41,42,43,44,45
40 DATA 46,53,A0

```

Listing 2: BASFIX

```

1 CLEAR 200,&H7FFE:CLS
2 IF PEEK(&HC000)=68 THEN PRINT
"DO NOT RUN THIS ON A DISK SYSTE
M":END
3 PRINT@105,"LOADING basfix":L=1
7:SA=&H600
4 CK=0:L=L+1
5 FOR I=1 TO 32
6 READ H$:IF H$="X" THEN 15
7 PRINT@206,HEX$(SA)
8 X=VAL("&H"+H$):POKE SA,X
9 CK=CK+X:SA=SA+1
10 NEXT I
11 READ I
12 IF I=CK THEN 4
13 PRINT:PRINT"    CHECKSUM ERROR
IN LINE";L
14 STOP
15 PRINT:PRINT"BASFIX IS LOADED.
READY CASSETTEAND PRESS <enter>
... ";
16 LINEINPUT A$:CSAVEM"BASFIX",&
H600,&H98E,&H600
17 PRINT:PRINT "ALL FINISHED!":E
ND
18 DATA 6F,8D,2,88,6F,8D,2,83,BE
,FF,FE,8C,A0,27,27,9,7F,FF,D8,F,
E7,AD,9F,E0,2,17,2,5F,17,2,41,20
,3505
19 DATA 20,20,20,42,41,53,49,43,
20,43,4F,4E,56,45,52,53,49,4F,4E
,20,55,54,49,4C,49,54,59,D,D,D,5
2,45,2042
20 DATA 41,44,59,20,54,41,50,45,
20,54,4F,20,42,45,20,43,4F,4E,56
,45,52,54,45,44,D,41,4E,44,20,50
,52,45,2115

```

```

21 DATA 53,53,20,41,4E,59,20,4B,
45,59,20,0,BD,A1,B1,81,3,26,1,39
,17,2,4,86,53,B7,4,0,96,68,A7,8D
,2477
22 DATA 2,8,86,FF,97,68,17,1,24,
30,8D,2,2,9F,7E,CC,0,F,A7,80,5A,
26,FB,AD,9F,A0,4,AD,9F,A0,6,17,3
102
23 DATA 0,FD,D6,81,DA,7C,26,EF,1
7,1,B5,46,20,0,A6,8D,1,E5,34,2,8
6,80,A7,8D,1,DD,30,8D,1,D1,17,1,
3328
24 DATA AD,35,2,A7,8D,1,D0,17,0,
D5,A6,8D,1,C9,81,2,10,26,1,3C,6D
,8D,1,C0,10,26,1,34,AD,9F,A0,4,2
782
25 DATA 30,8D,1,AB,9F,7E,AD,9F,A
0,6,10,26,1,12,6D,8D,1,99,26,36,
63,8D,1,93,31,8D,1,93,63,A4,6D,A
0,2971
26 DATA 10,26,0,CD,EC,A1,ED,8D,1
,83,C3,C,0,9E,17,30,89,FF,0,34,1
0,10,A3,E1,10,22,1,C,D6,7D,C0,3,
3063
27 DATA 8E,C,1,A6,A0,A7,80,5A,26
,F9,96,7C,81,FF,26,B4,8D,6D,8D,7
6,A6,8D,1,52,97,68,6D,8D,1,4E,27
,1,3552
28 DATA 39,7F,C,0,CC,C,1,DD,19,E
3,8D,1,40,83,0,1,DD,1B,9E,19,EC,
84,27,C,33,4,A6,C0,26,FC,EF,84,3
148
29 DATA AE,84,20,F0,9E,27,9F,23,
9E,19,30,1F,9F,33,9E,1B,9F,1D,9F
,1F,8E,1,A9,9F,B,F,2D,F,2E,F,8,1
7,2653
30 DATA 0,DE,D,D,53,41,56,45,20,

```

50, 52, 4F, 47, 52, 41, 4D, 20, 54, 4F, 20
 , 54, 41, 50, 45, 20, 4E, 4F, 57, D, 0, 39,
 1C, 2018
 31 DATA AF, B6, FF, 21, 84, F7, B7, FF,
 21, 39, 4F, 20, 6, C6, 1, 8D, F, 86, 8, A7,
 E2, B6, FF, 23, 84, F7, AA, E0, B7, FF, 23
 , 39, 4334
 32 DATA CE, FF, 1, 8D, 0, A6, C4, 84, F7
 , 57, 24, 2, 8A, 8, A7, C1, 39, 17, 0, 8C, D
 , 46, 49, 4C, 45, 20, 44, 49, 44, 20, 4E, 4
 F, 2926
 33 DATA 54, 20, 4F, 52, 49, 47, 49, 4E,
 41, 54, 45, 20, 4F, 4E, D, 41, 20, 44, 49,
 53, 4B, 20, 53, 59, 53, 54, 45, 4D, D, 0, 2
 0, 58, 2038
 34 DATA 8D, 5E, D, 49, 2F, 4F, 20, 45, 5
 2, 52, 4F, 52, D, 0, 20, 48, 8D, 4E, D, 4E,
 4F, 54, 20, 41, 20, 42, 49, 4E, 41, 52, 59
 , 20, 2077
 35 DATA 46, 49, 4C, 45, D, 0, 20, 30, 8D
 , 36, D, 4E, 4F, 54, 20, 45, 4E, 4F, 55, 47
 , 48, 20, 4D, 45, 4D, 4F, 52, 59, 2E, 2E, 2
 E, D, 1972
 36 DATA 43, 4F, 4C, 44, 2D, 53, 54, 41,
 52, 54, 20, 26, 20, 54, 52, 59, 20, 41, 47
 , 41, 49, 4E, D, 0, 86, FF, A7, 8C, 2F, 16,
 FE, D0, 2714
 37 DATA 35, 10, A6, 80, 27, 6, AD, 9F, A
 0, 2, 20, F6, 6E, 84, A6, 84, 84, 7F, AD, 9

F, A0, 2, 6D, 80, 2A, F4, 39, C6, 60, 8E, 4
 , 0, 3493
 38 DATA 9F, 88, E7, 80, 8C, 6, 0, 25, F9
 , 39, 0, 0, 0, 0, 0, 0, 0, 0, 0, 0, 0, 0, 0,
 0, 0, 0, 0, 0, 0, 0, 0, 1143
 39 DATA 0, 0, 0, 0, 0, 0, 0, 0, 0, 0, 0, 0,
 0, 0, 0, 0, 0, 0, 0, 0, 0, 0, 0, 0, 0, 0,
 0, 0, 0, 0, 0
 40 DATA 0, 0, 0, 0, 0, 0, 0, 0, 0, 0, 0, 0,
 0, 0, 0, 0, 0, 0, 0, 0, 0, 0, 0, 0, 0, 0,
 0, 0, 0, 0, 0
 41 DATA 0, 0, 0, 0, 0, 0, 0, 0, 0, 0, 0, 0,
 0, 0, 0, 0, 0, 0, 0, 0, 0, 0, 0, 0, 0, 0,
 0, 0, 0, 0, 0
 42 DATA 0, 0, 0, 0, 0, 0, 0, 0, 0, 0, 0, 0,
 0, 0, 0, 0, 0, 0, 0, 0, 0, 0, 0, 0, 0, 0,
 0, 0, 0, 0, 0
 43 DATA 0, 0, 0, 0, 0, 0, 0, 0, 0, 0, 0, 0,
 0, 0, 0, 0, 0, 0, 0, 0, 0, 0, 0, 0, 0, 0,
 0, 0, 0, 0, 0
 44 DATA 0, 0, 0, 0, 0, 0, 0, 0, 0, 0, 0, 0,
 0, 0, 0, 0, 0, 0, 0, 0, 0, 0, 0, 0, 0, 0,
 0, 0, 0, 0, 0
 45 DATA 0, 0, 0, 0, 0, 0, 0, 0, 0, 0, 0, 0,
 0, 0, 0, 0, 0, 0, 0, 0, 0, 0, 0, 0, 0, 0,
 0, 0, 0, 0, 0
 46 DATA 0, 0, 0, 0, 0, 0, 0, 0, 0, 0, 0, 0,
 0, 0, 0, 0
 47 DATA "X"

Hard Disk Mania Sweeps America!

Experts Blame "Incredibly Sane" Low-Cost, High-Performance Interface

This year, 1988, may go down in CoCo history as "The Year of the Hard Disk". Burke & Burke has provided hundreds of low-cost, high performance hard disk interfaces to a very hot Color Computer market in only six months!

Hire a Veteran Today.

The CoCo XT hard disk interface from Burke & Burke lets you connect up to 2 low cost, PC compatible 5-120 Megabyte capacity hard drives to your CoCo. You buy the drive, Western Digital WD1002-WX1 or WD1002-27X (RLL) controller, and a case from the PC dealer of your choice. Just plug them into the CoCo XT, plug the CoCo XT into your Multi-PAK, and you have a 20 Meg OS9 hard disk system for under \$450!

Great for multi-user systems! The CoCo XT interface uses advanced "NO HALT" hard disk controllers, which do not halt your CoCo and do not disable or use interrupts during hard disk access. You get full type-ahead, and the system clock does not lose time during hard disk access. Fully compatible with most RS-232 expansion ports!

CoCo XT (with anodized housing, 60 page user manual, hard disk back-up utility and new, Version 2.1 drivers for use with both OS9 & HYPER-I/O) -- \$69.95. Or choose the **CoCo XT-RTC** (Includes real-time clock / calendar with battery backup) -- \$99.95

THE PROFESSIONAL TOUCH: XT-ROM - Automatically boots and reboots OS9 from hard disk. Installs in your hard disk controller's BIOS ROM socket - \$19.95.

Now: Hard Disk for BASIC

"Dynamic Disk Interface" runs hard drives, big floppies, and more!

You or someone that you know may have the 35 Track Blues. It strikes hundreds of CoCo users every year. One day you wake up, and say to yourself, "These 35 track floppy disks are just too small."

There's only one cure. More storage. Get it. With HYPER-I/O, from Burke & Burke.

BASIC for the '90's

HYPER-I/O modifies the RS-DOS Disk BASIC in your CoCo 1, 2, or 3 to provide a "Dynamic Disk Interface". Use your existing BASIC and RS-DOS software with hard disk interfaces (CoCo XT, DISTO), RAM Disks, and any mix of floppy drives from 180K to 720K each. Fully RESET protected, user configurable, expandable, OS9 compatible, EPROM-able HYPER-I/O may soon be THE system of choice for the CoCo 1, CoCo 2, and CoCo 3. HYPER-I/O Version 2.5 now available for only \$29.95.

HYPER-III (RAM Disk and Print Spooler for CoCo 3 HYPER-I/O) -- \$19.95

"Instant Guru" Department

Tools to let you spend less time fighting OS9, and more time using it.

Wild & MV Version 2.0 Use "wildcards" with most OS9 commands, or rearrange your directory tree. Features recursive directory searches. A hard disk must! \$19.95

EZGen Version 1.02 Powerful OS9 bootfile editor. Change module names, add or delete modules, patch bytes, or rearrange modules. Works on other files, too. \$19.95

Daggorpatch If you own Dyna Micro's Dungeons of Daggorath™ cartridge, this program will convert it to run from disk! Adds disk load and save, quit, screen print, repeat last command, pause, and more. HYPER-I/O and RS-DOS compatible. \$12.95

R. S. B.

We broke out the champagne. It was revolutionary! Who ever thought you could run BASIC, in an OS9 window?

Everyone knows that BASIC and OS9 are incompatible. The commands are completely different. The floppy disks are completely different. BASIC programs won't run under OS9.

Future Shock

Some people say that they "hate" OS9. Many people who buy OS9 don't use it, because it's unlike anything they've ever seen before. Well, like it or not, Level 2 OS9 is the future of the CoCo. Even the newest games use OS9 now.

Burke & Burke has developed a new program, RSB, to help you take that first step towards falling in love with Level 2 OS9.

BASIC Clone?

The first time you run RSB, it copies your RS-DOS ROMs to an OS9 disk file. Our proprietary installation software converts this disk file to an OS9 "shell" that can be run like any other OS9 program. You can even program the CoCo to automatically use RSB as your "shell" whenever you start up OS9.

RSB won't run machine language programs, but you can use all of the familiar Super Extended BASIC™ commands and program statements. You can even take advantage of OS9's built-in "windows" to run several BASIC programs at once! And RSB runs at the full 2 MHz speed of the CoCo -- always.

If you have a Speech Sound PAK™, or a Super Voice™, RSB upgrades will allow you to use these devices to execute commands like PLAY and SOUND "NO HALT".

Break out the champagne. Break out the OS9. Break out **RSB**. \$39.95



Burke & Burke

P.O. Box 1283 Palatine, IL 60078-1283 (312) 397-2898



ILLINOIS RESIDENTS PLEASE ADD 7% SALES TAX. COD's add \$2.20. Shipping (within the USA) \$2.00 per CoCo XT, \$1.50 per disk or ROM. Please allow 2 weeks for delivery (overnight delivery also available for in-stock items). Telephone orders accepted (312) 397-2898.



In this and in future "CoCo Consultations," I will be trying something new. In addition to the familiar Q & A column, I will also include tidbits of information contributed by various folks and, in some cases, comment on the information. Thus, even if you don't have a question, I invite you to send in any little hints or descriptions of experiences you have had with the CoCo that you think might be of interest to the CoCo-owning public in general.

'Sparklie' Solutions

I've been following your discussion of the problem of "sparklies" on the screen when using a Color Computer 3 under OS-9. What can you say to summarize what you know of the problem and its cure?

*Daivd Barns
(GLENSIDE)
Glenside, IL*

It is true that some CoCo 3s show tiny flashes on the screen, especially under OS-9 and during disk I/O. The "sparklie" problem varies considerably from machine to machine. Some do not seem to have it; others are seriously plagued by it — to the point that the sparklies occur even during Disk BASIC. Sometimes the problem develops after installation of a given brand of 512K upgrade. The sparklie problem appears to be a very subtle timing problem in dynamic RAM addressing. It also appears to vary with the particular issue of GIME chip in the machine, the particular make and model of DRAM chip used for the 512K upgrade, and the heat of the machine. Sometimes the sparklie problem appears only after 20

Martin H. Goodman, M.D., a physician trained in anesthesiology, is a longtime electronics tinkerer and outspoken commentator — sort of the Howard Cosell of the CoCo world. On Delphi, Marty is the SIGop of RAINBOW's CoCo SIG and database manager of OS-9 Online. His non-computer passions include running, mountaineering and outdoor photography. Marty lives in San Pablo, California.



By Marty Goodman Rainbow Contributing Editor

minutes or more, when the machine has warmed up.

There are primarily two routes to try to fix the problem. Both involve significant expense and/or hardware effort. First, several folks have reported that the sparklie problem is cured by replacing the 68B09 chip in the CoCo 3 with its CMOS cousin, the Hitachi 6309 chip. Unfortunately, this option is limited to skilled hardware hackers. The 68B09 is soldered into the CoCo 3, so you must carefully desolder that 40-pin chip, install a socket, and then obtain and insert the 6309 chip. Such desoldering is rather delicate, and you run the risk of damaging traces to the 68B09 on both sides of the PC board.

The second fix is to replace your GIME chip with a newer model. The older GIME chips are marked copyright 1986. The newer ones are marked copyright 1987. Also, the new GIME chip is named TCC 1014A, whereas the old one is named TCC 1014. Replacing the GIME chip is a delicate process unless you have very specialized tools. It is easy to damage the contacts on the GIME chip or on the socket, or to damage the socket itself. Attempt this replacement only if you know what you are doing, and proceed with great care. Tandy is currently asking \$50 for a new GIME chip, which I think is unreasonably high.

Customized Layout for the CoCo

I am considering putting a CoCo system in an IBM PC-type case. I am contemplating building an expansion board and manually switching +5 volts to each of the various ROMs that might be in cartridges. What do you think of this plan?

*F.G. Swygert
APO Armed Forces*

Don't try it! A Multi-Pak interface is essential for proper operation of a multislot system, for reasons entirely unrelated to slot selection. First of all, if you put more than half an inch of 40 conductor ribbon cable on the CoCo system bus, your machine will either not run at all or be unreliable.

In addition to slot selection, the Multi-Pak provides TTL buffers on all address and data lines. Those buffers are needed, for the naked output lines of the 6809 cannot be fanned out unamplified to three or four extra cards without causing the machine to either crash or operate very unreliably. Your plan to fan out the bus of the CoCo without using buffers would not work.

Finally, an IBM PC-type box is a relatively poor choice for repackaging a custom CoCo because it is the wrong shape. In order to shoehorn an extensive CoCo system into such a box, you'd have to use significant lengths of ribbon cable on the 40 conductor system bus. That, as I noted above, is unacceptable. Frankly, having done such a repackaging job several times myself, I really urge you to abandon the idea entirely. It is *not* in my opinion worth the effort.

The same effect can be achieved far more easily by merely mounting a CoCo and Multi-Pak off to the side of, above, or below your work area, and then putting the keyboard at the end of an extender cable and into a case for placement on your work area or (for the sake of your back) on your lap. I make such a cable for use by tinkerers and do-it-yourselfers; it is sold by Microcom Software. It also has provisions for a remote reset and power-on light. For about twice the price, HJL sells what appears to be an excellent package that includes a plug-in keyboard cable, an extremely well-designed remote keyboard case, and one of its excellent CoCo replacement keyboards. I'd recommend my system to those who want

to save a little by making their own keyboard case, and HJL's to those who prefer to buy something that plugs right in and can be immediately used.

In any case, whether you buy my cable, HJL's system, or make up your own extension keyboard cable, leave the CoCo + Multi-Pak + plugged-in cards setup alone, and put it out of the way via an extension keyboard. In my opinion, this is by far the best approach to customizing your CoCo's physical layout for more convenient operation.

FD 502-Related OS-9 Crashes

See pg 184
The FD 502 series drive is wired up in a peculiar way, rather differently from any of the preceding drive units from Tandy for the CoCo. With all other drive systems from Tandy, when you accessed any one drive, all the drive motors were turned on. With the FD 502 system, if you have two drives, when you access any one of them the other drive motor is not turned on. In this respect, the FD 502 works like the drives on an IBM PC. But this causes serious problems with OS-9 in operations where a user is copying from one drive to another. OS-9's driver software does not wait for the second drive to come up to speed because it "thinks" that the drive's motor was already turned on at the time the first drive was accessed. The result is occasional crashed disks due to the drive starting to write before the head has come up to speed. I understand Tandy may release patches for the OS-9 disk drivers to correct this problem. The patches would contain code that pauses for a fraction of a second each time a new drive is selected to wait for the motor on that drive to come up to speed.

Kevin Darling
(KDARLING)
Raleigh, NC

Thanks for alerting us to this potential problem, Kevin. Note that knowledgeable hardware hackers should be able to carefully check out the wiring of the motor-on and drive select lines in the FD 502 and redo the wiring so that all motors in the system do go on when any one drive is accessed. Though I have not looked much inside the FD 502, I would imagine the problem is that, as delivered, the motor-on line and the drive select line are tied to the same pin, or linked logically so that the motor-on signal will only be seen as valid if the drive in question is also selected. A bit

of hacking should be able to cure this, if the hackers know what they are doing.

Note, also, that the FD 502 will also have similar problems with Disk Extended BASIC: Programs that do two-drive operation, particularly disk backup operation, will result in occasional crashed sectors on an unmodified FD 502 drive system, for the same reasons there are problems with it under OS-9. These problems will be disastrous, but sufficiently infrequent as to be maddening to someone looking for the cause.

It is also interesting to me that this very subtle problem is extremely similar to an equally subtle problem that I christened the "head settle bug," which plagues owners of drives that have head solenoids. Many years ago I described this bug and a patch to the Disk BASIC ROM for it in the magazine *HOT CoCo* — one of the first CoCo articles I ever wrote. I now recommend that any owners of older head solenoid drives disable that function by merely selecting the HM options, which keeps the head down all the time.

From ROM Pack to Disk

How can I put the ROM packs Thexder and Shanghai on disk? I am tired of plugging and unplugging my disk controller whenever I want to play the games, and all the available slots in my Multi-Pak are used up with OS-9-related hardware.

Dennis McMillian
Pittsburg, CA

First, you need to know how to transfer the "raw file" from the ROM pack to tape. This is accomplished by first putting a tiny piece of tape *only* over Trace 8 on the ROM pack. Trace 8 will be the first pin you encounter on the underside of the ROM pack, near (but on the *opposite* surface of the edge connector) that one slightly shortened trace. Note that traces 2, 4 and 6 are missing on these ROM packs, so Trace 8 is the first one you encounter. Cover this and *only* this trace with a bit of frosted "magic tape."

Now, with the power off, plug in the ROM pack and then turn the power on. The pack will now *not* autoexecute because of the covered trace, so you will be greeted by the ordinary Extended BASIC sign-on message. Now type POKE &HFFDE,0 and press ENTER. Connect your cassette tape recorder and save contents of the the ROM pack to disk using the command CSAVEM "file-

name", &HC000, &HFEFF, &HA027. The *filename* can be THEXDER or SHANGHAI, whichever one you are working on.

Now turn the power off, remove the ROM pack, and replace it with the disk controller. Power up again.

For *Shanghai*, load the tape into your Disk BASIC system using the command CLOADM "SHANGHAI", &H7000 and press ENTER (assuming you named the cassette file as SHANGHAI, of course). This command will offset-load the data into lower RAM memory. Now modify the data by entering this:

```
POKE &H303C, &H7E
POKE &H303D, &H30
POKE &H303E, &H5E
```

Now save the data to disk as follows:

```
SAVEM "SHANGHAI", &H3000,
&HGEFF, &H3000
```

You'll now have a disk file of *Shanghai* that you can load and execute.

For *Thexder*, load the tape using the command CLOADM "THEXDER", &H6000 (assuming you named the cassette file as THEXDER when you saved it to cassette). Modify the data by entering the following:

```
POKE &H20BF, &H20
POKE &H20C0, &H0F
POKE &H2102, &HDF
POKE &H2104, &H20
POKE &H4BB5, &H50
POKE &H4BE3, &HAF
```

Now save the modified data to disk with the command SAVEM "THEXDER", &H2000, &HSEFF, &H2000.

Your technical questions are welcomed. Please address them to CoCo Consultations, THE RAINBOW, P.O. Box 385, Prospect, KY 40059.

We reserve the right to publish only questions of general interest and to edit for brevity and clarity. Due to the large volume of mail we receive, we are unable to answer letters individually.

Questions can also be sent to Marty through the Delphi CoCo SIG. From the CoCo SIG > prompt, pick Rainbow Magazine Services, then, at the RAINBOW > prompt, type ASK (for Ask the Experts) to arrive at the EXPERTS > prompt, where you can select the "CoCo Consultations" online form which has complete instructions.

Calligrapher Combo Special - Save \$14.95

Order either the OS9 or RSDOS CoCo Calligrapher Combo, which includes the Calligrapher and the two Economy Font Packages, and you will receive the small Font Set #7 free! A total of 59 fonts for only \$69.95! This special offer is available through September 30, 1988.

CALLIGRAPHER

CoCo Calligrapher - (Hybrid BASIC/ML) Turn your CoCo and dot-matrix printer into a calligrapher's quill. Make beautiful invitations, flyers, certificates, labels and more. Includes 3 fonts: *Gay Nineties*, *Old English* and *Cartoon*. The letters are 1/4 inch high and variably spaced. Works with many printers including Epson, Gemini, Radio Shack, Okidata 92A, Banana and Pro-writer. Additional fonts are available (see below). Tape/Disk; \$24.95.

OS9 Calligrapher - (C) Although a different program from the CoCo Calligrapher, the OS9 Calligrapher prints all the same fonts. It reads a standard text file which contains text and formatting directives. You may specify the font to use, change fonts at any time, centering, left, right or full justification, line fill, margin, line width, page size, page break and indentation. Similar to *troff* on UNIX systems. Includes *Gay Nineties*, *Old English* and *Cartoon* fonts. Additional fonts are available (see below). Disk only; OS9 Level I or II; \$24.95.

Calligrapher Fonts - Requires Calligrapher above. Each set on tape or disk; specify RSDOS or OS9 version; \$14.95 each. **Set #1** - (9 fonts) Reduced, reversed and reduced-reversed versions of *Gay Nineties*, *Old English* and *Cartoon*; **Set #2** - (8 fonts) *Old Style* and *Broadway*; **Set #3** - (8 fonts) *Antique* and *Business*; **Set #4** - (8 fonts) *Wild West* and *Checkers*; **Set #5** - (10 fonts) *Stars*, *Hebrew* and *Victorian*; **Set #6** - (8 fonts) *Block* and *Computer*; **Set #7** - (5 small fonts) *Roman*, *Italics*, *Cubes*, *Digital* and *Old World*.

Economy Font Packages on disk; specify RSDOS or OS9; \$29.95: **Font Package #1** - Above font sets 1, 2 and 3 (25 fonts) on one disk. **Font Package #2** - Above font sets 4, 5 and 6 (26 fonts) on one disk. Both Packages #1 and #2 (51 fonts) on one disk; \$49.95.

Calligrapher Combo Package - Includes the Calligrapher and both Economy Font Packages, 54 fonts in all; specify RSDOS or OS9; \$69.95. See special offer above.

Sample Calligrapher fonts

The CoCo Calligrapher!

INFORMATION MGT.

TIMS (The Information Management System) - (Hybrid BASIC/ML) Tape or disk, fast and simple general data base program. Create files of records that can be quickly sorted, searched, deleted and updated. Powerful printer formatting. Up to 8 user fields, sort on up to 3 fields. Tape/Disk; \$19.95.

TIMS Mail - (Hybrid BASIC/ML) Tape or Disk based mailing list management program. Files are compatible with TIMS. Fast and simple to use. Supports labels 1, 2 or 3 across, 2 1/2 to 4 inches wide. Tape/Disk; \$19.95.

TIMS Utility - (Hybrid BASIC/ML) Utility companion for TIMS and TIMS Mail for multi-term search (AND and OR logic), global change and delete, split large files and more! Tape/Disk; \$14.95.

TIMS Combo Package - All three of the above programs: TIMS, TIMS Mail and TIMS Utility on one disk - \$34.95.

UTILITIES

OS9 Patcher - (C) Display and modify the contents of a file or memory module. Search for value or string. Calculates module CRCs; Disk only; OS9 Level I or II; \$19.95.

Color Disk Manager - (100% ML) Disk utility with these features: Disk repair, selective track initialization, verify sectors, backups, tape to disk transfer, ROM Pak execution from disk, much more! Tape/Disk; CoCo 1, 2, 3 (except for 64K mode); \$24.95.

EDUCATIONAL

Trig Attack - (100% ML) Ages 9 and up. In this educational arcade game, enemy *trigs* travel along math curves. Players learn important mathematical concepts as they play. Sound effects, colorful graphics. Excellent manual includes an introduction to trigonometry. Tape 16K CB/Disk 32K ECB; CoCo 1, 2, 3; \$19.95.

The Educational Combo - The Combo includes these educational (and entertaining) games: **Silly Syntax** (ages 5 and up) story creation game with 2 stories

Galactic Hangman (ages 7 and up) animated graphics, with a 700 word vocabulary

The Presidents of the USA (ages 10 and up) a presidential trivia game

The Great USA (ages 9 and up) a trivia game of the states

Trig Attack (ages 9 and up) Zap those *Trigs*

All five programs on one disk; \$49.95.

SPECIAL INTEREST

Rental Property Income and Expense Management Package - Maintain your rental property income and expense records. Print output supported. 28 expense categories. This program may be tax deductible. Disk only; \$29.95.

CoCo Knitter - Easy to use program to display or print instructions to knit a sweater: Cardigan or Pullover; Round or V-neck; Raglan or Set-in Sleeve; 3 weights or yarn; 8 sizes from baby to man. Tape/Disk; \$19.95.

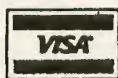

SUGAR SOFTWARE

P.O. Box 7446

Hollywood, Florida 33081

(305) 981-1241

All programs run on the CoCo 1, 2 and 3, 32K Extended Basic, unless otherwise noted. Add \$1.50 per tape or disk for shipping and handling. Florida residents add 6% sales tax. COD orders add \$5. Dealer inquiries invited. Orders generally shipped in 24-48 hours. No refunds or exchanges without prior authorization.

I am looking for techniques or programs that allow BASIC programs to be transferred from CoCo to IBM. I realize that most programs will have to be edited, but that is better than keying them in. Would saving the BASIC programs as ASCII files on the CoCo, then making the transfer by a null modem cable or the phone lines work?

David Johnstone
Torrington, CT

R As you suggested, saving the programs in ASCII is the first step. Making the transfer with a null modem and a communications program on each would work (e.g., *Mikeyterm* on the CoCo, *ProComm* on the IBM). The commercial program *CoCoUtil* allows the IBM to read, write and format Color Disk BASIC files. Marty Goodman published programs to transfer files between IBM and CoCo disks in "The Great Transformation" in the June 1986 *RAINBOW* and "Transfer CoCo Files To MS-DOS Disks" in the July 1987 issue. Using D.P. Johnson's *SDisk3*, you can add Clearbrook Software's MS-DOS driver to OS-9 Level II. Using files from the OS-9 SIG on DELPHI — GREGL's AR and IPATCH.AR, and BRUCEISTED's PCDDOS.AR, RSDOS.AR and CC3DISK.AR — you can enable OS-9 Level II to read and write disks in the IBM-PC and Disk Color BASIC formats.

A Bug in BASIC?

Happily pecking away at my computer the other day, I decided to enter a program from *THE RAINBOW*. After typing it in, I tried to run it. The computer gave me an "FC Error in Line 15." That line contained PMODE 4, 1. I tried every combination of PMODE I could think of, always with the same results: "FC Error." I closed the computer and then reopened it; after that it accepted PMODE quite happily. What happened? I have a CoCo 3 and BASIC

Richard Esposito is the principal engineer for BDM Corporation. He holds bachelor's, master's and doctorate degrees from Polytechnic Institute of Brooklyn. He has been writing about microcomputers since 1980.

Richard Libra is a simulator test operator for Singer Link Simulation Systems Division.



By Richard E. Esposito
Rainbow Contributing Editor
with Richard W. Libra

2.1, and I never had that problem before. Should I bundle up my CoCo and head to Radio Shack? Is it a bug in BASIC?

Christiane Tom
Quebec, Canada

R On power-up the CoCo 3 copies all its ROMs into RAM — including BASIC. If you load and run a BASIC program that contains pokes and typographical errors, BASIC can be altered so that it malfunctions. Even after you fix your BASIC program, the CoCo's BASIC interpreter may still contain poked bugs that will remain in effect until you power down and reboot the machine. Since the problem has not recurred, this seems like a logical explanation.

Changing Characters

In the March '88 issue of *THE RAINBOW*, Bill Barden had an article locating the CoCo 3's HPRINT character table in memory and telling how characters can be changed to your taste. Where is the table for the regular text screen characters, and can they be changed also?

Tim Fultz
Bonneau, SC

R The "regular" text characters were in the SAM chip on the earlier

CoCos and are in the GIME chip on the CoCo 3. In both cases, they are not in RAM and therefore cannot be altered with software.

Paint and Printer Don't Mix

I have Tandy's DeskMate 3 Version 1.00 and am unable to print a picture I drew on the screen using DeskMate's Paint feature. All I get is garbage. The other features of DeskMate print out without any problems and with no modifications to the program or printer. I have a 128K CoCo 3, Multi-Pak Interface (modified by Radio Shack), Tandy CM-8 color monitor, Tandy FD 501 disk drive and a Star NX-10 dot matrix printer.

George Masek
Maryville, TN

R With the exception of *DeskMate* 3's Paint feature, the other features perform only ASCII text printing, which is pretty much a standard across all printer lines. The Paint feature, on the other hand, was written by Tandy to use the 7-dot graphics drivers built into its own LP and later DMP printer lines. The Star printer you have uses IBM's 8-dot graphics and is incompatible with Tandy's graphics driver.

Memory Locations and Dual Speed

The 128K CoCo 3 has memory locations &H70000 to &H7FFFF. Why, then, is it possible to access memory locations below &H70000? For instance, with the high speed poke I discovered another location by poking values into locations &H400 through &H5FF, which caused characters to appear on the Lo-Res text screen, although the Lo-Res text screen memory location is &H70400 through &H705FF.

Also, when OS-9 Level II is initialized on the CoCo 3, at what speed is the CoCo 3 running, 0.894 or 1.788 MHz? How do you switch speeds in OS-9 Level II? Radio Shack's catalog says OS-9 Level II supports dual speed on the CoCo 3, so both speeds should be available.

Bruce Arsenault
Nova Scotia, Canada

R On the CoCos 1 and 2, the address space was 64K ranging from \$0000 to \$FFFF. Direct access to mem-

ory addresses was accomplished in BASIC with peeks and pokes. To maintain compatibility with programs written for earlier machines, peeks and pokes on the CoCo 3 access the 64K addresses \$70000 to \$7FFFF "normally accessible" to BASIC by using CoCo 3 extended addressing terminology. If you prefer using extended addresses, the CoCo 3 has the additional functions LPEEK and LPOKE. To give an example, POKE&H0500 is the same thing as LPOKE&H70500.

OS-9 Level II normally operates at 1.788 MHz. You can switch speeds by writing to the GIME registers at \$FFFD8 (slow) and \$FFFD9 (fast).

Logon Problems

 I am having problems logging on to Delphi — or any other BBS system, for that matter. I am working with a CoCo 2 64K ECB disk and tape. I recently ordered Autoterm 3.2T, which is no help either. I have the Deluxe RS-232 Program Pak, and I'm using the TRS-80 Modem IB (Part Number 1175). My problem is that every time I connect, everything from the host computer comes back to my screen so garbled I can't understand it. I recently had a new telephone line put in my den just for computer communications, and I got the "no-frills" service: no call waiting, rotary line service, etc. Could that be the problem? Would logging on work better with digital service?

Cardell Stevenson
Philadelphia, PA

R_x Unless the quality on rotary dial lines in Philadelphia is much worse than elsewhere, I don't think that's the problem; I use rotary dial lines at 2400 baud with no problem. Your problems are more likely the wrong baud rate, type of parity or number of stop bits set with your communication software or hardware.

Colorless CoCo 3?

 Now that I have a CoCo 3 with an RGB monitor, many of the programs I keyed in from THE RAINBOW on my old CoCo 2 with a color TV screen no longer give a color display, appearing instead in black and white. A friend told me that this is because the RGB monitor does not show the artifact colors you get with the color TV. Is this the case, and is there any kind of a routine I can key in on the CoCo 3 that will let me run these old programs and get the colors

I got with the CoCo 2 and the color TV?

Also, I would like to try out the BBS program I keyed in from the November 1987 issue of THE RAINBOW, making the CoCo 3 the answering terminal and the CoCo 2 the originating terminal so that I can observe the operation of the BBS program on both screens. Do I just connect the serial port of one CoCo to the serial port of the other, (i.e., disconnect the modem)? The March 1987 "CoCo Consultations" column gave some rather cryptic instructions for making a null modem cable. It is my understanding that you need two 4-pin DIN connectors and a length of 3-wire cable. Pin 3 of Plug 1 is then connected to Pin 3 of Plug 2; Pin 2 of Plug 1 is connected to Pin 4 of Plug 2; and Pin 4 of Plug 1 is connected to Pin 2 of Plug 2. Can you please confirm that this is the correct procedure?

Please note that I do not have a Radio Shack RGB monitor. I have a Magnavox Model 8CM515, which can be used in RGB or composite mode. I've been using it in RGB mode.

Charles Roman
Skokie, IL

R_x With your Magnavox 8CM515 you also need to make the composite video connection, using a cable with phono jacks at both ends. Then when you want to view artifacting colors, push the CVBS button under the flip panel on the front of your monitor.

Your description of the null modem cable is fine.

An Address and an 80-track Drive

 Do you know the address for Mikeyterm so I can get it on OS-9? Also, what kinds of 80-track 5¼-inch drives are available?

Allen Martin
Holbrook, MA

R_x Mikeyterm author Mike Ward's address is 1807 Cortez, Coral Gables, FL 33134. Incidentally, Mikeyterm runs only under Disk BASIC. It is not designed to work with OS-9.

The only 80-track drive I would consider is the TEAC 55F. The older ones have a jumper marked DS that can be set for 40- or 80-track operation. I prefer to replace the DS jumper with a DPST switch, giving me hardware selection of 40- or 80-track operation. The newer TEAC can be similarly configured by adding a resistor (10 ohm) in line with an SPST switch to the

solder pads marked "R15." I recently found out there is yet a newer version of these drives with two large square ICs. (The older drives had only one.) The newer drives require a 100 ohm resistor with a switch connected to the solder pads marked "R19."

Replacement Generator

 I've been told that the 6847-TI VDG mentioned in your January 1988 column has been discontinued. Is this true? If not, where can I purchase one, and how much can I expect to pay? If it is true, can another type be substituted?

T. Anthony Ertl
Colbert, WA

R_x Although it is no longer manufactured or readily available, I believe you can still order one as a replacement part for a Korean CoCo 2. The price is approximately \$15 from Radio Shack National Parts.

Shifted Display

 I am using my new Magnavox 8CM515 monitor with Greg-E-Term to write this letter. I am using a CoCo 3 in 80-column mode; for some reason my display is shifted all the way to the left so that the characters on the extreme left are barely legible, yet there is almost three-quarters of an inch available on the right. Why is that? Is there an adjustment I can make to correct this situation?

Dennis Wood
Indianapolis, IN

R_x Adjust the "horizontal centering" at the left rear of your monitor.

For a quicker response, your questions may also be submitted through RAINBOW's CoCo SIG on Delphi. From the CoCo SIG> prompt, pick Rainbow Magazine Services, then, at the RAINBOW> prompt, type ASK for "Ask the Experts" to arrive at the EXPERTS> prompt, where you can select the "Doctor ASCII" online form which has complete instructions.

Communication is important in today's world. We understand what other people are saying because we all know the rules of communication. This set of rules is a sort of English protocol. When we hear the word "apple" (perhaps a bad example!) we immediately think of a red, ball-like object that can be eaten. If you say the word to anyone who knows the English protocol, he or she too will think of a red, ball-like object that can be eaten. This is a form of communication.

A set of rules has to be followed in communicating with a computer, too. This time you cannot use the English protocol, because the computer does not understand that — yet! To communicate with most computers, you have to press a number of switches arranged in a way that is familiar in human communications: the keyboard. We press these switches in an order that makes sense to us, but to the computer this is just a sequence of pressed switches. It compares this sequence to a known sequence in its memory banks. If a match is found, the computer then proceeds according to its programming.

The keyboard is an interface between a person and a computer, but there are times when we want one computer to communicate with another computer in order to transfer some kind of information the user needs or is sending. This computer-to-computer communication also has to follow a certain protocol.

There are many of these, ranging from simple serial communications to high-speed networks to parallel main-frame workstations. The protocol most used in the CoCo is serial. In this case, serial means to transfer data one bit at a time. The CoCo's internal memory is organized in eight-bit chunks called bytes. To transfer one byte of data from one computer to the other serially requires eight bit transfers. But that is just the data. In order to keep errors at a minimum, a start bit and a parity bit must also be included.

The CoCo has no special hardware to communicate in a serial fashion. Instead, it has a few bits on a PIA that is used by the CPU to simulate a real serial

Tony DiStefano is a well-known early specialist in computer hardware projects. He lives in Laval Ovest, Quebec. Tony's username on Delphi is DISTO.

Communicating computer-to-computer

All About Serial Packs

By Tony DiStefano
Rainbow Contributing Editor

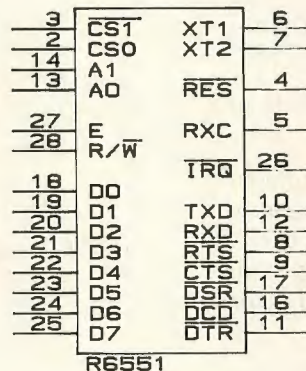

Figure 1

port. This makeshift port is limited in speed and performance. Also, with the exception of the CoCo 3, there doesn't seem to be any good software that supports this "bit banger," especially if you want to communicate at 1200 baud. The CPU simply does not have enough time to take care of the serial I/O and still do the rest of its chores. This led Tandy to introduce the Deluxe RS-232 Pak.

Inside it lies the hardware for a real serial port and true RS-232 protocol. At its heart is the Rockwell R6551 ACIA

(Asynchronous Communication Interface Adapter) chip. This chip has all the necessary circuitry to interface the parallel data of the CoCo's CPU to the standard RS-232 serial protocol and is capable of baud rates of 50 to 19,200. (Baud rate is the speed at which the bits are transferred.) It is also capable of word lengths from five to nine and has a programmable number of stop bits and parity detection. In fact, it is a great chip for our use. Figure 1 shows the pin-out of the R6551; a pin-by-pin description of this 28-pin chip appears in Figure 3 on the next page.

RS1	RS0	WRITE	READ
0	0	Xmit Data Register	Rmit Data Register
0	1	Reset	Status Register
1	0	Command Register	
1	1	Control Register	

Figure 2

From Figure 2, we see that the R6551 has four registers. The first is the data register. This is data going to and from the different computers. The next register is the Control Register. Bits 0 through 3 control the baud rate of the ACIA. Here is a list of the baud rates:

Bits	Baud Rate Generated
3 2 1 0	EXTERNAL
0 0 0 0	50
0 0 0 1	75
0 0 1 0	109.92
0 0 1 1	134.58
0 1 0 0	150
0 1 0 1	300
0 1 1 0	600
0 1 1 1	1200
1 0 0 0	1800
1 0 0 1	2400
1 0 1 0	3600
1 0 1 1	4800
1 1 0 0	9600
1 1 0 1	19200

Bit 4 controls the external clock, with 1 being baud rate and 0 being external. Bits 5 and 6 are word length. 00 is 8, 01

is 7, 10 is 6 and 11 is 5. Bit 7 high is two stop bits, and Bit 7 low is one stop bit. The next register, the command reg-

ister, is used to control the specific transmit and receive functions shown in Figure 4.

Pin No.	Name	Description	Pin No.	Name	Description
1	GND	Signal and power ground. All signals are referenced to this pin.	12	RXD	Receive data input pin used to transfer data from the external device.
2	CS0	Active low-input chip selects the device. When this pin is low and CS1 is high, the chip is selected.	13	RS0	First of two register select lines connected to CPU address lines. Used to select various internal registers. See Figure 2.
3	CS1	Active high-input chip selects the device.	14	RS1	Second of two register select lines. See Figure 2.
4	RES	Active low input resets and initializes internal registers to zero.	15	Vcc	Input is connected to +5 volts. It powers the chip's internal circuits.
5	RSC	Receive clock pin is bi-directional; serves as the receiver of 16X clock input or output.	16	DCD	Data carrier detect input pin used to indicate to the chip the status of carrier detect output of the external device.
6	Xtall	This pin and Xtal2 are normally directly connected to an external crystal to derive various baud rates. Crystal frequency for these baud rates must be 1.8432 MHz.	17	DSR	Data set ready input pin used to indicate readiness state of the external device. A low indicates a "ready."
7	Xtal2	Connected to other side of the crystal.	18-25		Data bits D0 through D7, respectively; bi-directional lines used to transfer data to and from the CPU to the chip.
8	RTS	Request to send output used to control the modem from the processor. Output of this pin is determined by contents of the command register.	26	IRQ	Interrupt request pin is an open collector (drain) output used to flag the CPU when the chip has finished using data. IRQ status bit allows many pins to be connected to the same IRQ line to the CPU.
9	CTS	Clear to send input pin used to control transmitter operation. Transmitter section of the chip is automatically disabled if CTS is high.	27	E	E clock input to this pin used to gate all data transfers to and from the CPU.
10	TXD	Transmit data output pin used to transfer serial data to the external device. The least significant bit is transmitted first, with rate determined by baud rate selected.	28	R/W	Read/write input pin used to control direction of data transfers between the CPU and the chip. A low on the R/W pin allows a write to the chip.
11	DTR	Data terminal ready output pin used to indicate status of the chip. A low on DTR indicates the chip is enabled. This bit is controlled via Bit 0 in the command register.			

Figure 3

Bits	Description
0	Hi= Enabled DTR Lo= Disabled DTR
1	Hi= IRQ Disabled Lo= IRQ Enabled
3 2	Xmit IRQ RTS Other
--	
0 0	Disabled Hi -
0 1	Enabled Lo -
1 0	Disabled Lo -
1 1	Disabled Lo Xmit BRK
4	Hi= Echo Lo= Normal
7 6 5	Operation

X X 0	Parity Disabled
0 0 1	Odd Parity
0 1 1	Even Parity
1 0 1	Mark Parity Xmit Check Disabled.
1 1 1	Space Parity Xmit Check Disabled.

Figure 4

The final register is the status register. These bits in the status register indicate to the processor the status of the various

Bit	Low	Hi
0	No parity error	Parity error detected
1	No framing error	Framing error detected
2	No Overrun error	Overrun error detected
3	Receive buffer -Not full	Receive buffer -full
4	Transmit buffer -Not empty	Transmit buffer -empty
5	DCD detect	DCD not detected
6	DSR ready	DSR not ready
7	No IRQ	IRQ has occurred

Figure 5

R6551 functions as outlined in Figure 5.

The R6551 is the heart of the pack, but not the only part. Its job is to take the eight-bit data to and from the CPU and transmit it at the right baud rate and parity, but that is not all. This chip has a high level of 5 volts and a low level of ground, or 0, volts. RS-232 standards require that the voltage for serial communications be a high of +12 volts and a low of -12 volts. This is done through two chips known as level shifters. The first, the MC1488, is a shifter that changes 5/0 volt levels to 12/-12 volt levels. The other, the MC1489, does the opposite: It shifts the 12/-12 volt inputs to 5/0 volt.

Other parts include decoders and buffers, resistors and capacitors. Software in a ROM is also included. This software gives the CoCo the ability to communicate with other computers. It is OK as far as "dumb terminals" go, but it lacks the power for good data transfers. Most people use other third-party software to drive this pack.

I have designed an equivalent to the above-described RS-232. It functions the same except that it has no built-in software — no great loss, since most people do not use it. If you are using OS-9, the software driver is already included and is compatible with my pack. For prices and delivery, call CRC at (514) 383-5293.

Hint . . .

Cobble the Step Rate

You can use the *Cobbler* command to tailor what you get in memory when the system disk boots. For instance, if you want a faster step rate as a permanent feature, first make sure that both *Modpatch* and *Cobbler* are on your disk in the commands directory. Then use the *Edit* or *Build* command to create this short program called *Steprate*, which is to be stored in the root directory:

```
L d0
c 14 00 02
V
```

(See Dale Puckett's column in the May '87 issue of *THE RAINBOW*, Page 201, for various step rate values.)

Play it safe and make a backup copy of the whole disk once you have the step rate file in place. (Caution: A fragmented boot file cannot be cobbled, yet it might not reveal itself until you start the *Cobbler* action. This destroys the disk contents.) Use the backup copy to cobble things into memory. At the OS-9 prompt, call the step rate action by entering *modpatch steprate*. Then with the faster rate in place (you will hear your disk action change), cobble the change into permanency at the OS-9 prompt by entering *cobbler /d0*. You can now delete the step rate file, and know that next time you boot OS-9 it will come online with the change in place.

Del Turner
Kamloops, BC

THE POWER STONES OF ARD

THE QUEST FOR THE SPIRIT STONE



You're tired, you're hungry, not to mention you're badly injured. No one in town seems to want to talk to you. Your magic sword has stopped glowing, the room is dark, you're out of spells, you can't get your wand to work, you won't swear to it but you may be lost, you have no idea what that last puzzle meant, and you hear something large moving just beyond the only door. The old sage warned you there would be days like this!

"QUEST FOR THE SPIRIT STONE" is an Adventure that will keep you playing for hours. It features single keystroke commands, 16 color graphics, 100% Hi-Res graphics screens, full game save, extensive playing area, level advancement, and the disk is not copy-protected. You choose your character's name, race, sex, and ability scores. The use of arrow keys simplify movement. This one is easy to play but a challenge to complete!

ONLY \$18.00 AND WE PAY SHIPPING!

North Carolina residents add 5% sales tax

COLOR COMPUTER 3 AND ONE DISK DRIVE REQUIRED

Send check or money order to:
or call:
(919) 582-5121

THREE C'S
PROJECTS
P.O. Box 1323
Hamlet, NC 28345



Barden's Buffer

Can You Survive This Column?

By William Barden, Jr.
Rainbow Contributing Editor

What three terms thrust most fear and loathing into the hearts of CoCo aficionados? No, the answer is *not* "MS-DOS, IBM and OS-9!" I was thinking more along the lines of assembly language, interrupts and BASIC "internals."

If you can bear with me through this column, I'll reveal some of the secrets of these topics. In addition, I'll show you an elegant program that I haven't seen before (although it's undoubtedly been done by someone). As you might guess, the program gets into all three areas. As Nietzsche (or was it G. Gordon Liddy?) might have said, those CoCo topics that don't confound you make you stronger. This column will certainly test your mettle!

The Program

What I have in mind was prompted by a column I read in *Communications of the ACM*. The shining light in this professional magazine is written by Jon Bentley and called "Programming Pearls" — an interesting look at programming problems and topics. Bentley, reminiscent of Martin Gardner and his "Mathematical Games" column in the old *Scientific American*, has the ability to make things simple. In one of his columns Bentley mentions a program that times the component parts of a program so that the user can see how efficient his code is. Although a simple example is given, it got me to thinking: It should be possible to *display* an entire program graphically, with the speed of various parts indicated on the graph. A sample is shown in Figure 1.

How can this be done? One way might be to incorporate a timing routine in each subroutine of the program. The subroutine might be called at entry and exit to record the elapsed time from the CoCo `TIMER` function. This is kind of messy, though, and doesn't allow you to get any finer resolution than a subroutine, which may consist of many lines.

Bill Barden has written 27 books and over 100 magazine articles on various computer topics. His 20 years' experience in the industry covers a wide background: programming, systems analysis and managing projects for computers ranging from mainframes to micros.

A better idea would be to time each BASIC statement or line. A BASIC statement takes a certain amount of time to execute, of course — on the order of milliseconds (thousandths of a second). The following program takes about 2.5 seconds to execute on a CoCo 3 in slow speed, making each of the 1,000 times through the loop about 2.5 milliseconds.

```
100 FOR I = 1 TO 1000
110 NEXT I
```

How this time is divided between Line 100 and Line 110, though, is anyone's guess. Longer lines and those involving mixed number calculations, division and exponentiation may be dozens of times slower.

One way to time the execution of a BASIC line would be

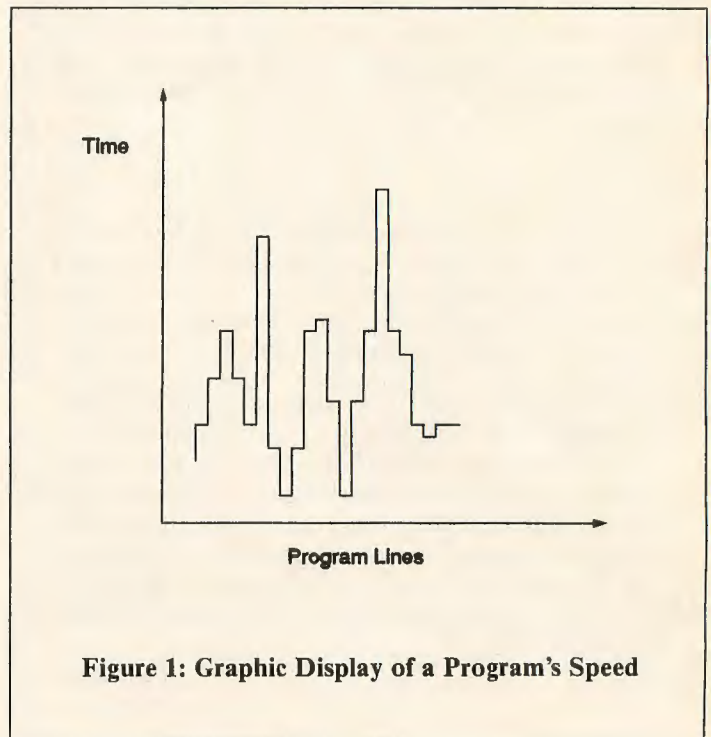

Figure 1: Graphic Display of a Program's Speed

to record the time at the beginning and end of the line. To do that, though, we'd need some hooks in the "internals" of the BASIC interpreter. Another approach is to periodically sample the execution of a program. If the program could be tested every few milliseconds, we could examine which line was executing and tally a mark for that line, as shown in Figure 2. At the end of the program execution, we'd have a tally of the times that each line had executed. Some lines might be missed, but in the long run we'd have a pretty good idea of which program lines took the longest.

It probably won't surprise you to learn that there is a way to perform this sampling. The CoCo has a real-time clock interrupt that occurs 60 times per second. One-sixtieth of a second is about 16.7 milliseconds, which is not fine enough to catch all lines, but over many iterations of a program should represent the relative elapsed times of each line.

What's an (Oops, There's the Doorbell!) Interrupt?

An interrupt is a temporary suspense of the program's operation in order to perform some other important task. The important task is another program, but usually a short one. Once this task is performed, the interrupted task is picked up once again from the interruption point. Interrupts can be catastrophic or non-catastrophic.

Older computers with non-volatile core memory, which retained data even after power was turned off, had a "power fail" interrupt. In the space of a few milliseconds before the power disappeared completely, the status of the machine would be saved in core memory. When power was again restored, the program picked up again from the interrupted point. You could literally yank the power cord, wait a minute and plug it in again — the computer would continue typing a listing as if there had been no interruption!

A non-catastrophic interrupt is one that is more or less expected. Pressing a key on the keyboard generates an interrupt for some computers. If the computer is displaying data on the screen, the display might be interrupted for a few milliseconds while the keyboard character is read into a buffer. The user probably isn't even aware that the interrupt has occurred.

There are a number of different interrupts in the CoCo. The 60-Hertz (60 times per second) interrupt, though, is

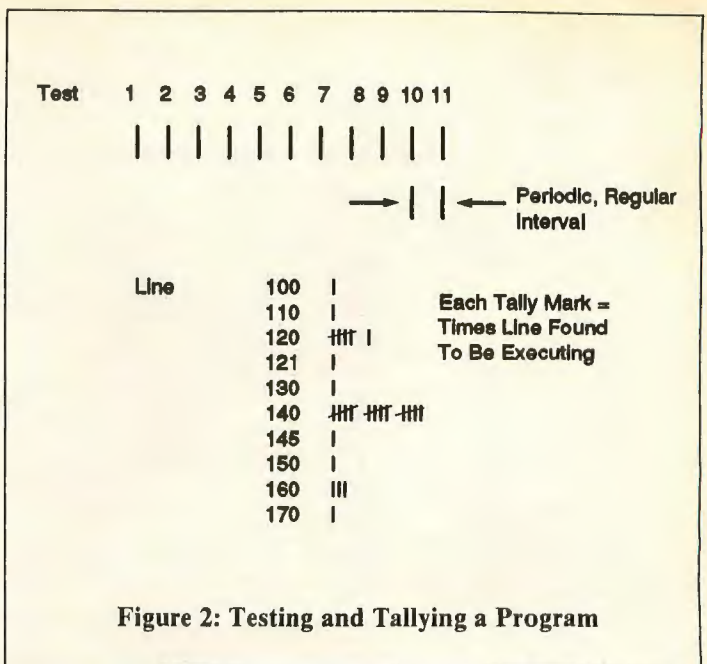

Figure 2: Testing and Tallying a Program

handled through the IRQ interrupt, which is usually the main interrupt in a microprocessor such as the 6809.

The IRQ interrupt is used mainly to increment a counter for the TIMER function. If you look up the TIMER function in the BASIC manual, you'll see that it returns a count of the elapsed time in one-sixtieth-second increments.

When an IRQ occurs, the 6809 microprocessor automatically transfers control to an interrupt subroutine in BASIC ROM. This interrupt subroutine contains a few dozen machine language instructions to increment the counter for the TIMER.

If we could sneak in a few lines of our own code, we could examine BASIC to see which line was executing, make a tally, and then let BASIC continue with the TIMER update function. Sounds easy enough. . . .

Which Line is Executing?

However, that's another problem. How do we know which line is being executed?

Introducing the FOCUS™ software system for OS-9™ Level II—serious business for your CoCo3!

FOCUS Applications Hub

A multi-tasking/multi user systems of I/O functions and utilities which features:

- Two level menu system with company code and access code protection.
- Unique filing, sorting, searching and record locking routines.
- Works with most printers, floppy/hard drives and terminals.
- Similar keys and screen formats for all FOCUS-MATE programs.
- Routines for file maintenance, data backup and setup.
- Context-sensitive help screens.

FOCUS-MATE Correspondence Module

An integrated Text Editor, Text Formatter and Mailing List Database:

- Import text or database files for mail merge facilities.
- Control all printer functions, change formats anywhere in text, save formats.
- Preview final text on screen.
- Print with left, right, full or centered justification, tabs, auto headers/footers, page numbering and dictionary lookup.
- Multiple text column capability.

FOCUS-MATE General Ledger Module

A sophisticated General Ledger package for small business.

- All features integrate with other FOCUS-MATE modules.
- Number of accounts and transactions limited only by disk space.
- Auto balance checking, flexible period and year-end procedures, profit/cost center consolidated ledger and batching capabilities.
- Reports: Balance Sheet, Trial Balance, P&L Statement, Transaction Journal, Transaction Aging.

OS-9 Programmers: FOCUS is a great tool-box for system developers!

with purchase of OS-9 Level II and FOCUS, boot file is free, multi-task on 128K! OS-9 Level II \$64.95

	Reg.	Now
FOCUS	\$65.95	\$55.95
Correspondence Module	49.95	39.95
General Ledger Module	49.95	39.95
FOCUS Technical Manual	19.95	15.95

Min. Sys. Req.: CoCo3, OS-9 Level II, 360K disk drive, 80 col. display

Upgrading your CoCo System? Ask us about Peripherals!

Special: Bare 1/2ht. Floppy Drives, 360K \$89.95, 720K (31/2") \$119.95.

Easy Street™
Data Systems

4500 19th St. #530
Boulder, CO 80302
(303) 440-4767

Add \$3.00 for shipping/handling
TERMS: COD, Money Order, Cashiers checks, Allow 2 weeks for personal check to clear. Sorry no MCVISA
Hours: 10:00 to 6:00 MST, Tues.-Sat.

OS-9 is a trademark of Microware and Motorola Inc.

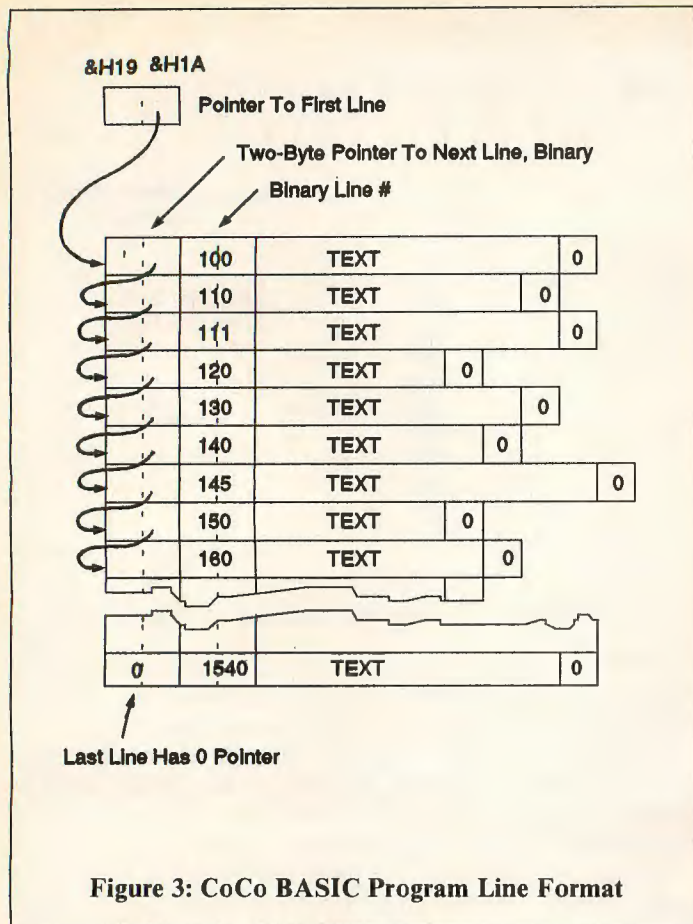

Figure 3: CoCo BASIC Program Line Format

Think about a BASIC interpreter. Obviously it has to record the current number of the line being executed, in addition to other things such as the current position of the BASIC statement in the line, the link to the next line, and so forth.

How do you go about finding out how BASIC operates? The best way is to get a disassembly of BASIC. CoCo BASIC is written in assembly language, a low-level language that the 6809 microprocessor understands. Microsoft, as secretive as the next billion-dollar company, doesn't freely distribute copies of the assembly language code for any system's BASIC. However, various people have disassembled the Microsoft code and published disassemblies with comments. By looking at these listings, you can see what is going on in BASIC. I've even been known to disassemble parts of BASIC myself, using the disassembly capability of *EDTASM+*, the CoCo editor/assembler/debugger. (However, I haven't published any disassemblies, so please don't ask me for one — I use the superlative Spectral Associates publications.)

In looking at the BASIC disassembly, it's easy to see that the start of the BASIC program is stored in locations &H19 and &H1A — the &H prefix indicates a hexadecimal constant. Addresses in the CoCo are stored in two bytes, with the first byte being the most significant and the second, the least. Together they make up a 16-bit number representing a memory address of 0 through 65535. (CoCo 3's extended memory still uses this scheme for the 64K memory space of BASIC.)

BASIC program lines have the rigid format shown in Figure 3. They are stored contiguously in memory, one following the other. They may be from six to 254 bytes long, depending upon what's in them. The first two bytes of each line, however, are the memory address, in binary, of the next BASIC

program line. The next two bytes are the memory address, also in binary, of the line number. The text of the line follows, with the end of the line marked with a zero byte. BASIC text is "tokenized" — converted to one- or two-byte codes instead of ASCII characters — for efficiency in storage. The last line of the BASIC program has a zero value for the memory pointer.

The program shown in Listing 1 starts at the beginning of the BASIC program and follows the lines through to the end. The line number is displayed for each line, and the program stops when the last line is reached. As you can see, there's nothing too magical about this process. The two bytes of the memory pointer and line number are converted to a 16-bit unsigned integer (values from 0 through 65535) by multiplying the first byte by 256 and adding the second byte, as shown in Figure 4.

Recording the Lines

If we're to examine the program 60 times per second and tally which line is being executed, we'll need a table of line numbers and a place to put the count. Each 60 counts represents one second's worth of time. Since we might be waiting several seconds in some lines (for example, *INPUT* lines that are waiting on user input data), we'll need at least two bytes to hold a count value. One byte for a count value can hold only 255 counts, but two bytes can hold 65,535 counts, representing 1,092 seconds.

We want to hold these counts in memory, since writing to disk would be too slow. But where in memory? One option is to reserve an area of memory using the *CLEAR* statement. The *CLEAR* statement in the CoCo reserves a stack area (for BASIC's internal calls) and a protected memory area. The format of *CLEAR* is *100 CLEAR B00, &H6FAE*.

Here every location from &H6FAF onward has been protected from use by BASIC — it's like setting aside a reserved area to do anything we want with. CoCo BASIC RAM memory extends from &H0000 (decimal 0) to &H7FFF (32,767 decimal). We also set aside 800 bytes above for the stack; this is just an arbitrary figure. In case you're wondering about the odd figure, &H6FAE, it'll be explained shortly.

&H7000 is a nice round figure at which to start a table. The table must hold every line number and a 16-bit count. Since line numbers are also 16 bits, we'll need four bytes for each entry, as shown in Figure 5. The area from &H7000 to &H7FFF is 4,096 bytes long, large enough to hold $4,096/4 = 1,024$ entries. We'll actually hold 640 entries, however, due to

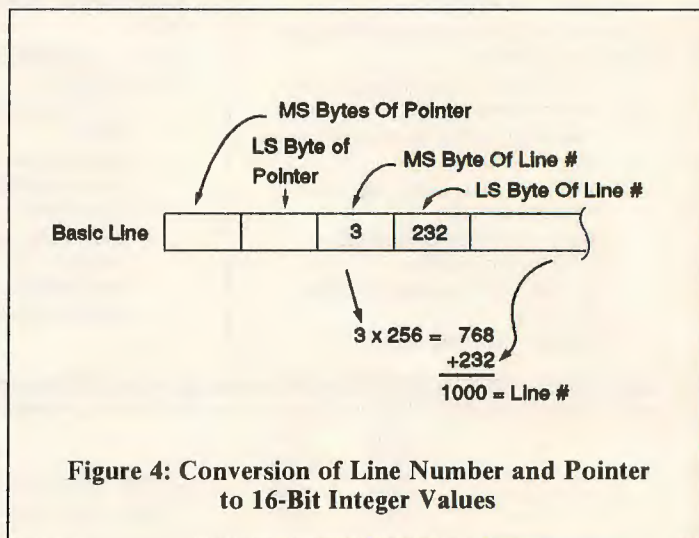

Figure 4: Conversion of Line Number and Pointer to 16-Bit Integer Values

display limitations. Still, 640 BASIC lines is a long program.

The program shown in Listing 2 scans the BASIC program in memory and lists all line numbers less than 10000. For each line number, an entry is made in the table at &H7000: two bytes of the line number and two bytes of the count, which is initialized to zero (there's garbage in the count if it is not cleared). The last line number of the table is marked as Line Number 0, a nonexistent line number.

The BASIC program to do this starts with Line Number 10000. We don't want to record the execution times of this program, but rather the execution time of another program to be tested; for this reason the *Time Analyzer* lines are ignored.

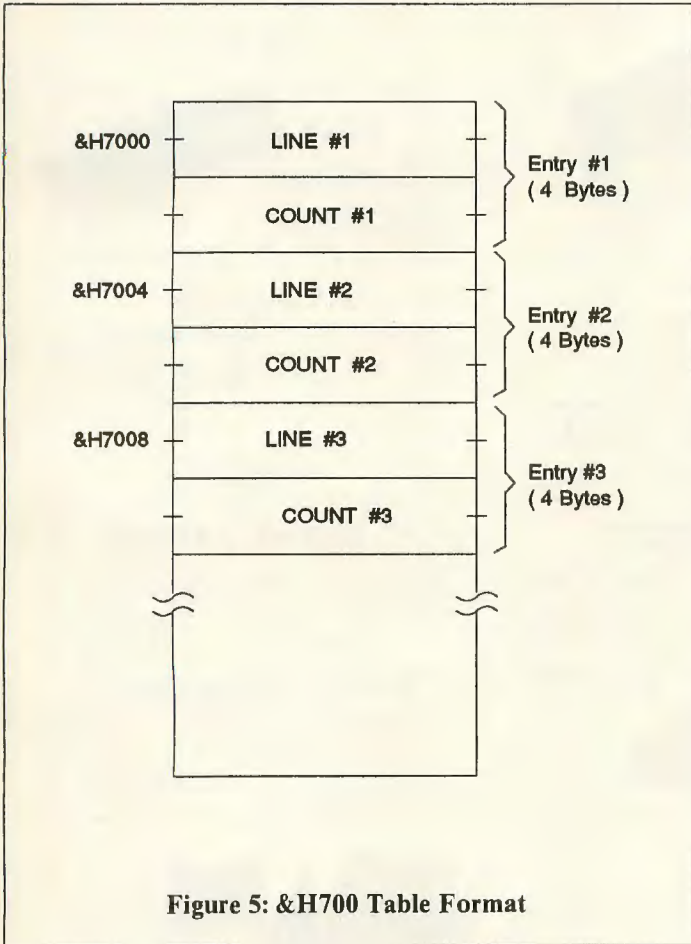

Figure 5: &H700 Table Format

The Program Display

Let's move ahead a little bit and see what kind of display we need. Assume that we have initialized the table, and the counts have been magically made during execution of the program we're testing. The next step is display the data in some coherent form. One way is shown in Figure 6.

Figure 6 uses the 640-by-192 mode of the CoCo 3 to display line numbers. Since there may be hundreds of them, they are displayed by position. Each dot position represents another line number; and the display goes from left to right, equivalent to BASIC program lines from beginning to end. The number of counts (one-sixtieth second) is displayed as a vertical line. The higher the line, the more times an interrupt occurred while that line was being executed and the more time that line takes.

However, we also want to be able to read out the actual count for each line. We've accomplished that by moving a "line cursor" along the X axis. As the line cursor is moved,

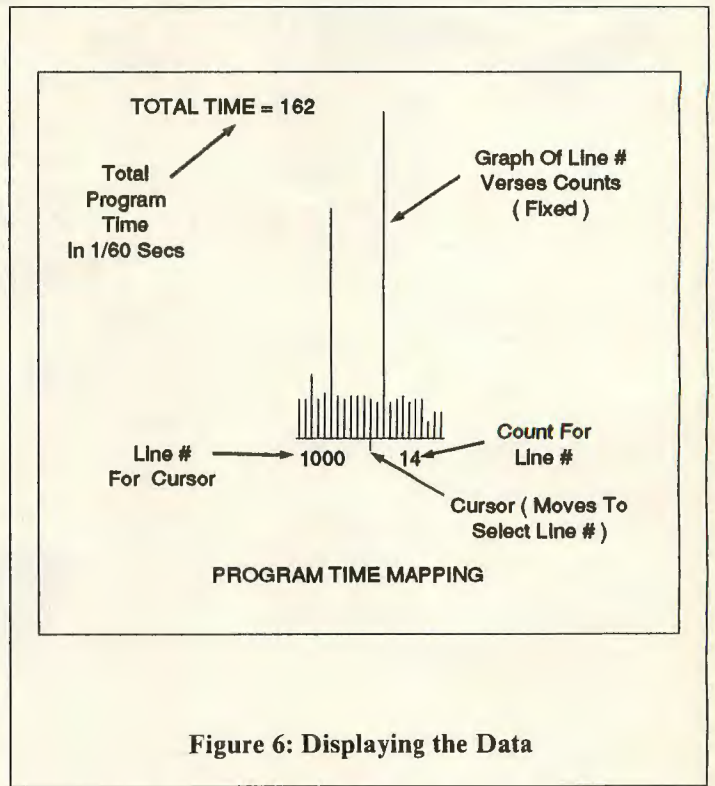

Figure 6: Displaying the Data

DMC "No Halt" Disk Controller

\$137.50*

*without ROM

Unleash your CoCo's potential!

Our new Dual Mode Controller (DMC) implements a new "no halt" mode of operation so it can read from or write to disk all by itself. The 6809 is freed to process other tasks and respond to interrupts. This is how OS-9 was meant to run! But the Radio Shack "halt" mode of operation is also retained to maintain full compatibility with existing non-OS-9 software.

New! OF-Link (FLEX under OS-9)

Lets you run FLEX in a window under OS-9 Level II. Ask for more details. Introductory price \$49

Other DMC features:

- works with original CoCo, CoCo2, or CoCo3 (Multi-Pak usually required)
- no adjustments — all digital data separator and write precompensation
- gold plated card-edge connectors for reliability
- ROM socket takes 24 pin or 28 pin chip; dual DOS capability
- Radio Shack DOS 1.1 ROM for complete compatibility
- 8K bytes cache memory on board (32K optional)
- D.P. Johnson's SDISK package (specially modified for DMC) is included at no charge (\$30 value)
- disk caching software included free
- fully assembled and tested; 120 day limited warranty
- call or write for free brochure for more details

To order: DMC controller with RSDOS 1.1 and SDISK (specify OS-9 Level I or II) \$149.50 plus \$5 S/H (\$12 overseas). Add \$16 for 32K RAM option. Terms (prices in \$US); check, money order, VISA. U.S.A. orders shipped via UPS from WA state.

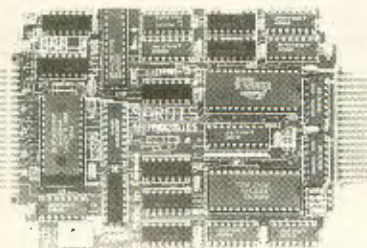

Did you know?

...that all the older floppy disk controllers for the CoCo completely tie up (and even halt) the 6809 processor during disk reads and writes? No wonder your keyboard is constantly "losing" characters! Or that your serial port often gives you garbage.

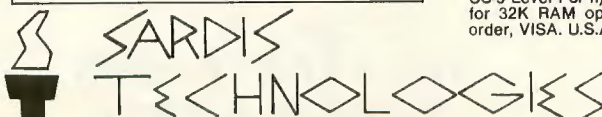

2261 East 11th Ave., Vancouver, B.C., Canada V5N 1Z7

(Also ask about our ST-2900 6809 based expandable single board computer)

(604) 255-4485 (Pacific Time)

NEW

TANDY ADD-ONS

For Tandy 1000, SX, TX

10 Meg Hard Card

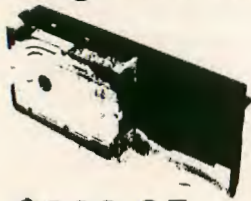

\$299.95

1000, SX, TX

20 Meg Hard Card

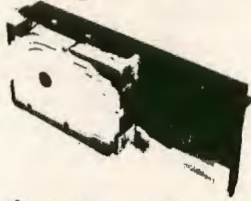

\$349.95

1000, SX, TX

30 Meg Hard Card



\$399.95

1000, SX, TX

Hard Drive Kits



10 Meg	\$279.95
20 Meg	\$339.95
30 Meg	\$379.95
40 Meg	\$499.95

NEW TANDY

1000, SX, TX
49 Meg Hard Card
32 MS (speed)

\$599.95

Rodime

NEW Cardinal Modems

2400 Baud 300/1200/2400

(Hayes Compatible)

Complete with software manuals

ONLY **\$149.95**

1000, SX, TX

Cards

300/1200 Modem	\$119.95
300/1200/2400 Modem	\$149.95
Mini IO	\$79.95
2 Meg Board	\$169.95

TANDY 1000

1000, SX, TX, 3000, 4000

2nd Floppy

360K	TEAC	\$119.95
720K	Mitsubishi	\$99.95
3 1/2"	Mitsubishi	\$119.95



1000, 1000A

Memory Cards

Zucker Memory

• DMA & 512K **CALL**

Zucker Multifunction

- Serial
- Real Time Clock
- 512K DMA
- Software

CALL

Tandy 3000 & 3000HL

Hard Drive Kits

Includes Drive, Controller & Cable

20 Meg	\$399.95
30 Meg	\$599.95
40 Meg	\$699.95
80 Meg	\$999.95

Tandy Model 3, 4, 4P

Hard Drive Systems

External

Complete - ready to run

10 Meg	\$499.95
20 Meg	\$699.95

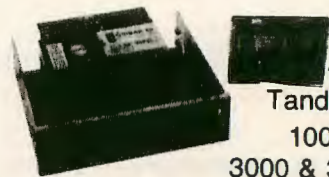

Tandy 1000,
1000SX,
3000 & 3000HL

Tape Backup

20, 30, 40 Meg Tape Backup	\$399.95
60 Meg Tape Backup Archive	\$659.95

TRUE DATA PRODUCTS

115 So Main Street
Uxbridge, MA 01569

Tel. 617-278-6555

1-800-635-0300

Hours: 9 a.m.-6 p.m., Sat. 10 a.m.-4 p.m.

NEW DISK DRIVES

Starting at

89⁹⁵

with case &
Power Supply
129.95

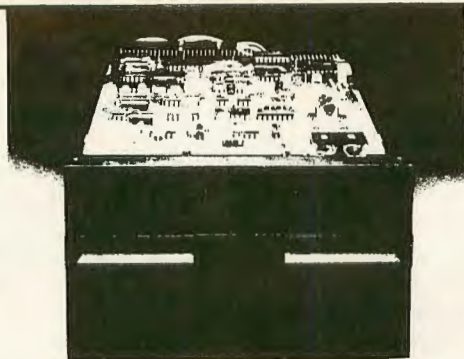

TANDON MPI TEAC

Speed 6ms tk to tk and up
Capacity 250k unformatted
Tracks 40
Warranty *now 1 Year*

New Low Price!

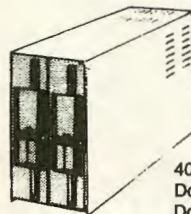

40 Tks 6Ms
Double Sided
Double Density

40 or 80 Tracks
1/2 Hght. Teac/Panasonic



SATISFACTION GUARANTEED!!

ALL DRIVES FULLY TESTED AND WARRANTED

We carry only the finest quality disk drives
no seconds • no surplus

Free Software for Drive 0 Systems

CoCo Checker...Test roms, rams, disk drives and & controller printer, keyboard cassette & more.
Tape/Disk Utility...Transfers disk to tape and tape to disk.

169⁹⁵ Drive 0

- Full Ht Drive
- Single Case
- Heavy Duty Power Supply
- 2 Drive Cable
- Gold plated contacts
- Controller & manuals

189⁹⁵ Drive 0

- Double Sided Slim Line Drive
- Case holds 2 slim line drives
- Heavy Duty Power Supply
- 2 Drive Cable
- Gold plated contacts
- Controller & Manuals

289⁹⁵ Drive 0 & 1

- 2 Double Sided Slim Line Drive
- Case holds 2 slim line drives
- Heavy Duty Power Supply
- 2 Drive Cable
- Gold plated contacts
- Controller & Manuals

Other Drive Specials

Drives cleaned, aligned & tested, **29⁹⁵**

119⁹⁵

2nd Drive
for new Radio Shack
includes:

- Slim Line DS/DD Drive
- Cabling & Instructions
- Mounting Hardware

Full Ht Drive	89⁹⁵
Full Ht Drive Ps/Case.....	129⁹⁵
Slim Line Drive.....	99⁹⁵
Slim Line Drive Ps/Case...	139⁹⁵
2 Slim Drives Ps/Case	239⁹⁵
Disk Controller	59⁹⁵

Single Ps & Case	44⁹⁵
Dual 1/2ht Ps & Case	54⁹⁵
Dual Full Ht. Ps & Case	79⁹⁵
Disk Controller	59⁹⁵
10 Diskettes with free library case	9⁹⁵

Dealer Inquiries Invited

617-278-6555

We welcome

- Visa/Mastercard 
- Checks (allow 2 weeks for clearing)
- C.O.D. Add \$2.



TRUE DATA PRODUCTS

9 South Main Street
Uxbridge, MA 01569
617-278-6555

Hours: Mon.-Sat., 9-6 (EST)

Call us today! **617-278-6555**

Order Toll Free **1-800-635-0300**

the line number is displayed, along with the count for that line number. This gives us a way to read out the line number for interesting lines.

The program to display the table after execution is shown in Listing 3. It scans the &H7000 table by moving four bytes at a time. For each move the line number is read from the first two table bytes and the count from the next two. The count is used to draw a vertical line whose length represents the size of the count.

Cursor movement is handled by reading in a key press with an INKEY\$ statement. If the right arrow (Code 9) has been pressed, the cursor is moved to the right and the line number and count displayed. If the left arrow (Code 8) has been pressed, the cursor is moved to the left and the line number and count displayed. All other key presses are ignored.

The (Shudder) Assembly Language Code

So far we have a BASIC program to initialize the table and to display the graph after program execution. The only thing missing is the program to increment the counts. Since the interrupts occur every 16.7 milliseconds, this program must be in assembly language, the only language fast enough to handle the interrupts.

Assembly language is tedious to learn and difficult in which to program. On the other hand, it's *fast!* Radio Shack currently puts its faith in the OS-9 assembler, discontinuing the excellent *EDTASM+* assembler that runs without OS-9. If you're not an OS-9 fanatic, I'd suggest getting a copy of *EDTASM+* — it's a great package on which to cut your assembly language teeth.

Every one-sixtieth of a second, an IRQ interrupt comes in. The assembly language code must get the current BASIC line number being executed, scan the table for that line number, and then bump by one the count for that line number entry. If a zero line number is encountered, the line number is assumed not to be in the table; the program doesn't do an increment. Line numbers equal to or greater than 10000 are also not incremented. After this action the assembly language code transfers control to the normal IRQ code.

The listing for this assembly language code is shown in Listing 4. The 6809 microprocessor has four registers that are used here. The Y register holds only a zero value, which is loaded in the first instruction. This value is used to test for the Line 0 and cause an exit.

The X register points to the next entry in the table. The table starts at &H7000, but the X register is initialized to &HGFFC, four bytes less. This is because the increment is made before the test.

The D register — the 16-bit equivalent of the eight-bit A and B registers joined together — hold the current line number. The current line number is picked up from one of those mysterious BASIC variables found in locations &H68 and &H69.

Each time through the LOOP, an LEAX +4, X instruction is executed. This adds four to the X register. The line number in D is then compared to the location pointed to by the X register. If the two values are not equal, the instruction at NFND tests the value in Y (0) against the location pointed to by X. If these are not equal, the end of the table has not been reached; the LOOP is reexecuted.

If the line number is found, the count at locations +2 and +3 from the location pointed to by the X register is bumped by one count. This must be done by loading the count into the D register (remember that the count is 16 bits), adding

one to the D register (ADDD #1) and storing the D register back to the table.

After the increment of the count (or if the line is not found) a JMP \$DBAF transfers control to the normal IRQ interrupt routine.

When 640 lines are in the program to be tested, the table search takes about 8 milliseconds, leaving half the time left over for program execution. This is a "worst-case scenario," as typical programs will be less than 640 lines.

Relocation

The assembly language program consists of 32 bytes of machine language code on the left (10BE . . . DB). This code is the executable form of the assembly language listing. It must be transferred to the protected memory area, starting at Location &HGFAF. The final program shown in Listing 5 does this by using pokes for each value. (Normally this would be done with DATA statements and a READ/POKE loop, but we don't want to have the program interfere with DATA statements in the program to be tested.) Each poked value corresponds to a machine language byte, transferred during the initialization portion of the program. Once in the protected memory area, they stay there until power is turned off.

Please Break This Chain!

The interrupt vector for the IRQ interrupt processing subroutine is found in the three bytes at &H10C. These three bytes are a machine language JMP instruction, with the last two bytes indicating the jump address.

The normal way to break an interrupt vector like this is to disable interrupts and put the new address into the second and third bytes of the JMP. Interrupts are disabled by the machine language TFR instruction that resets an interrupt bit in the Condition Codes register. Because this is tedious to do from BASIC, we made certain that the machine language program started at a location matching the second address byte of the normal interrupt processing subroutine.

The normal interrupt subroutine in the CoCo 3 starts at &HDBAF. By making our routine start at &HGFAF, only the first byte has to be changed. (Consider what would happen if this were not done: Assuming the new interrupt routine is at &HGFA0, the BASIC program changes the second byte of the JMP \$DBAF to &HGFA. Now an IRQ interrupt comes in. The microprocessor executes the JMP, which is now a JMP &HGFAF, 15 bytes into the new routine. Disaster ensues.) In most cases BASIC may be able to change both bytes without an IRQ interrupt coming in, but this approach is better programming practice.

The code in Listing 5 breaks the normal interrupt link by putting the new address of &HGFAF into Location &H10D. The last instruction of our new routine, don't forget, transfers control to Location &HDBAF, the original routine. We were able to sneak our processing in before the normal routine, which still works.

Using the Program

To use the program, merge the program to be tested with the code from Line 10000 onward. Also change or add a CLEAR statement to the program to be tested: 100 CLEAR B00, &HGFAE. At the end of the program to be tested, add a GOTO 10000.

After the two programs have been merged, RUN 10000.

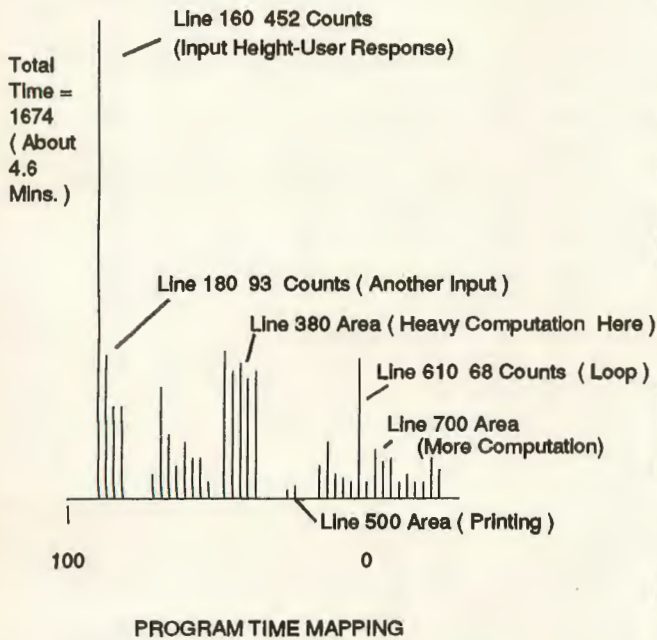

Figure 7: Typical Analysis Display

Choose I in response to the prompt "Initialize or Analyze (I or A)." The *Time Analyzer* program will scan all lines below 10000 and build a table in the &H7000 area. Break the program after the next prompt, and run the program to be tested as usual.

If you have added a GOTO 10000 at the end of the program to be tested, the program will automatically jump to the prompt message again. This time select A for Analyze. At this point all the counts during program execution have been accumulated. The Analyze function now displays the results. Move the cursor to investigate individual line counts. The total program time in one-sixtieth-second increments is displayed on the left of the screen.

When using the program for inputs, try to avoid long delays in entering data. The program scales the Y plot lines based upon the maximum counts, and INPUT statements with long user inputs diminish the plot of the other lines.

Summation

It's fascinating to see how long it takes to test different lines in the program. The display is perfect for finding critical timing problems. You can see which lines are taking the longest and take steps to correct the problem. Figure 7 shows a typical analysis display; this one is for the *Findmaze* program in my February 1988 RAINBOW column (Page 171). This is an 84-line program with a good mix of different types of statements. Note that user input and printing take a relatively long time compared to computation.

That's it! That wasn't so bad, was it? Did you survive? *Hey, are you listening? YOU OUT THERE...* See you next month with more CoCo topics. □

SolidDrive™ by Vidicom Corp

SolidDrive™ - a ramdisk that doesn't forget! Fully Static, battery backed CMOS ram makes SolidDrive™ ready to use instantly. You can forget formatting and copying work files to ramdisk then copying back your changes to floppy. You can forget fear of power failures. The instant power loss occurs, SolidDrive™ write-protects itself and your valuable work. SolidDrive™ gives you state-of-the-art surface mount technology. That's why we have the best guarantee in the industry - Two years limited repair or replacement! SolidDrive™ is compatible with Multi-Pak® and comes complete with OS9® Level I or II device driver, formatter and self-test software. Available in 512K and 1 Megabyte versions. Factory upgrades available for 512K version. RSDos Driver now available, treats SolidDrive™ as 3 or 6

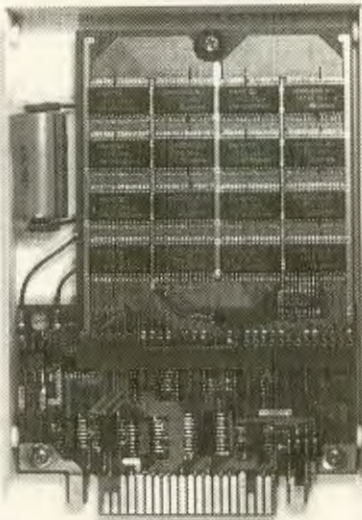

SolidDrive™ by Vidicom Corp
512K (524,288 bytes) \$395.00
1 Meg (1,048,576 bytes) \$695.00
Please add \$4.00 shipping
Arizona Residents add 5.5% Sales tax
Visa MasterCard orders welcome

Vidicom Corp 20 E. Main St. Suite 710
Mesa, AZ 85201 (602) 827-0107
Hours M-F 9:00 am - 5:00 pm MST

SSSD RS devices (4-6,4-9), Disk loaded version free on request! 27C64 EProm version \$19.00

SolidDrive™ is the fastest, most reliable long-term storage available to the small computer user!

OS9 is the trademark of Microware Systems Inc and Motorola Inc. Multi-pak is the trademark of Tandy Corp.



EZ FRIENDLY

For Your CoCo 1, 2, & 3

Leonardo's Pencil

(Reviewed in Oct. 87 RAINBOW) Makes programming sensational-looking graphics as easy as moving a joystick! Converts precision drawings into "DRAW" commands which can be stand-alone BASIC programs or merged into other programs. Also includes "DEMO" and "PAINT" programs. Requires a spring-centered joystick or touch-pad. 32k ECB tape or disk \$14.95

? ENIGMA?

Transform your computer into an ultra-secret code machine capable of enciphering and deciphering in over 12 million virtually unbreakable codes! (not simple substitution codes). Print hard copy or store & retrieve coded data on tape or disk. Only the person who has the password can read it! 32k ECB tape or disk \$12.95

New! EZ Writer

Just answer the prompts & type your message; "EZ WRITER" will put it into perfect letter form and send it to your DMP or DWP. Professional-quality, 1 to 4 page letters every time! Do one letter or multiple copies for "personalized" mailings. Saves letters and mailing lists. Even does labels. Menu-driven. Undoubtedly the EZ-est letter writing system available! Free sample on request! 32k ECB tape or disk \$19.95

(MATH GAMES)

FOUR superior educational "games": "RACEWAY", "GO TO THE TOP" (multiplication tables drill), "WORD PROBLEMS", & "PYRAMID". Covers addition, subtraction, multiplication, & division. Different levels of difficulty. Exciting graphics & sounds. EZ and fun! 32k ECB tape or disk \$19.95

KEYBOARD COMMANDER

Probably the most exciting typing tutor available for your CoCo. You are the commander of a space ship & it's your job to shoot down alien letters & words as they speed toward you & attack your spaceship. Exciting Hi-Res action! 32k ECB tape or disk \$24.95

E.Z. FRIENDLY SOFTWARE

118 CORLIES AVE. • POUGHKEEPSIE, NY 12601 • (914) 485-8150
(Add \$1.50 s/h to all orders. NY residents add state sales tax.)

Listing 1: PRNTLINE

```

100 ' PRINT LINE NUMBERS
110 TC = 0
120 I = PEEK ( &H19 ) * 256 + PEEK( &H1A )
130 L = PEEK( I ) * 256 + PEEK( I + 1 )
140 NO = PEEK( I + 2 ) * 256 + PEEK( I + 3 )
150 IF L = 0 THEN GOTO 200
160 PRINT NO,
170 I = L
180 TC = TC + 1
190 GOTO 130
200 PRINT: PRINT TC; "LINES"
210 END

```

Listing 2: LINETABL

```

100 ' FIND LINE NUMBERS AND PUT IN TABLE
110 CLEAR 8000, &H6FAE
120 J = &H7000
130 I = PEEK ( &H19 ) * 256 + PEEK( &H1A )
140 L = PEEK( I ) * 256 + PEEK( I + 1 )
150 NO = PEEK( I + 2 ) * 256 + PEEK( I + 3 )
160 IF ( L <> 0 ) AND ( NO < 10000 ) THEN GOTO 200
170 POKE J, 0: POKE J + 1, 0
180 PRINT: PRINT ( J - &H7000 ) / 4; "LINES"
190 END
200 PRINT NO,
210 POKE J, PEEK( I + 2 ): POKE J + 1, PEEK( I + 3 )
220 POKE J + 2, 0: POKE J + 3, 0
230 J = J + 4: IF J > &H7000 + 256 THEN PRINT "PROGRAM > 640 LINES": STOP
240 I = L
250 GOTO 140

```

Listing 3: ANALYZE

```

10340 ' ANALYZE PORTION
10350 HBUFF 1, 400
10360 TC = 0: MC = 0: TT = 0
10370 ' COUNT LINES AND FIND MAX VALUE IN TABLE

```

```

10380 FOR I = &H7000 TO &H7FFE STEP 4
10390 NO = PEEK( I ) * 256 + PEEK( I + 1 )
10400 CT = PEEK( I + 2 ) * 256 + PEEK( I + 3 )
10410 IF NO = 0 THEN GOTO 10470
10420 TC = TC + 1
10430 TT = TT + CT
10440 IF CT > MC THEN MC = CT
10450 NEXT I
10460 ' DRAW GRAPH
10470 HSCREEN 4
10480 HCLS
10490 HPRINT ( 2, 5 ), "TOTAL TIME=" + STR$( TT )
10500 HGET ( 0, 0 ) - ( 160, 7 ) , 1
10510 D = ( 640 - TC ) / 2
10520 IF MC = 0 THEN YS = 0 ELSE YS = 150 / MC
10530 HPRINT ( 30, 23 ), "PROGRAM TIME MAPPING"
10540 FOR I = 1 TO TC
10550 Y = PEEK( &H7002 + ( I - 1 ) * 4 ) * 256 + PEEK( &H7003 + ( I - 1 ) * 4 )
10560 HLINE ( D + I, 160 ) - ( D + I, 160 - INT( Y * YS ) ), PSET
10570 NEXT I
10580 ' MOVE CURSOR AND PRINT LINE AND COUNT
10590 X = D + 1: Y = 162: I = 1: C = 0
10600 HLINE ( X, 162 ) - ( X, 170 ), PSET
10610 HPUT ( 272, 176 ) - ( 432, 183 ), 1, PSET
10620 HPRINT ( 34, 22 ), PEEK( &H7000 + ( I - 1 ) * 4 ) * 256 + PEEK( &H7001 + ( I - 1 ) * 4 )
10630 HPRINT ( 42, 22 ), PEEK( &H7002 + ( I - 1 ) * 4 ) * 256 + PEEK( &H7003 + ( I - 1 ) * 4 )
10640 A$ = INKEY$: IF A$ = "" THEN GOTO 10640
10650 IF A$ = CHR$( 8 ) THEN X = X - 1: I = I - 1: IF I < 1 THEN X = X + 1: I = I + 1 ELSE HLINE( X + 1, 162 ) - ( X + 1, 170 ), PRESET
10660 IF A$ = CHR$( 9 ) THEN X = X + 1: I = I + 1: IF I > TC THEN X = X - 1: I = I - 1 ELSE HLINE( X - 1, 162 ) - ( X - 1, 170 ), PRESET
10670 GOTO 10640

```

Listing 4:

6FAF		00100	ORG	\$6FAF	
6FAF 108E	0000	00110	START LDY	#0	TERMINATOR
6FB3 8E	6FFC	00120	LDX	#\$6FFC	START OF TABLE-4
6FB6 DC	68	00130	LDD	\$68	GET CURRENT LINE #
6FB8 30	04	00140	LOOP LEAX	+4,X	BUMP TO NEXT ENTRY
6FBA 10A3	84	00150	CMPD	,X	COMPARE LINE #S
6FBD 26	09	00160	BNE	NFND	GO IF NOT EQUAL
6FBF EC	02	00170	LDD	+2,X	BUMP COUNT
6FC1 C3	0001	00180	ADDD	#1	
6FC4 ED	02	00190	STD	+2,X	
6FC6 20	05	00200	BRA	OUT	ON TO REST OF INT
6FC8 10AC	84	00210	NFND CMPY	,X	END?
6FCB 26	EB	00220	BNE	LOOP	GO IF NO
6FCD 7E	D8AF	00230	OUT JMP	\$D8AF	OUT TO INT PROCESSING
	6FD0	00240	LAST EQU	*	
	0000	00250	END		

Listing 5: TIMEFIND

10000 ' PROGRAM TIME ANALYZER	10030 INPUT "INITIALIZE OR ANALY
10010 CLS	ZE (I OR A)"; RE\$
10020 PRINT "PROGRAM TIME ANALYZ	10040 IF RE\$ = "A" THEN GOTO 103
ER"	50

NEW FOR OS-9™: FORTH09

from D. P. JOHNSON

FORTH09 is a FORTH-83 Standard implementation specially tailored for OS-9. Includes the double number extension word set, system extension word set, complete forth 6809 assembler and more. Programs written in forth can instantly be saved as compact executable machine language modules. The FORTH09 system runs on any level I or level II OS-9 (6809) machine with at least 32k of available memory and one disk drive. Saved Forth09 application code is romable, reentrant and fully position independent, requiring as little as 3k for a small program. Where maximum speed is required the user can force small code words to be automatically compiled as in line code rather than subroutines. Supplied with complete printed documentation. **\$150.00** (+ \$3 S&H) Specify disk format if other than CoCo OS-9 format desired.

Other OS-9 SOFTWARE from D. P. JOHNSON

L1 UTILITY PAK - Contains 40 useful utilities that run under both level I and II OS-9. Included are a complete set of "wild card" file handling utilities, a disassembler, a disk sector editor, and the MacGen command language compiler. MacGen will allow you to generate many useful command macros in minutes, much more useful than procedure files. Macro source is included for a macro to implement an archival backup type function. **\$49.95**

L2 UTILITY PAK - Contains a Level II "printerr" function that also shows the pathname being searched for when "not found" or permission type errors occur. Also contains level II software ram disk driver. Ten other utilities included, some useful for level I also. **\$39.95**

L1+L2 COMBINATION PAK both of above together for **\$75.00**

SDISK - Standard disk driver module replacement allows full use of 40 or 80 track double sided drives with OS-9 Level I. Full compatibility with CoCo 35 track format and access all other OS-9 non-CoCo formats. Easy installation. **\$29.95**

SDISK+BOOTFIX - As above plus boot directly from a double sided diskette. **\$35.95**

SDISK3 - Level II version of SDISK driver. Same features as level I (except bootfix not required to boot from double sided). **\$29.95**

PC-XFER UTILITIES - Programs to format and transfer files to/from MS-DOS™ diskettes on CoCo under OS-9. (Requires either SDISK or SDISK3 to run depending on which level of OS-9 you are using) **\$45.00**

MSF - MS-DOS disk format file manager. More complete file transfer capabilities for level II only. (Requires SDISK3 to operate). **\$45.00**

CCRD 512K byte RAM DISK CARTRIDGE - Operates faster than similar device sold by others. Requires RS Multipak interface, two units may be used together for 1MB. OS-9 Level I & II drivers and test software included. **\$CALL**

All diskettes are in CoCo OS-9 format unless otherwise requested; other OS-9 formats can be supplied for \$2.00 additional charge. All orders must be prepaid or COD, VISA/MC accepted, add \$1.75 S&H for first software item, + .25 for each additional item, \$5.00 for CCRD, additional charge for COD.

D. P. Johnson, 7655 S.W. Cedarcrest St., Portland, OR 97223 (503) 244-8152 (For best service call between 9-11 AM Pacific Time, Mon.-Fri.)

OS-9 is a trademark of Microware and Motorola Inc., MS-DOS is a trademark of Microsoft, Inc.

```

10050 ' INITIALIZE PORTION
10060 CLEAR 800,&H6FAE
10070 ' MOVE ML CODE
10080 POKE &H6FAF,&H10:POKE &H6F
B0,&H8E:POKE &H6FB1,&H00:POKE &H
6FB2,&H00
10090 POKE &H6FB3,&H8E:POKE &H6F
B4,&H6F:POKE &H6FB5,&HFC:POKE &H
6FB6,&HDC
10100 POKE &H6FB7,&H68:POKE &H6F
B8,&H30:POKE &H6FB9,&H04:POKE &H
6FBA,&H10
10110 POKE &H6FBB,&HA3:POKE &H6F
BC,&H84:POKE &H6FBD,&H26:POKE &H
6FBE,&H09
10120 POKE &H6FBF,&HEC:POKE &H6F
C0,&H02:POKE &H6FC1,&HC3:POKE &H
6FC2,&H00
10130 POKE &H6FC3,&H01:POKE &H6F
C4,&HED:POKE &H6FC5,&H02:POKE &H
6FC6,&H20
10140 POKE &H6FC7,&H05:POKE &H6F
C8,&H10:POKE &H6FC9,&HAC:POKE &H
6FCA,&H84
10150 POKE &H6FCB,&H26:POKE &H6F
CC,&HEB:POKE &H6FCD,&H7E:POKE &H
6FCE,&HDS
10160 POKE &H6FCF,&HAF
10170 ' CHANGE THE LS BYTE OF NM
I INTERRUPT VECTOR
10180 POKE &H10D, &H6F
10190 ' FIND LINES NUMBERS AND P
UT IN TABLE
10200 J = &H7000
10210 I = PEEK ( &H19 ) * 256 +
PEEK( &H1A )
10220 L = PEEK( I ) * 256 + PEEK
( I + 1 )
10230 NO = PEEK( I + 2 ) * 256 +
PEEK( I + 3 )
10240 IF ( L <> 0 ) AND ( NO < 1
0000 ) THEN GOTO 10280
10250 POKE J, 0: POKE J + 1, 0
10260 PRINT: PRINT ( J - &H7000
) / 4; "LINES"
10270 GOTO 10030
10280 PRINT NO,
10290 POKE J, PEEK( I + 2 ): POK
E J + 1, PEEK( I + 3 )
10300 POKE J + 2, 0: POKE J + 3,
0
10310 J = J + 4: IF J > &H7000 +
2560 THEN PRINT "PROGRAM > 640
LINES": STOP
10320 I = L
10330 GOTO 10220
10340 ' ANALYZE PORTION
10350 HBUFF 1, 400
10360 TC = 0: MC = 0: TT = 0
10370 ' COUNT LINES AND FIND MAX
VALUE IN TABLE
10380 FOR I = &H7000 TO &H7FFE S
TEP 4
10390 NO = PEEK( I ) * 256 + PEE
K( I + 1 )
10400 CT = PEEK( I + 2 ) * 256 +
PEEK( I + 3 )
10410 IF NO = 0 THEN GOTO 10470
10420 TC = TC + 1
10430 TT = TT + CT
10440 IF CT > MC THEN MC = CT
10450 NEXT I
10460 ' DRAW GRAPH
10470 HSCREEN 4
10480 HCLS
10490 HPRINT ( 2, 5 ), "TOTAL TI
ME=" + STR$( TT )
10500 HGET ( 0, 0 ) - ( 160, 7 )
, 1
10510 D = ( 640 - TC ) / 2
10520 IF MC = 0 THEN YS = 0 ELSE
YS = 150 / MC
10530 HPRINT ( 30, 23 ), "PROGRAM
TIME MAPPING"
10540 FOR I = 1 TO TC
10550 Y = PEEK( &H7002 + ( I - 1
) * 4 ) * 256 + PEEK( &H7003 +
( I - 1 ) * 4 )
10560 HLINE ( D + I, 160 ) - ( D
+ I, 160 - INT( Y * YS ) ), PSE
T
10570 NEXT I
10580 ' MOVE CURSOR AND PRINT LI
NE AND COUNT
10590 X = D + 1: Y = 162: I = 1:
C = 0
10600 HLINE ( X, 162 ) - ( X, 170
), PSET
10610 HPUT ( 272, 176 ) - ( 432,
183 ), 1, PSET
10620 HPRINT ( 34, 22 ), PEEK( &H7000
+(I-1)*4)*256 + PEEK( &H7001+(I-1
)*4 )
10630 HPRINT ( 42, 22 ), PEEK( &H7002
+(I-1)*4)*256 + PEEK( &H7003+(I-1
)*4 )
10640 A$ = INKEY$: IF A$ = "" TH
EN GOTO 10640
10650 IF A$ = CHR$( 8 ) THEN X =
X - 1: I = I - 1: IF I < 1 THEN
X = X + 1: I = I + 1 ELSE
HLINE( X + 1, 162 ) - ( X + 1,
170 ), PRESET
10660 IF A$ = CHR$( 9 ) THEN X =
X + 1: I = I + 1: IF I > TC THE
N X = X - 1: I = I - 1
ELSE HLINE( X - 1, 162 ) - ( X -
1, 170 ), PRESET
10670 GOTO 10600

```

XTEAM & OS-9

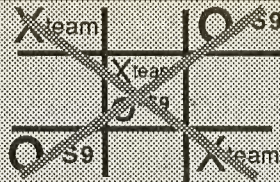

BOTH WINNERS

All of our OS-9 products work with:
OS-9 version 1
OS-9 version 2
OS-9 Level 2

XTERM

- Menu oriented
- Upload/download Ascii or XMODEM protocol
- Execute OS-9 commands from within XTERM
- OS-9 Communications program
- Definable macro keys
- Works with standard serial port, RS232 Pak, or PBJ 2SP Pak, Includes all drivers
- Works with standard screen, Xscreen WORDPAK or DISTO 80 column board

\$49.95 with source **\$89.95**

XDIR & XCAL

- Hierarchical directory
- Full sorting
- Complete pattern matching
- OS-9 calculator
- Decimal, Hex, Binary
- +, -, *, /, AND, OR, XOR, NOT

\$24.95 with source **\$49.95**

XDIS

OS-9 disassembler

\$34.95 with source **\$54.95**

HARDWARE

- 512k memory upgrade **\$80.00**
 - Ram Software
 - Ram Disk
 - Print Spooler
 - Quick Backup
- All three for only **\$19.95**

*Software by Color Venture

XWORD

OS-9 word processing system

- Works with standard text screen, XSCREEN, WORDPAK, or DISTO
- True character oriented full screen editing
- Full block commands
- Find and Replace commands
- Execute OS-9 commands from within
- Proportional spacing supported
- Full printer control, character size, emphasized, italics, overstrike, underline, super/sub-scripts
- 10 header/footers
- Page numbering in decimal or Roman numerals
- Margins and headers can be set different for even and odd pages

\$69.95 with source **\$124.95**

XMERGE

Mail merge capabilities for XWORD

\$24.95 with source **\$49.95**

XSPELL

OS-9 spelling checker, with 20000 and 40000 word dictionaries

\$39.95

XTRIO

XWORD/XMERGE/XSPELL

\$114.95 with source **\$199.95**

XED

OS-9 full screen editor

\$39.95 with source **\$79.95**

AND FOR RS DOS ...

SMALL BUSINESS ACCOUNTING

This sales-based accounting package is designed for the non-accountant oriented businessman. It also contains the flexibility for the accounting oriented user to set up a double entry journal with an almost unlimited chart of accounts. Includes Sales Entry, transaction driven Accounts Receivable and Accounts Payable, Journal Entry, Payroll Disbursement, and Record Maintenance programs. System outputs include Balance Sheet, Income Statement, Customer and Vender status Reports, Accounts Receivable and Payable Aging Reports, Check Register, Sales Reports, Account Status Lists, and a Journal Posting List.

\$79.95

INVENTORY CONTROL/SALES ANALYSIS

This module is designed to handle inventory control, with user defined product codes, and produce a detailed analysis of the business' sales and the sales force. One may enter/update inventory data, enter sales, run five sales analysis reports, run five inventory reports, set up product codes, enter/update salesman records, and update the SBAP inventory.

\$59.95

Call for package price

PAYROLL

Designed for maintaining personnel and payroll data for up to 200 hourly and salaried employees with 8 deductions each. Calculates payroll and tax amounts, prints checks and maintains year-to-date totals which can be automatically transferred to the SBA package. Computes each pay period's totals for straight time, overtime and bonus pay and determines taxes to be withheld. Additional outputs include mailing list, listing of employees, year-to-date federal and/or state tax listing, and a listing of current misc. deductions. Suited for use in all states except Oklahoma and Delaware

\$59.95

PERSONAL BOOKKEEPING 2000

Handles 45 accounts. Enters cash expenses as easily as checks. Handles 26 expense categories. Menu driven and user friendly.

\$39.95

ACCOUNTS RECEIVABLE

Includes detailed audit trails and history reports for each customer, prepares invoices and monthly statements, mailing labels, aging lists, and an alphabetized customer listing. The user can define net terms for commercial accounts or finance charges for revolving accounts. This package functions as a standalone A/R system or integrates with the Small Business Accounting package.

\$59.95

ACCOUNTS PAYABLE

Designed for the maintenance of vendor and A/P invoice files. The system prints checks, voids checks, cancels checks, deletes cancelled checks, and deletes paid A/P invoices. The user can run a Vendor List, Vendor Status report, Vendor Aged report, and an A/P Check Register. This package can be used either as a standalone A/P system or can be integrated with the Small Business Accounting Package.

\$59.95

MICROTECH CONSULTANTS INC.

1906 Jerrold Avenue
St. Paul, MN 55112

Dealer Inquiries Invited
Author Submissions accepted
OS-9 is a trademark of Microware



Ordering Information

Add \$3.00 shipping & handling, MN residents add 6% sales tax.
Visa, Mastercard, COD (add \$3.50), personal checks.

(612) 633-6161



KISSable OS-9

Volunteers Build a Better Mousetrap

By Dale L. Puckett
Rainbow Contributing Editor

The OS-9 wizards stole the show at our RAINBOWfest Chicago seminar. Two products demonstrated by Kevin Darling, Mark Griffith, Ron Lammardo and Kent Meyers redefined ease of use for Color Computer OS-9. Several others were spectacular and brought oohs and ahhs from the crowd. Most importantly, however, these OS-9 Users Group members have released their work into the public domain and were distributing it to Users Group members at RAINBOWfest Chicago.

We were also fortunate enough to interview a rising young star in the Color Computer OS-9 community. We'll share Chris Burke's views with you this month and then move on to get you started with a few lines of code that may soon become *Gfx3*.

During our seminar, Darling and Lammardo put the new Kent Meyers *GShell* through its paces. The new addition to the OS-9 Users Group Software Library contains six files as well as the *ar* and *ipatch* utilities you

Dale L. Puckett, a freelance writer and programmer, serves as director-at-large of the OS-9 Users Group and is a member of the Computer Press Association. His username on Delphi is DALEP; on packet-radio, K0HYD @ N4QQ; on GENie, D.PUCKETT2; and on CIS, 71446,736.

need to install them. They include:

<i>GShell</i> .ipc	an <i>Ipatch</i> file
<i>CC3io</i> .ipc	an <i>Ipatch</i> file
<i>Scf</i> .ipc	an <i>Ipatch</i> file
<i>Gsort</i>	a new command for the file
<i>MenuCopy</i>	a replacement for Tandy's <i>copy</i> command
<i>Free</i>	a replacement for Tandy's <i>free</i> command

You must purchase OS-9 Level II and *Multi-Vue* from Tandy to get the original *GShell*, *CC3io* and *Scf* files you'll be patching. These programs have been copyrighted by Microware and Tandy, and you may not distribute them. The *ipatch* files are in the public domain, however, and may be passed around freely as long as no files from OS-9 Level II or *Multi-Vue* are included. The three new utility commands are all in the public domain.

Here are some of the new features the crowd saw at our OS-9 seminar. Typing *S* when the *GShell* window is active pops up an overlay window and starts a standard OS-9 Shell. You can then run OS-9 from the command line to your heart's content. Return to *GShell* by holding down the CTRL key and striking the BREAK key.

If you select any file or directory on the *GShell* screen by pointing to it and clicking once, you can delete it by

moving the mouse pointer to the trash can icon and clicking again. The new *GShell* deletes the file immediately without asking you if you are sure. It uses the OS-9 *Del* utility to delete a file and the *DelDir* utility to delete a directory.

If you double click on any text file icon, *GShell* assumes it is a valid OS-9 procedure file and attempts to execute it as a shell script. If you try to execute a file that does not contain a shell script, OS-9 will print an error message.

If you double click on any program icon, *GShell* will run the program for you after asking for any parameters. *GShell* knows a file is a program when it finds the *execute* attributes set. Additionally, you may now list and print an AIF file by selecting it and using the appropriate command in the Files menu.

You'll find a new command in the Files menu now. *Sort* causes all files in the directory displayed to be sorted in ASCII order. This means your AIF files always move to the beginning of a directory and appear in the first screen.

You'll notice another convenience when you need to answer the infamous "Are you sure?" prompt. The "sure" box is now displayed on the screen very close to the last position of the mouse pointer. Before, it was always displayed near the center. This Kent Meyers addition will help you keep your mouse movements to a minimum.

If all of these new features aren't enough, hang on to your hat — there's more! Directory names longer than the directory bar now scroll to the left. Graphics Put buffers in use are now killed on entry and exit. A black border has been added to all *GShell* and Tandy menu shells. You may also select a 16-color 40-by-24 window from the View menu.

Since Meyers is a stickler for detail, all *GShell* prompts now start with capital letters. This makes them look more professional. Adding a question mark in the second line of an AIF file now causes *GShell* to prompt you for parameters before executing the program. And if you find a prompt on your screen and don't have an answer, clicking the mouse will cause the prompt to go away and the function you were running to be aborted.

When you do have something to say, you'll have more room. Meyers has expanded the size of the "Parameters for" box by 10 spaces. If you click on a file icon that has an AIF file associated with it, the program name, parameters and finally the filename are sent to the shell.

Clicking first on any program file icon and then clicking on the question mark in the upper right corner of the menu bar, or selecting the Help command from the Tandy menu, gives you help for that program — if it's available in the help file in your system directory.

Additionally, programs that run in *GShell*'s overlay window now run with the mouse and the graphics pointer turned off. This makes them much faster. When a display scrolling in the *GShell* overlay window pauses, it can be restarted by clicking the mouse. To use this option you must patch the CC3io and Scf modules with the files on the disk. The bug that once caused your window to disappear when you quit *GShell* after starting it with Multi-start or AutoEx has been fixed.

While he was adding these new features, Meyers optimized *GShell+* and removed all the bugs he could find. *GShell+* is far more reliable than the original version and much faster. The CC3io and Scf patch files on the disk give you the following features and fixes:

CoCo 3 defaults to montype RGB when you boot OS-9.

A palette register problem has been fixed.

Condemned processes are killed automatically.

The mouse button can be used to un-pause a screen.

The un-pause feature also works outside of *GShell* in any OS-9 window or SCF-type device.

Following the *GShell* demonstration Ron Lammardo answered questions about the new *Shell+* he masterminded and helped develop. The Users Group distributed Version 1.3a on the GShell disk at RAINBOWfest.

After Lammardo spoke, Kevin Darling stole the show by playing an audio cut from *Star Trek*. He then held the microphone to the CoCo 3 speaker while he played an additional dozen sounds, including the infamous blurb that describes more than one writer on deadline: "I'm trying to think, but nothing happens!"

Darling also awed the crowd with a few animated high-resolution graphics screens. In one, a waterfall lulls you with its serenity. In another, a jet flies over the earth's surface at varying speeds. The player program doing the work was named *Vefio*. Darling played back the images by double clicking on *Multi-View* icons.

Mark Griffith wrote the new Copy command distributed by the Users Group at Chicago. It is a direct replacement for the standard copy utility. However, it works only with *Multi-View*. Run Griffith's Copy by selecting a file and then choosing Copy on the Files menu. The first thing you'll see is a pop-up overlay window. If you are copying a file to the same directory, you need only type a filename. If you want to make a copy in another directory or on another disk, you type just the device name and directory. You no longer need to retype the filename you selected earlier with the mouse. If the new name you type already exists, an overlay window will pop up, and you'll be asked if you want to overwrite the existing file.

While the OS-9 wizards were wowing the seminar crowd, Tony DiStefano was doing the same with his new Super Controller II at the CRC booth. This board does not halt the 6809 processor while it is reading from or writing to the disk. This returns OS-9's type-ahead feature to the Color Computer.

Kevin Darling wrote the OS-9 drivers for CRC. We picked up a final production copy of Darling's drivers at Chicago and while reading the manual on the flight back to Washington, came across a discussion of the infamous "OS-9 Boot file order problem." Here's a common problem: Your new disk

won't boot under Level II. Before you blame your new controller or your Color Computer, answer the following questions:

Have you remembered to include a CMDS directory on your boot disk?

Does it contain a Shell file and Grfdrv?

Are the execution permissions set: attr /d0/cmds/shell e pe?

This is a pretty common problem, even among the oldtimers. If you answered the questions above correctly, you may have stumbled into the infamous "boot order" failure. Here are the symptoms: Your disk fails to boot at all, or — more often — when you format a disk you wind up with many Read Errors.

All the major Level II third-party software and hardware makers are aware of this problem, but so far, no one has come up with a satisfactory explanation. It happens most often when you add a new module to your boot list or Config list. Theoretically, since all OS-9 code is position-independent, it shouldn't matter where a driver module ends up. There are many theories about what causes this failure, but the only known "fix" is to rearrange the order of the modules in your OS-9 Boot file.

CRC distributes one of Darling's programs, *DirM*, to help you determine a possible boot order if you run into trouble. *DirM* is similar to *Mdir*, except it reports the actual RAM block numbers that hold your modules. The prevailing theory is that RBF, CC3Disk, DD, D0, D1, as well as other RBF drivers and descriptors, should all end up with the same block number when you boot up.

If you have a problem but can boot up, run *DirM*. Note the first number on the lines for those modules. If they differ, you may have found the trouble. Try another Os9gen boot list order by using your editor to move a module name or two in your boot list file — either from before the RBF modules to after them or vice versa. Remember, your goal is to make those RBF-type modules wind up in the same 8K block of memory.

A common first try is to simply move the Init module to the end of the list. This has worked for many people. Because no one actually knows what causes this problem, Darling recommends that you do not make backups of important disks until you've tried out the drivers for a couple of days. How-

RSDos -cmd [-mod] device-name [DOS-path] [OS9-path] Switches

-dir for a directory listing of an RS-DOS disk
-get to import a file from an RS-DOS disk
-del to delete a file from an RS-DOS disk
-put to export a file to an RS-DOS disk

Modifiers

-b for type 0: BASIC binary type program
-d for type 1: BASIC data file
-m for type 2: executable machine language program
-t for type 3: text editor source file
-a for ASCII format (default is binary)
-f=n sets the file type to n (n = 0-255)

Figure 1

ever, if you can format new disks with no difficulty and can copy large files such as OS9boot to another disk without errors, you are most likely in good shape.

When you buy the Super Controller II, you get several extra utilities. RS-DOS from Ipatch author Bob Santy is one that is sure to please. This import/export utility displays directories, transfers files to and from a Color Computer RS-DOS diskette and deletes files from RS-DOS diskettes.

The syntax and a list of switches and modifiers accepted by RSDos.os9 are shown in Figure 1.

Tony DiStefano plans to add a combination clock, parallel port and serial port card to the Disto lineup soon. This card can be installed inside the SC-II and means you may no longer need to use the Multi-Pak Interface. Rumor control has it that another board with four devices will be available from CRC in the not-too-distant future.

FD 502 Double-Sided 40-track Secondary Drive Fix

When I read Kevin Darling's description of the boot list order problem in the Disto Super Controller II driver documentation, it reminded me of another problem he mentioned. The Color Computer normally turns on both drive motors, even though it selects only one drive for access at a time. This ensures that when you are running a copy utility to move files between drives, you need not wait for a drive to spin up to 300 rpm each time your program switches from Drive 0 to Drive 1. Because of this convention, all disk drivers for the Color Computer assume that all drives are ready to use if the motor line is on. In the past this has been true.

Now for the "gotcha!" The second disk drive used in the two-drive FD 502 cases has a jumper inadvertently misplaced. These drives ignore the motor line and spin only when selected. This means that every time you see your Drive 1 light go on, it takes a fraction of a second for it to get up to speed. When the light goes out, the drive stops. This makes disk operations unreliable.

You may not have a problem while running RS-DOS programs because they normally run at 1 MHz. If you are using OS-9 with the vanilla Level II CC3Disk module, you may have occasional problems — especially when copying from /D0 to /D1. If you are using the new Disto Super Controller II with the no-halt drivers, you must fix the jumper.

To see if your drive acts this way, loosen the four outside screws that hold the case together. Observe the top of Drive 1 while trying POKE &HFF40,2. If the motor and light come on, you need to change the jumper. To do this, remove the top drive. Remove the two screws holding the fan and lay it back out of the way. Now, pull off the black/yellow/red power cable and the main 34-wire control cable. Slide the drive out, being careful to hold it up so it doesn't fall on the bottom drive. Remove the two flat plastic head/sensor cables that connect to the circuit board by lifting up on the top of the plastic block they plug into. This releases the tension lock on the cables so that they will pull out easily.

Also, remove the four-pin cable that leads forward to the index-hole and write-protect sensors. Flip the drive over and remove the three screws that hold the circuit board. Remove the two cables attached to the motors. Look at

the top of the circuit board, and note where the cable to the controller plugs in. You should see two small bare-wire jumpers soldered to the board; ignore the one near Pin 34. On the side nearest Pin 2 of the 34-pin edge card, in one of two sets of holes marked '5' you'll find another. Remove or clip it, then run a wire between the other marked set of holes. Be careful when you solder in the new jumper.

Put everything back together and type POKE &HFF40,2. The light should come on, but the motor will not be running. Now type POKE &HFF40,8. The motor should come on but the light should stay out. Try POKE &HFF40,10. The motor and light should both come on. Finally, type POKE &HFF40,0. Both the motor and light should go off — you passed the test!

Chris Burke — A Rising OS-9 Star

Chris Burke and his wife, Trisha, sell OS-9 and RS-DOS hard disks and OS-9 utilities. They live in Schaumburg, Ill., only two miles from the site of RAINBOWfest Chicago. Their Color Computer adventure began in 1982 when they bought a Color Computer with Level I OS-9 for \$500. They bought it because it was the least expensive graphics-based computer available at the time and because the 6809 is a good processor. "I couldn't find a better value anywhere," Burke said.

Burke started out writing programs in Extended Color BASIC, but he soon added OS-9 and discovered that he really liked it. "OS-9 was like UNIX, and I was familiar with UNIX. OS-9 made a lot of sense because of its modular structure.

"Before long, I set up some quad density drives and got involved with the local OS-9 Users Group. I made a presentation one evening to show them how to put these big drives on the CoCo. A lot of people went out and did it. I wrote a lot of 'fun' OS-9 stuff — device drivers, etc. — and added a lot of hardware. I even built something like the Super Board. But I still wasn't in business," Burke said.

Burke thought the quad density drives were nice but decided he needed something more. "I saw a few hard drives advertised in RAINBOW for about \$900," he said. "Unfortunately, that was out of the question — I didn't have that kind of money. Luckily, I noticed a few drives advertised in Byte magazine for \$450 a few months later. I knew a little bit about the drives, so I went to work and got OS-9 Level I running on a hard

drive. Then I got OS-9 Level II and wrote another driver.

"This was about two years ago and we still weren't in business, but about that time, Trisha and I noticed one of Marty Goodman's columns in RAINBOW. He was telling why Color Computer hard drives were so expensive, while IBM hard drives were cheap. We were already using an IBM drive on our Color Computer, so the 'light' went on and we decided to go in business. Our only product was an OS-9 hard disk interface called the CoCo-XT."

Burke still doesn't sell the drives — just the interface and the software. He hasn't jumped into this arena because he believes everyone knows you can still get a better deal on an IBM drive through one of the large discount houses. Later Burke added a real-time clock with battery backup to his XT and called it the XT-RTC.

He showed both interfaces at local computer clubs and RAINBOWfest Princeton. "That was our first public offering, and our products were well-received. A few people were hesitant because they had never heard of us before; when they saw our \$450 price, they thought we were setting them up. Then people started calling and asking if they could sell for us — Sugar Software, Howard Medical, FHL all wanted to sell Burke's hard disk interface.

"Before we came along, hard disks had been a closed market. For a long time there was only Owl-Ware. Then Disto added a hard disk interface to its line. Ours was something dealers could sell, so we put it in distribution immediately."

After this initial success, Chris and

Trisha started expanding their product line. They added *Hyper-IO*, a program that lets you use a hard drive under BASIC. It is OS-9 compatible and stores an entire floppy image as one OS-9 file. You can delete or add a whole floppy at the same time. This means you can run OS-9 and RS-DOS programs from the same hard drive, although not concurrently. *Hyper-IO* gives RS-DOS users the advantage of making their floppy images any size.

The floppy on your hard disk can look like a double-sided 80-track, a 3-megabyte drive, or whatever. Another nice thing about *Hyper-IO* is the fact that it gives you the ability to add utilities to transfer files from OS-9 to RS-DOS — on a hard drive or a floppy. Burke also gives you a patch that lets the OS-9 assembler create RS-DOS programs. After you assemble them, you can copy them to an RS-DOS directory.

Yet, for Burke, *Hyper-IO* was only a beginning. Before long, he found himself designing *RSB*, which stands for *Radio Shack BASIC*. "People say they don't like OS-9 because it's hard to use and hard to learn," Burke said. "I don't believe it is hard to use. I believe it's different from what they have learned. What they mean when they say OS-9 is hard to use is that when they type `run game` it doesn't work."

RSB uses the same command syntax as *Hyper-IO*, but it runs in an OS-9 shell. All of the *Radio Shack Basic* graphics commands have been modified to use OS-9 Level II system calls. "When you run *RSB* the first time, we take the BASIC code in ROM and move it to your hard disk," Burke said. "Then we patch the I/O drivers to make system

calls and patch the code to make it relocatable. Since we only had to change about 10 percent of code, *RSB* was a reasonable project."

Burke's goal is to make OS-9 appear friendly to people who use RS-DOS regularly. He believes that once they start using *RSB*, they will become familiar with OS-9's features — the spoolers, hard drives, additional serial ports, etc. — because *RSB* uses OS-9 drivers. "At the same time they are running *RSB*, they will be able to flip over to another window and use an OS-9 application program. In fact, because of OS-9 *RSB* users will even be able to run several different RS-DOS programs in different windows at the same time. All of this will be going on concurrently!" Burke said.

Burke is presently working on *MUSE*, an `Scf` driver for music that will play a string from *RSB*. Since he is writing it as a device driver and device descriptor named `/MU`, you will be able to use it with your Radio Shack Sound Pack or the Super Voice cartridge from Speech Systems. In fact, you will have a no-halt music device in a sense, because the two boards take a string and play it. The Level II internals will generate the sounds.

Another OS-9 utility marketed by Burke & Burke is *EZGen*, a boot file editor similar to the Sugar Software Patcher utility. With it, when you get an upgrade of a device driver, you need only type `EZGen /d0 /os9boot`, link to `Cc3disk` and then type `u`, followed by a path list to the new driver. *EZGen* will pull out the old driver and put the new one in your boot file, making sure your boot file stays contiguous.

Burke & Burke also markets a utili-

THE BEST COCO ASSEMBLY LANGUAGE PROGRAMMING BOOKS IN PRINT

"Assembly Language Programming for the CoCo" (The Book) and the CoCo 3 (The Addendum). Professionally produced (not just skimpy technical specifications). THE CoCo reference books.

THE BOOK - 289 pages of teaching assembly language for the CoCo 1 & 2. It's used as a school text and is an intro to Computer Science. It describes the 6809E instructions, subroutines, interrupts, stacks, programming philosophy, and many examples. Also covered are PIAs, VDG, SAM, kybd, jystk, sound, serial port, and using cassette and disk. \$18.00 + \$1.50 s/h.

THE ADDENDUM - Picks up where the BOOK left off. Describes ALL the CoCo 3 enhancements & how to use them with assembly language. The most complete GIME spec. WOW - Super-Res Graphics, Virtual Memory, New Interrupts, and more information not available elsewhere. Find out what the CoCo 3 can really do. \$12.00 + \$1.00 s/h.

COCO 3 SPECIAL Start your CoCo library right. See what the CoCo can really do and save money - buy the BOOK and ADDENDUM for only \$27.00 + \$2.00 s/h.

US check or money order. RI orders add 6% sales tax

TEPCO
68 James Court
Portsmouth, RI 02871

See Us On DELPHI

ties disk that features Wild and Mv. Wild has a recursive option and can handle commands like wild -kp asm *.src o* or wild del c.temp*. Mv will move a directory entry from one point on the tree to another. When it runs, it moves the directory entry to a different directory, leaving the files in the same directory.

All Burke & Burke utilities are written in C, while all device drivers are written in assembly. Why does Chris Burke use OS-9? "Because like UNIX it's modular," he said. "When you add something, you don't need to learn a whole bunch of stuff over again. When you add a hard drive, it acts just like a floppy drive. Besides, it does multi-tasking and uses windows.

"The OS-9 windows are far better than MS-DOS windows because they are true multitasking windows," Burke said. "MS Windows is merely a 'kluge' on top of MS-DOS. Besides, if you time the Color Computer 3 running OS-9 Level II against an IBM XT, you'll find the CoCo is faster in most applications."

What does Burke see in the future for OS-9? "I think we need to get a lot of people writing OS-9 software. We need to get some good programs that will attract users. Once more users are attracted, more people will want to write programs. I think OS-9 has a really good future because it's a really good operating system. The 68K version is the standard for compact disk interaction, and someday there will be software running on OS-9 that is just as good as any running on MS-DOS."

Our Listing

This month we give you the framework of *Gfx3*. Feel free to tailor it to meet your desires. Once you type this subroutine package in and pack it, you can merge it with *Gfx2* and tap the functionality built into OS-9's WindInt manager interactively from within your BASIC09 programs — just like you use the graphics primitives with *Gfx2* now.

The day I started this month's column, I received an E-mail letter with *WizPro* attached from author Bill Brady. You won't believe your eyes. *WizPro* is not only the first 128K program for the Color Computer 3 — it's the first extendable communications program for the CoCo 3. Digest that thought for a while, and I'll be back to tell you more about this fantastic product next month. Until then, keep on hacking! □

The listing: Gfx3

```

PROCEDURE gfx3
0000      (* Add Basic09 functions to use WindInt functionality
0035      (* Syntax: run gfx3([path,]"Action",params)
0060
0061      PARAM path:BYTE
0068      PARAM action:STRING[12]
0074      PARAM one,two,three,four:INTEGER
0087
0088      TYPE Registers=cc,a,b,dp:BYTE; x,y,u:INTEGER
00AD      DIM Regs:Registers
00B6
00B7      DIM F_Icpt,F_Sleep:BYTE
00C2      DIM I_Getstt,SS_MnSel:BYTE
00CD      DIM I_SetStt,SS_MsSig,StdIn,SS_GIP,SS_Mouse:BYTE
00E4      DIM ss_sbar,ss_wnset,ss_umbar,gs_mouse:BYTE
00F7      DIM gs_opt,ss_ssig,ss_rel,ss_scsiz,gs_palt:BYTE
010E      DIM gs_kysns,ss_styp,ss_fbrg,ss_mtyp:BYTE
0121      DIM MouseSig,Follow:INTEGER
012C      DIM Grp_Ptr,Ptr_Arr:BYTE
0137
0138      Grp_Ptr=-202
013F      Ptr_Arr=-1
0146      F_Icpt=-$09
014E      F_Sleep=-$0A
0156      I_Getstt=-$8D
015E      I_SetStt=-$8E
0166      SS_MsSig=-$8A
016E      SS_MnSel=-$87
0176      SS_GIP=-$94
017E      SS_Mouse=-$89
0186      ss_sbar=-$88
018E      ss_wnset=-$86
0196      ss_umbar=-$95
019E      gs_opt=-$00
01A6      ss_ssig=-$1A
01AE      ss_rel=-$1B
01B6      ss_scsiz=-$26
01BE      gs_palt=-$91
01C6      gs_kysns=-$27
01CE      ss_styp=-$93
01D6      ss_fbrg=-$96
01DE      ss_mtyp=-$92
01E6      Follow=-1
01ED      MouseSig=-10
01F4
01F5      DIM EndStr:STRING[1]
0201      DIM Null,CallCode,FuncCode:BYTE
0210      Null=-0
0217      EndStr=-CHR$(Null)
0220      StdOut=-1 \StdIn=-0
022F
0230      (* End definitions
0242
0243
0244
0245      IF LEFT$(action,1)="_" THEN GOSUB 10000
0258          ON act GOSUB 1000,2000,3000,4000,5000,6000,7000,8000,9000
0284          END
0286      ENDIF
0288
0289      IF action="ss.sbar" THEN act=-100
02A3      ELSE IF action="ss.wnset" THEN act=-200
02C1          ELSE IF action="ss.umbar" THEN act=-300
02E0              ELSE IF action="ss.msel" THEN act=-400
02FF                  ELSE IF action="ss.msig" THEN act=-500
031D                      ELSE IF action="ss.mous" THEN act=-600
033B                          ELSE IF action="gs.mous" THEN act=-700
0359                              ELSE IF action="ss.gip" THEN act=-800
0376                                  ENDIF
0378                                      ENDIF
037A                                          ENDIF
037C                                              ENDIF
037E                                                  ENDIF

```



```

0380         ENDIF
0382     ENDIF
0384 ENDIF
0386
0387     ON act GOSUB 100,200,300,400,500,600,700,800
03AF     END
03B1
03B2 100  CallCode:=I_SetStt
03BD     Regs.a:=path
03C9     Regs.b:=ss_sbar
03D5     Regs.x:=one \(* contains horiz position
03FB     Regs.y:=two \(* contains vertical postion
0423     RETURN
0425
0426 200  CallCode:=I_SetStt \(* Set Status Code
0443     Regs.a:=path
044F     Regs.b:=ss_wnset
045B     Regs.x:=one \(* address of window structure
0485     Regs.y:=two \(* window type code
04A4     RUN SysCall(CallCode,Regs)
04B3     RETURN
04B5
04B6 300  CallCode:=I_SetStt \(* Set Status Code
04D3     Regs.a:=path
04DF     Regs.b:=ss_umbar
04EB     RETURN
04ED
04EE 400  Regs.a:=path
04FD     Regs.b:=SS_MnSel
0509     CallCode:=I_Getstt
0511     RUN SysCall(CallCode,Regs)
0520     one:=Regs.a \(* contains Menu ID Number
0545     two:=Regs.b \(* contains Menu Item Number
056C     RETURN
056E
056F 500  Regs.a:=path
057E     Regs.b:=SS_MsSig
058A     Regs.x:=one \(* contains requested signal code
05B7     CallCode:=I_SetStt
05BF     RUN SysCall(CallCode,Regs)
05CE     RETURN
05D0
05D1 600  Regs.a:=path
05E0     Regs.b:=SS_Mouse
05EC     Regs.x:=one \(* Update / timeout info
0610     Regs.y:=two \(* Follow=1, NoFollow=0
0633     CallCode:=I_SetStt
063B     RUN SysCall(CallCode,Regs)
064A     RETURN
064C
064D 700  Regs.a:=path
065C     Regs.b:=SS_Mouse
0668     Regs.x:=one \(* address of mouse packet
068E     CallCode:=I_Getstt
0696     RUN SysCall(CallCode,Regs)
06A5     one:=Regs.x \(* address of mouse packet
06CA     RETURN
06CC
06CD 800  Regs.a:=path
06DC     Regs.b:=SS_GIP
06E8     Regs.x:=one \(* Resolution, Port Location
0710     Regs.y:=two \(* Repeat start, repeat delay
0739     CallCode:=I_SetStt
0741     RUN SysCall(CallCode,Regs)
0750     RETURN
0752
0753 1000 CallCode:=I_Getstt
075E     Regs.a:=path
076A     Regs.b:=gs_opt
0776     Regs.x:=one \(* packet address of options
079E     RUN SysCall(CallCode,Regs)
07AD     RETURN
07AF
07B0 2000 CallCode:=I_SetStt
07BB     Regs.a:=path

```

Submitting Material To Rainbow

Contributions to THE RAINBOW are welcome from everyone. We like to run a variety of programs that are useful/helpful/fun for other CoCo owners.

WHAT TO WRITE: We are interested in what you may wish to tell our readers. We accept for consideration anything that is well-written and has a practical application for the Tandy Color Computer. If it interests you, it will probably interest lots of others. However, we vastly prefer articles with accompanying programs which can be entered and run. The more unique the idea, the more the appeal. We have a continuing need for short articles with short listings. These are especially appealing to our many beginners.

FORMAT: Program submissions must be on tape or disk, and it is best to make several saves, at least one of them in ASCII format. We're sorry, but we do not have time to key in programs and debug our typing errors. All programs should be supported by some editorial commentary explaining how the program works. We also prefer that editorial copy be included on the tape or disk using any of the word processors currently available for the Color Computer. Also, please include a double-spaced printout of your editorial material and program listing. Do not send text in all capital letters; use upper- and lowercase.

COMPENSATION: We do pay for submissions, based on a number of criteria. Those wishing remuneration should so state when making submissions.

For the benefit of those who wish more detailed information on making submissions, please send a self-addressed, stamped envelope (SASE) to: Submission Guidelines, THE RAINBOW, The Falsoft Building, P.O. Box 385, Prospect, KY 40059. We will send you comprehensive guidelines.

Please do not submit material currently submitted to another publication.

Protect and highlight your important magazine collection with sturdy RAINBOW binders



Distinctive, Durable RAINBOW Binders

THE RAINBOW is a vital resource to be referred to again and again. Keep your copies of THE RAINBOW safe in our quality, distinctive binders that provide complete protection.

These attractive red vinyl binders showcase your collection and ensure your RAINBOWS are in mint condition for future use. Each binder is richly embossed with the magazine's name in gold on the front and spine. They make a handsome addition to any room.

Put an End to Clutter

Organize your workspace with these tasteful binders. Spend more time with your CoCo and eliminate those frustrating searches for misplaced magazines.

A set of two binders, which holds a full 12 issues of THE RAINBOW, is only \$13.50 (plus \$2.50 shipping and handling).

Special Discounts on Past Issues

To help you complete your collection of THE RAINBOW, we're offering a special discount on past issues of the magazine.

When you place an order for six or more back issues of THE RAINBOW at the same time you order binders, you are entitled to \$1 off the regular back issue price. To order, please see the "Back Issue Information" page in this issue.

Know Where to Look

You may purchase the "Official And Compleat Index To THE RAINBOW" for \$1 when you purchase a set of binders. This comprehensive index of RAINBOW's first three years (July 1981 through July 1984) is usually priced at \$2.50.

For greater convenience, order RAINBOW Binders through the shopping area of the CoCo SIG of Delphi!

_____ YES. Please send me _____ set(s) of RAINBOW binders

Take advantage of these special offers with your binder purchase:

_____ Save \$1 off the single issue cover price for back issues. Minimum order of 6 magazines. Please enclose a back issue order form from a recent issue indicating magazines wanted.

_____ Purchase the "Official and Compleat Index to THE RAINBOW" for \$1. (Regular price \$2.50.)

(These offers good only with the purchase of a RAINBOW binder set)

Name _____

Address _____

City _____ State _____ ZIP _____

My check in the amount of _____ is enclosed. (In order to hold down costs, we do not bill.)

Charge to: VISA MasterCard American Express

Account Number _____ Expiration Date _____

Signature _____

Mail to: Rainbow Binders, The Falsoft Building, P.O. Box 385, Prospect, KY 40059.

Binders are \$13.50 per two-binder set plus \$2.50 shipping and handling. If your order is to be sent via U.S. mail to a post office box or foreign country, please add \$2. Kentucky residents add 5% sales tax. U.S. currency only, please. In order to hold down non-editorial costs, we do not bill.

For credit card orders call (800) 847-0309, 8 a.m. to 5 p.m. EST

All other inquiries call (502) 228-4492.

```

07C7     Regs.b:=ss_ssig
07D3     Regs.x:=one \(* contains requested signal code
0800     RUN SysCall(CallCode,Regs)
080F     RETURN
0811
0812 3000 CallCode:=I_SetStt
081D     Regs.a:=path
0829     Regs.b:=ss_rel
0835     RUN SysCall(CallCode,Regs)
0844     RETURN
0846
0847 4000 CallCode:=I_SetStt
0852     Regs.a:=path
085E     Regs.b:=ss_scsiz
086A     RUN SysCall(CallCode,Regs)
0879     one:=Regs.x \(* contains number of columns
08A1     two:=Regs.y \(* contains number of rows
08C6     RETURN
08C8
08C9 5000 CallCode:=I_Getstt
08D4     Regs.a:=path
08E0     Regs.b:=gs_palt
08EC     RUN SysCall(CallCode,Regs)
08FB     RETURN
08FD
08FE 6000 CallCode:=I_Getstt
0909     Regs.a:=path
0915     Regs.b:=gs_kysns
0921     RUN SysCall(CallCode,Regs)
0930     one:=Regs.a \(* contains keyboard scan info
0959     RETURN
095B
095C 7000 CallCode:=I_Getstt
0967     Regs.a:=path
0973     Regs.b:=ss_styp
097F     RUN SysCall(CallCode,Regs)
098E     one:=Regs.a \(* contains screen type code
09B5     RETURN
09B7
09B8 8000 CallCode:=I_Getstt
09C3     Regs.a:=path
09CF     Regs.b:=ss_fbrg
09DB     RUN SysCall(CallCode,Regs)
09EA     one:=Regs.a \(* contains foreground palette reg. no.
0A1C     two:=Regs.b \(* contains background palette reg. no.
0A4E     three:=Regs.x \(* least sig. byte of border palette no.
0A81     RETURN
0A83
0A84 9000 CallCode:=I_SetStt
0A8F     Regs.a:=path
0A9B     Regs.b:=ss_mtyp
0AA7     Regs.x:=one \(* contains monitor type
0ACB     RUN SysCall(CallCode,Regs)
0ADA     RETURN
0ADC
0ADD 10000 IF action="_gs_opt" THEN act:=1000
0AFB     ELSE IF action="_ss_ssig" THEN act:=2000
0B1A     ELSE IF action="_ss_rel" THEN act:=3000
0B38     ELSE IF action="_ss_scsiz" THEN act:=4000
0B58     ELSE IF action="_gs_palt" THEN act:=5000
0B77     ELSE IF action="_mgpb" THEN act:=6000
0B93     ELSE IF action="_styp" THEN act:=7000
0BAF     ELSE IF action="_fbrg" THEN act:=8000
0BCB     ELSE IF action="_mtyp" THEN act:=9000
0BE7     ENDIF
0BE9     ENDIF
0BEB     ENDIF
0BED     ENDIF
0BEF     ENDIF
0BF1     ENDIF
0BF3     ENDIF
0BF5     ENDIF
0BF7     ENDIF
0BF9     RETURN
0BF8

```

About Your Subscription

Your copy of THE RAINBOW is sent second class mail. You must notify us of a new address when you move. Notification should reach us no later than the 15th of the month prior to the month in which you change your address. Sorry, we cannot be responsible for sending another copy when you fail to notify us.

Your mailing label also shows an account number and the subscription expiration date. Please indicate this account number when renewing or corresponding with us. It will help us help you better and faster.

For Canadian and other non-U.S. subscribers, there may be a mailing address shown that is different from our editorial office address. Do not send any correspondence to that mailing address. Send it to our editorial offices at Falsoft, Inc., The Falsoft Building, P.O. Box 385, Prospect, KY 40059. This applies to everyone *except* those whose subscriptions are through our distributor in Australia.



Racksellers

The retail stores listed below carry **THE RAINBOW** on a regular basis and may have other products of interest to Tandy Color Computer users. We suggest you patronize those in your area.

ALABAMA

Birmingham Jefferson News Co.
Brewton McDowell Electronics
Florence Anderson News Co.
Greenville M & B Electronics
Madison Madson Books
Montgomery Trade 'N' Books
Tuscaloosa Injun John's, Inc.

ALASKA

Fairbanks Arrow Appliance/Radio Shack
Electronic World

ARIZONA

Cottonwood A & W Graphics Co.
Lake Havasu City Book Nook
Phoenix TRI-TEK Computers
Tempe Books, Etc.
Tucson Computer Library
Anderson News Co.

ARKANSAS

Fayetteville Vaughn Electronics/Radio Shack
Ft. Smith Hot Off the Press Newsstand
Little Rock Anderson News Co.

CALIFORNIA

Berkeley Lyon Enterprises
Citrus Heights Software Plus
Grass Valley Advance Radio, Inc.
Hollywood Levity Distributors
Stef-Jen, Inc.
La Jolla Butler & Mayes Booksellers
Los Angeles Circus of Books (2 Locations)
Marysville Bookland
Napa Bookends Bookstore
Oakland DeLauer's News Agency
Rancho Murietta Software Plus
Sacramento Delbert's Readerama
Tower Magazine
Booksmith
Bookworks
Castro Kiosk
San Francisco Midnight Special Bookstore
Computer Literacy Bookshops
Santa Monica Sawyer's News, Inc.
San Jose Harding Way News
Santa Rosa Paperbacks Unlimited
Stockton Computer Literacy
Sunnyvale El Camino College Bookstore
Torance

COLORADO

Aurora Aurora Newsstand
Colorado Hathaway's
Springs News Gallery
Denver The Book Train
Glenwood Springs Readmore Book & Magazine
Grand Junction City Newsstand
Longmont

DELAWARE

Middletown Delmar Co.
Newark Newark Newsstand
Wilmington Normar, Inc.—The Smoke Shop

DISTRICT OF COLUMBIA

Washington, DC Chronichles
News Room
World News, Inc.

FLORIDA

Boca Raton Great American Book Co.
Clearwater The Avid Reader
Cocoa The Open Door
Dania Dania News & Books
Davie Software Plus More
Ft. Lauderdale Bob's News & Book-Store
Clarks Out of Town News
Gainesville Mike's Electronics Distributor
Jacksonville Paper Chase
North Miami Book Co.
Beach Almar Bookstore
Panama City Boyd-Ebert Corp.
Pensacola Anderson News Co.
Pinellas Park Wolf's Newsstand
South Pasadena Poling Place Bookstore
Starke Record Junction, Inc.
Radio Shack Dealer
Sunny's at Sunset
Sunrise Anderson News Co.
Tallahassee DuBay's News Center
Titusville Computrac

GEORGIA

Atlanta Border's
Bremen Bremen Electronics/Radio Shack
Forest Park Eilers News Center
Jesup Radio Shack
Thomasville Smokehouse Newsstand
Toccoa Martin Music Radio Shack

IDAHO

Boise Book Shelf, Inc.
Moscow Johnson News Agency

ILLINOIS

Belleville Software or Systems
Champaign Bookmark
Chicago B. Dalton Booksellers
Decatur Book Emporium
K-Mart Plaza
Northgate Mall
Book Emporium
East Moline Norris Center Bookstore
Evanston Book Emporium
Kewanee Book Nook
Lisle Empire Periodicals
Newton Bill's TV Radio Shack
Paris Book Emporium
Peoria Book Emporium
Sheridan Village
Westlake Shopping Center
Springfield Illinois News Service
Book Emporium
Sangamon Center North
Town & Country Shopping Ctr.
Book Emporium
Sunnyland Paper Place
West Frankfort North Shore Distributors
Wheeling

INDIANA

Angola D & D Electronics
Radio Shack
Berne White Cottage Electronics
Book Corner
Bloomington Micro Computer Systems, Inc.
Columbus Koch's Books
Crawfordsville Miles Books
Dyer Gallery Book Shop
Franklin Michiana News Service
Ft. Wayne Finn News Agency, Inc.
Garrett Bookland, Inc.
Indianapolis Borders Bookshop
Delmar News
Indiana News
Southside News
Lebanon Gallery Book Shop
Martinsville Radio Shack
Richmond Voyles News Agency, Inc.
Wabash Mitting's Electronics

IOWA

Davenport Interstate Book Store
Des Moines Thackery's Books, Inc.
Fairfield Kramers Books & Gifts

KANSAS

Hutchinson Crossroads, Inc.
Topeka Palmer News, Inc.
Town Crier of Topeka, Inc.
Wellington Dandy's/Radio Shack Dealer
Wichita Lloyd's Radio

KENTUCKY

Hazard Daniel Boone Gulf Mart
Henderson Matt's News & Gifts
Hopkinsville Hobby Shop
Louisville Hawley-Cooke Booksellers (2 Locations)
Middletown Software City
Paducah Radio Shack

LOUISIANA

Baton Rouge City News Stand
Lockport TV Doctor/Radio Shack
New Orleans Sidney's News Stand Uptown
Monroe The Book Rack

MAINE

Bangor Magazines, Inc.
Brookton Voyager Bookstore
Caribou Radio Shack
Oxford Books-N-Things
Sanford Radio Shack

MARYLAND

College Park University Bookstore

MASSACHUSETTS

Boston Eastern Newsstand
Brookton Voyager Bookstore
Cambridge Out Of Town News

MASSACHUSETTS (cont'd)

Ipswich Ipswich News
Littleton Computer Plus
Lynn North Shore News Co.
Swansea Newsbreak, Inc.

MICHIGAN

Allen Park Book Nook, Inc.
Birmingham Border's Book Shop
Durand Robbins Electronics
E. Detroit Merit Book Center
Harrison Harrison Radio Shack
Hillsdale Electronics Express/Radio Shack
Holland Fris News Company
Lowell Lowell Electronics
Muskegon The Eight Bit Corner
Niles Michiana News Service
Perry Perry Computers
Riverview Riverview Book Store
Roseville New Horizons Book Shop

MINNESOTA

Burnsville Shinder's Burnsville
Crystal Shinder's Crystal Gallery
Edina Shinder's Leisure Lane
Minneapolis Shinder's (2 Locations)
Minnetonka Shinder's Ridge Square
Roseville Shinder's Roseville
St. Paul Shinder's Annex
Shinder's Maplewood
Shinder's St. Pauls
The Photo Shop
Willmar

MISSOURI

Farmington Ray's TV & Radio Shack
Flat River Ray's TV & Radio Shack
Florissant Book Brokers Unlimited
Jefferson City Cowley Distributing
Kirksville T&R Electronics
St. Louis Book Emporium
St. Robert Bailey's TV & Radio

MONTANA

Butte Plaza Books

NEBRASKA

Lincoln Nebraska Bookstore
Omaha Nelson News

NEVADA

Carson City Bookcellar
Las Vegas Hurley Electronics
Steve's Books & Magazines

NEW HAMPSHIRE

Keene Radio Shack Associate Store
Manchester Bookwrights
West Lebanon Verham News Corp.

NEW JERSEY

Atlantic City Atlantic City News Agency
Cedar Knolls Village Computer & Software
Clinton Micro World II
Pennsville Dave's Elect. Radio Shack
Rockaway Software Station

NEW MEXICO

Alamogordo New Horizons Computer Systems
Albuquerque Page One Newsstand
Santa Fe Downtown Subscription

NEW YORK

Amherst Village Green-Buffalo Books
Brookport Liff Bridge Book Shop, Inc.
Brooklyn Cramland, Inc.
Elmira Heights Southern Tier News Co., Inc.
Fredonia On Line Computer Access Center
Hudson Falls G.A. West & Co.
Huntington Oscar's Bookshop
Johnston Unicorn Electronics
New York Barnes & Noble—Sales Annex
Caliseum Books
Eastern Newsstand
Grand Central Station, Track 37
200 Park Ave., (Pan Am #1)
55 Water Street
World Trade Center #2
First Stop News
Idle Hours Bookstore
International Smoke Shop
Jonil Smoke
Penn Book
Software City
State News
Walden Books
World Wide Media Services
Universal Computer Service
Village Green
World Wide News
Pawling
Rochester

NORTH CAROLINA

Cary News Center in Cary Village
 Chapel Hill University News & Sundry
 Charlotte Newsstand Int'l
 Hickory C' Books & Comics
 Jacksonville Michele's, Inc.
 Kernersville K & S Newsstand
 Marion Boomers Rhythm Center
 Winston-Salem K & S Newsstand (3 Locations)
 Rainbow News Ltd.

OHIO

Akron Churchil News & Tobacco
 Canton Little Professor Book Center
 Chardon Thrasher Radio & TV
 Cincinnati Cinsoff
 Cleveland Erievue News
 Columbiana Fidelity Sound & Electronics
 Columbus B5 Software
 Micro Center
 The Newsstand

Dayton

Books & Co
 Huber Heights Book & Card
 Wilke News

Wright News & Books

Dublin**Fairborn**

Book Barn
 News-Readers
 Wilke's University Shoppe

Findley**Kent****Lakewood****Uma****Miamisburg****Parma****Toledo****Warren****Xenia****Youngstown**

Open Book
 The News Shop
 Lakewood International News

Edu-Caterers

Wilke News

Bookmark Newcenter

Leo's Book & Wine Shop

Book Nook, Inc.

Fine Print Books

Plaza Book & Smoke Shop

OKLAHOMA**Oklahoma****City****Talkequah****Tulsa**

Merrit Micro Software
 Thomas Sales, Inc. dba Radio Shack
 Steve's Book Store

OREGON**Eugene****Portland**

Libra Books — Book Mark
 Fifth Avenue News

Rich Cigar Store, Inc.

Sixth & Washington News

Capitol News Center

Checkmate Book

Salem**PENNSYLVANIA****Allentown****Altoona****Bryn Mawr****Cory****Danville****Easterville****King of Prussia****Malvern****Reading****Temple****West Chester****Wind Gap****York**

Owl Services
 Newborn Enterprises
 Bryn Mawr News
 Cory Books & Cards
 McIndoe's Stationery & Radio Shack
 Global Books
 Gene's Books
 Personal Software
 Smith's News & Card Center
 Software Corner
 Chester County Book Co.
 Micro World
 The Computer Center of York
 Tallgate Bookstore

RHODE ISLAND**Newport**

Bellevue News

SOUTH CAROLINA**Charleston Hts.****Clemson****Florence****Greenville****Spartanburg**

Software Haus, Inc.
 Clemson Newsstand
 Ray's #1
 Palmetto News Co.
 Software City

TENNESSEE**Brentwood****Chattanooga**

Bookworld #5
 Anderson News Co.

Guida Books & Periodicals

Highland Electronics

Anderson News Co

Davis-Kidd Bookseller

Computer Center

Davis-Kidd Booksellers

Mask's Place

R.M. Mills Bookstore

Dalke Electronics

Dickson**Knoxville****Memphis****Nashville****Smyrna****TEXAS****Big Spring****Desoto****Elgin****Harlingen**

Pancho's News
 Maxwell Books
 The Haming Pigeon
 Book Mall

UTAH**Provo**

Valley Book Center

VIRGINIA**Danville****Hampton****Norfolk**

K & S Newsstand
 Benders
 I-O Computers
 Turn The Page
 Volume 1 Bookstore

Richmond**WASHINGTON****Port Angeles****Seattle**

Port Book & News
 Adams News Co., Inc.
 Bulldog News
 B & I Magazines & Books
 Nyables 'N Bytes

Tacoma**WEST VIRGINIA****Huntington****Logan****Madison****Parkersburg****South****Charleston**

Nick's News
 Stan's Electronics & Radio Shack
 Communications, LTD
 Valley News Service

Spring Hill News

WISCONSIN**Appleton****Cudahy****Kenosha****Madison**

Badger Periodicals
 Cudahy News & Hobby
 R.K. News, Inc.
 Pic A Book
 University Bookstore
 JunEAU Village Reader
 Half Variety

Milwaukee**Waukesha****ARGENTINA****Cordoba**

Information Telecommunications

AUSTRALIA**Brisbane****Kingford**

Brian Computers
 Paris Radio Electronics

CANADA**ALBERTA****Banff****Bonnyville****Brooks****Calgary****Clareholm****Drayton Valley****Edmonton****Edson****Fairview****Fox Creek**

Banff Radio Shack
 Paul Terrier
 Double "D" A.S.C. Radio Shack
 Billy's News
 Radio Shack Associated Stores
 Langard Electronics
 CMD Micro
 Radio Shack, and
 D.N.R. Furniture & TV
 Fox City Color & Sound
 A.S.C. Radio Shack

H. Saskatchewan**Grande****Grande****Grande****Centre****Hinton****Innisfail****Lacombe****Leduc****Lethbridge****Lloydminster****Okotoks****Peace River**

H. Mall Radio Shack, ASC

The Stereo Hut

The Book Nook

Jim Cooper

L & S Stereo

Brian's Electronics

Radio Shack Associated Stores

Datalon

Lloyd Radio Shack

Okotoks Radio Shack

Radio Shack Associated Stores

Tavener Software

Waller's Electronics

Stettler Radio Shack

Wheatland Electronics

Pynewood Sight & Sound

Westlock Stereo

Radio Shack

BRITISH COLUMBIA**Burnaby****Burns Lake****Campbell****River****Chilliwack**

Compult

VI Video Works

TRS Electronics

Charles Parker

BRITISH COLUMBIA (cont'd)**Coquitlam****Coquitlam****Dawson Creek****Golden****Kelowna****Langley****Nelson****New West-****minster****Parksville****Penikese**

Cody Books LTD
 Rick's Music & Stereo
 Bell Radio & TV
 Taks Home Furnishings
 Telesoft Marketing
 Langley Radio Shack
 Oliver's Books

Cody Books LTD
 Parksville TV
 D.J.'s

Four Corner Grocery
 Sidney Electronics
 Wall's Home Furniture
 Kohk Electronics
 Active Components
 Friendlyware Computers
 Granville Book Co.
 Siliconconnections Books LTD

Sidney**Smithers****Squamish****Vancouver****100 Mile****House****MANITOBA****Altona****Lundar****Morden****The Pas****Selkirk****Virren****Winnipeg**

LA. Weber Ltd.
 Garanson Elec.
 Central Sound
 Jod's Sight & Sound
 G.L. Enns Elec.
 Archer Enterprises
 J & J Electronics Ltd.

Tip Top Radio & TV

NEW BRUNSWICK**Moncton****Sussex**

Jeffries Enterprises
 Dewitt Elec.

NEWFOUNDLAND**Bofwood****Carbonear**

Seaport Elec.
 Stude Realities

NOVA SCOTIA**Halifax**

Atlantic News

ONTARIO**Angus****Aurora****Concord****Exceter****Hanover****Huntsville****Kenora****Kingston****Listowel****South River**

Micro Computer Services
 Compu Vision
 Ingram Software
 J. Macleane & Sons
 Modern Appliance Centre
 Huntsville Elec.
 Donny "B"
 T.M. Computers
 Modern Appliance Centre
 Max TV
 Dennis TV
 Gordon and Gotch

Toronto**QUEBEC****LaSalle****Port. Rouge****Ville St. Gabriel**

Messageries de Presse Benjamin Err
 Boutique Bruno Laroche
 Gilles Comeau Err/Radio Shack

SASKATCHEWAN**Assiniboia****Estevan****Moose Jaw****Nipawan****Regina**

Teistar News
 Kohk Electronics
 D&S Computer Place
 Cornerstone Sound
 Regina CoCo Club
 Software Supermarket
 Everybody's Software Library
 Gec. Laberge Radio Shack
 Paul's Service
 Grant's House of Sound

Saskatoon**Shellbrooke****Tisdale****Unity****YUKON****Whitehorse**

H & O Holdings

JAPAN**Tokyo**

America Ado, Inc.

PUERTO RICO**San Juan**

Software City

Also available at all B. Dalton Booksellers, and selected Coles and W.H. Smith in Canada, Waldenbooks, Pickwick Books, Encore Books, Barnes & Noble, Little Professors, Tower Book & Records, Kroch's & Brentano's, and Community Newscenters.

Advertisers Index

We encourage you to patronize our advertisers — all of whom support the Tandy Color Computer. We will appreciate your mentioning THE RAINBOW when you contact these firms.

4-TECHS	129	Performance Peripherals	121	Second City Software	193
Adventure Novel	67	Perry Computers	111	SpectroSystems	75
After Five Software	143	Public Domain	73	SPORTSWARE	95
Alpha Products	21	PXE Computing	7	Sugar Software	164
Bob's Software	45	Rainbow Binder	188	Sundog Systems	27
Burke & Burke	161	Rainbowfest	50, 51	T & D Software	30, 31, 135
Cer-Comp	122, 123	Rainbow Introductory Guide to Statistics	74	Tandy/Radio Shack	BC
Cinsoft	39	Rainbow on Tape and Disk	52	Tepco	185
CoCo Cat Anti-Drug	12	RAM Electronics	81	Three C's Projects	169
CocoTech	41	RTB Software	129	True Data Products	174, 175
Codis Enterprises	81	Rulaford Research	149	Vidicom Corporation	177
Cognitec	29	Sardis Technologies	173	Wasatchware	49
Colorware	18, 19, 22, 23	SD Enterprises	25	Woodstown Electronics	39
Computer Center	93			Zebra Systems	65
Computer Island	69				
Computer Plus	3				
D.P. Johnson	179				
DATAMATCH, INC.	75				
Dayton Associates of W. R. Hall, Inc.	130, 131				
Delphi	118, 119				
Diecom	IFC				
Disto/CRC	113				
Dr. Preble's Programs	IBC				
E-Z Friendly Software	177				
Easy Street Data Systems	171				
Federal Hill	101				
FoxWare	95				
Frank Hogg Laboratory	46, 47				
GEnie	43				
Gimmesoft	61				
Granite Computer Systems	45				
Hard Drive Specialist	155				
Hawkes Research Services	101				
HawkSoft, Inc.	49				
Howard Medical	66, 94				
J & R Electronics	97				
Metric Industries	55				
Micro Works, The	63				
Microcom Software 9, 11, 13, 15, 17					
Microtech Consultants Inc.	181				
MicroWorld	57				
NRI Schools	99				
Owl-Ware	145, 146, 147				

 **Call:**
Belinda Kirby
Advertising Representative
 The Falsoft Building
 9509 U.S. Highway 42
 P.O. Box 385
 Prospect, KY 40059
(502) 228-4497

 **Call:**
Kim Vincent
Advertising Representative
 The Falsoft Building
 9509 U.S. Highway 42
 P.O. Box 385
 Prospect, KY 40059
(502) 228-4492

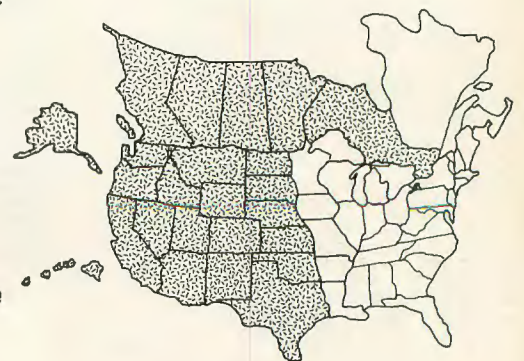

CoCo CALENDER

Organize all of your appointments with this 365 day CoCo Calender. 64k DISK.....\$9.95

BLACKJACK ROYALE

Even your casino odds with this BlackJack card simulation and tutor! Program can be edited for different 'house rules'. 64k DISK.....\$16.95

BSE - BASIC SCREEN EDITOR

Gives Basic a full-screen editor to supplement the regular EDIT commands. Works on the CoCo 1 2 and with the CoCo 3, width 32, 40 or 80 is supported! Complete screen cursor control with the arrow keys + features to make EDITing Basic programs a snap! BSE, a must have CoCo utility. Our low price was the only corner that was cut on this quality program. 64k DISK.....\$19.95

CHECK-09

Finally, a program that interacts with MultiVue for FAST and EASY check balancing. CHECK-09 and you can now take control of your bank checking account. No more waiting on your bank statement for an ending balance. CHECK-09 will provide a check-by-check balance in an easy to use format that eliminates those monthly surprises! Bring your money and you closer together and have the buck STOP HERE. 512K DISK w/MultiVue.....\$22.95

CoCoMAX II by Colorware

The 'CLASSIC' CoCo 1 & 2 graphic program. Draw great works of art with the program that set a standard for all others to follow. Supported by Hi-Res interface and numerous printer drivers for complete configuration. 64k DISK.....\$78.45

CoCoMAX III by Colorware

All new program based off the 'CLASSIC' CoCoMax II software. Allows for full animation, select 16 colors from a 64 color palette, fast & easy to use w/pull down menus in a point-and-click environment. 128k DISK.....\$78.45

CoCo KEYBOARD

Program allows the user to utilize the function keys on the HJL-57 Professional, Deluxe CoCo, and Micronix keyboard. 32k DISK.....\$6.95

TELEPATCH

Turn Telewriter 64 into the best Word Processor for the CoCo! TELEPATCH is compatible with all CoCo's. Comes with complete documentations for easy upgrading. 64k DISK.....\$24.95

HI-RES FONT MODIFIER

Create, modify, save and re-use as many CoCo 3 fonts that you can imagine. 128k DISK....\$14.95

COLOR MAX III FONT EDITOR

Allows you to custom create your own special ColorMax 3 fonts. Program and manual is easy to use for outstanding results! 128k DISK...\$19.95

SCHEMATIC DRAFTING PROCESSOR

A 'FAST' and 'EASY TO USE' ELECTRONIC DRAFTING PROCESSOR. Create pro-looking diagrams using a 480 x 540 pixel screen with 6 viewing windows! Over '30' electronic symbols with 10 definable symbols. Even supports Logic gates & Multipin chips! Print hardcopy or save to disk for later use. 64k DISK.....\$22.95

OS-9 SOLUTION

Tame the hostile environment of OS-9 with OS-9 SOLUTION! Replaces 20 of the command calls with single keystroke, menu driven commands. No more typing in long and complex pathnames or complicated syntaxes to remember! Works with either OS-9 Level One or Two.....\$24.95

TAPE/DISK UTILITY

A utility package that transfers TAPE to DISK or DISK to TAPE automatically. If you just got your first disk drive, TAPE/DISK is a MUST HAVE program. Will print tape & disk directories to any supported printer.....\$19.95

ADOS-3

The 'popular' ADOS-2 just got better with ADOS-3 SECOND CITY SOFTWARE special introductory price. 128k DISK.....\$32.95

FAST DUPE 2

Backup & Format as many copies of your original disk that you need. FAST DUPE 2 reads source into memory for fast and realible disk transfer Supports up to 4 disk drives! 64k DISK...\$19.95

MY-DOS by Chris Hawks

Supports accesses to double sided drives, able to use the J&M controller with the CoCo 3, DIR command simplified and a host of other special features. 64k DISK.....\$14.95

VIP LIBRARY

This popular 'integrated' package includes, VIP writer, Terminal, DataBase, Calc and Disk Zap which can fix a diskette with I/O errors. SCS special price. 64k DISK.....\$125.00

SOFTWARE SPOOLER & RAM DISK

Quick response or no disk swapping drive back-ups for 1 drive system and printer spooler to free computer during printing. For CoCo 3 with 512k DISK.....\$19.45

THE NEWSPAPER

Use your CoCo 3 for 'Desk Top Publishing'! The Newspaper is a complete & sophisticated program for creating Banners, Headlines & Text columns. Allows for importing different pictures, fonts & full patterns from disk for that professional look! Includes 22 fonts and 50 pictures. This one of a kind program has over 140k of program code! 128k DISK.....\$39.95

SECOND CITY SOFTWARE accepts Master Card, VISA C.O.D. and CHECK orders. Please add \$2.50 for shipping. Allow 2 to 4 weeks for delivery.



Second City Software
'your FIRST choice for CoCo software...'

P.O. Box 72956 Roselle, IL 60172
Order: 312-653-5610 BBS: 312-307-1519

HOWARD MEDICAL COMPUTERS

1690 N. Elston • Chicago, IL 60622 • ORDERS (800) 443-1444 • INQUIRIES AND ORDER STATUS (312) 278-1440

★ 5 STAR FINAL

AUGUST '88

CLEAR

HD-1 Sale Ends 9/3

DC-5 CONTROLLER

from Hard Drive Specialist gives great Radio Shack compatibility and double sided access to DSDD Drives like Howard's DD-3. Two ROM sockets, one 24 pin and one 28 pin allows use of RS 1.1 ROM by jumper selection. Gold plated contacts reduce I/O Errors. **\$75** (\$2 Shipping)



RS DOS ROM CHIP

ROM chip fits inside disk controller. 24 pin fits both J&M and RS controller Release 1.1 For CoCo 3 Compatibility. **\$25** each Reg. \$40 (\$2 shipping)

NEW FROM DISTO \$129 DC6 (\$2 Shipping) Super Controller II works with CoCo 1, 2 & 3. It buffers keyboard input so that no keystrokes

are lost when disk is reading or writing. Especially useful with OS-9, but also works with BASIC.

MONITOR

Sony KV-1311CR \$499

Regular \$625 (\$15 shipping)

- Vivid Color • Vertically flat 13" screen • Monitor/Trinitron TV with remote control • 640 × 240 resolution at 15MHZ .37 mm Dot pitch
- RGB analog & digital; TTL; and composite inputs • VCR inputs
- Cable to CoCo 3 \$36

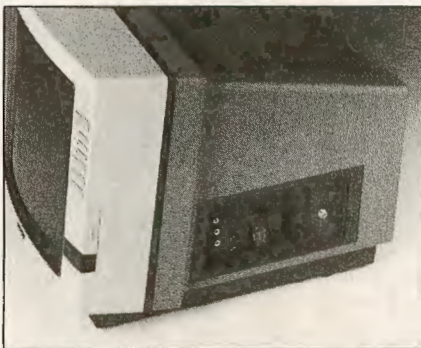

WORD PACK RS \$49

CoCo Max **\$78⁴⁵**

Basic Screen Editor **\$19⁹⁵**

MYDOS \$15

Payrol/BAS **\$29⁹⁵**

VIP Library **\$125**

VIP Writer **\$65**

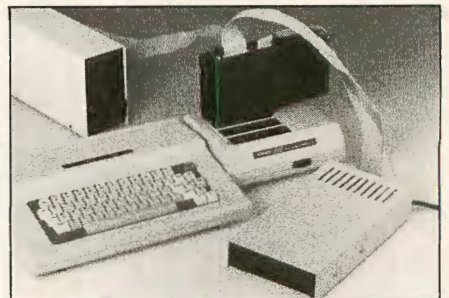

Hard Drive—Ready to Run!

20,000,000 Bytes or the equivalent to a 125 R.S. 501's on line are packed into this hard drive, pre installed and ready to run. All you need to do is plug it in and go! This complete easy to use package includes a Seagate 20 Meg Hard Drive, a Western Digital WD 1002-WX 1 Controller and interface that plugs into slot #3 of multipack interface, plus the case & power supply. You even get a 1 year warranty. This 20 meg Hard Drive will work with IBM & clone. Basic driver, \$49.95, lets you access this hard drive without need for OS-9. Howard's low price is aimed to get as many units as possible into the hands of "evaluators" to spread the word on it's quality.

HD-1 \$499 (\$9 Shipping)

Sale ends September 3

hotline number

DON'T MISS OUT, ORDER TODAY!

800 / 443-1444

WE ACCEPT VISA • MASTERCARD
• AMERICAN EXPRESS • C.O.D. OR
CHECKS • SCHOOL P.O.

"Guarantee" As good as Gold.

Howard Medical's 30-day guarantee is meant to eliminate the uncertainty of dealing with a company through the mail. Once you receive our hardware, try it out; test it for compatibility. If you're not happy with it for

any reason, return it in 30 days and we'll give you your money back (less shipping.) Shipping charges are for 48 states. APO, Canada and Puerto Rico orders are higher.

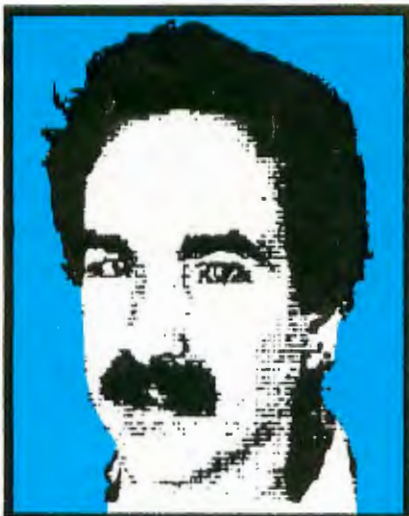

Dear Friends,

Thank you. 1988 marks our fifth year of providing quality software for the Color computer. Only your support has made it possible. So, from our hearts, Peg and I thank you. And remember our promise--if you buy it from us, we support it. If you are unhappy for any reason, send it back for a full refund within 30 days of purchase.

Pyramix

This fascinating CoCo 3 game continues to be one of our best sellers. Pyramix is 100% machine language written exclusively to take advantage of all the power in your 128K CoCo 3. The Colors are brilliant, the graphics sharp, the action fast. Written by Jordan Tsvetkoff and a product of Color-Venture.

The Freedom Series Vocal Freedom

I've got to admit, this is one nifty computer program. Vocal Freedom turns your computer into a digital voice or sound recorder. The optional **Hacker's Pac** lets you incorporate voices or sounds that you record into your own BASIC or ML programs. This is not a synthesizer. Sounds are digitized directly into computer memory so that voices or sound effects sound very natural. One "off-the-shelf" application for Vocal Freedom is an automatic message-minder. Record a message for your family into memory. Set Vocal Freedom on automatic. When Vocal Freedom "hears" any noise in the room, it

Dr. Preble's Programs



For Color Computer Software
Since 1983



plays the pre-recorded message! Disk operations are supported. VF also tests memory to take advantage of from 64K up to a full 512K. Requires low cost amplifier (RS cst. #277-1008) and any microphone.

Mental Freedom

Would your friends be impressed if your computer could read their minds? Mental Freedom uses the techniques of Biofeedback to control video game action on the screen. Telekinesis? Yes, you control the action with your thoughts and emotions. And, oh yes, it talks in a perfectly natural voice without using a speech synthesizer! Requires Radio Shack's low cost Biofeedback monitor, Cat. #63-675.

BASIC Freedom

Do you ever type in BASIC programs--manually, I mean. If you do, you know it can be a real chore. Basic Freedom changes all that. It gives you a full screen editor just like a word processor, but for BASIC programs. Once loaded in, it is always on-line. It hides invisibly until you call it forth with a single keypress! This program is a must for programmers or anyone who types in programs. By Chris Babcock and a product of Color-Venture.

Lightning Series

These three utilities give real power to your CoCo 3.

Ramdisk Lightning

This is the best Ramdisk available. It lets you have up to 4 mechanical disk drives and 2 Ram drives on-line and is fully compatible with our printer spooler below.

Printer Lightning

Load it and forget it--except for the versatility it gives you. Never wait for your printer again! Printer runs at high speed while you continue to work at the keyboard!

Backup Lightning

This utility requires 512K. Reads your master disk once and then

makes superfast multiple disk backups on all your drives! No need to format blank disks first! Supports 35, 40 or 80 track drives.

Prices

CoCo 3 only

Ram Disk Lightning Disk.....\$19.95
Printer Lightning Disk.....\$19.95
Backup Lightning Disk.....\$19.95
All three, Disk.....\$49.95
Pyramix, Disk.....\$24.95

CoCo 1,2, or 3

Vocal Freedom, Disk.....\$34.95
Vocal Freedom Hackers Pac..\$14.95

CoCo 2 or 3 only

Mental Freedom, Disk.....\$24.95
Basic Freedom, Disk.....\$24.95

CoCo 1 or 2 only

VDOS, The Undisk, ramdisk for the CoCo 1 or 2 only, Tape.....\$24.95
VDUMP, backup Undisk files to single tape file, Tape.....\$14.95
VPRINT, Print Undisk directory, Tape.....\$9.95

Everyone

Add \$2.50 shipping/handling in USA or CANADA

Add \$5.00 to ship to other countries

Dr. Preble's Programs
6540 Outer Loop
Louisville, KY 40228

24 Hour Hot Line
(502) 969-1818

Visa, MC, COD, Check



The Best in Color Computer Software

We've got the selection!

At Radio Shack, we're dedicated to making sure that you never run out of ways to use and enjoy your Color Computer. We've got a terrific line of software of all types.

Games for the whole family

Let your Color Computer open the door to a world of fun and adventure. Choose from a dazzling selection of popular and challenging games.

Make learning fun

One of the most valuable potentials of your Color Computer is in providing your children a head start in their education. We've got

learning programs for children of all ages that will provide hours of productive fun! With this selection, you'll find programs that help develop hundreds of useful skills.

Boost your productivity

No matter what your personal needs, we've got programs that'll put your Color Computer to work where you need it most—like personal filing, word processing, spreadsheets and communications.

Need more suggestions?

Send in the coupon for a free copy of our 1989 Software Reference Guide. Radio Shack is your one-stop software center.

Radio Shack®
The Technology Store™

A DIVISION OF TANDY CORPORATION

Send me a new 1989 Software Guide.

Mail to: Radio Shack, Dept. 89-A-318
300 One Tandy Center, Fort Worth, TX 76102

Name _____

Address _____

City _____

State _____

ZIP _____

Phone _____

