

Just For Your  
TRS-80® COLOR  
TDP System 100  
Dragon-32

# COCO PLOTS NUCLEAR FALLOUT!

Volume 2

Number 9

March, 1983

\$2.95

\$1.95 (U.K.)

# the RAINBOW

The Monthly Magazine For Color Computer Users

Printer Color Graphics

Chart Your Utility Bills

Guided Missile &  
Sub Hunt Games

Control Screen Output

64K Upgrade

Software and Hardware  
Reviews

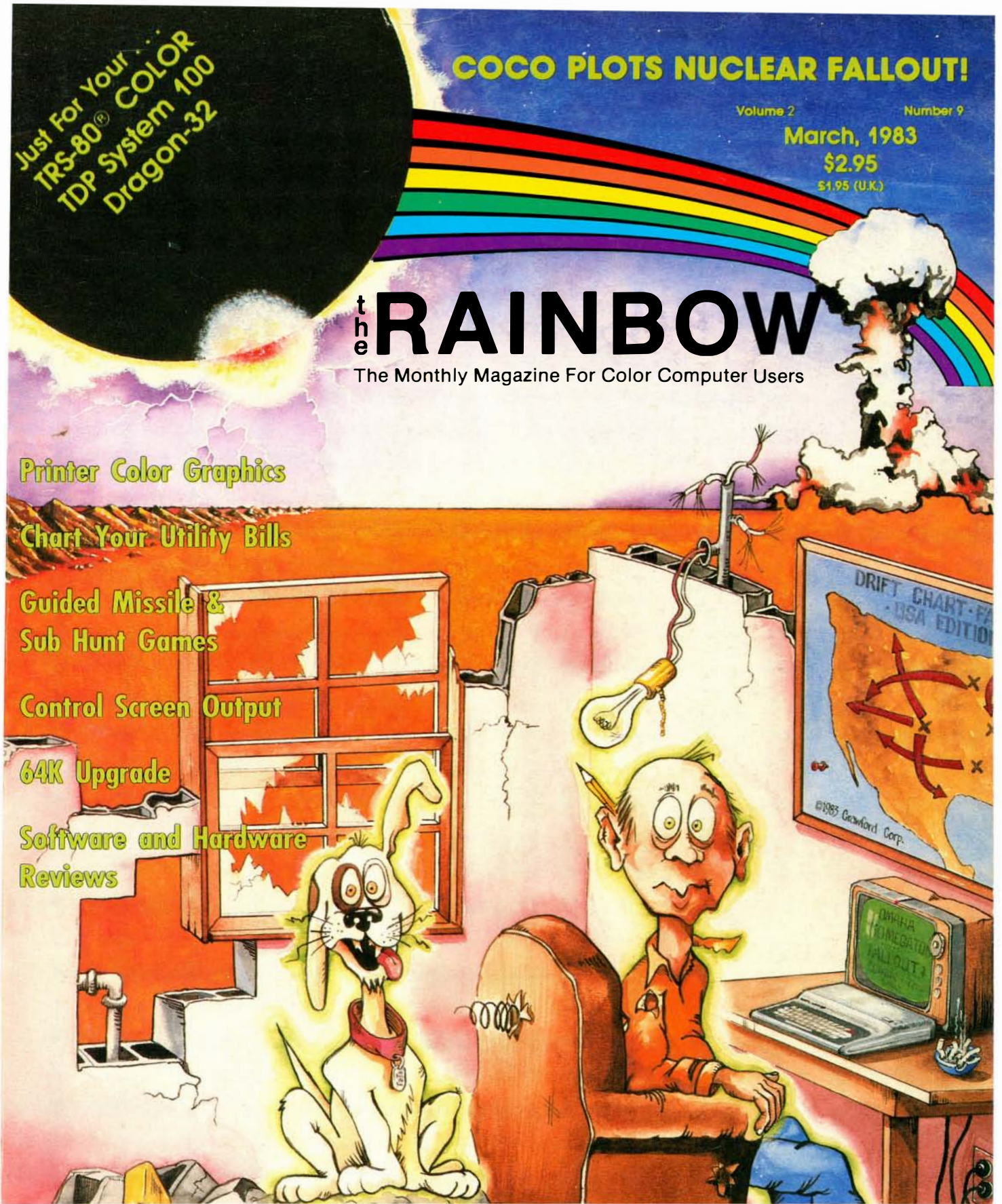

Bulk Rate  
U.S. Postage  
PAID  
Prospect, KY  
Permit No. 18



Address Correction Postage Requested

The RAINBOW  
P.O. Box 209  
9529 U.S. Highway 42  
Prospect, KY 40059



# Blast Off! Space Shuttle

WITH EXCITING NEW SPACE VIDEO

## REALISM IN FLIGHT!!

This program gives you the real feeling of flight. Full instrumentation complete to the max. Radar, altimeter, air speed, artificial horizon, fuel gauge, a mission status panel and many, many more to complete your flight control panel. **[Warning]**, this is not a game. This program is an actual simulation of spaceflight from blast off to landing. Also including variations in weather that must be considered.

**\$28.95** TAPE  
32K Extended Basic

## TOM MIX SOFTWARE

For the Color Computer and  
the TDP-100

3424 College N.E.,  
Grand Rapids, MI 49505



**(616) 364-4791**

## Take the Controls



and launch your shuttle  
for an incredible journey.

Add \$1.00 Postage & Handling

 Michigan Residents   
add 4% Sales Tax

Looking for new Software  
Top Royalties Paid

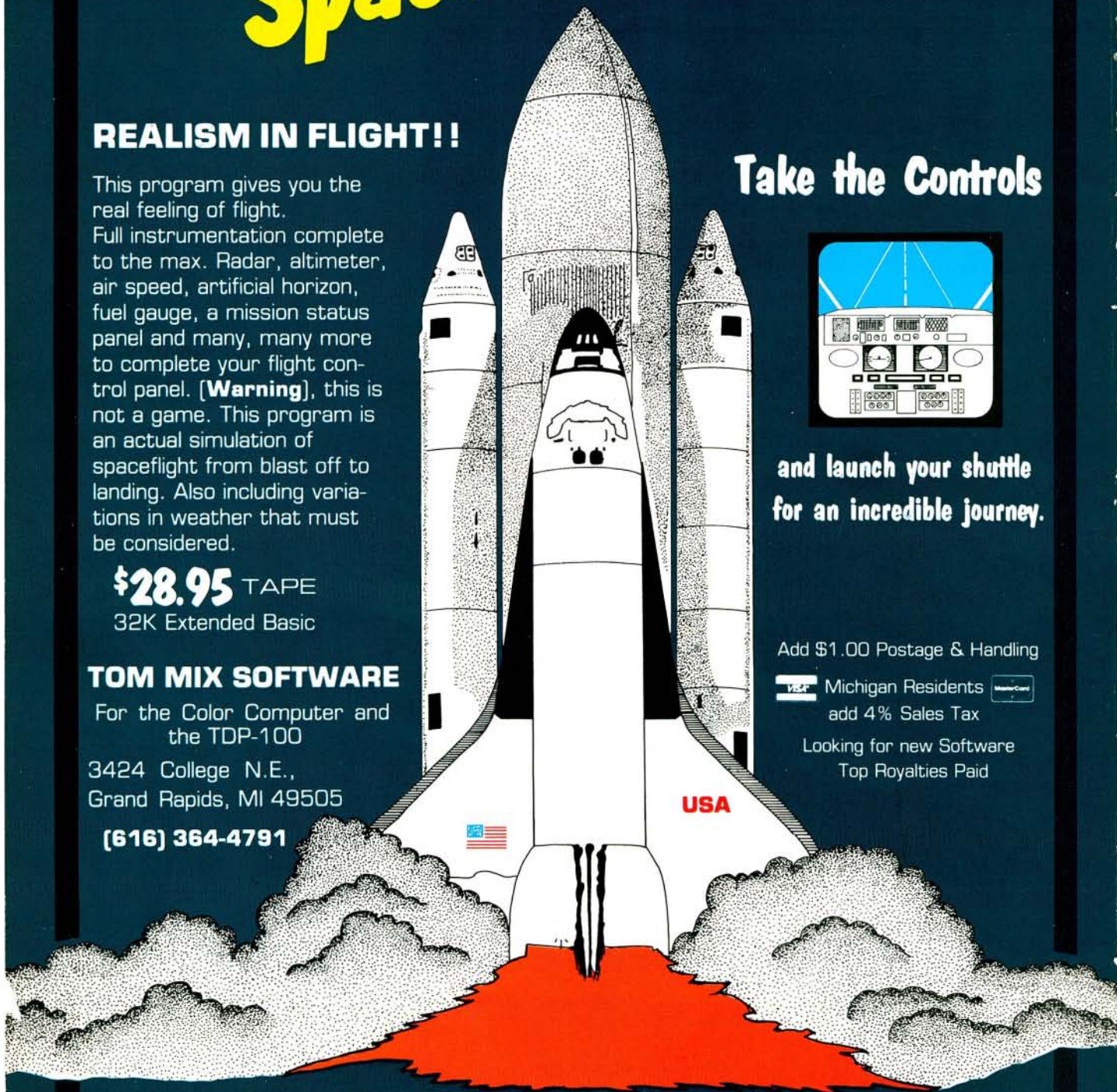



From Computer Plus to YOU...

# PLUS after PLUS after PLUS

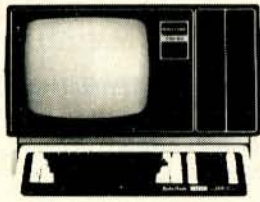

Model 16 128K  
1 Drive \$4199  
2 Drive \$4799



Color Computer 16K \$235  
w/16K Ext. Basic \$305  
w/32K Ext. Basic \$420



Model III 16K \$699  
Model III 48K  
2 Disk & RS232 c \$1549



Okidata 80 \$320  
Okidata 82A \$399  
Okidata 92 \$510

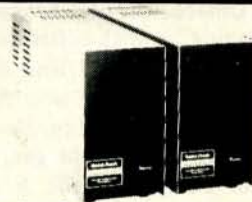

Color Computer Disk Drive  
Drive 0 \$470 Drive 1 \$299



Smith Corona TPI  
Daisy Wheel \$575

**BUY DIRECT** Here are just a few of our fine offers... call TOLL FREE for full information.

### COMPUTERS

Model 12 64K 1 Drive	\$2699
Model 12 64K 2 Drive	3375
Model III 4K LEV I	599
MODEL III 16K	699
MODEL III 48K	764
Model III 48K 2 Disk & RS232 c	1549
Color Computer 16K	235
Color Computer 16K w/extended basic	305
†Color Computer 32K-64K w/extended basic	420
Pocket Computer 2	230
Model 16 1DR 128K	4199
Model 16 2DR 128K	4799
DT-1 Data Terminal	599
PT-210 Portable Terminal	779

### MODEMS

Lynx Direct Connect MII/MIII	235
Hayes Smart Modem II	235
Hayes Smart Modem 1200	565
Novation Smartcat 1200	459

R.S. Acoustic Coupler AC-3	134
R.S. Modem I D.C.	130
R.S. Modem II D.C.	210
Signalman Modem	89

### PRINTERS

Daisy Wheel II	1715
DWP-410	1335
Smith Corona TPI Daisy Wheel	575
Epson MX80	499
Epson MX80 FT	549
Epson MX100	735
CGP-115	199
DMP-100	315
DMP-200	599
DMP-400	1029
DMP-500	1569
Okidata 80	320
Okidata 82A	399
Okidata 83A	655
Okidata 84 Parallel	999
Okidata 92	510
Okidata 93	859
P. C. Plotter Printer	199

### DISK DRIVES

R.S. Model III 1ST-Drive	650
Tandon 40 Track MI	289
Color Computer Drive 1	299
Color Computer Drive 0	470
Primary Hard Disk MII	3099
Primary Hard Disk MIII	1999

### ETC.

CCR-81 recorder	52
C. C Joysticks	22
16K RAM N.E.C. 200 N.S. chips	25
64K Ram Chips	75
Color Computer Flex D.O.S.	99
32K Microbuffer Inline	229

Brand Name Software •  
Send for listing.  
R.S. Software 10% off list

†Color Computer 64K requires  
Disk 0 and D.O.S.

Since 1973 —  
We have the lowest possible  
Fully Warranted Prices AND  
a full complement of Radio Shack  
Software.

Prices subject to change without notice.  
Not responsible for typographical errors.  
TRS-80 is a registered trademark of Tandy Corp.



**TOLL FREE  
1-800-343-8124**

# computer plus

P.O. Box 1094  
480 King Street  
Littleton, MA 01460  
617-486-3193

Write for your  
free catalog



# Under the Rainbow

## Feature Articles



40



64

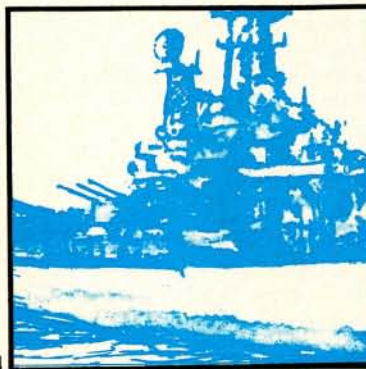

144

COVER watercolor by Fred Crawford.

- Color Printer Graphics/Dr. Lane P. Lester** ..... 18  
Now, colors on your printer, too!
- Furniture For The Classroom Computer/Dr. Paul Kimmelman** ..... 24  
Is this important topic a "forgotten" one?
- Two Illusions/D. and R. Delbourgo & Norman Latner** ..... 28  
Two programs—and three programmers—let CoCo view optical illusions.
- Half Life Of Nuclear Decay/ David Lengyel** ..... 34  
Let CoCo explain this oft-used, yet misunderstood process.
- Predicting Fallout/Dan Mickle** ..... 40  
Our feature program predicts fallout patterns and offers tips to avoid it.
- DOS Detach/Herbert Schroeder** ..... 54  
"Unplug" it with software.
- Power Of Attorney/Glenn B. Knight** ..... 56  
Can *The Rainbow* save you legal bills?
- Now HERE'S A Utility/Dennis H. Weide** ..... 64  
To keep track of the gas, light and water bills, that is.
- Control Your Screen/R. N. Roberts** ..... 84  
A special bonus for people with slow fingers.
- Analysis Of Variance/Sam Sherrill** ..... 94  
Looking at statistical difference of means.
- D-Board 64K Upgrade/B. H. Alsop** ..... 100  
With illustrations to boot.
- Consequences From Downunder/T. and R. Delbourgo** ..... 110  
Invite CoCo to the party.
- The Mercedes Of Disk Directories/Michael Plog** ..... 126  
Do it with real style!
- This One Is A Bomb/David A. Stewart** ..... 136  
And you have to deactivate it.
- Sub At 30 Fathoms!/Carl Shell** ..... 144  
*The Winds Of War* comes to your CoCo.
- Space Maurader At 20 Parsecs!/John Fraysee** ..... 154  
Work your way up to Commander In Chief.
- Smarts For A Dumb Terminal/Dan Downard** ..... 160  
Looking at an ML routine.
- Son Of Graphic Traffic/John Dana** ..... 164  
A colorful update.
- Low Resolution Drawing/Aaron Franksen** ..... 166  
For the 4K CoCo with joystick.
- What's A Monitor/Sue Seaby** ..... 174  
An examination of at this type program.
- A Rapid Logger For HAMs/B. B. Witham, Jr.** ..... 180  
For contest "heat."
- Circle Around, Folks/Karl Germann** ..... 191  
Going 'round and 'round.
- Spelling Practice/Ronald Pesha** ..... 198  
Help the cids, er...kids...spell.
- Check Your TV Alignment/David A. Cromley** ..... 201  
Just who is Roy G. Biv?



## Departments

Letters To Rainbow/Our Readers .....	6
PRINT #-2,/Lawrence C. Falk.....	8
Editor's Notes	
GameMaster's Apprentice/Bob Albrecht .....	12
Bones, subscripted variables and other things.	
Submission Guidelines .....	24
Using Graphics/Don Inman .....	102
Make and rotate rectangles.	
The PipelineStaff .....	122
Basic Training/Joseph Kolar .....	132
Creating a tape register	
Corrections.....	39, 140
Education Notes/Steve Blyn .....	152
Keeping track of incorrect answers.	
Back Issue Information .....	168
Turn Of The Screw/Tony DiStefano .....	176
Why not green on black display?	
Bits And Bytes Of Basic/Richard White.....	192
Keyboard input—it has many options.	
The Dragon's Byte/Bill Nolan .....	202
The finished character file.	
Assembly Corner/Dennis Lewandowski .....	218
What? More 'Vaders?	
Advertiser Index .....	226

## Product Reviews

Bigfoot .....	200	Minefield .....	124
CCthello .....	120	Ms. Nibbler.....	223
Clock .....	150	Nibbler.....	223
CoCo-Jot.....	114	Preread Package.....	172
Defense .....	142	Professional Keyboard .....	20
Double Stick Interface .....	199	Remoterm .....	170
Final Countdown/Paula Giese .....	90	Revolution.....	138
Frog Trek .....	197	Starship Hercules.....	81
Ghostmania .....	116	Stinger .....	134
Home Buyer's Analyzer .....	52	Stress Evaluator .....	190
Homebase/Frank J. Esser .....	36	Top Stix .....	199
Inspector Cluseau .....	173	Tower Of Fear .....	124
Match-It .....	82	Wall Street .....	20
Micro-Doc.....	150	Wormhole .....	216

**NEXT MONTH:** It is time to start thinking about entering our simulation contest—and we'll have a bang-up simulation for you to play...and from which you can get some ideas. Contest details, too.

Also, a really in-depth look at hex, a fine utility and a new column on your legal rights as a software buyer and/or author. And, another great game.

**PLUS . . .** A new edition of the Scoreboard, more programs, more tutorials, more information and more reviews on CoCo than anywhere else in the world! Don't miss April's *Rainbow!*

## The Rainbow

**Lawrence C. Falk**  
Editor

James E. Reed  
Managing Editor

Courtney Noe  
Associate Editor

Sally Nichols  
Art Director

Jerry McKiernan  
Assistant Art Director

Bob Albrecht  
Steve Blyn  
Don Inman  
Joseph Kolar  
Dennis Lewandowski  
Bill Nolan  
Charles Roslund  
Dick White  
Contributing Editors

Patty King  
Advertising Manager

**Patricia H. Hirsch**  
General Manager

Ivanka Kleier  
Customer Service Manager

Alice Showalter  
Bookkeeper

Monica Wheat  
Research Assistant

Wendy Falk  
Transportation

The **Rainbow** is published every month of the year by FALSOFT, INC., 9529 U.S. Highway 42, P.O. Box 209, Prospect, KY, 40059. Phone (502) 228-4492. **THE RAINBOW** and the Rainbow logotypes are ® Trademarks of FALSOFT, Inc.

Entire contents © by FALSOFT, Inc., 1983. **THE RAINBOW** is intended for the private use and pleasure of its subscribers and purchasers and reproduction by any means is prohibited. Use of information herein is for the single end use of purchasers and any other use is expressly prohibited. All programs herein are distributed in an "as is" basis, without warranty of any kind whatsoever.

TRS-80, Color Basic, Extended Color Basic, Scripsit and trademarks of the Tandy Corp. CompuServe is a ® Trademark of CompuServe Inc.

Subscriptions to **the RAINBOW** are \$22 year in the United States. Canadian and Mexican rates are U.S. \$29. Surface mail to other countries is U.S. \$39, air mail U.S. \$57. All subscriptions begin with the next available issue.

Limited back issues are available. Please see notice for issues which are in print and costs. Payment accepted by VISA, MasterCard, American Express, Cash, Check or Money Order in United States currency only.



# RAINBOW

## BECOMING A MUNK?

Editor:

In response to Jarrod Hollinghead's high score of 112,500 on *Dunkey Munkey*; I've got a 16 year old member (Kevin Hammerschmidt) of my congregation who scored 172,500 and quit because it was boring! I'm lucky if I break 70,000! Well, back to writing sermons on Telewriter...

Rev. Mike Jackson  
Dardenne Prairie, MO

**Editor's Note: We've gotten a lot of letters about scores—so, we've initiated a new feature this month, *Rainbow Scoreboard!* We invite your contributions to it for your scores in all the games available for CoCo.**

## KUDOS

Editor:

Having very recently purchased a Dragon-32, and surrounded myself with many magazines, I came across an advertisement for *the Rainbow* which is now available here in England. On reading *the Rainbow* I must admit that I went from a mildly interested computerist to a very keen trier and have subscribed for a regular supply.

I am adamant about "getting on top" of programming, but unfortunately at the moment I cannot carry out the minor adjustments necessary to make some of the TRS-80 programs run on my Dragon. Do you think you could include the minor adjustments in your future issues?

I.C. Hawksworth  
Derby, England

**Editor's Note: The English Edition, as opposed to the Edition in English, now carries adjustments for the Dragon. We felt this was necessary in order to take care of the minor changes.**

## WANTS A POSTER

Editor:

As I have said before, in my opinion, there is no other magazine comparable to yours. I receive several magazines each month, including *Science Digest*, *Peterson's Photographic*, and others of a technical nature. Of all of them, I look forward to receiving yours most of all. I enjoy the articles and the format is very well done.

In addition to being a high school science teacher, I am also a semi-professional photographer and framer. Needless to say, I had the poster in the January issue matted and framed and hung within 24 hours of receiving the issue in the mail. I think it was

great. Mr. Crawford is truly talented as an artist and January's cover readily confirms this.

Please poll your readers as to the interest in a poster of the January cover and any future poster quality covers. I'm sure there are many others like me who would love to collect images of this fast growing way of life.

I would also like to brag on one of your advertisers. Recently I ordered 24 tapes with boxes from *Micro 80*. In only a few short days, I received them. Due to no fault of theirs, eight of the boxes were broken during shipment. I called them and they told me to send them back for replacement. Not only did they replace the eight broken ones, they sent four more with them. Now, that's what I call *service*. It's nice to know there are still companies that believe in satisfying the customer.

Thank you again for the wonderful job you and your staff do each month.

Jimmie Bond  
Minden, LA

**Editor's Note: We've been thinking about offering the January cover as a poster, but the problem is we need some sort of minimum order. If others are interested in a poster at a cost of about \$5, please drop us a line.**

## TOM'S A WINNER, TOO

Editor:

I was very pleased to learn when I arrived home from vacation that my program *Escape From Sparta* was selected as a winner in your First Annual Adventure Contest. The following day I bought a copy of January's issue and was excited to see that it had won Best Science Fiction Trophy. I was, however, extremely disappointed to see that the name of Thomas Hollerback, co-writer of this adventure did not appear with my own. Without his help I could not have written *Escape From Sparta*. *Escape From Sparta* was a joint effort and intended to be a joint entry. Apparently, I may have misled you when I enclosed a separate letter in reference to the game signed only by myself. Tom's name appears along with my own in the program heading. Please give Tom the credit which he also deserves.

Rick Townsend  
Bettendorf, IA

## SIR GREGORY OF NEW YORK

Editor:

Thank you very much for the honor of having my program, *Sir Randolph of the Moors*, chosen to win first place in your recent non-graphics contest.

Until recently, I have been going it alone with my CoCo. Now I have a couple of friends interested, and I can talk "shop" with someone else besides my mirror.

I entered the contest not having any idea that I would even come close to a mention after the judging was completed. Thank you for giving me a large boost of incentive.

Gregory Clark  
Syracuse, NY

## OBJECTION

Editor:

These comments are to clarify statements made in the January 1983 review of *UP-1*. *UP-1* is designed as an aid to program development and not a peeker and poker. It allows programs to be stacked in memory until the memory is filled and has features for correcting defective programs.

The review stated that *UP-1* was written for a 4K machine. This is not true. Obviously more programs can be stacked in computers with larger memory. Programs can also be stacked in ROM Packs. It is true that the memory maps differ slightly for BASIC, Extended BASIC, and color disk systems. Before program stacking can be accomplished, the available free memory must be determined. Although Extended BASIC normally starts at 7681, programs can be stacked starting at 1537 if the extra graphic pages are not required. Programs can be stacked in disk systems starting around 4K. *UP-1* can be stacked with a defective disk program and *UP-1* used to correct the program.

*UP-1* is not intended to replace the EB Editor. Suppose statement 20 appears as 8223 between statements 10 and 30 in a program. The Extended BASIC Editor cannot correct this, but by using the memory scan feature of *UP-1*, this error can be spotted and corrected by poking the correct values into the erroneous statement number's vector location.

A machine language subroutine was added to *UP-1* which allows the operator to switch and run another program by entering *EXEC M* where M is the starting location of the subroutine. This updated program was sent to *the Rainbow* the first week in January.

Bill Chapple  
Dynamic Electronics, Inc.  
Hartselle, AL

## CLUBS, CLUBS, CLUBS

Editor:

I would like to introduce you and your readers to the Phoenix Color Computer Club. Our club is open to anyone and



everyone who expresses an interest in the Color Computer. Our meetings are held twice monthly on the first Tuesday and third Wednesday at the American Legion Post #1 located at 364 N. 7th Avenue, Phoenix. Interested persons may contact Mike Huffman, Secretary/Treasurer, at (602) 939-5666 or Tim Bremser, President, at (602) 939-2047 or Don Hendry, Vice-President, at (602) 386-5126.

*Mike Huffman  
Glendale, AZ*

**Editor:**

I'm interested in forming a CoCo group in the Fitchburg, Leominster, Lunenburg, Massachusetts area. If anyone is interested please write me, Jason Rahaim, Spring Street, Lunenburg, MA 01462.

*Jason Rahaim  
Lunenburg, MA*

**Editor:**

Please let it be known that the DC<sup>3</sup> (Dade County Color Computer Users Group) has started. Would you believe the only one in Dade County? For info call George McVay, (305) 274-8727.

*George McVay  
Miami, FL*

**Editor:**

The Medley Computer and Electronics Club has recently expanded to include representation by Color Computer owners. If interested please contact me (594-2755) or the President, Jamie Marriott, c/o MCEC, Canadian Forces Base, Cold Lake, Medley, AB, T0A 2M0.

*John Plaxton  
Medley, Alberta, Canada*

**Editor:**

We are a Color Computer club in north Broward County (Fort Lauderdale) Florida, with a sister club in Dade County. Address: 1040 S.W. 61st Avenue, Margate, FL 33068.

*Ernie Johnston  
Margate, FL*

**Editor:**

We are forming a Color Computer club in Memphis, and would like very much to hear from anyone interested in joining us. For further information, please contact me at 4903 Warrington Road, Memphis, TN 38118. Thanks.

*Ben Barton  
Memphis, TN*

**Editor:**

I would like to announce the formation of the Rockford Color Computer Club. For information write to me at 724 Irving, Rockford, IL 61103, or call 963-9187.

*John Picot  
Rockford, IL*

**Editor:**

I bought my Color Computer in June and discovered *the Rainbow* in August. It's difficult to say which I'm happier with. My wife—the computer widow—has another opinion, but she may become a convert yet.

I would like to either join, or start, a Color Computer User's group in the Utica-Mount Clemens-New Baltimore, MI area. Anyone

interested, please call me at 949-4842.

*John Herbert  
New Baltimore, MI*

**Editor:**

I would like to let you know that we have formed a club for Color Computer enthusiasts in Midland, MI. The club meets between 7 and 10 p.m. on the second Thursday of each month. Meetings are held in the lounge of the Grace A. Dow Library in Midland.

Further information may be obtained from:

Midland Color Computer Club  
c/o Neil Drake  
709 Coolidge  
Midland, MI 48640  
(517) 631-2939

We in the club enjoy reading *Rainbow* monthly. You and your staff are doing an excellent job. Please keep your quality publication coming our way.

*Neil Drake  
Midland, MI*

**Editor:**

There is a new club in the South Bay area of Los Angeles County. The address is:

South Bay Color Computer Club  
c/o Karen Schlotzhauer  
2545 W. 225th Place  
Torrence, CA 90505  
(213) 539-2539

I have been enjoying *Rainbow* for nearly a year. It keeps getting better and better. Keep it up.

*Karen Schlotzhauer  
Torrence, CA*

**Editor:**

You are invited to the next meeting of the Sea-Tac CoCo Club—the first Sunday of each month, from 1 p.m. to 3 p.m. Meetings are held at the offices of:

Counseling and Preventive Services  
Oakhurst Office Park—Suite 121  
1851 S. Central Place  
Kent, WA 98031  
854-7072

At the meetings, you can get acquainted with other owners, discuss software and hardware experiences, and see demonstrations of programs and equipment. A 32K Color Computer, cassette recorder, disk drive, printer, and TV will be provided by Dr. Nugent, the director of CAPS.

*Michael Nugent  
Kent, WA*

**Editor:**

I am trying to start a CoCo club in the Twin Lakes, Lake Geneva area here in Wisconsin. People can contact me (Dave Buehn) at 829 Hickory Road, Twin Lakes, WI 53181, or by calling me at (414) 877-2989.

*Dave Buehn  
Twin Lakes, WI*

## COCO COOKING

**Editor:**

When I'm finished with my computer in the evenings I drape a towel across it to keep out the dust. Wouldn't you know it, I left it on until the next day and when I removed the towel, it was cooking. But it still works like a champ. And they say need a fan in it...?

How about someone inventing a device that reads programs out of magazines and types them in your computer. My fingers are tired.

*Chris Barnak  
Suffolk, VA*

**Editor's Note: For aid to tired fingers, check page 174.**

## INFORMATION, PLEASE

**Editor:**

I am new to your magazine, and from purchasing just one issue I am already set on being a loyal reader from now on. I am the owner of a TRS-80 Color Computer and I have found more information in one issue of yours than I have seen in all my previous years as a TRS-80 owner. Your magazine has truly expanded my views on the capabilities of the CoCo. I recently upgraded my 16K computer to 32K and I would like to know if my computer is now capable of playing all 32K games and software. I thought perhaps I may have some RAM limitations being that it was originally a 16K computer. Keep up the excellent work, you're truly a remarkable magazine.

*Charles Mastrandrea  
Ann Arbor, MI*

**Editor's Note: No problem. You can use it for all 32K programs.**

**Editor:**

I have an Okidata 80 Printer using a Micro Works P180C parallel printer interface. What I want to know is what are the printer control characters and program for a screen dump for graphics to the Okidata 80 Printer.

Please write me at 4026 Danube Circle if you can help me with this.

*Willie Bethay  
Valdosta, GA*

## RECOMMENDED READING

**Editor:**

My thanks to Eugene Bouley of RI for his recommendation (in the November *Rainbow*) of *Programming the 6809* by Rodney Zaks and William Labiak. It's everything he claimed!

Let me recommend another great book for those who are really serious about assembly language on the CoCo. *The Facts* by Spectral Associates shows you where just about everything is in the CoCo and how to use it.

*Al Kalar  
Sumner, WA*



## HELPFUL HINTS

Editor:

I think these letter to the editor sections are great. I thought I would put my two cents worth in.

If you own the Chess ROM Pack and a black and white TV, you probably have noticed that both sets of pieces appear the same shade. Changing original memory location \$C0D1 to a \$F0 or \$F8 will remedy the problem.

I would like to see more information on disk drives.

Keep up the good work!

David Sweet  
Carmel, IN

Editor:

Playing *Dungeon Adventure* into the wee hours of the night, I was rapidly gaining confidence and had reached the 17th level. I had defeated spiders, demons, wizards and the like when I was surprised and destroyed by a tiny bug. In my fatigued state, during a battle I hit the "fight" key instead of the "move" key. There being no one to fight I was hopelessly trapped in an endless loop.

Undaunted, I resolved to rest and try again. The next night, I was rapidly jumping levels and apparently jumped past level 20. After continuing for some time, I was attacked by 68 demons. That was when I gave up and checked the listing for the winning level and found it to be "=20."

Both of the above require only minor fixes. To avoid the entry error in the fight sequence, add this line:

```
1395 IFK$=CHR$(32)THENGOSUB  
1440:GOTO1270
```

That will allow you to press the space bar if you have hit the "fight" key instead of the "move key" during the fighting sequence, and return to the options.

By changing line 1910 to read:

```
1910 IFAL(1)= 20THEN2280
```

the program will not continue endlessly if level 20 is passed. Nevertheless, congratulations to Gregory Ricketts for an excellent program and to *Rainbow* for their choice.

Pat Moss  
Corydon, IN

Editor:

In Joseph Kolar's article "Let's Take BASIC Training," he asked "Do you find that your manual flops around and is unwieldy and awkward to use, etc., etc.?" His solution was to purchase another manual to cut out the pages you are working on, and save your original manual for reference. Well, I came up with what I think is a better solution. I purchased a music stand to hold my books when I need to program from them. It has worked out super! I can adjust the height, and place the stand at just the right angle so as to eliminate that terrible neck pain you get from keeping your head and neck bent down looking at your work on the computer table.

Your *Rainbow* is F-a-n-t-a-s-t-i-c! Keep up the good work, and please keep those articles for us apprentices coming.

## PRINT #-2,

I am beginning to get really excited about RAINBOWfest—which is, after all, "CoCo's Very First Show!" As you will be able to see from information and registration material in *the Rainbow*, it is to be in Chicago, April 22-24, at the Regency-Hyatt Woodfield.

RAINBOWfest is going to be an all-purpose show—not just a trade exhibition. Yes, there will be a lot of displays with people and products. And most of the biggest names in the CoCo world will be on hand. You will see new products, learn some new things and have a chance to talk with other CoCoists from all over the country. We know of several groups planning to charter buses for the trip.

But there is to be more to RAINBOWfest! One of the biggest things will be a series of seminars and a breakfast talk. We have tentatively scheduled Don Inman to be the breakfast speaker. And, as you know, Don is the acknowledged master of computer graphics for the CoCo. This breakfast is open to everyone, so we hope you'll make plans to attend.



Then, too, the seminars will be run most of the day Saturday, and on Sunday as well. All the speakers and topics are not firm yet, but we will be covering everything from Basic hints to machine language animation, from the legal rights you have as a buyer of software to setting up and communicating with bulletin boards. Also: A special session is planned for officers of Color Computer clubs.

All in all, we hope RAINBOWfest will be a great weekend for anyone and everyone interested in CoCo—on all levels, from beginner to advanced programmer. If you can possibly make it, we hope to see you there.

I would like to thank everyone who has taken the time to write in about the changes we have been making to *the Rainbow*. The one which has, obviously, received the most attention is the "slick" paper. At this point, the positive comments are running well ahead of the negative ones—but there are a number of you who have expressed unhappiness with

the new paper.

Those of you who are pleased with the "crisp," "neat," "professional" new look of our magazine will be pleased to know that, at least for now, we are keeping the "slick" paper. But, for those of you who have expressed unhappiness, you, too, will be pleased to learn that we are making a slight change soon that we hope will solve the most-mentioned problem—that of glare. We've found another "slick" paper which has a slight bluish cast to it (it is hard to tell unless the two papers are held up side-to-side). This paper will still give us the same "slick" look, but should be a little easier on the eyes. As always, we will appreciate your comments.

And, I suppose while commenting on the magazine in general, this is as good a place as any to welcome Jerry McKiernan to our staff. Sally Nichols, our art director, needed some help and Jerry is providing that as Assistant Art Director. Incidentally, Jerry's a whiz at what I call "dot art"—and I'm sure you'll be able to pick out some of his illustrations in this month's issue.

I would also like to welcome Patty King as our first advertising and special events manager. In addition to getting the advertising section in shape, Patty will be responsible for RAINBOWfest planning—and working with Dave Hooper, who is the local arrangements chairman in Chicago. Patty is very qualified to work on a project like this—she was responsible for all the planning of the U.S. Conference of Mayors in Louisville a couple of years ago.

One of the things which has happened this past month is a couple of letters flying back and forth from various people concerning a letter which appeared in the *Bouquets And Brickbats* section of last month's *Rainbow* about a product.

One of the letters was from Thomas Cassidy of Ozone Park, N. Y., in defense

(Continued on Page 188)



# ENTER INTO THE NEWEST DIMENSION FOR THE COLOR COMPUTER AND TDP-100

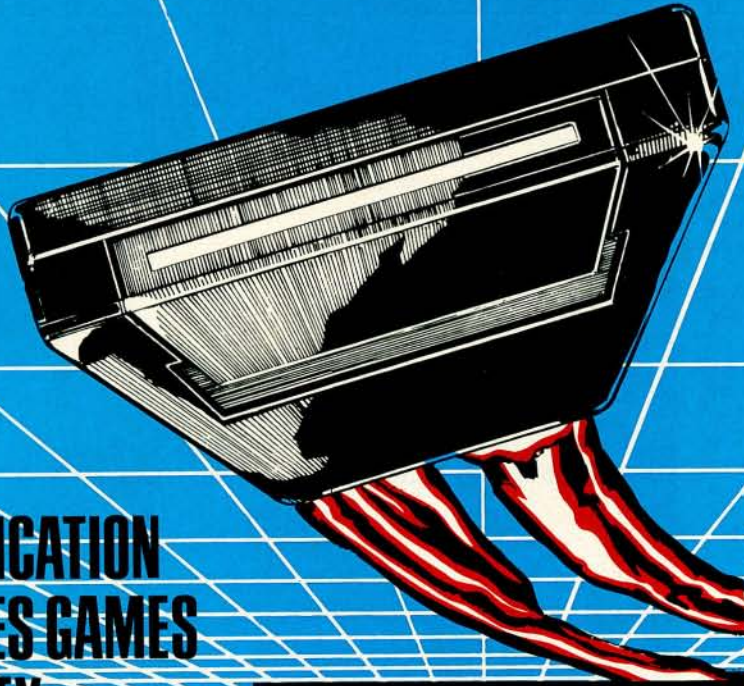

**APPLICATION**  
**HI-RES GAMES**  
**UTILITY**  
**EXPERIMENT**  
**2-K**  
**4-K**  
**8-K**  
**16-K**  
**KITS**



## ROM PAC

### PUBLISHERS

Anteco will put your programs in professional, convenient ROM PAC form.

### DEALERS

Specify Anteco ROM PACs when you order from your favorite publisher

### ENGINEERS

If you are writing or designing ROM PORT software, look to Anteco for a ROM PAC kit to "professionalize" your work.

Call or write  
**ANTECO** 4220 Clay Ave.  
Fort Worth, Texas 76117  
1-800-433-7631

**ANTECO**  
division of  
Antenna Electronics Co.

*Footlocker*



Long live the CoCo.

Pat Thompson  
Union, OR

**Editor:**

When anyone starts to learn/use Assembly Language for the 80C he/she will soon run up against the terrible lack of instructions on how to enter a line of Assembly code. This is a simple stage, almost a simple-minded one, but it is essential and the lack of it can stop a learner of Machine Language cold. In the book *Assembly Language Graphics for the TRS-80 Color Computer* by Don Inman and Kurt Inman, the very simple first stages of data entry are spelled out, explained, and illustrated starting on page 49. Working through this book would be a good idea whether or not one wants to use Machine Language/Assembly Language graphics on the 80C computer.

Paulette Grantham  
Palo Alto, CA

**Editor:**

In reply to Doug Tooms' letter (January), *Ghost Gobbler* produces its sound by storing data at location \$FF20 very quickly, as most machine language games do. The printer port also uses this location as an output to the printer. So, when sound is produced, data (which comes out as garbage) goes to the printer. The reason that this garbage is only printed every once in a while, is that the printer's buffer buffers the garbage.

Here's something else that is not in the documentation. When *Ghost Gobbler* asks for your name, pressing SHIFT@ causes the computer to go into high speed (providing, of course, that your CoCo works with the "high-speed POKE").

To Jorge Mir who wanted to move his string space to the extra 8K of his 64K system: Try POKEing the highest address of your extra memory (which I believe is \$FEFF) into the low memory locations \$27/28. Be careful not to use more than 8K of strings or you might run over Disk BASIC.

POKE &H27, &HFE : POKE &H28,  
&HFF

Now, I have a question. How is SLENB\* (on the cartridge connector) utilized?

Kyle Rogers  
Knoxville, TN

### JUMPING DOWN

**Editor:**

We have just become acquainted with your magazine—having the November and December issues. Find them great!

I keyed in *Parachute Jump* from the December issue and now have a battle on my hands. Our son (11 years old) has beaten his father's score and, of course, that can't go unchallenged. I think they play it just to see the lightning bolt and to hear the tune being played as the poor chutist drops to ground after the bomb gets him. But then I could be wrong.

Betty Cutler  
Clifford, Ontario, Canada

# RAINBOW SCOREBOARD

Do you recall Jarrod Hollinghead's letter to the Editor a few months ago referring to his *Dunkey Munkey* score, asking if anyone had done better?

Well, we've gotten a number of letters from readers as a result of Jarrod's initial inquiry, and thought we might develop this interest into a regular

feature devoted to listing the high scores of readers for any game for the 80C that registers players scores.

So, let us hear from you. Whatever the game—send us your high score along with your name, city and state and we'll publish it right here in our *Rainbow* Scoreboard column.

GAME	SCORE	PLAYER
Dunkey Munkey	1,099,400	Andrew Herron, High Point, NC
Dunkey Munkey	1,000,500	Wendy Johnson, San Jose, CA
Dunkey Munkey	311,500	Sara Hennessey, Golden Vally, MN
Dunkey Munkey	304,000	Mike Wells (11), Pittsburgh, PA
Dunkey Munkey	300,000	Cameron Amick, Reisterstown, MD
Dunkey Munkey	293,300	Kim Cook, High Point, NC
Dunkey Munkey	251,200	Todd Bernhard, Rochester, NY
Dunkey Munkey	250,000	Dave Roper, Lambertville, MI
Dunkey Munkey	172,500	Mike Jackson, Dardenne Prairie, MO
Dunkey Munkey	144,900	Aaron Findley, Sierra Madre, CA
Scarfman	388,060	Michelle Thompson, Milpitas, MS
Ghost Gobbler	825,250	Randy Gerber, Wilmette, IL

Cameron Amick obviously spends a great deal of his computer time as a gamer, and since he has gone to the additional trouble of logging his scores and mailing them to us, we thought we would print them. His *Dunkey Munkey* score of 300,000 points lands him in fifth place on this month's Scoreboard for that game. As his other scores are uncontested, we suppose that gives him

at least a temporary first place in those game categories. This is a distinction shared by Michelle Thompson and Randy Gerber, whose uncontested scores for *Scarfman* and *Ghost Gobbler*, respectively, make them gamers without peer.

Here is the summation of Cameron's considerable efforts.

Astro Blast (Mark Data)	63,000
Avenger (Cornsoft Group)	5,000
Colorpede (Intracolor)	245,723
Color Haywire (Mark Data)	9,150
Color Meteoroids (Spectral Associates)	149,000
Color Invaders (Spetral Associates)	83,000
Colour Pac Attack (Computerware)	193,000
Donkey King (Tom Mix)	115,600
Dunkey Munkey (Intellectronics)	300,000
Katerpillar Attack (Tom Mix)	10,249
Mega-Bug (Radio Shack)	6,211
Pacet Man (American Sm. Comp.)	5,000
Polaris (Radio Shack)	36,000
Pop Corn (Radio Shack)	110,570
Protectors (Tom Mix)	358,514
Skiing (Radio Shack)	1:13.25
Space Assault (Radio Shack)	28,850
Sky-Defense (Quasar Animations)	5,200
Storm (Computerware)	380,000
Starship Chameleon (Computerware)	168,500
Starfire (Intellectronics)	464,700





Fly your spaceship through enemy Starbases. Avoid guided missiles, lasers, and firing turrets! Can you reach their leader... ZAKSUND?

★ 3-D ★  
**COLOR GRAPHICS**

... the creators of  
 - Intergalactic Force<sup>1</sup>  
 - War Kings<sup>2</sup>  
 - Party Pak<sup>1</sup>  
 - Trek-16<sup>2</sup>  
 - many other fine programs!

1. ANTECO  
 2. TOM MIX

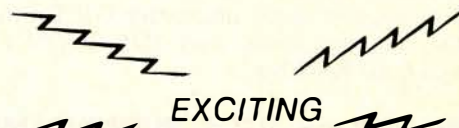

**Elite Software**

Box 11224  
 Pittsburgh, PA 15238  
 (412) 795-8492

**\$24.95** Casette  
**\$27.95** Disk

Add \$1 Postage and Handling  
 PA residents add 6% sales tax

ARCAD ★ ACTION  
 ★ ★ ★ ★ ★  
 32K  
**MACHINE LANGUAGE**



# Roll Those Bones (And Other Characteristics)

By Bob Albrecht and George Firedrake  
*Rainbow* Contributing Editors

Last time, we showed you three short programs to "roll" the seven basic characteristics for a fantasy role playing character. Here is one of the programs.

```

_100 REM ** CREATE A CHARACTER
199 :
300 REM ** CLEAR THE SCREEN
310 CLS
320 RESTORE
399 :
500 REM ** ROLL & PRINT CHARACTE
RISTICS
510 READ CHAR$
520 IF CHAR$ = "ZZZ" THEN 710
530 GOSUB 910
540 PRINT CHAR$, DICE
550 GOTO 510
560 DATA STR, CON, SIZ, INT
570 DATA POW, DEX, CHA, ZZZ
599 :
700 REM ** TELL HOW TO DO AGAIN
710 PRINT
720 PRINT "TO DO AGAIN, PRESS AN
Y KEY"
730 IF INKEY$ = "" THEN 730 ELSE
310
799 :
900 REM ** DICE SUBROUTINE
910 D1 = RND(6)
920 D2 = RND(6)
930 D3 = RND(6)
940 DICE = D1 + D2 + D3
950 RETURN
    
```

Our program rolls a number from three to 18 for each and every characteristic. Alas, a character with SIZ 15, STR 3, and DEX 5 will never make it in the GameMaster's world. So, we suggest some alternative DICE subroutines.

Our first variation. Roll 3D6. If DICE is less than 6, assign 6 as the value.

```

900 REM ** DICE SUBROUTINE
910 D1 = RND(6)
920 D2 = RND(6)
930 D3 = RND(6)
940 DICE = D1 + D2 + D3
950 IF DICE < 6 THEN DICE = 6
960 RETURN
    
```



Our second variation: A more generous GM says, "If DICE is less than 6, add 3 to the value of DICE."

```

900 REM ** DICE SUBROUTINE
910 D1 = RND(6)
920 D2 = RND(6)
930 D3 = RND(6)
940 DICE = D1 + D2 + D3
950 IF DICE < 6 THEN DICE = DICE + 3
960 RETURN
    
```



We hear some GMs allow players to roll 4D6 and take the best three. If you roll



you can discard



and take



for a total of 13

Hmmm...we get the same result if we add all four dice and subtract the smallest. Here is our first attempt.

```

900 REM ** DICE SUBROUTINE
910 D1 = RND(6)
920 D2 = RND(6)
930 D3 = RND(6)
940 D4 = RND(6)
950 SMALL = 7
960 IF D1 < SMALL THEN SMALL = D1
970 IF D2 < SMALL THEN SMALL = D2
980 IF D3 < SMALL THEN SMALL = D3
990 IF D4 < SMALL THEN SMALL = D4
1000 DICE = D1 + D2 + D3 + D4 - SMALL
1010 RETURN
    
```

Here is another way, using subscripted variables.

```

900 REM ** DICE SUBROUTINE
910 FOR KK = 1 TO 4
920 : D(KK) = RND(6)
930 NEXT KK
940 SMALL = 7
950 FOR KK = 1 TO 4
    
```



```

960 : IF D(KK)<SMALL THEN SMALL=
D(KK)
970 NEXT KK
980 DICE=D(1)+D(2)+D(3)+D(4)-SMALL
990 RETURN

```

We suggest a third way for you to try. Write lines 910 through 930 as we did above, putting the four dice values in D(1), D(2), D(3), and D(4). Next, *sort* these values so the *smallest* value is in D(4) and the other three values are in D(1), D(2), and D(3). Finally, compute: DICE = D(1) + D(2) + D(3).

Our program rolls seven basic characteristics for a *Worlds of Wonder* or *Runequest* character. For a *Dungeons & Dragons* or *Tunnels & Trolls* character, change only lines 560 and 570.

D&D Character: 560 DATA STR, INT, WIS  
570 DATA DEX, CON, CHR, ZZZ

T&T Character: 560 DATA STR, CON, IQ  
570 DATA LK, DEX, CHR, ZZZ

#### A SMALL CAST OF CHARACTERS

We have begun a cast of characters. Below are their names and characteristics.

	STR	CON	SIZ	INT	POW	DEX	CHA
Aloysious	10	11	10	12	10	12	9
Barostan	17	17	13	8	7	15	6
Bridla	11	12	10	15	6	11	16
Dernfara	13	13	8	13	4	17	6
Joleen	13	11	7	13	8	17	13
Rokana	9	9	9	17	18	9	10

Here is a simple information retrieval program. Information about our characters is stored in *DATA* statements. If you type in the name of one of these characters, the computer will find the information and display it on the screen.

```

100 REM ** CHARACTER FINDER
199 :
200 REM ** WHO$ IS CHARACTER
210 CLS
220 INPUT "NAME OF CHARACTER"; WHO$
299 :
300 REM ** START AT BEGINNING OF
DATA FILE
310 RESTORE
399 :
400 REM ** READ RECORD. EOF?
410 READ NAME$
420 READ STR, CON, SIZ, INQ, POW
, DEX, CHA
430 IF NAME$="ENDFILE" THEN 810
ELSE 510
499 :
500 REM ** IS IT OUR CHARACTER?
510 IF NAME$=WHO$ THEN 610 ELSE
410

```

```

599 :
600 REM ** FOUND OUR CHARACTER
610 PRINT
620 PRINT "STR", STR
630 PRINT "CON", CON
640 PRINT "SIZ", SIZ
650 PRINT "INT", INQ
660 PRINT "POW", POW
670 PRINT "DEX", DEX
680 PRINT "CHA", CHA
699 :
700 REM ** TELL HOW TO DO AGAIN
710 PRINT
720 PRINT "TO DO AGAIN, PRESS AN
Y KEY"
730 IF INKEY$ = "" THEN 730 ELSE
210
799 :
800 REM ** OOPS! NOT IN FILE
810 PRINT "I DON'T KNOW " WHO$
820 PRINT "TO DO AGAIN, PRESS AN
Y KEY"
830 IF INKEY$ = "" THEN 830 ELSE
210
899 :
1000 REM ** DATA FILE
1010 DATA ALOYSIUS, 10, 11, 10,
12, 10, 12, 9
1020 DATA BAROSTAN, 17, 17, 13,

```

We use INQ because INT is a reserved word.



**NEW** ADVANCED MATH PROGRAMS  
for  
ENGINEERS • PHYSICISTS • STUDENTS

**FUNCTION GRAPHING MODULE 16K EXT-\$19.95**

- \* HIGH RESOLUTION GRAPHS
- \* GRAPH ANY FUNCTION — 4 AT ONCE
- \* PARAMETERS EASY TO CHANGE
- \* AUTO-SCALING OPTIMIZES GRAPH SIZE
- \* FIND AND COMPUTE FUNCTION VALUES & ZEROS
- \* INTERSECTION OF FUNCTIONS
- \* COMPLETE MANUAL — PROGRAM ON TAPE

**CALCULUS MATH MODULE 32K EXT-\$34.95**

- \* STARTS WITH THE GRAPHING MODULE
- \* LOAD UP 9 FUNCTIONS AT ONCE
- \* FIND AND COMPUTE MAXIMA & MINIMA
- \* NUMERIC INTEGRATION & DIFFERENTIATION
- \* COMPOSITE AREAS
- \* HANDLES PIECEWISE CONTINUOUS FUNCTIONS
- \* HARD COPIES OF DATA AND/OR GRAPH
- \* COMPLETE MANUAL — PROGRAM ON TAPE

**CALCSOFT**  
P.O. BOX 401  
ST. ANN, MO 63074

**CHECK OR MONEY ORDER — \$1.00 for shipping**

```

8, 7, 15, 6
1030 DATA BRIDLA, 11, 12, 10, 15
, 6, 11, 16
1040 DATA DERNFARA, 13, 13, 8, 1
3, 4, 17, 6
1050 DATA JOLEEN, 13, 11, 7, 13,
8, 17, 13
1060 DATA ROKANA, 9, 9, 9, 17, 1
8, 9, 10
1070 DATA ENDFILE, 0, 0, 0, 0, 0
, 0, 0

```

Lines 1010 through 1070 are a *data file*. This file consists of seven *records*. Each record consists of a character's name followed by seven numbers. For instance:

```

1030 DATA BRIDLA, 11, 12, 10, 15, 6, 11, 16
      ↑           └──────────────────┘
      Name       Seven numbers

```

The last record, which begins with ENDFILE, is not an actual character record. Instead, it is an *end-of-file* (EOF) record. If you enter a name that is not in the file, the CoCo will search in vain and arrive at ENDFILE. It will then print I DON'T KNOW followed by the name you entered. This will also happen if you misspell a name that is in the file, or even if you ask it for ENDFILE.

ENTER the program and type RUN. It begins like this:

NAME OF CHARACTER?

Type BRIDLA and press the ENTER key.

```

NAME OF CHARACTER? BRIDLA
STR      11
CON      12
SIZ      10
INT      15
POW      6
DEX      11
CHA      16

```

Well, *almost* any key.

TO DO AGAIN. PRESS ANY KEY

You can change these records to records for *your* characters. Remember to put ENDFILE in the last DATA statement.

Your turn. Write a program to display the entire file, one record at a time, beginning with the first record. To get the next record, press the space bar.

What happens when you tell the computer to compute a random number of a random number? For instance, suppose you tell the CoCo to compute:

RND(RND(2))

Hieronymus Heuristicus wrote a program to find out. His program counts how many ones and how many twos occurred in a sample of RND(RND(2)) numbers.

"Well, an RND number is an RND number," thought H. H. as he typed RUN. "I'll get about the same number of ones and twos." But here is what actually happened.

```

HOW MANY RANDOM NUMBERS? 100
POSSIBLE VALUE      NUMBER OF TIMES
1                    73
2                    27
TO DO AGAIN. PRESS ANY KEY

```

Surprised, he tried again.

```

HOW MANY RANDOM NUMBERS? 1000
POSSIBLE VALUE      NUMBER OF TIMES
1                    758
2                    242
TO DO AGAIN. PRESS ANY KEY

```

Perplexed by this strange behavior of usually predictable unpredictable numbers, H. H. called his friend, Annalee Analyticus. After hearing what happened, A. A., chuckled, then told her friend why it happened.

**ARCADE - CONTROLS!**

NOW USE ATARI®-TYPE JOYSTICKS ON THE COLOR-COMPUTER!

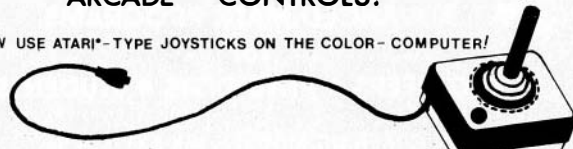

ATARI® JOYSTICK INTERFACE / ALLOWS ALL ATARI®-JOYSTICKS TO WORK WITH THE COLOR-COMPUTER! HAS COMPUTER ON/OFF INDICATOR. INTRODUCTORY PRICE ONLY \$19.95!

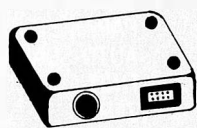

ACC-U-FIRE PADDELS / ATARI®-TYPE GAME PADDELS PLUG INTO COLOR-COMPUTER FOR IMPROVING SCORES! WORKS ON HOR. & VERT. GAMES. ONLY \$19.95!



GREEN-PHOSPHOR ADAPTER / NOW PRINT GREEN ON BLACK SCREEN! ALL HARDWARE, NO SOFTWARE! NO SOLDERING! AND ONLY \$19.95!

ATARI® JOYSTICKS \$6.95/ JET FIGHTER STICK \$19.95.  
WE CARRY TOM-MIX & MARK-DATA.

**MICRO-DIV.**  
450 W. LASKEY  
Toledo, Ohio 43612  
1-419-476-6282

ASK FOR MICRO-DIV.

C.O.D. Credit Card  
orders accepted / add \$2.00 shipping

DONKEY KING..... \$24.95  
PROTECTORS..... 24.95  
ASTRO-BLAST..... 24.95  
SPACE RAIDERS..... 24.95  
MOON-LANDER E.B. 19.95  
HAYWIRE..... 24.95

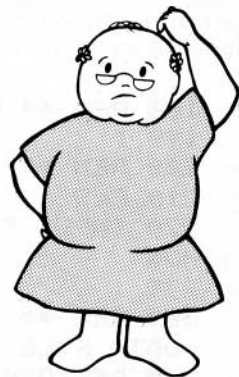





# COLOR COMPUTER/TDP-100



## COLOR ALIEN DEFENSE

by Doug Schwartz

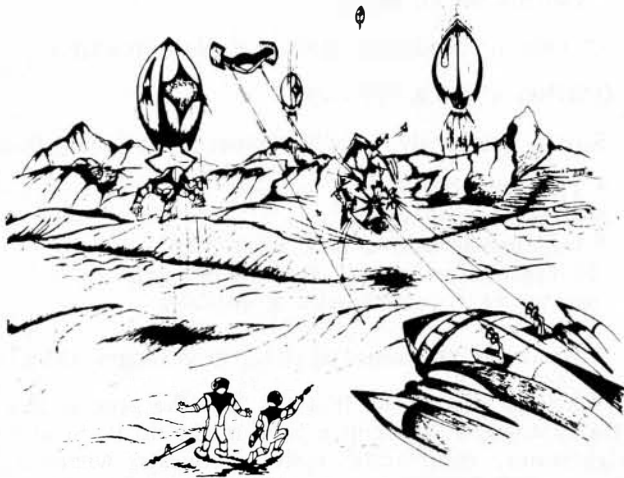

One of the fastest action arcade games!  
Written in Machine Language.  
16K Cassette **\$19.95**

## COLOR CATERPILLAR®

by Rugby Circle

**RATED # 1**  
"Better Graphics and Sound than Colorpede."



Don't settle for less. Be sure to ask if the program was produced by Soft Sector Marketing so you don't get the wrong version.

16K Cassette **\$19.95**

Machine Language

## DEATH TRAP

by Rugby Circle

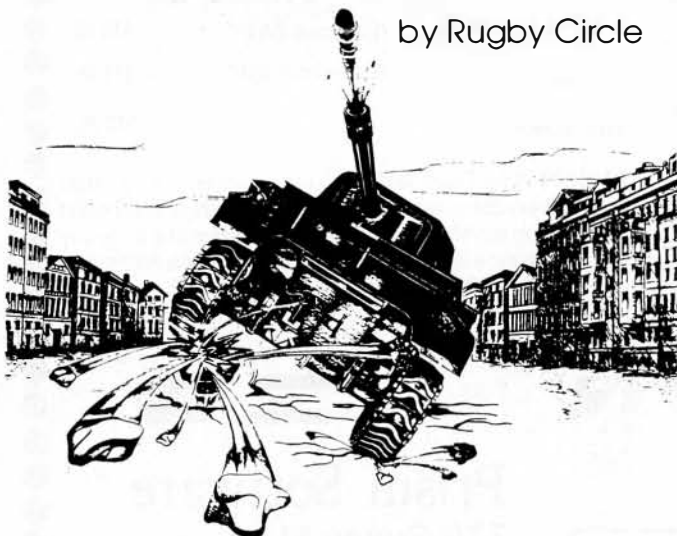

A larger-than-screen maze game. Arcade style, fast-action. Written in Machine Language. Requires Joystick.

16K Cassette **\$19.95**

## COLOR GRAPHIC EDITOR

by Larry Ashmun

At last, a true Graphic Drawing program that permits the creation of graphic pictures on the screen storing them in one of 4 locations, and recalling them as needed for review.

The pictures can be saved to disk to be loaded into the micro works disk editor. The graphics are saved in Assembler format or Basic Data Statements, but details are provided for using the information in a BASIC program. Works on cassette or disk systems.

Cassette **\$19.95**

Written in Machine Language, but requires Extended or Disk Basic.

**SSM** SOFT SECTOR MARKETING, INCORPORATED

6250 Middlebelt • Garden City, Michigan 48135

Order Line **800-521-6504**

Michigan Orders & Questions 313-425-4020



**PAYMENT** - payment accepted by charge, personal check or C.O.D. only, under the following conditions. **Charges** processed when shipped, usually within 48 hours. **Personal** **Checks** delay shipping, pending 3 weeks to clear. **C.O.D.**

Orders are certified check or cash only, add \$1.50. MI residents must add 4% sales tax. **SHIPPING & HANDLING - Shipping Charges:** Send the larger amount, 2% of \$2.50, unless stipulated otherwise. Any order received without shipping and handling will be shipped **freight collect**. **Air Mail Shipping** outside of North America, please send the larger amount, 10% of \$10.00. Overpayment will be refunded.



\* What did A. A. tell H. H.? Why did the computer compute lots more 1s than 2s for RND(RND(2))?

\*When the CoCo computes the value of RND(2), the probability of getting 1 is one in two; the probability of getting 2 is also one in two. For RND(RND(2)),

- (a) what is the probability of getting 1?
- (b) what is the probability of getting 2?

\* Hmm...what about RND(RND(3))? The *possible* values are 1, 2, or 3. Modify Hieronymus's program so the computer counts how many 1s, 2s, and 3s occur in a sample of RND(RND(3)) numbers. Can you predict what will happen *before* you run the program?

\* Then try RND(RND(4)) or RND(RND(5)) or...

### COMING ATTRACTIONS

Surely, but slowly, we will explore the following things:

- \* The elusive RND
- \* GameMaster's Dice
- \* Looking up stuff in files. First, files of information in *DATA* statements and arrays. Next, cassette files. Eventually, disk files.
- \* Whatever else comes to mind, or is suggested by you.

What do *you* want? If it fits into the general idea of "GameMaster's Apprentice," we might do it. Send your suggestions, complaints, kudos, requests, whatever...to George & Bob, P.O. Box 310, Menlo Park, CA 94025.





Dealer Inquiries welcome  
Quality color computer software  
All Software on tape only  
All games require 16 K except where noted



ARCADÉ GAMES



**★ By Spectral Associates ★**

GHOST GOBBLER	\$26.95	ROBOT BATTLE	\$26.95
ALCATRAZ II	\$11.95	PLANET INVASION	\$26.95
GALAX ATTAX	\$26.95	COSMIC INVADERS	\$26.95
SPACE WAR	\$26.95	SPACE RACE	\$26.95
KEYS OF THE WIZARD	\$23.95	DEFENSE	\$26.95

**★ By Mark Data Products ★**

BLACK SANCTUM	\$28.95	ASTRO-BLAST	\$30.95
CAVE HUNTER	\$28.95	CALIXTO ISLAND	\$28.95
BERSERK	\$30.95	SPACE RAIDERS	\$30.95

**★ By Computerware ★**

COLOR PAC ATTACK	\$30.95	STARSHIP	
DOODLEBUG	\$30.95	CHAMELEON	\$30.95
RAIL RUNNER	\$30.95	STORM	\$30.95

**★ By Intracolor ★**

COLORPEDE	\$35.95
-----------	---------

**★ By Tom Mix Software ★**

DONKEY KING	\$30.95
-------------	---------

requires 32 K

CHOPPER RESCUE	(Extended BASIC)	\$13.95
LAS VEGAS	(Extended BASIC)	\$11.95
THE ALIEN		\$13.95

RAIDERS "By Prism Software" In this adventure you must deal with voodoo curses, alligators, ancient traps and hostile natives. This adventure begins in the confusion of a large city and ends (maybe too soon if you're not careful) in a dangerous, dense jungle in South America.  
(Extended BASIC) **\$16.95**



**Prism Software**  
779 Queen St.,  
Box 1360, Kincardine,  
Ontario, Canada. N0G 2G0  
Tel: (519)396-8224

Add 5% for shipping  
No C.O.D.  
VISA or Mastercard accepted  
Ontario residents add 7% sales tax

Please allow  
**2-3 weeks for delivery**

16 the RAINBOW March, 1983



# COLORSOFT™ BUSINESS SOFTWARE

**AT LAST! BUSINESS SOFTWARE DESIGNED FOR THE COLOR COMPUTER**

- ★ MAKE YOUR COLOR COMPUTER A WORKING BUSINESS PARTNER ★
- ★ ALL PROGRAMS ARE MENU DRIVEN AND USER FRIENDLY ★
- ★ PROFESSIONALLY WRITTEN AND FULLY TESTED ★
- ★ AFTER-THE-SALE SUPPORT ★

**SMALL BUSINESS ACCOUNTING PACKAGE**...Ideally suited for any small business with up to \$1,000,000 in annual sales and 400 accounts receivable and 400 accounts payable. This package provides detailed record keeping on accounts receivable and payable, sales, purchase orders, and allows input and maintenance of payroll related data. Prepares balance sheet and income statement, aging reports, and displays a check register, a listing of sales by date, and a listing of individual purchase orders. Included are printer output options. The step-by-step user's manual and the user friendly, menu driven format makes this program package fast, efficient, and easy to use.  
**REQUIRES SINGLE DISK DRIVE (User's manual without program \$20)..... \$149.95**

**DEPRECIATION**...Determines depreciation values for assets based upon the new accelerated cost recovery system (ACRS) and the alternate ACRS methods in addition to the conventional methods. Adjusts for placing assets in service during the year. Screen or printer output..... **\$22.95**

**LOAN ANALYSIS**...Evaluate cost of borrowing for capital investments or business expansion. Prints amortization schedules and allows user to determine loan status at any point in the term of a loan. Other options allow user to determine either principle, interest, payment, or term based upon input of any three. An auto loan option includes trade-in allowance and taxes. Screen or printer output..... **\$20.95**

**ANNUITY**...Determine future value of investments, present value of a future amount, compound interest, and amount of an individual retirement account (IRA). Screen or printer output..... **\$18.95**

**EXPENSE ACCOUNT DIARY**...Keeps a record of travel expenses for up to 25 trips per year. Performs file searches based upon cross-referencing of date of trip, city visited, hotel, or purpose of trip. Screen or printer output. An excellent program for the traveling businessman..... **\$15.95.**

**STOCK ANALYZER**...Reviewed in July 1982 RAINBOW. New version provides printer output and is disk compatible. Maintains a stock portfolio data base of multiple stocks. Can be used to track performance of sales personnel or similar applications. Features graphing of data to screen or printer along with analyses that includes projection of data trends ..... **\$21.95.**

---

INCLUDE \$2.25 HANDLING PER ORDER  
ALL PROGRAMS REQUIRE 16K EXT. BASIC  
CUSTOM PROGRAMMING SERVICES AVAILABLE  
WRITE FOR FREE CATALOG

---

**COLOR  
SOFTWARE  
SERVICES**

BUSINESS SOFTWARE DIV.  
P.O. BOX 1708, DEPT. R  
GREENVILLE, TEXAS 75401



DEALER INQUIRES INVITED

TELEPHONE ORDERS  
(214) 454-3674  
9-4 Monday-Saturday

VISA/MASTERCARD



# Screen-To-Printer Color Graphics

By Lane Lester, Ph.D.

*Breathes there a CoCoNut with soul so dead,  
Who never in his heart of hearts has said,  
"Oh, how I wish I could make color copy  
Of that display on my color TV!?"*

The dim recesses of my mind which produced shreds of the poem that stimulated the couplet above just will not produce the author's name so that I can apologize to him. As tragic a blow as my efforts may be to the world of literature I am sure that the poem does indeed express a feeling that many of us have had. Imagine my delight when Francis Kalinowski published "Printer Color Art" in the September 1982 issue of *80 Micro* which showed how to make beautiful multi-colored pictures on the Epson MX-80. Because you're probably not as lazy as I am you can't imagine my disappointment when I realized how much programming would be involved to produce each picture. Sadly I set aside the tools that Francis generously provided and went on to less-demanding tasks.

But now the light has dawned again! Using programs provided for us by two giants of the CoCo world it is possible for indolent folks like me to have beautiful reproductions of screen graphics. Arnold Pouch, now deceased, developed Motion Picture Programming based on a drawer program in the August 1981 issue of *Chromasette*. This powerful technique which Arnold described in the March and April 1982 issues of *the Rainbow* makes the creation of graphic displays a pleasure. A complete set of programs and a tutorial are available from Superior Graphic Software, or you can buy the



Chromasette and use *the Rainbow* articles to make the changes to MPP. Making printer copies of MPP graphics is a snap with the Graphic Screen Print Program (GSPR) sold by Mel Hefter of Custom Software Engineering. Versions of this program are available for most of the popular printers. While this means that anyone can at least have black-and-white screen prints, the availability of colored ribbons will determine whether color prints are possible. Colored ribbons for a number of printers are available from Check-Mate and from B.T. Enterprises. A list of suppliers' addresses is given at the end of this article.

The illustrations that accompany this article demonstrate the results you can expect. The jack-o-lantern came from a program I wrote to run Halloween night with the TV in our bay window. It was done in PMODE1 which gave me four different graphics which could be switched and provided Jack with the ability to blink, wink, and "talk." The giraffe was done by projecting a 35mm slide on the wall and tracing it onto a clear plastic sheet. This sheet was taped to the television screen, and then the MPP program was used to create the graphic. In PMODE3, one graphic has the eyes open and the other, closed. A formula using RND provides a very natural blinking of the eyes. If you've had a biology course recently enough you may realize that the picture with the blue blobs represents the electron transport system. This is from an MPP animated graphic series in PMODE1 that I use to illustrate one of my biology lectures. The three-color graph illustration was produced by a graphing program I published in the March 1982 issue of *Color Computer News*. The lettering on the graph was done with another program available from Custom Software Engineering, *Alpha-Draw*, which can be added to any graphic program.

"Enough," you say, "I'm sold. Now how can I make color prints of graphic screen displays?" In addition to the appropriate hardware and supplies, you first need to get and learn to use the MPP program. I'm going to assume you've done that in the following discussion. The GSPR program is in machine language and comes with instructions for editing Basic programs such as MPP so that they will load and execute GSPR. In addition to those changes I added to line 22 of MPP an "L" option which *GOSUBs* to "330 X=USR1(0):RETURN", executing the screen print.

Although typical screen graphics have several colors, they must be altered considerably in order to produce color





prints. This is necessary because each color requires a separate pass through the printer with a different ribbon in place. For each color in the print, that part of the screen display is changed to red (simple with MPP) which with GSPR gives the densest printing. The rest of the graphic is erased to green which is unprinted. In your original graphic program you may use the eight pages of graphic RAM for animation, but for the screen print you can use them for multiple copies of the graphic. In PMODE I you could store four different versions, one for each of four colored ribbons. If you are using more than four colors or a higher PMODE, you would make separate saves of the graphics which with MPP is rapid (at least with disk) and convenient.

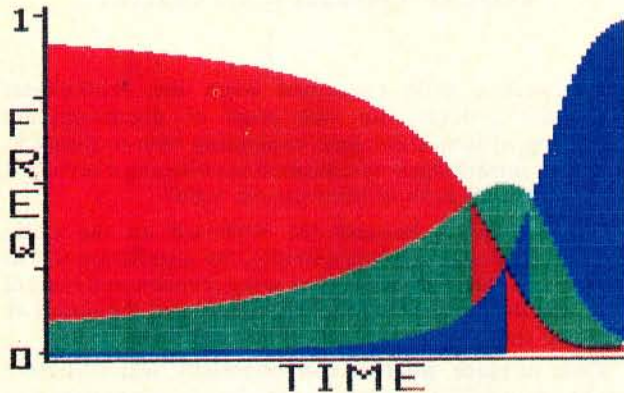



In order that the different colors will be properly located on the paper, accurate re-positioning of the paper for each pass is critical. This should be quite easy with most printers. On the Epson, just to the right of the left tractor lock, is a black horizontal ridge which serves as an index. The brand of paper I use is numbered along the left perforated strip and after each run I return the paper to the same number. If your paper is not numbered or your printer does not have an index, Francis Kalinowski, in his *80 Micro* article, suggests placing a piece of paper tape at the edge of the tractor. Then you can make a pencil mark across the tape and onto the paper to use as a guide. So that with each run the paper will have the same tension, I rewind past the number and then return. Francis suggests an even more precise approach, and if you run into problems you might want to consult his article. He does make two very worthwhile suggestions, that you use 20-pound white bond paper and that you unlock one of the pin-feed mechanisms to prevent paper buckling. To give a greater depth of color for publication, I ran the paper through twice for each color, but generally this is not necessary.

#### Suppliers

B.T. Enterprises, 10 B Carlough Road, Bohemia, NY 11716  
Ribbons in 5 colors for Epson, NEC and ProWriter.  
Check-Mate, Box 103, Randolph, MA 02368  
Ribbons in 6 colors for Epson, Radio Shack II and V,  
Okidata, and Paper Tiger.  
Chromasette, Box 1087, Santa Barbara, CA 93102  
Single issues \$6.00 = \$1.00 S&H

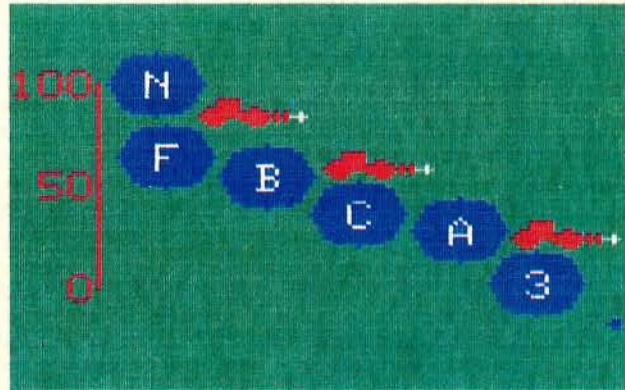
Custom Software Engineering, 807 Minutemen Causeway,  
Cocoa Beach, FL 32931  
Alpha-Draw \$8.95  
Graphic Screen Print program \$7.95 (LP VII/VIII, DMP-100/400)  
\$9.95 (others)  
S&H for each order \$1.00  
Superior Graphic Software, 406 Little Mountain Road,  
Waynesville, NC 28786  
MPP Tutorial, \$34.95





The  
Home  
Buyer's  
Analyzer

**THE HOME PURCHASER'S  
"WHAT IF" TOOL  
FOR THE  
COLOR COMPUTER**

---

- Program Projects up to 40 Years, and Computes:
  - \* Mortgage Balance
  - \* Mortgage Payment
  - \* Effective Payments after Taxes and Appreciation
- Displays Year of Purchase & Year of Sale Figures
- Automatically Adjusted Federal Tax Schedules in Program
- Considers Balloon (*Variable Rate*) Mortgages
- Detailed Documentation Booklet Provided ● Graph Results
- Stores Input for Future Runs ● Printer/Monitor Output

- Requires Extended Basic
- Cassette - 32K Required
- Printer Optional
- Disk - 16K Required



**PRICE \$34.95 CASSETTE or \$39.95 DISK**

Send Check or Money Order (*N.J. Residents Add 5% Sales Tax*) to:

**SILVER SPRING SOFTWARE**  
18 Silver Spring Road, West Orange, N.J. 07052  
*(Dealer Inquiries Invited)*

## Wall Street Touted As Good Investment

I suppose that in the back of the minds of many of us is the dream of someday making a killing in the stock market, or watching a handful of dollar bills multiply into hundreds of thousands of bucks, of Swiss bank accounts, and of having the problem of figuring out how we're going to spend so much money. The reality for most of us, however, is that those few extra dollars are hard to find for us to get started on the road to riches.

Part of the beauty of *Wall Street* is that Valhalla Enterprises has been generous enough to provide each of us with \$1,000 to get started. The rest is up to the individual and how he or she takes advantage of all the helpful information, such as stock and market histories and general trends that are part of the game. Individual hunches also are important, of course.

A couple of bars of "We're In The Money!" at the opening put us in an optimistic mood for what is a challenging, fascinating and colorful game. I would think that even those sleepy-looking elderly chaps who spend their lunch hours daily watching the big board would be caught up in this game.

Tailored for one to four players, *Wall Street* first asks for the names of the participants. The group is then asked for the amount of earnings that will determine the winner (if you want to play to \$3,000, enter "3,000"). Actually, \$3,000 is a short game for two people, taking between 10 and 20 minutes, depending upon their skill and luck. A \$10,000 game probably will take four people about an hour if they move along at a good pace.

The stock exchange screen gives you the current price for eight stocks:

Utilities — Energetic Electric, Wishwashy Water;  
Blue Chips — Mammoth Motors, Stupendous Steel;  
Glamors — Calculating Computers, Albatross Aircraft;  
High Risk — Pinchpenny Prospecting, Risky Research.

The current month is displayed in the upper righthand corner. The condition of the overall market is also shown (up, down or even). At the bottom of the screen is a list of possible actions: Pressing "P" lets you see your account along with your holdings and disposable income; the "S" key gives you stock history graphs, and "M" displays the market history.

An individual player's screen gives you the options of buying or selling. If you press "B" you are asked "Which Stock?" Typing the initial of the stock then gives you the history of that company's trends. A similar procedure is followed if you're selling.

After the round (or "month") of transactions is completed, be ready for some surprises because, just as in the real world, the stock market reacts to many other events, such as labor strikes and rumors of war. Then, of course, there are pleasant surprises, such as big dividends and 2-for-1 or 4-for-1 stock splits. You can just imagine the floor of the New York Stock Exchange when such excitement occurs.

*Wall Street* is an excellent game for teaching the ins and outs of the stock market, as well as the patience and knowledge required to give investments the opportunity to

grow. It's also a good game to demonstrate CoCo's versatility. Warning: Like CoCo, the game also is contagious, and you should prepare yourself for hours of fun. *Wall Street* is a great investment!

(Valhalla Enterprises, P.O. Box 243, Sumner, WA 98390.  
\$9.85 on tape, 16K required)

—Charles Springer

### Hardware Review...

## This Keyboard Is A Good Quality Product

We were a little concerned when the *Professional Keyboard* arrived with one page of documentation consisting of four short lines explaining how to install it. After all, something as complicated as replacing a keyboard should have all sorts of information, right?

Not to worry. Because the keyboard on the Color Computer is connected very simply, the installation was as easy as it looked. Total time was seven minutes, and some of that was due to the fact that we lost one of the screws to reattach the cover to CoCo.

Once in place, what we had, essentially, was a Model I keyboard in a Color Computer case. The fit was perfect. The touch was good and there were no real problems. As of this writing, the *Professional Keyboard* has been installed for the better part of three weeks with no trouble whatsoever.

It takes a bit of getting used to. But, if you are one of those people who is unhappy with the flat Color Computer keyboard, this product is a real gem.

The keys, of course, are higher than those for the Color Computer. And the *ENTER* key is located at a slightly different place. That took a little getting used to—but the touch-typists around here have taken to the *Professional Keyboard* much like the proverbial duck to water.

It also has four function keys. Unfortunately, there is no documentation to tell you how to use them. We hope an addenda to the instructions will be forthcoming. And, of minor concern, it is obvious that keyboard overlays for some products such as the Platinum *Worksaver*, *Master Control* and *Basic Aid* will not fit this new keyboard. A small price to pay if you want to replace your keyboard.

We have heard more complaints about the Color Computer's keyboard than anything else. For those of you who do not like it, the *Professional Keyboard* offers an excellent alternative that is well put together and works without any problem.

You may notice that we refer to the "Color Computer" throughout this review. The reason is that the *Professional Keyboard*, as of this writing, is not available for the TDP-100, nor for Color Computers with an "F" revision board. We understand, however, that one is in the works.

(Spectrum Projects, 93-15 86th Drive, Woodhaven, NY  
11421, \$89.95)



# Turn your color computer on to the power of FLEX

NOW FROM THE WORLDS LARGEST SUPPLIER OF SOFTWARE FOR FLEX  
COMES FHL COLOR FLEX. JUST LOOK AT THESE FEATURES:

**IF YOU'RE TIRED OF  
NO DISK SOFTWARE,  
THEN FHL Color FLEX  
IS THE ANSWER!**

FLEX is the world's most popular operating system for the 6809 and with over 150 programs, we are the largest supplier of software for FLEX. These programs are NOT games but serious programs for your Color Computer. They range from word processors thru business applications to software development tools. Many Fortune 500 companies use our software. FHL Color FLEX turns your Color computer into a powerful system more capable than systems costing several times as much.

See our NEW 32 page catalog in the Jan. '83 issue of COLOR COMPUTER NEWS featuring over 150 products for FLEX, or send \$3.00 to us and we will see that you receive a copy!!

## **FLEX NOW ONLY \$99**

- NEW - "Tiny Editor"
- NEW - Interactive Assembler (Tiny ASM)
- NEW - Machine Language Monitor
- NEW - Video attributes include status lines, protected lines, and inverse video
- Hi-Res screen formats
  - 16 x 32 and 24 x 51, upper and lower case characters
  - 24 x 64 and 32 x 64 upper case
  - Full ASCII keyboards
- Easy start-up—just type "FLEX"
- On-line assistance—Just type HELP
- Optionally use a standard terminal and printer
- Advance disk I/O and terminal capabilities - Supporting 35, 40, and 80 track single or double sided, single or double density drives
  - No additional hardware required
  - We have supported FLEX with more than any one else in the world for more than two years!

## **SPECIAL**

1. DBASIC, RS Disk Basic under FLEX with a utility to copy RS to FLEX disk \$30.
2. ED/ASM, line and screen editor with conditional macro assembler, both more powerful than TSC's and at the same cost, only \$100.
3. COLOR UTILITIES, a set of 12 utilities especially designed for FHL COLOR FLEX \$50.



THE REGENCY TOWER  
770 JAMES ST. · SYRACUSE, NY 13203  
TELEX 646740 · (315) 474-7856

**FHL** FRANK  
HOGG  
LABORATORY

\*FLEX is a trademark of Technical Systems Consultants Inc.



1. Here is Jeri plugging The Solution into the CoCo. Then she will move the main case up close to the CoCo. The cable is kept short to prevent noise and interference. The disk controller can be plugged into the side slot. The power supply plugs into a socket on the back of the case. All wires for the internal boards exit out the back of the case.



2. Here Jeri is setting the dip switches in The Solution. The hinged top makes the job easy. The switches can be set for three different things. Up to four boards can be installed inside the case.



3. Here is The Solution at work. It makes a very nice addition to your CoCo with a black anodized top and a silver anodized main case both made from heavy aluminum stock.

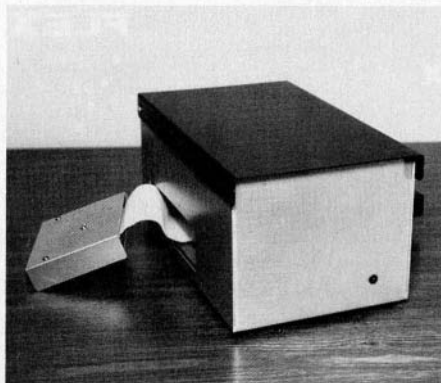

4. Here's The Solution all by itself. The heavy aluminum anodized case is a thing to be proud of. The bufferboard can be seen to the left of the main case. The LED indicator on the front comes on when you turn on the power to your CoCo. The Solution needs no on/off switch.

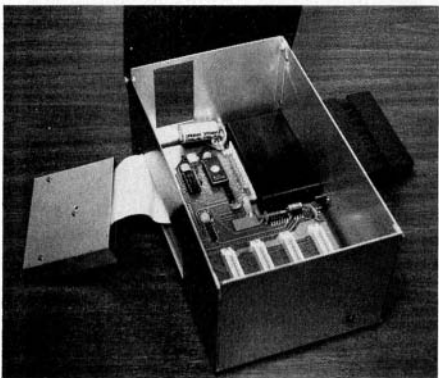

5. All that's missing from this picture is the plug in the wall power supply. You can see the 4K EPROM monitor and the 4 position dip switch. At the front are four of the five expansion slots with a disk controller plugged into the fifth slot on the side. The power LED is at the lower right front of the case.

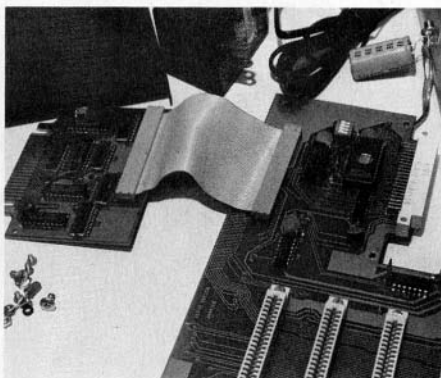

6. Here's the real guts to The Solution. We took it all apart so that you could look at the parts. The 1 amp power supply can be seen in this picture. All the connectors are gold as you would expect. The small board is the buffer board. The white connectors are the same as the CoCo's.

## THE SOLUTION AND WHY WE BUILT IT

When we first introduced FLEX for the CoCo in February 1982 we received hundreds of calls from software and hardware developers who wanted to use the CoCo because it was so inexpensive compared to everything else on the market. However there is not enough expansion or I/O in the CoCo to make this possible for most of these users. I know that the CoCo is viable in most cases, but for many, there needed to be more. So that was the original reason for designing the expansion box we call "THE SOLUTION."

The motherboard has the 2K/4K EPROM socket with a 4K monitor EPROM in it. Also inside are 4 vertical connectors for internally mounted boards or ROM type cartridges. The fifth connector is horizontal and is made for the disk controller, ROM cartridges or additional expansion out the side of The Solution. A four position dip switch allows for 3 options to be selected. One option will cause the CoCo to get its interrupt and reset vectors from the monitor instead of RS Basic.

If you choose to come up in the monitor, then it is not necessary to have RS Extended Basic in the CoCo to boot FLEX because the monitor has a built-in boot. This saves \$100.00 of the cost of The Solution. The power supply is a plug-in-the-wall type with a connector in the back of the case. The back of the case is open and it is thru this that all the cables for the different cards go. This makes for a very neat appearance.

## TECHNICAL SPECIFICATIONS

**Bus Structure...**Fully buffered Color Computer compatible bus. Priority daisy chained arrangement where each slot has a priority assigned to it. The farther out on the bus that you are, the less priority you have. The disk slot (0) has the highest priority with slot 1, 2, 3, and then 4 has the lowest. The pinout and the timing is the same as the Color Computers with the exception of the sound line. This is used on the motherboard for the priority line.

**Power Supply...**The power supply is a tracking power supply which means that the Color Computer itself turns The Solution on and off so that there is no need for an on/off switch. A LED on the front of The Solution indicates when the entire system is on or off. The tracking power supply means that The Solution's bus voltage will be the same as the Color Computers to within a very few millivolts. The power supply included with The Solution is a 1 amp supply for the 5 volt line only. The +12 and -12 voltages are taken from the Color Computer.

### Dip switch options...

1) Select the 4K ROM monitor. When this option is selected, the system will come up in the monitor and get interrupt vectors from it rather than the Radio Shack Basic ROM. The reason you might want to do this is so you can boot FLEX from the monitor rather than Basic. This will allow running FLEX without have to have Extended Color Basic in the CoCo. This also ties in with the option on the serial card to come up on a terminal instead of the CoCo TV set and keyboard.

2) Disable the disk slot (0). This will allow using ROM cartridges in The Solution without unplugging the disk card. When the switch is on, the ROM is active. When it is off, whatever ROM cartridge is there is active. This infers that you could switch back and forth between a cartridge and the disk system. This is NOT necessarily true because of the need to initialize the disk software in the ROM and this may destroy what is in memory. It may be possible under special circumstances to do this but it is up to the user to work it out.

3) Select either a 2K or a 4K EPROM. This is set for a 4K EPROM which is included with The Solution. However, it can be changed if you have a need. The EPROM is addressed at \$E000.

4) User definable. This means that we didn't use this switch for anything, but you can if you want, or we could call it "reserved for future expansion." This means that we don't have any use for it now, but we may in the future.

The Solution I/O cards are addressed at either the \$FF60-\$FFBF area OR the \$FE00-\$FEFF area.

These prices and specs are subject to change without notice. Call for confirmation.

**THE SOLUTION** \$249.00  
(Price includes case and power supply.)

### CARDS FOR THE SOLUTION

**DUAL SERIAL PORT** \$130.00  
Two 6551 ACIAs, programmable baud rates (110-19,200), full RS-232, DB-25 conn.

**CLOCK and PARALLEL PRINTER CARD** \$110.00  
OKI clock w/battery backup and 1 parallel output port

**PROTOTYPE Cards** \$ 37.00  
3 1/2 by 9 inch card

**EPROM/RAM Card** \$ 90.00  
Up to 16K ROM (2732) or 8K static RAM (6116). Each device individually addressed anywhere in memory

**EPROM programmer** \$165.00  
Program 2K, 4K or 8K EPROMS. Software included either on disk or on board ROM.

**TRIPLE PARALLEL I/O Card** \$105.00  
Two 6821's and one 6522 for parallel I/O.

Note: We are considering several other cards for The Solution. Please let us know what you want, if there is enough interest, we will make it.

**FHL FRANK HOGG LABORATORY**

THE REGENCY TOWER • 770 JAMES ST. • SYRACUSE, NY 13203 • TELEX 646740 • (315) 474-7856



**FRANK HOGG LABORATORY, INC., IS PROUD TO ANNOUNCE THE  
ADDITION OF SEVERAL NEW PROGRAMS TO OUR PRODUCT LIST!!**

**From Windrush, in England:**

**MACE - A 6809 Assembler and Co-resident editor.**

A co-resident EDITOR/ASSEMBLER written by Graham Trott, which takes most of the pain out of assembly language program development. Allows programs to be written, edited, assembled, and de-bugged without ever entering the disk operating system. Includes XMACE, a co-resident 6800/1/3 EDITOR/CROSS/ASSEMBLER.

6809 FLEX only                      \$98.00

**PL/9 - A 6809 compiler with co-resident editor and co-resident trace-debugger.**

A co-resident EDITOR/COMPILER/DEBUGGER written by Graham Trott. A single pass compiler that produces position independent machine code output. Supports many BASIC, SPL/M and PASCAL structures. Supports 8 bit and 16 bit signed AND 32 bit floating point variables. FLEX I/O, floating point, and scientific functions library (w/source) included.

6809 FLEX                              \$198.00

**From Computerware:**

**INVENTORY CONTROL FOR RETAILERS & DISTRIBUTORS:**

Designed to help you keep control of this important aspect of your business, this program allows you to store your cost and quantity information, updates it immediately, and offers key management reports with useful summaries at any time upon your request.

CC FLEX version                      \$195.00

**CHECK LEDGER SYSTEM:**

A single entry bookkeeping system which allows the user to define multiple income and expense accounts. Deposits are assigned to income accounts while cash disbursements by check are assigned to expense accounts. Multiple expense assignments may be made for a single check, allowing easy recording of petty cash, credit card payments, etc.

CC FLEX version:                      \$195.00

**GENERAL ACCOUNTS RECEIVABLE SYSTEM:**

Provides reliable and timely information regarding the status of all customers accounts. You can know instantly which accounts are past due, forecast how much money to expect to receive for cash flow planning, and keep on top of your customer credit position.

CC FLEX version:                      \$149.00

**ACCOUNTS PAYABLE SYSTEM:**

Can give you the tools to plan your business growth by controlling expenditures and forecasting cash requirements. This system helps a small business manage and track its cash liabilities by collecting vendor invoice information and reporting the business cash commitments and payment history.

CC FLEX version:                      \$195.00

**PAYROLL PROCESSING SYSTEM:**

Records key information on all employees. Allows for entry of pay rates for standard hours, overtime hours, and salary. Handles hourly, salary, and commissioned employees, as well as, weekly, bi-weekly, semi-monthly, and monthly pay periods. Once all pertinent information is keyed in, processing takes seconds.

CC FLEX version:                      \$295.00

**CORRESPONDENCE SYSTEM:**

The system collects name and address information and then provides mailing labels or reports of the entire list or subgroups within the list upon your request. You can add names, delete names, or change information for a given name at any time, keeping your list accurate at all times.

CC FLEX version:                      \$149.00

(These business programs are also available for FLEX and OS-9. Please contact us for prices. All of these require Computerware's Random Basic.)



## The Forgotten Aspect Of the Classroom Computer

By Dr. Paul Kimmelman  
Assistant Superintendent  
Norton (Ohio) City Schools

Educators are being inundated daily with advertisements from a whole host of computer dealers. These dealers include: computer hardware specialists, software specialists, and many resource book companies. Unfortunately, while educational computer purchasers are seriously reviewing computer hardware, software, and resource materials, an important aspect of future computer implementation is being forgotten—that is, what will the computers and peripheral equipment be placed on? Where will programs be stored? It should be noted that this may not be a major problem for schools at this time; however, individual classroom computers will more than likely eventually become part of a computer lab and furniture will be an important aspect of the design in the lab.

One company, Gusdorf Electronics Furniture, has designed a line of furniture that will more than meet the needs of public schools. In addition, Gusdorf has priced its equipment very reasonably considering some of the major advantages that it offers over several other comparably priced companies' products.

There is little doubt that computer furniture has not been given much thought while educators have been pressing to expand their hardware and software inventories. With equipment prices falling, however, we must begin to look at furniture as part of the plan to implement computer classes in school districts. The Gusdorf line will meet those needs through its carefully planned expandability options for a variety of classroom designs.

First, Gusdorf furniture is carefully packaged in order to prevent damage while being shipped. Once uncrated, the directions for assembly are written so that even the novice mechanic could put it together. What is even better is that assembly takes less than thirty minutes.

For schools, the design and appearance of the furniture are a major advantage. All of the furniture has a Paradise Hickory veneer which is very attractive. The wood panels which are primarily Appalachian Poplar will resist warping, splitting or cracking and are veneered with a heavy-gauge vinyl grain finish.

Table tops are made of formica which will also prevent scratches and marring. This is extremely critical for school use since students will often use the desks for writing as well.

Self-adhesive rubber accessories are packaged with Gusdorf furniture to combine wires and attach them to the back of the furniture. This is a convenience accessory in that it prevents many wires from merely dangling in the back of the furniture.

Storage is an exceptional component of the computer furniture line. For example, under the hutch desk unit is a shelf which can house the many notebooks, disks, cassettes, and manuals that the user wants to keep out of the way but easily accessible.

The hutch desk is spacious and designed to handle a complete computer set-up. For the Color Computer user, the hutch desk would enable the user to house the keyboard, monitor, and a cassette or two disk drives on it. In addition, a modem could be easily added on the top shelf next to the monitor.

For those desiring expanded furniture options, Gusdorf includes a credenza unit, printer stand, corner pieces, and expanders—all which can be attached to each other. These accessories all provide more work space and storage.

Now for one of the highlights of the Gusdorf line—prices. A computer hutch desk sells for approximately \$170. The expanding units such as the credenza sells for \$270. A printer stand is \$140, and expanding table units run from \$40 to \$80. These prices are more than likely discounted by local dealers.

All of the Gusdorf furniture is sturdy and designed to support the equipment placed on it. One of the brochures from Gusdorf shows a monitor and printer on the top portion of the hutch while a keyboard and two disk drives are stored on the desk unit. Each of the assembly holes is reinforced to prevent excessive wear and tear.

Computer purchasers for schools will have to begin looking at computer labs for the future of computers in the curriculum. The Gusdorf line is certainly, at this time, the best answer to an attractive computer lab.

There are two suggestions for the Gusdorf designers that would help computer users. One would be to put a drawer in the desk unit, and two, allow for an option of wheels on all of the furniture instead of flat gliders.

In conclusion the main criteria for computer furniture, design, appearance, storage, expandability, and pricing have all been addressed by Gusdorf. There is no question but that furniture has become the forgotten portion of a computer plan, but through the new Gusdorf line we can all begin planning for when all of our Color Computers in the schools will be moved to a laboratory environment. In addition, home Color users will find that the Gusdorf Compu-Table can house almost all of the necessary equipment in a very small space and in a convenient manner.

---

## Submitting Material To the Rainbow

Contributions to *the RAINBOW* are welcome from everyone. We like to run a variety of programs which will be useful/helpful/fun for other CoCo owners.

Program submissions must be on tape or disk and it is best to make several saves, at least one of them in ASCII format. We're sorry, but we do not have time to key in programs. All programs should be supported by some editorial commentary, explaining how the program works. We're much more interested in how your submission works and runs than how you developed it. Programs should be learning experiences.

We do pay for submissions, based on a number of criteria. Those wishing remuneration should *so state* when making submissions.

For the benefit of those who wish more detailed information on making submissions, please send a SASE to: Submissions Editor, *the RAINBOW*, P.O. Box 209, Prospect, KY 40059. We will send you some more comprehensive guidelines.

Please do not submit programs or articles currently submitted to another publication.

---



# “WANNA FIND OUT WHAT FUN REALLY IS?”

THE KIND OF EXCITEMENT YOU GET OUT OF YOUR SYSTEM DEPENDS ON  
WHAT GAMES YOU PUT INTO IT.

If You Want to Find Out What it's Like to Use your Computer to its Fullest...Then These are the Games  
You'll Need! FOR YOUR TRS-80 COLOR COMPUTER

## Dunkey Munkey

32K EXTENDED BASIC NOT REQUIRED

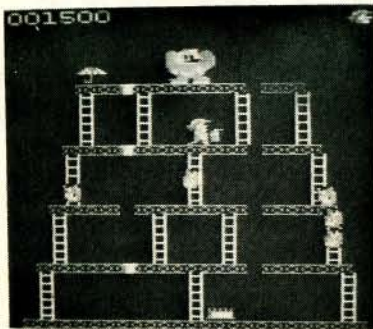

ON THIS SCREEN:  
Pop the Rivets and Fight Fires

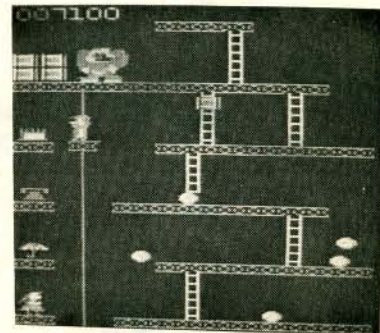

ON THIS SCREEN:  
Jump Barrels and Ride the Elevator

We're sure you already know  
the rules to this game! As game  
progresses so does the difficul-  
ty level.

Cassette ..... \$24.95  
Diskette ..... \$29.95

ULTRA-FAST MACHINE LANGUAGE ■ HIGH RESOLUTION GRAPHICS ■ SPECTACULAR SOUND EFFECTS

## STARFIRE

16K EXTENDED BASIC NOT REQUIRED

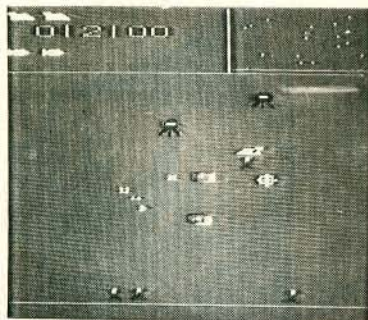

Plays like popular arcade game  
Defender™ including:

- Hyperspace
- Smart Bombs
- Radar Scanner

Cassette ..... \$21.95  
Diskette ..... \$26.95



Give your Color Computer  
a New Image!



## SCREEN - 64

64 Characters X 32 Lines  
Upper & Lower Case

16K EXTENDED BASIC NOT REQUIRED

1. Load in SCREEN-64
2. Type EXEC
3. You're Back in BASIC with a 64 x 32  
Screen plus....

FEATURES:

- Slow/Fast Scroll Selectable
- Window Capabilities
- Text & Graphic on same screen
- Superscript/Subscript
- Reverse Screen/Reverse Video
- No Hardware Modification Needed

Cassette ..... \$19.95  
Diskette ..... \$24.95

**Intellectronics** Ltd

22 Churchill Lane  
Smithtown, N.Y. 11787  
(516) 543-6642

DEALER INQUIRIES INVITED

We pay all shipping. All orders shipped in  
24 hours. N.Y. residents please add sales  
tax. Canadian orders please send M.O. in  
U.S. funds only.



# ColorQuest™

## GAMES

For The TRS-80 Color  
and TDP System 100

Fast Machine Code • Hi-res Color Graphics • Exciting Arcade Action and Sound

## Fembots' Revenge™

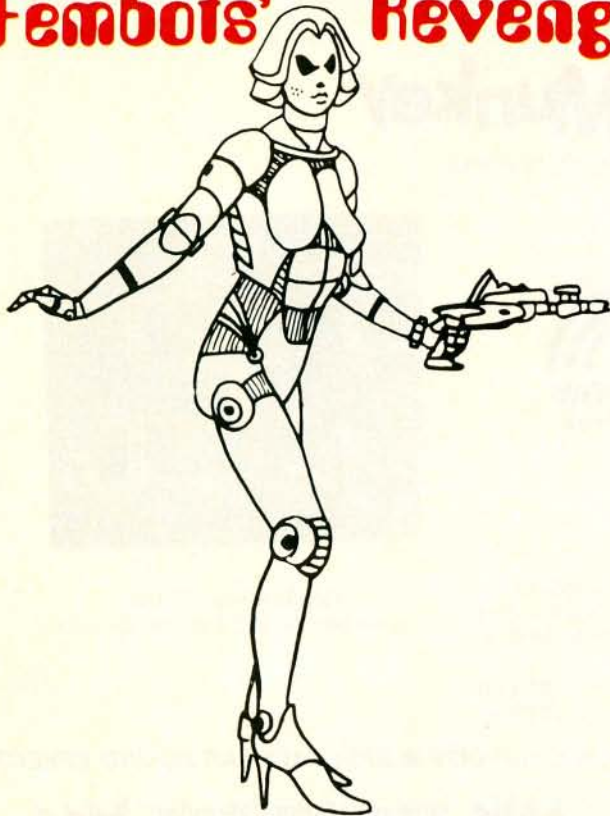

3-D GRAPHIC ADVENTURE

Make love not war? Not with these sultry FEMBOTS! What a tale you'll tell IF you live to tell it! Cold steel never felt so HOT! The color and excitement of ARCADE ACTION combined with the sophistication, intellectual challenge and skill of an ADVENTURE GAME doesn't fully describe this cosmic shoot'em up.

16K Tape \$29.95

32K Disk \$34.95

## BEYOND THE CIMEEON MOON™



by Kevin Herrboldt & Tim Nelson

3-D GRAPHIC ADVENTURE

A dead star . . . A derlict vessel . . . or is it? Trapped within you must venture the corridors; defend yourself against the merciless gauntlet of agents of the machine mind. A real-time, high-res, 3-D science fiction adventure game of mind-blowing magnitude.

16K Tape \$24.95

32K Disk \$29.95

## Adventure Trilogy™



by Kevin Herrboldt & Tim Nelson

3-D GRAPHIC ADVENTURE

Clash steel with thy foe in the arena of gore. Proved worthy, go in quest of the elusive Eye of Dazmor. If ye findest the orb, hast ye the might to ward off skem and the fortitude to restore the Eye? The ultimate high-res, 3-D quest for even the most experienced adventurer!

16K Tape \$24.95

32K Disk \$29.95

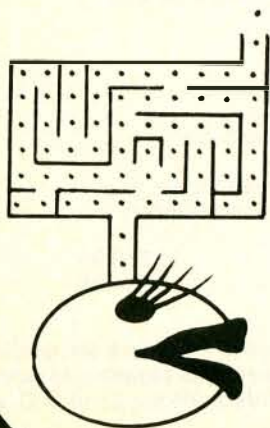

## MS. NIBBLER™

by Tom Czarnecki

The ONLY Ms. game around. A must for your PAC-like game collection.

16K Tape \$19.95

16K Disk \$24.95

TRS-80 is a trademark of Tandy Corp.



For Orders  
ONLY Call  
Toll Free

# 1-800-328-2737

Fast Machine Code • Hi-res Color Graphics • Exciting Arcade Action and Sound

## INTERCEPTOR™

by Scott Snyder

Goes beyond "DEFENDER" and "STARGATE" to offer the most realistic ARCADE simulation possible. Warp speed action, multi-colored terrain and long-range viewer make this game tops.

16K Tape \$19.95  
32K Disk \$24.95



## VEGAS GAMEPAK™

by Dan Nelson

Why fly to VEGAS when you can have a casino at home! The VEGAS GAMEPAK is five action packed games with great graphics & sound. SLOT MACHINE - BLACKJACK - UP AND DOWN THE RIVER - CRAPS & KENO.

16K Tape \$19.95 16K Disk \$24.95

## THE NIBBLER™

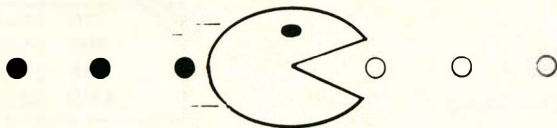

by Tom Czarnecki

Fast paced maze chase game will entertain the entire family.

16K Tape \$19.95  
16K Disk \$24.95

## ColorQuest™

A Division of Softlaw Corp. 612/881-2777  
9072 Lyndale Ave. So., Minneapolis, MN 55420

**AUTHORS' SUBMISSIONS ARE ENCOURAGED**

Available at Dealers everywhere.

If your Dealer is out of stock ORDER DIRECT!



## KOMET-KAZE™

by Tom Czarnecki

Shades of smartbombs and hurtling comets! Defending your planet from invasion was never so challenging. Disruptor fire is your main defense against the fierce alien attacks.

16K Tape \$19.95

32K Disk \$24.95

### ORDERING



Customer service and product support call (612) 881-2777  
Make checks or money orders payable to Nelson Software Systems. Personal checks allow 3 weeks.  
MAIL ORDERS: \$2.00 U.S. Shipping (\$4.00 CANADA \$10 OVERSEAS) Add \$2.00 for C.O.D.  
**ORDERS SHIPPED SAME DAY!**

# TWO ILLUSIONS

## Optical Illusions

By D. and R. Delbourgo

The eye is easily deceived. Psychologists will tell you that our perception of shape is noticeably influenced by the geometry and character of the surroundings: nowhere is this more apparent than in the most famous optical illusions. The listing below contains a number of such illusions (except for the checkered spirals and endless stairs) for your amusement. The CoCo can score over the textbook demonstrations in that the shapes can be presented alternately, with and without perturbation from the surrounds. Because highest resolution is essential, this means that all graphics pages are used up, and unfortunately, this leaves little room for the program itself.

In spite of severe compression we have been incapable of squeezing all the material into 16K, but 32K is well and truly ample. Therefore, for those of you with 16K machines, we suggest that you delete lines 47-70, 80-82, and lines 10, 18-22 from the total listing and call this your first program. Then (from the whole listing again) delete lines 13-17, 24-46 and 3-7, 76-79 and call this your second program.

See how well your eyes stand up to the tests and experiment with the programs by shifting and distorting the basic shapes relative to their settings—another piece of flexibility that comes by courtesy of the TRS-80C.

```

23 044E
40 0735
65 0BBC
END 0EFE
    
```

The listing:

```

1 DIMA(8):DIMB(14)
2 CLS0:C=159:FORJ=0TO11:FORK=0TO
480STEP32:POKE1034+J+K,C:NEXTK,J
:FORJ=1TO3:POKE1446+J,C:POKE1461
+J,C:NEXTJ
3 C=128:FORJ=1TO6:POKE1194+32*J,
C:POKE1205+32*J,C:NEXTJ:POKE1259
,C:POKE1268,C
4 DATA1029,1030,1049,1050,1065,1
078,1260,1267
5 FORJ=1TO8:READA(J):POKEA(J),15
6:NEXTJ
6 DATA1291,1292,1299,1300,1321,1
322,1333,1334,1415,1416,1417,143
    
```

(Continued on next page)

## Optical 2

By Norman Latner

Optical illusions are always fascinating. First you see it one way and then another, or your eye is led to a seemingly impossible situation. Both of these effects appear in this graphics program which I call *Optical 2*. I'm sure you'll enjoy looking at them and listening to the Mozart selection which accompanies the first illusion. P Mode 4 graphics are used to give smooth diagonals, while the black/white color set with red/blue "fringing" add to the clean, crisp visual look.

The program breaks down in the following way. Lines 10 to 80 display the title, with alternating colors and sound. Line 90 sets the mode to 4, the screen to 1,1 and clears the graphics screen. The first illusion is drawn in lines 100 to 240 using the *LINE* instruction throughout. The music, in lines 250 to 420, is assembled in the form of strings, so that musical phrases can be easily repeated using the *PLAY* command. This section also contains two *PAINT* lines which change the background from black to white for another interesting visual effect. Finally, lines 430 to 510 draw the second illusion, again using the *LINE* instruction.

If you're like me, you may be a little reluctant to key in a program unless you know it's worth the effort. Although I can't give you any guarantees, the program is structured such that you can enter it in sections. The minimum entry would be lines 90 to 240 which will display the first illusion with a black background. You will have to add a temporary line: 245 GO TO 245. This prevents a return to the text screen. If you like what you see, add lines 430 to 510 for the second illusion. Line 245 should now be changed to: 245 FOR T = 1 TO 2500: NEXT T. This holds the first picture on the screen for a few seconds. To complete the program from this point, just add the missing lines, delete line 245 and enjoy.

```

110 01D0
180 046E
240 07BF
END 0B3D
    
```

The listing:

```

10 'OPTICAL2 - NORM LATNER-JAN 8
3*****
*
20 CLEAR5000:CLS0
30 FORX=1TO5:PRINT @ 204,"OPTICA
L";:PRINT @ 267,"ILLUSIONS";
40 FORT=1TO200:NEXTT:SOUND10*X,2
50 POKE359,13:SCREEN0,1
60 FORT=1TO200:NEXTT:SOUND35*X,2
70 SCREEN0,0:NEXTX
80 POKE359,126
90 PMODE4:PCLS:SCREEN1,1
100 LINE(71,52)-(71,27),PSET:LIN
    
```

(Continued on Page 31, Col. 2)



```

0,1431,1432
7 FORJ=1T014:READB(J):POKEB(J),1
47:NEXTJ
8 PCLEAR8:PRINT@7,"OPTICAL ILLU
SIONS";:PRINT@335,"BY";:PRINT@42
6,"r&d.delbourgo";:PRINT@456,"15
,willowdene av.":PRINT@481,"hob
art,tasmania, australia7005";:PL
AY"L2003CEG04C03GEC":GOSUB73
9 CLS0:PRINT@39,"OPTICAL ILLUSIO
NS";:PRINT@101,"(1) MULLER-LYER
";:PRINT@133,"(2) ZOLLNER L
INES ";:PRINT@165,"(3) POGGEN
DORFF ";:PRINT@197,"(4) PON
ZO-EHRENSTEIN ";:PRINT@229,"(5)
HERING-WUNDT ";
10 PRINT@261,"(6) EBBINGHAUS
";:PRINT@293,"(7) PINCUSHION
EFFECT";:PRINT@325,"(8) ORBISON
";:PRINT@357,"(9) HERIN
G-SPRINGER ";:PRINT@389,"(0) IM
POSSIBLE SHAPES";
11 PRINT@451,"PRESS YOUR CHOICE
NUMBER ";:PRINT@483,"PRESS R TO
RETURN TO MENU";
12 I$=INKEY$:IFI$=""THEN12
13 IFI$="1"THEN24

```

```

14 IFI$="2"THEN30
15 IFI$="3"THEN35
16 IFI$="4"THEN39
17 IFI$="5"THEN42
18 IFI$="6"THEN47
19 IFI$="7"THEN52
20 IFI$="8"THEN55
21 IFI$="9"THEN58
22 IFI$="0"THEN62
23 GOTO12
24 GOSUB71:LINE(78,75)-(178,75),
PSET:LINE(78,125)-(178,125),PSET
25 DRAW"BM78,75C0H8BD16E8":DRAW"
BM178,75C0E8BD16H8"
26 DRAW"BM86,125C0BU8G8F8":DRAW"
BM170,125C0BU8F8G8":GOSUB73
27 GOSUB75:DRAW"BM78,75C1H8BD16E
8":DRAW"BM178,75C1E8BD16H8"
28 DRAW"BM86,125C1BU8G8F8":DRAW"
BM170,125C1BU8F8G8":GOSUB73
29 GOSUB75:GOTO24
30 GOSUB71:GOSUB76
31 FORJ=0T0128STEP64:FORK=J+8T01
84STEP8:LINE((K-J)*4/3-10,K)-((K
-J)*4/3+10,K),PSET:NEXTK:FORK=8T
0184-J STEP8:LINE((K+J)*4/3-10,K
)-((K+J)*4/3+10,K),PSET:NEXTK
32 FORK=J+40T0184STEP8:LINE(K*4/
3,K-J-40)-(K*4/3,K-J-24),PSET:NE

```

EDUCATIONAL SOFTWARE  
For the Color Computer  
and TDP 100

## TOM MIX SOFTWARE

3424 College N.E.  
Grand Rapids, MI 49505  
(616) 364-4791

**CLOCK**-With the ever increasing use of digital clocks, more and more young people are unpracticed in the use of the "ANALOG" clocks. You remember those, the ones with the hands. This program will attempt to teach the relationship between the two types of clocks.

REQUIRES 16K EXT. BASIC \$14.95

**SPELLING TEST** is designed to give a standard oral spelling test using the audio track of the computer's tape recorder to dictate test words and sample sentences. Student responses are typed on the keyboard and checked by the computer. Results are displayed on the screen and (if connected) on a printer.

REQUIRES 16K EXT. BASIC \$19.95

**MATH DRILL** is a program designed to help children to practice addition, subtraction, multiplication, and division skills on the COLOR COMPUTER. It has several features that make its use particularly attractive.

- Up to 6 students may use the program at the same time.
- Answers for addition, subtraction and multiplication are entered from right to left, just as they are written on paper.
- Commas may be included in the answers.
- Partial products for the multiplication problems may be computed on the screen.
- Division answers that have a remainder are entered as a whole number followed by the letter "R" and the remainder.
- There are ten, user modifiable, skill levels.
- A "SMILEY FACE" is used for motivation and reward. Its size increases relative to the skill level.
- Skill levels automatically adjust to the student's ability.
- A timer measures the time used to answer each problem and the total time used for a series of problems.
- After a problem has been answered incorrectly the correct answer appears under (above in division) the incorrect answer.

REQUIRES 16K EXT. BASIC \$19.95

**WORD DRILL** is designed to give a multiple choice vocabulary quiz. Words and definitions are entered into the program from the keyboard or from a tape file. The computer displays a randomly chosen definition and eight word choices. The student must enter his response before a built in timer reaches zero.

REQUIRES 16K EXT. BASIC \$19.95

**EDUCATIONAL PACKAGE — SPELLING TEST —  
WORD DRILL — MATH DRILL — ESTIMATE —  
ALL FOR — \$69.95**

**ESTIMATE** is a program designed to help children to practice estimating the answers to addition, subtraction, multiplication and division problems on the COLOR COMPUTER. It has many features that make its use particularly attractive:

- Up to 5 students may use the program at the same time.
- There are 5, user modifiable, skill levels.
- The acceptable percent error may be changed as a student's skill improves.
- A timer measures the number of seconds used to answer each problem and the total time used for a series of problems.
- If a problem has been answered incorrectly, the student is told the percent error and asked to try again.
- If a problem is answered incorrectly a second time, the student is told the correct answer and the range of acceptable answers is displayed.
- A report is given at the end of each set of problems that includes the number of problems done, the number of problems answered correctly on the first try and the average percent error.
- The (BREAK) key has been disabled so that a child will not inadvertently stop the program from running.

16K EXT. BASIC \$19.95

**TEACHERS' DATABASE** is a program designed to allow a teacher to keep a computerized file of information about his/her students. There are many features that make this program particularly attractive.

- Information on as many as 100 students (or more) may be in the computer at one time.
- Each student may have as many as 20 (or more) individual items of data in his/her record.
- The program will run from cassette or disk.
- Cassette and disk files are completely compatible.
- The program is menu driven.
- Records may be easily changed, deleted, combined or added.
- Information about students may be numerical or text.
- Records may be quickly alphabetized.
- Records may be sorted by various criteria.
- Records may be reordered (ranked) based on test scores or other data.
- Data displayed during a sort may be printed on a printer or saved on disk or cassette as a new file.
- A full statistical analysis of data may be done and sent to the printer.
- Student test scores may be weighted.

32K EXT. BASIC TAPE \$39.95 DISK \$42.95



• ADD \$1.00 POSTAGE & HANDLING • TOP ROYALTIES PAID •  
MICHIGAN RESIDENTS ADD 4% SALES TAX • LOOKING FOR NEW SOFTWARE

```

XTK:FORK=8TO152-J STEP8:LINE(K*4
/3,K+J+24)-(K*4/3,K+J+40),PSET:N
EXTK:NEXTJ
33 GOSUB72:GOSUB76
34 GOSUB74:GOSUB75:GOTO34
35 GOSUB71:GOSUB77
36 LINE(167,38)-(193,146),PSET,B
F:LINE(203,38)-(229,146),PSET,BF
:LINE(45,38)-(71,146),PSET,BF
37 GOSUB72:GOSUB77
38 GOSUB74:GOSUB75:GOTO38
39 GOSUB71:FORI=0TO96STEP16:LINE
(0,I)-(256,96),PSET:LINE-(0,192-
I),PSET:NEXTI:GOSUB78
40 GOSUB72:GOSUB78
41 GOSUB74:GOSUB75:GOTO41
42 GOSUB71:GOSUB79:GOSUB73
43 FORI=0TO256STEP32:LINE(I,0)-(
256-I,192),PSET:NEXTI:FORJ=15TO6
0STEP15:LINE(0,J)-(256,192-J),PS
ET:LINE(0,192-J)-(256,J),PSET:NE
XTJ
44 GOSUB72:GOSUB79
45 FORI=0TO256STEP16:LINE(128,0)
-(I,96),PSET:LINE-(128,192),PSET
:NEXTI
46 GOSUB74:GOSUB75:GOTO46
47 GOSUB71:GOSUB80
48 CIRCLE(88,76),7,0:CIRCLE(88,1

```

```

16),7,0:FORX=0TO32STEP32:FORY=0T
O20STEP20:CIRCLE(72+X,86+Y),7,0:
NEXTY,X
49 CIRCLE(168,64),15,0:CIRCLE(16
8,128),15,0:FORX=0TO52STEP52:FOR
Y=0TO30STEP30:CIRCLE(142+X,81+Y)
,15,0:NEXTY,X
50 GOSUB72:GOSUB80
51 GOSUB74:GOSUB75:GOTO51
52 GOSUB71:GOSUB81:GOSUB73
53 GOSUB72:FORR=1TO10:CIRCLE(128
,96),150*R/(9+R):NEXTR:GOSUB81
54 GOSUB74:GOSUB75:GOTO54
55 GOSUB71:GOSUB82:GOSUB73
56 GOSUB72:FORI=0TO10:LINE(128,7
*I)-(7*I,192-4*I),PSET:LINE-(128
,150-7*I),PSET:LINE-(256-7*I,192
-4*I),PSET:LINE-(128,7*I),PSET:N
EXTI:GOSUB82
57 GOSUB74:GOSUB75:GOTO57
58 GOSUB71:FORX=5TO250STEP14:FOR
Y=5TO185STEP14
59 LINE(X-2,Y-2)-(X+2,Y+2),PSET,
BF:LINE(X+5,Y+5)-(X+9,Y+9),PSET,
BF:NEXTY,X:GOSUB73
60 GOSUB72:FORX=5TO250STEP14:FOR
Y=5TO185STEP14:LINE(X-4,Y-4)-(X+
4,Y+4),PSET,BF:NEXTY,X
61 GOSUB74:GOSUB75:GOTO61
62 GOSUB71:LINE(76,48)-(246,48),
PSET:LINE-(246,68),PSET:LINE-(76
,68),PSET:LINE(246,68)-(176,148)
,PSET:LINE-(6,148),PSET
63 LINE(6,128)-(156,128),PSET:LI
NE-(192,88),PSET:LINE-(40,88),PS
ET:LINE(40,108)-(156,108),PSET:L
INE-(176,88),PSET:LINE(156,108)-
(156,128),PSET
64 CIRCLE(76,58),5,0,2:CIRCLE(40
,98),5,0,2:CIRCLE(6,138),5,0,2
65 GOSUB72:LINE(129,101)-(104,89
),PSET:LINE-(63,108),PSET:LINE-(
56,50),PSET:LINE-(95,32),PSET:LI
NE-(104,89),PSET
66 LINE(91,106)-(109,115),PSET:L
INE-(118,179),PSET:LINE-(163,158
),PSET:LINE-(156,94),PSET:LINE-(
109,115),PSET
67 LINE(130,104)-(128,80),PSET:L
INE(89,96)-(93,121),PSET:LINE(95
,32)-(168,62),PSET:LINE(118,179)
-(49,139),PSET
68 LINE(160,128)-(177,122),PSET:
LINE-(168,62),PSET:LINE-(128,80)
,PSET:LINE-(156,95),PSET:LINE(58
,72)-(41,81),PSET:LINE-(49,138),
PSET:LINE-(92,121),PSET:LINE-(63
,108),PSET
69 LINE(58,72)-(41,81),PSET:LINE

```



**→ BOOKS & PROGRAMS ←**  
**ASSEMBLY LANGUAGE GRAPHICS**  
**for the TRS-80 Color Computer**  
**by DON & KURT INMAN**

280 pages \$14.95 + \$1.25 postage & handling

**→ SOFTWARE 16K EXTENDED ←**  
**New!!! CRYSTAL REVENGE \$16.95**

HI-RES Space War game. The first fully controlled color in PMODE 4! You must defend the CRYSTAL HOME world from the robot attackers. Planet and multicolor attackers remain the same color every game.

**STARFIRE \$18.95**

Great machine language version of Defenders. Highly rated in the Rainbow. Fast action! By Intellectronics

Software Authors Wanted-Highest Royalties Paid

**\$1.25 Per Order**  
**Postage &**  
**Handling**

All Orders Receive  
10% Voucher On Order



**OWL-WARE**

P.O. Box 116B  
Mertztown, PA.  
19539

PA. Res. Include 6% Tax



DEALERS INQUIRES INVITED



```

-(49,138),PSET:LINE-(92,121),PSE
T:LINE-(63,108),PSET
70 GOSUB74:GOSUB75:GOTO70
71 PMODE4,1:PCLS1:SCREEN1,1:COLO
R0,5:RETURN
72 PMODE4,5:PCLS1:SCREEN1,1:COLO
R0,5:RETURN
73 FORT=1TO2000:NEXTT:RETURN
74 FORP=1TO5STEP4:PMODE4,P:SCREE
N1,1:FORT=1TO2000:NEXTT,P:RETURN
75 IFINKEY$="R"THEN9ELSERETURN
76 FORI=0TO192STEP32:LINE(I*4/3,
0)-(256,192-I),PSET:LINE(0,I)-(2
56-4*I/3,192),PSET:NEXTI:RETURN
77 LINE(18,22)-(98,162),PSET:LIN
E(158,22)-(238,162),PSET:RETURN
78 CIRCLE(168,96),31,0:CIRCLE(88
,96),31,0:LINE(120,66)-(136,126)
,PSET,B:LINE(200,66)-(216,126),P
SET,B:RETURN
79 LINE(0,72)-(256,120),PSET,B:L
INE(0,0)-(256,192),PSET,B:RETURN
80 CIRCLE(88,96),10,0:CIRCLE(168
,96),10,0:RETURN
81 LINE(88,56)-(168,136),PSET,B:
RETURN
82 CIRCLE(128,96),40,0:RETURN

```



(Continued from Page 28)

```

E(71,27)-(96,14),PSET:LINE(96,14
)-(119,27),PSET:LINE(119,27)-(11
9,40),PSET:LINE(119,40)-(108,46)
,PSET:LINE(108,46)-(108,72),PSET
110 LINE(108,59)-(96,64),PSET:LIN
E(96,64)-(71,52),PSET:LINE(71,2
7)-(96,40),PSET:LINE(96,40)-(119
,27),PSET:LINE(96,40)-(96,64),PS
ET
120 LINE(84,58)-(71,64),PSET:LIN
E(71,64)-(71,90),PSET:LINE(71,90
)-(96,103),PSET:LINE(96,103)-(11
9,90),PSET
130 LINE(119,90)-(119,78),PSET:L
INE(108,72)-(132,84),PSET:LINE(1
08,72)-(96,78),PSET:LINE(96,78)-
(71,64),PSET
140 LINE(96,78)-(96,103),PSET:LIN
E(84,96)-(71,103),PSET:LINE(71,
103)-(71,128),PSET:LINE(71,128)-
(96,140),PSET
150 LINE(96,140)-(119,128),PSET:
LINE(119,128)-(119,103),PSET:LIN
E(119,103)-(108,96),PSET:LINE(96
,116)-(96,140),PSET
160 LINE(119,103)-(96,116),PSET:
LINE(96,116)-(71,103),PSET:LINE(
84,134)-(71,141),PSET:LINE(71,14

```

# WORD PROCESSOR for only \$9.95! What?

Yes! That's right, because we want to create some excitement with an introductory offer you can't pass up — a professional quality full screen oriented word processor that would be a bargain at \$50. It's a good one too. Take a look at what you get.

**WORDMASTER's FULL SCREEN-ORIENTED EDITOR** allows you to move the cursor anywhere in your text using the up, down, right and left arrows. Do this one character at a time or by line or page. Insert, delete or replace text at the cursor watching your changes as you make them. Delete or move blocks of text from one place to another. Merge in text from other files.

**AUTOMATIC CARRIAGE RETURN** after last complete word on each line; with this and **AUTOMATIC PAGE FEED** you don't have to worry about where a line or page ends — just type!

**WORD MASTER** runs on a **16K, 32K, or 64K COLOR COMPUTER**, taking advantage of all available memory. Use it with **DISK OR CASSETTE** based systems. **EXTENDED BASIC IS NOT REQUIRED.**

**EASY TO UNDERSTAND MANUAL** has you comfortably using **WORDMASTER** in minutes. It is a **USER-FRIENDLY MENU-DRIVEN SYSTEM** with single letter commands. Check any command without having to refer to the manual with the **HELP SCREEN.**

**10 PROGRAMMABLE FUNCTION KEYS** allow easy insertion of frequently used words or phrases.

**WORKS WITH ANY PRINTER.** Take full advantage of your printer's special functions such as variable character size and emphasized characters with **EASY EMBEDDING OF PRINTER CONTROL CODES.**

**GLOBAL SEARCH** function lets you quickly locate specific strings for replacement or deletion.

Customize form letters or standard text with **WORDMASTER's EMBEDDED PAUSE** feature. Just "fill in the blanks" when your printer pauses for a personalized appearance.

**LIMITED MULTI-TASKING** feature lets you print one file while editing another.

In addition to regular text you can use **WORDMASTER** to **CREATE BASIC PROGRAMS** with the convenience of full-screen editing.

**OTHER FEATURES** include easy setting of left, right, top and bottom margin, printer line width, and lines per page. Also auto repeat keys, auto line centering, auto page numbering and choice of display color formats.

And, perhaps one of the best features, but one that won't last long, is **WORDMASTER's SUPER LOW INTRODUCTORY PRICE OF \$9.95.** At this price you can't go wrong. Buy it today!

**TO ORDER** send \$9.95 for cassette version or \$14.95 for disk version plus \$2.50 shipping (Calif. residents add 6% sales tax) to: **PYRAMID DISTRIBUTORS, 527 HILL ST., SANTA MONICA, CA 90405 (213) 399-2222.**

# WORDMASTER \$14.95 Disk \$9.95 Cassette

1)-(71,167),PSET  
 170 LINE(71,167)-(96,180),PSET:LINE(96,180)-(119,167),PSET:LINE(119,167)-(119,141),PSET:LINE(119,141)-(108,134),PSET  
 180 LINE(119,154)-(132,160),PSET:LINE(132,160)-(156,148),PSET:LINE(156,148)-(156,122),PSET:LINE(156,122)-(132,110),PSET:LINE(132,110)-(119,116),PSET:LINE(132,160)-(132,134),PSET  
 190 LINE(156,136)-(167,141),PSET:LINE(167,141)-(190,128),PSET:LINE(190,128)-(190,103),PSET:LINE(190,103)-(167,91),PSET:LINE(167,91)-(144,103),PSET:LINE(144,103)-(167,116),PSET  
 200 LINE(167,116)-(167,141),PSET:LINE(144,103)-(144,116),PSET:LINE(167,116)-(190,103),PSET:LINE(190,116)-(202,122),PSET:LINE(202,122)-(226,110),PSET:LINE(226,110)-(226,84),PSET:LINE(226,84)-(202,72),PSET  
 210 LINE(202,72)-(177,84),PSET:LINE(177,84)-(177,96),PSET  
 220 LINE(177,84)-(202,98),PSET:LINE(202,98)-(226,84),PSET:LINE(2

02,98)-(202,122),PSET:LINE(190,66)-(190,78),PSET:LINE(190,66)-(167,53),PSET:LINE(167,53)-(144,66),PSET:LINE(144,66)-(144,90),PSET:LINE(144,90)-(156,96),PSET  
 230 LINE(144,66)-(167,78),PSET:LINE(167,78)-(190,66),PSET:LINE(167,78)-(167,91),PSET:LINE(132,84)-(144,78),PSET:LINE(156,59)-(156,46),PSET:LINE(156,46)-(132,33),PSET:LINE(132,33)-(119,40),PSET:LINE(108,46)-(132,59),PSET  
 240 LINE(132,59)-(156,46),PSET:LINE(132,59)-(132,84),PSET:LINE(71,141)-(96,154),PSET:LINE(96,154)-(96,180),PSET:LINE(96,154)-(119,141),PSET:LINE(119,128)-(132,134),PSET:LINE(132,134)-(156,122),PSET  
 250 A\$="V1003L8F03L8G03CP10003C"  
 260 B\$="03L8D03L8F02B-P100B"  
 270 C\$="L8A03L8C02FP100E"  
 280 D\$="L2EF"  
 290 E\$="V20L8CL8EGP100G"  
 300 F\$="L8CL8FAP100A"  
 310 G\$="L8CL8EL8GB-P100AP100"  
 320 H\$="L2AV15G"  
 330 I\$="V1003L8C03L8E-02AP100AL8B-03L8D02GP100GL8A03L8C02F+P100F+L2F+G"  
 340 J\$="V20L8B-03L8D02GP10002GL8A03L8C02FP10002F"  
 350 K\$="L8GB-EP100EP100L2EV15E"  
 360 L\$="V15L2AV10G"  
 370 PLAYA\$+B\$+C\$+D\$+E\$+F\$+G\$+H\$  
 380 PAINT(128,96),5,5  
 390 PAINT(28,90),5,5  
 400 PLAYI\$+J\$+K\$+A\$  
 410 PLAYG\$+L\$  
 420 PLAYA\$+B\$+C\$+D\$  
 430 PCLS:LINE(38,48)-(180,48),PSET:LINE(38,64)-(168,64),PSET:LINE(168,64)-(168,80),PSET  
 440 LINE(168,80)-(70,80),PSET:LINE(168,80)-(184,96),PSET:LINE(200,96)-(70,96),PSET  
 450 LINE(92,112)-(244,112),PSET:LINE(244,112)-(244,128),PSET:LINE(244,128)-(92,128),PSET  
 460 LINE(244,112)-(180,48),PSET:LINE(152,48)-(200,96),PSET:LINE(204,72)-(236,72),PSET  
 470 LINE(236,72)-(252,88),PSET:LINE(252,88)-(252,96),PSET:LINE(252,88)-(220,88),PSET:LINE(252,96)-(228,96),PSET  
 480 CIRCLE(38,56),8  
 490 CIRCLE(70,88),8  
 500 CIRCLE(92,120),8  
 510 GOT0510

## New! For Your Color Computer FROG-TREK

(the arcade game)



You may be able to guide your frog through 6 lanes of rush hour traffic, but that isn't enough! You must also cross the river by jumping on logs and turtles to get Froggie safely to his home on the other side. But watch out for the snake! And don't jump on the industrial waste.

A great M/L game at a great price \$14.95. Uses hi-resolution graphics and requires 16K. Arrows on keyboard move frog- no joy-sticks required.

Send check or money order for \$16.50 (includes shipping) to:

**OELRICH PUBLICATIONS**

**4040 N. Nashville**

**Chicago, IL 60634**

**CALL TOLL FREE TO ORDER**

**800-621-0105**

**MASTERCARD AND VISA ACCEPTED**





# Searching for Service? It's Here.

Color Computer

TRS-80  
HARDWARE & SOFTWARE

Model III

## 13% OFF

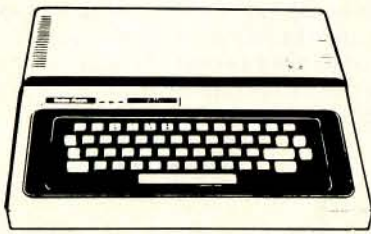

**13% OFF LIST PRICE**



**13% OFF LIST PRICE**

FEATURING THESE ITEMS:

VERBATIM DISKS.....	\$27.95
ELEPHANT DISKS.....	\$25.00
WICO COMMAND CONTROL JOYSTICK.....	\$29.95
WICO COMMAND CONTROL ADAPTER.....	\$19.95

ALSO SOFTWARE BY:

SPECTRAL ASSOCIATES • MARK DATA  
PRICKLY PEAR • TOM MIX • ANTECO

**TOLL FREE  
1-800-251-5008**

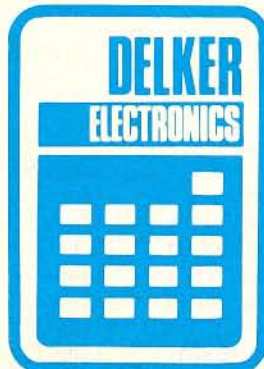

P. O. BOX 897  
GILSVILLE FAMILY CENTER  
SMYRNA, TENNESSEE 37167  
615-459-2636  
NASHVILLE, TENNESSEE 254-0088



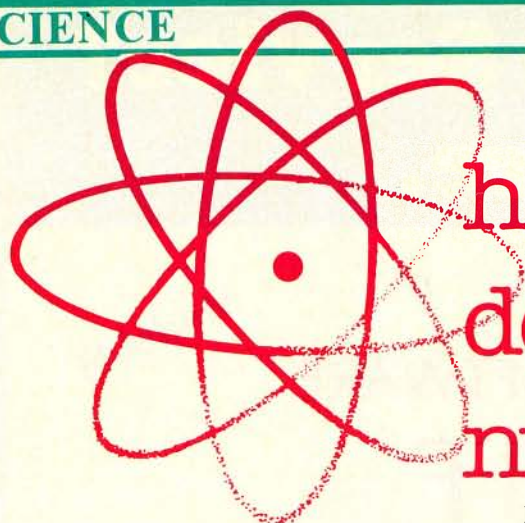

# half-life demonstration of nuclear decay

By David C. Lengyel

The concept of half-life is widely taught in several fields of physical science. It is used to explain the rate at which various unstable atomic nuclei decay or change by emitting particles and energy and are thus transformed into different nuclei. For example, uranium <sup>238</sup> is unstable and changes through nuclear decay into lead. Not all of the original nuclei change at once, however. In fact, this is far from what actually happens. The decay of any individual unstable nuclei is a random event, and thus impossible to predict with any degree of accuracy. In the case of uranium <sup>238</sup>, we do know that it takes  $4.5 \times 10^9$  years for one-half of the nuclei to decay to become lead. After another  $4.5 \times 10^9$  years, one-half of the remaining uranium <sup>238</sup> nuclei decay and after a third interval of  $4.5 \times 10^9$  years, another one-half of the uranium <sup>238</sup> nuclei decay and so on. Therefore, the time interval in which one-half of a sample of unstable atomic nuclei decays is called the half-life. Each type of radioactive substance has its own half-life which can vary from a fraction of a second to billions of years.

This program for the Color Computer illustrates the random process of nuclear decay and shows how, through a random process, the half-life comes to be. Initially, 144 blue rectangles are set on the screen, using the low resolution set-reset procedure. Extended Basic's TIMER function is used as a time counter. Each blue dot (rectangle) represents an unstable atomic nuclei of a particular imaginary element. The X and Y coordinates of each dot are stored in arrays. The computer then looks at each point individually and through the RND function decides whether or not the nuclei will decay. If it does decay, then the dot is changed to red. When one-half of the nuclei have decayed, 72 in this case, then the half-life interval is displayed. When half of the remaining nuclei decay, the second half-life time is shown, and so on, up to the fourth half-life.

When the program is *RUN*, you are asked to *INPUT* a time factor. This can be a number from 2 to about 30. Higher numbers may cause the TIMER to reset. A small number produces a shorter half-life period.

The first number displayed at the right of the screen is identified as the half-life and the subsequent displays are labeled second, third and fourth half-life. These are cumulative *timer* values and should be even multiples of the half-life (two times, three times and four times). The first half-life is displayed when 72 nuclei decay, the second when 36 more decay, the third when 18 more decay and the fourth when nine more decay.

Since 144 points do not represent a truly large sample size, the results do not always give half-life periods that are the

same. For example, if the first half-life is at 250 counts (about 25 seconds) then the second should be at 500, the third at 750 and the fourth at 1000. The actual results will vary but do come close enough. Actually, the variability can lead to some interesting classroom discussions on the idea of random events.

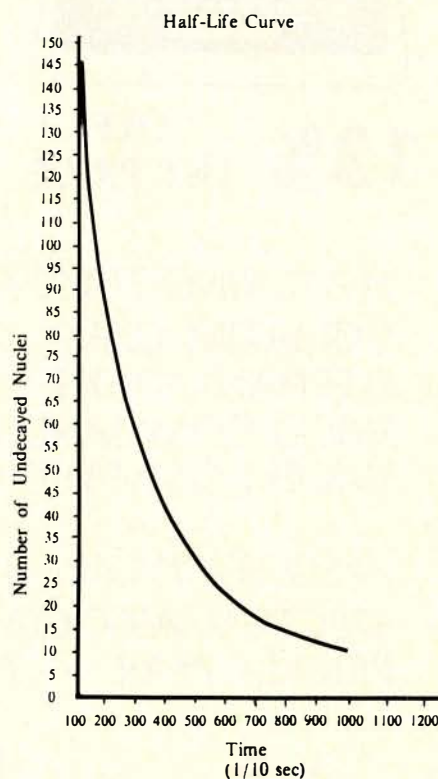

Lines 50-128 Stores point locations in arrays X and Y  
 Lines 140-160 Asks for time intervals  
 Lines 175-200 Displays all points as blue  
 Line 210 Sets TIMER to 0  
 Line 220 Displays time counts (about one-tenth seconds)  
 Line 230 Selects a random point to check  
 Line 235 Checks if point already set  
 Line 237 Decides if decay takes place  
 Lines 240-257 Checks for half-life intervals



The listing:

104 0246  
200 050A  
END 074D

```
40 ' BUILD ARRAYS
50 DIM X(144),Y(144)
60 FOR I=1 TO 144
70 READ X(I),Y(I)
80 NEXT I
90 DATA 0,1,5,1,10,1,15,1,20,1,2
5,1,30,1,35,1,40,1,45,1
92 DATA 0,3,5,3,10,3,15,3,20,3,2
5,3,30,3,35,3,40,3,45,3
94 DATA 0,5,5,5,10,5,15,5,20,5,2
5,5,30,5,35,5,40,5,45,5
100 DATA 0,7,5,7,10,7,15,7,20,7,
25,7,30,7,35,7,40,7,45,7
102 DATA 0,9,5,9,10,9,15,9,20,9,
25,9,30,9,35,9,40,9,45,9
104 DATA 0,11,5,11,10,11,15,11,2
0,11,25,11,30,11,35,11,40,11,45,
11
110 DATA 0,13,5,13,10,13,15,13,2
0,13,25,13,30,13,35,13,40,13,45,
13
112 DATA 0,15,5,15,10,15,15,15,2
0,15,25,15,30,15,35,15,40,15,45,
15
114 DATA 0,17,5,17,10,17,15,17,2
0,17,25,17,30,17,35,17,40,17,45,
17
116 DATA 0,19,5,19,10,19,15,19,2
0,19,25,19,30,19,35,19,40,19,45,
19
120 DATA 0,21,5,21,10,21,15,21,2
0,21,25,21,30,21,35,21,40,21,45,
21
122 DATA 0,23,5,23,10,23,15,23,2
0,23,25,23,30,23,35,23,40,23,45,
23
124 DATA 0,25,5,25,10,25,15,25,2
0,25,25,25,30,25,35,25,40,25,45,
25
126 DATA 0,27,5,27,10,27,15,27,2
0,27,25,27,30,27,35,27,40,27,45,
27
128 DATA 0,29,5,29,10,29,15,29
140 ' INPUT HALF LIFE TIME VARIAB
LE *****
150 CLS:PRINT TAB(7)"ENTER TIME
FACTOR"
160 INPUT H
170 CLS(0)
175 ' *** SET ALL DOTS BLUE ***
180 FOR I=1 TO 144
190 SET(X(I),Y(I),3)
200 NEXT I
205 ' *** MAIN ROUTINE ***
210 TIMER=0
```

```
220 PRINT@493,"TIME="INT(TIMER/6
);
230 I=RND(144)
235 IF POINT(X(I),Y(I))=4 THEN P
RINT@493,"TIME="INT(TIMER/6);:GO
TO240
237 R=RND(H):IF R<>1THEN220 ELSE
N=N+1:PRINT@56,"X="N;:SET(X(I),
Y(I),4):PRINT@493,"TIME="INT(TIM
ER/6);:IF N=144 THEN 370 ELSE 24
0
240 IF N=72 AND F<1 THEN SOUND10
0,1:F=1:PRINT@120,"HALF ";:PRINT
@152,"LIFE ";:PRINT@184,INT(TIME
R/6);
250 IF N=108 AND F<2 THEN SOUND
150,1:F=2:PRINT@216,"2ND HALF";:
PRINT@248,"LIFE ";:PRINT@280,
INT(TIMER/6)
255 IF N=126 AND F<3 THEN SOUND
200,1:F=3:PRINT@312,"3RD HALF";:
PRINT@344,"LIFE ";:PRINT@376,
INT(TIMER/6)
257 IF N=135 AND F<4 THEN SOUND2
50,1:F=4:PRINT@408,"4TH HALF";:P
RINT@440,"LIFE ";:PRINT@472,I
NT(TIMER/6)
330 GOTO220
370 GOTO 370
```



## PRICKLY-PEAR SOFTWARE

QUALITY PROGRAMS FOR YOUR 80C

PROGRAMS REQUIRE 16K EXTENDED BASIC FOR  
TAPE, AND 32K DISK UNLESS OTHERWISE NOTED.

### NEW THIS MONTH

#### The Disk Manager

If you use a disk drive you NEED this program! It does more than any other disk utility. You can use it to rebuild a crashed disk easily - two different ways. You can also print a SUPER DIRECTORY for a disk that contains such information as program size, which granules are used, and the start, end, and execute addresses for machine language programs. It will also print a menu on the screen for a disk in the drive, and when you indicate your choice it will load and either RUN or EXEC the program for you as appropriate. In addition, it codes your files by DATE, and it codes your disks by NAME and NUMBER. And, it creates and maintains a file of all your disks (and the programs on them) which you can sort and print as needed. You can sort a collection of up to 300 disks. Could you use a printed list of EVERY program in your collection, in alphabetical order? This list tells you which disk has the program you need so you can find it easily, and all this is only the beginning. There are so many features we have no space to mention them all. Both the 16K and 32K versions are included, and we suggest you place a copy of the program on every diskette for quick access. You will wonder how you got along without this beauty!! Full, easy to follow instructions. Requires a disk drive. \$29.95

Your Personal check is welcome - no delay. Include \$1.50 shipping for each program ordered. (Shipping free on \$50.00 or larger orders). Az. residents add 6% sales tax. Orders shipped within two days.

Stocked by Quality Dealers, or send order to:

#### PRICKLY-PEAR SOFTWARE

9822 E. Stella Road, Tucson, Arizona 85730, (602) 886-1505

# Homebase: Complex, Versatile Data Management

By Frank J. Esser

The purpose of a database program, or system, is to provide a means to store data in such a manner that the user of the system is not required to know where or how the data is stored. His only concern is that indeed it is stored. To this end, many database systems have been written for large and small computers. Some are easy to use, some are hard to use and then there are some that are downright painful to use. *Homebase* is a program which has been designed to serve as both a database manager and a text/word processor. *Homebase* is written for a 32K Color Computer with Extended BASIC and a disk operating system. The programs are set up to handle the characteristics of either Radio Shack LPVII/LPVIII or Epson printers. I have a Radio Shack LPVII printer and experienced no trouble with it at all.

The entire *Homebase* system comes enclosed in a three-ring binder. The documentation is subdivided by functions with each of the system menus receiving its own divided section. The documentation is clearly laid out and easy to read. The diskette is enclosed in a pocket, specifically designed for this purpose, inside the front cover. Also enclosed is a separate seven-page document which gives a brief overview of the system and the best manner with which to become familiar with it. The documentation was produced on a matrix printer with free use made of the

elongated print and overstrike features. The entire package is very nicely done and is impressive in its format. There are three examples in the first chapter which are designed to help the new user become familiar with the programs. The programs are not hard to use once one becomes familiar with them. But because of the complexity of the operations and the interaction of the commands, it does require a considerable amount of experimentation before one feels comfortable enough to start serious data entry. This degree of experimentation is not unusual for a program of this type. If you are looking for a program you can setup and start entering data into the same day, this is not the one for you. But, if you want a program that will give you the option of user-defined file parameters, report formatting at the time the report is generated, searches through the data base on file defined items, by value, and do not want to worry about excessive disk accesses because you are expanding a sequential file, then this is the program for you. The examples provide a good start, but are lacking in a good explanation of the interaction of the commands used in them. Good documentation is ever so important. It is the communication link between the producer and the user and needs to be clear and to the point. I found the documentation package with *Homebase* to be lacking in only one aspect. On those pages where many options were described, it would have improved the readability if a black line was inserted between each of the option descriptions.

The system is broken down into two distinct sections: the text/word processor section and the database section. I will cover each section individually. The system as a whole leaves something to be desired. It requires that, once the program is run and exited, it cannot be rerun without recycling power. I am hard pressed to determine why a program has to be designed with such constraints. I tried running several of my standard programs and routines after running *Homebase* and all appeared to be in order. But just the warning leaves me with an uncomfortable feeling. I have many years of experience with computer systems in the hardware/software field. One of the major causes of system failures, even in this age of integrated circuits, is unnecessary power cycling. It bothers me when a program is written in a manner that the system is left in such a state that power must be cycled to restore it to a fully usable condition.

The text processing section is menu driven, as is the whole system. The text processor builds a text file by forming a group of not more than 250 text records. Each record may consist of a maximum of 480 characters, 15 lines at 32 characters per line. Each record block is given a name. It is through this name that the blocks can be later recalled. The record block parameters are specified at the time the file is created and are stored with the file for future reference.

The processing functions available offer all the general utilities such as adding, deleting, updating and displaying the records. During the building of a record block, compressed, double width, overstrike, and emphasized printer control codes are available as imbedded characters in the text. The format codes are generated by single key commands and are very easy to use. Also available are new line, new page, stop printing and tab sets. The important point to remember here is that all processing is done at the record block level. You can put a document together in any manner you choose by simply manipulating the record blocks. Individual blocks can be selected, reordered, changed or sorted before printing. All of this can be done without affecting the data stored on disk. Suppose that you wanted to print a document that would consist of record blocks one and five. Using the "select" function, record blocks one and five are collected. Then using the *PRINT*

NEW from

CoCoHut

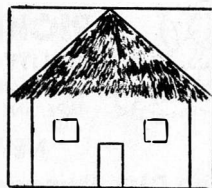

THE ULTIMATE STRATEGY GAME ....

ZARCONIAN

MARBLE

1 or 2 players

Match wits with the computer

16K Ext. Basic required

Cassette 19.95      Disk 24.95

Send check or money order to:

COCO HUT

P. O. BOX 24451

HOUSTON, TX. 77015





# Look What Radio Shack Has In Store for Your TRS-80® Color Disk System

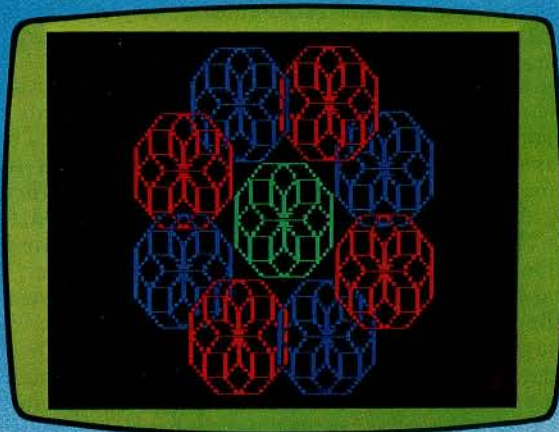

Kids love turtles—especially the kind that draws the designs in our new Color Disk LOGO program. Using our enhanced version of LOGO, children are able to experiment with logical and geometrical relationships at their own pace. They learn by doing, and have fun at the same time. Kids not only learn

## NEW! Color Logo

- "Turtle" Graphics Allow Children To Learn by Hands-On Experimenting
- "Doodle" Mode for Pre-Readers
- "Hatch" Command Creates a Second Turtle for Running Several Programs Simultaneously

how to write programs, but they can investigate structured thinking, multi-tasking, inter-process communication, modular programming, parameter passing, local and global variable, and looping and recursion—all from teaching their turtle how to draw designs on the video screen! No wonder LOGO is a favorite with computer scientists and educational theorists as well as kids! (26-2721, \$99)

## Ask "What If?" With Spectaculator

```

C>          3          4          5
1          BUDGET FOR MAY
2          BUDGET          BUDGETED
3          CATEGORIES          AMOUNT
4
5
6 AUTO          175.00
7 CAR CARE          35.00
8 FOOD          150.00
9 GAS          60.00
10 INSURANCE          15.00
11 RECREATION          75.00
12 RENT          225.00
13
    
```

Here's an "electronic spreadsheet" program that's easy to set up and use, yet does the forecasting, planning and problem-solving you need. Just enter the numbers and formulas—Disk Spec-

traculator will calculate and display the results on command. Enter new figures and it updates every related number. You can run totals of each column and grand total, plus save worksheets to disk for later use. (26-3256, \$59.95)

## Personafile Keeps Records Handy

```

SUBJECT..MY STUFF
TAG.....STEREO

REALISTIC STA 2000. PURCHASED
11/30/88. HOUR 10 SPEAKERS.
PURCHASED 11/30/88 SCT-33 TAPE
RECORDER/PLAYER. PURCHASED 11/
30/88. REALISTIC 5-BAND
EQUALIZER. PURCHASED 12/23/88.

<BREAK> TERMINATES INFO ENTRY
ARROW KEYS MOVE CURSOR
<CLEAR> DELETES LINE
<SHIFT-CLEAR> INSERTS LINE
    
```

pers. With Personafile records are easy to find and recall in just seconds. Allows up to 540 records with up to 250 different subjects. (26-3260, \$59.95)

## Disk SCRIPSIT™ for Word Processing

<pre> Now you can have in- creased capacity to store and access complete programs in large amounts of data with TRS-80 Color Computer. Just add one or more Color Disk drives with Disk Color 540. Check the many advantages! Plus-in Program Pak control allows quick and easy attach- ment of disk drives to you Color Computer! does not require the user to understand an "operating system" or learn an alternate operation mode. Mem=00002 Line=002 001-002         </pre>	<pre> Key Summary: Key(s)          Funct left arrow      Moves cursor 1 character as c r. arrow        Moves cursor r up characters them. up arrow        Moves cursor u down arrow      Moves cursor d Shift u,a.      Moves cursor t         </pre>
--	---

Color Disk SCRIPSIT lets you create correction-free letters, themes and reports right on your video screen. It will display upper and lower case letters and even let you print one document while working on another. (26-3255, \$59.95)

Now available at . . .

# Radio Shack®

The biggest name in little computers®  
A DIVISION OF TANDY CORPORATION

Send me your free TRS-80 Computer Catalog today!

Mail To: Radio Shack, Dept. 83-A-658  
300 One Tandy Center, Fort Worth, Texas 76102

NAME \_\_\_\_\_  
ADDRESS \_\_\_\_\_  
CITY \_\_\_\_\_ STATE \_\_\_\_\_ ZIP \_\_\_\_\_  
PHONE \_\_\_\_\_

Retail prices may vary at individual stores and dealers.  
Special order may be required at some stores.



command, they are printed. You then have the option to discard those blocks just manipulated and start all over again. Or you can add more records to those already selected and repeat the entire process. There are some disadvantages to performing text processing in this manner. If you are familiar with a standard text/word processor, then beware, because *Homebase* does not function in the same manner. Perhaps its biggest drawback is its apparent inability to properly format on the screen how an actual page will look when printed. The program handles upper/lower case in a manner identical to BASIC. That is, lower case characters are represented by reverse video. *Homebase* will create documents of good quality if you are willing to spend the time required to manually format the separate record blocks. There exists what I consider a serious flaw in the printing function. The printing process allows the user to set the right margin. The manual does spell out the rules for handling the right margin. When the right margin is encountered, a new line is started when the word being processed ends. If the word is longer than the document width, then the word is broken and the remainder is carried forward to the next line. The more expensive word processors generally handle this problem by doing a look ahead. If any part of the last word in the present line lies on the right margin it will insert enough double spaces into the line to cause the end of the preceding word to be in the last column. For those printers with proportional spacing, the word processor will adjust the spaces evenly between the words on that line to get the same effect. Some of the less expensive word processors will simply pick up the entire word and carry it forward to the next line. This leaves a more ragged edge, but the document is clearly readable. *Homebase* only has this problem when the right margin is specified to close to the actual form width. Another minor

problem occurs when the print option is exercised and the printer head is not at the home position. It seems that a carriage return (cr) is not sent to the printer prior to the printing of the first record, thus the first line is started wherever the print head was last used and that may not be the left margin. The text processor does perform as advertised and will produce good documentation if you are willing to spend the time required to do so. After years of using a word processor, I do not feel *Homebase* is a good substitute.

The database section of *Homebase* is menu driven as are all elements of the system. For those of you who are not familiar with database managers, I would like to offer a brief explanation of how they function. A database system stores data in a record/field structure, the primary data structure being the file. The secondary structure is the record/field pair. The most commonly used example to explain this relationship is a file cabinet containing sales invoices. The file cabinet is equivalent to the disk file. Each sales invoice in the file is equivalent to a record in the database file. Each separate entity on the sales invoice corresponds to a field in the database record. The customer's name and address could be a field as well as the date, the type and number of items sold. Each record in the database has a name attached to it. In the case of our file cabinet, the customer's last name could become the record name and correspond to a file folder in the cabinet. Seem confusing? Well, the first couple of times around it will be, but don't let it scare you. If I can learn it, anyone can. Now with this information in hand, let's proceed. *Homebase* allows for the definition of 50 fields in each record and a maximum of 250 records per file. The type of definitions which are allowed are:

- A) Amount, treated as a dollar amount
- C) Code, can consist of any five characters
- I) Identification, consists of nine place integer
- O) Other, is a nine digit decimal with two digit decimal places
- D) Date, consists of month/day/year
- P) Phone, consists of area code plus seven-digit phone number
- T) Time, consists of time of day in hours/minutes

The definition of data fields and the actual entry of data are easily mastered if you are familiar with the basic concepts. The real challenge to using a program of this type is to lay out the data fields in such a manner that the data can be easily obtained and used. I have maintained a list of software/hardware/games reviews pertaining to CoCo which have appeared in various publications. The list is getting quite long and hard to manage. Thus, I decided to see if I could get *Homebase* to handle this mass for me. It required about 30 minutes to decide just what fields I wanted to include. The creation of the data file required another 10 minutes. I was able to enter the data at a pretty good clip due to the excellent screens used during this process. Once the data was in, I started processing it according to hardware, software, type of software review, and the magazine it was in. I was surprised at the ease with which I could extract the desired information from database. There is one hooker in the entire process. The "select" function is the command which does the formatting and requires a good deal of experimentation to discover its secrets. But once mastered, everything will fall into place. All the necessary functions are available to completely manage the database, such as adding, deleting, updating, searching and clearing fields and records. Also there is a calculate command which allows adding, subtracting, multiplying and dividing any of the data fields. Also included is a set of utilities which provide all



## PRICKLY-PEAR SOFTWARE

QUALITY PROGRAMS FOR YOUR 80C

PROGRAMS REQUIRE 16K EXTENDED BASIC FOR TAPE, AND 32K DISK UNLESS OTHERWISE NOTED.



### Quality Educational Programming

We have a good selection of sound educational programs for use at home or in school. These programs have been developed by teachers to be easy to use and interesting.

#### Educational Programs:

PREREAD I, II, & III: Teaches the alphabet to preschoolers  
 PHONICS I & II: Teach consonant blends and digraphs  
 MATHPAC I: Arithmetic drill for the elementary school student  
 HOUSEHOLD HELPER: Complete METRIC conversions  
 SPANISH: A complete conversational course

#### Educational Games:

(These were developed to be fun - the education is a happy plus.)

TOPSY TURVY: Forming words out of letters against a timer  
 THE GREAT WORD GAME: Guess your opponent's secret word letter by letter

VIKING!: Become King or Queen by managing your Viking holding wisely, using sound economic principles. One of our most popular games!

Your Personal check is welcome - no delay. Include \$1.50 shipping for each program ordered. (Shipping free on \$50.00 or larger orders). Az. residents add 6% sales tax. Orders shipped within two days.

Stocked by Quality Dealers, or send order to:

**PRICKLY-PEAR SOFTWARE**

9822 E. Stella Road, Tucson, Arizona 85730, (602) 886-1505



the required support functions.

I found *Homebase* easy to use once I got into it and was pleased with the results. Though it is not a full blown data base manager, it most certainly has its applications and is not nearly as costly as its big brothers. I have one suggestion. I found the field descriptors to be too limited and narrow. The addition of a variable length character field would be a definite asset. That, coupled with the three decimal fields, would make *Homebase* a much more versatile package.

I consider *Homebase* to be a program of good quality and design. It is apparent from the documentation and the flow of the programs themselves that a considerable amount of thought went into their design. The menus are very well designed and are laid out in a most appealing manner. As a database program I like *Homebase*. I think its applications are limited only by its user. It can be tailored to fit your requirements within the previously mentioned constraints. For example, it can be used to handle small mailing lists, club rosters, phone lists or your checking account. The point is the program is very versatile and has many good applications. Another strong point is its ability to increase the size of its output file to the maximum, or update existing records without the familiar disk thrashing caused by the expansion of sequential files. The text processing section will indeed provide the user with the ability to produce good documents. However, I found it a little hard to use, but then maybe I'm spoiled by word processors. If you want a text processor capable of generating files for a macro assembler or a basic compiler, *Homebase* will do it for you with ease. If you are looking for a data manager first, then *Homebase* may well be the answer and the text processor becomes an added feature. If you are looking for just a text/word processor only, then I would not recommend *Homebase*. Included with the documentation is a phone number you can call if you have trouble with *Homebase* to receive assistance.

(Homebase Computer Systems, P.O. Box 3448, Durham, N.C., 27702, \$75.00 plus \$5.00 postage and handling)

## Corrections

In Jorge Mir's article, "The Latest Program? Here's A Dating System" (page 58, February 1983 issue), lines one through four of the listing are missing. Of these, three are REM statements, but line 3 is critical:

```
1 ' *** AUTOMATIC DATING ***
2 ' BY: JORGE MIR
3 ' DATE$="10/21/82"
4 '
```

In his article, "Techniques For Plotting Screen Graphics" (page 186, February issue), *Rainbow* contributing editor Don Inman "neglected to include the line which draws the line." To correct Plotter Program #1, readers should insert:

```
1015 LINE (X1,Y1)-(X2,Y2),PSET
```

Also, in the options for program #2 (bottom of righthand column, page 191, *Rainbow* failed to add the "less than" and "greater than" symbols. The lines should read:

```
125 IF N<3 THEN PRINT "I NEED AT
LEAST 3 LINES": GOTO 120
153 IF X(Z)>255 OR X(Z)<0 THEN P
RINT "INPUT OUT OF BOUNDS-TRY AG
AIN":GOTO 150
156 IF Y(Z)>181 OR Y(Z)<0 THEN P
RINT "INPUT OUT OF BOUNDS-TRY AG
AIN":GOTO 150
```



Buy a disk drive for  
your Co-Co that's  
better and saves  
you money!

### TANDON 40trk DISK DRIVES

DRIVE 0 \$449.

DRIVE 1 \$249.

DRIVE 0&1 \$669. (dual case and power supply)

### Double Sided 40trk TANDON Drives

DRIVE 0/1 \$549

DRIVE 2/3 \$349.

DRIVE 0/1/2/3 \$869. (dual case)

WICO COCO TRACKBALL \$69.

WICO JOYSTICK \$24.95

16K CHIP SET \$14.95

64K CHIP SET (8) \$64.

JCAT AUTO/ANSWER MODEM \$139.

Since this ad was formatted in January  
printer prices were expected to go  
down, please call our toll free number  
for the latest pricing and availability.

48K 2 DRIVE MODEL III \$1695.

### 120 Day Warranty

Visa, MasterCard, Money Orders, Personal Checks

Require 3 Weeks, and Wire Transfers.

# COMPUKIT

1-800-231-6671

1-713-480-6000

16206D Hickory Knoll Houston, Texas 77059



## Fallout— The Silent Killer

By Dan Mickle

*Dan Mickle, who wrote this month's cover article, and Steve Lipps, who wrote a number of the routines used in the listings which follow, were both active in Civil Defense during the 1960s when fallout shelters seemed to have their heyday. Dan is a self-professed survivalist, while Steve describes himself as a "hacker and science fiction buff who reads a lot of post-World War III fiction." The two, who operate Circle City Software, of Indianapolis, have written such software as Master Disk System, reviewed in last month's Rainbow.*

The history of man contains one war after another. Thus, I find no reason to believe another war is unthinkable, but rather, given the nature of humans, I personally think it is inevitable. One can conclude from information coming from the Soviet Union that they find even the prospect of a nuclear war not only thinkable but winnable! They have estimated that were they to strike first against us, they would probably kill 90-95% of our population. In my opinion they must feel that our retaliatory counterstrike would only affect a small percentage of their people and perhaps 10 percent of their technology. They have several reasons for such an estimate, but a prime reason is that the Russian people have regular training and monthly scheduled practice sessions of exactly what they will do if an attack comes. Workers who labor at a certain factory would proceed directly to that factory (unless they were already at work) and begin sand-bagging their machine. They are responsible for the safety of that machine. Factories are built decentralized, with separate buildings far enough apart that if one building takes a direct hit, other buildings might suffer minimal damage.

Many Americans take a fatalistic outlook at the next big war. "When it comes, we'll all be killed anyway!" can be heard from many people. Yet, while the initial explosions would kill a lot of people, the radiation which follows would result in many times as many deaths. If our people knew how to protect themselves against the invisible killer, perhaps not as many would die.

My analogy to the fatalistic approach is walking down the middle of a highway, and stating that you don't need to watch out for traffic, because when a large truck hits you, you will be dead anyway ... ridiculous! Obviously a truck need not hit you if you know enough to get to the side of the road and to watch out for trucks and jump out of the way in time.

Fallout radiation need not kill you if you know to "jump out of the way" (seek shelter) *in time*. The *Fallout* program and this article do not constitute a complete training course on how to live through war, but I hope this information will help a few more survive, should war come. The information is as factual as I can make it, and is based on material from the U.S. Government Printing Office at Washington, D.C. should you wish further information. The first listing is the heart of the fallout prediction program, and will run on any 16K extended or disk-extended system. If you have a printer, the program gives you the option of using that printer for your output device. NOTE: Since this is a "high priority" program, the printer utilities patch themselves in and overwrite any other routines you may have residing in high memory. The second part of the program may be *MERGED* in, if you have 32K of memory. It is not an essential part of the program. It is only a high-res drawing of the "cigar shape" of a fallout pattern as a reminder. For those who do not have the time to punch in the program from this listing, the *Fallout* program is available through *Rainbow On Tape*.

If our country were attacked, the enemy would be trying to destroy the United States as a world power. This means that their primary targets would be our military bases, and our nation's capitol. However, many military bases exist near large cities, so those would suffer the same as the primary targets. The larger cities are targeted anyway, due to factories and plants which can be easily converted to wartime equipment production, or natural port areas for staging counterstrikes. Claiming the inaccuracy of enemy targeting computers and rocket control interfaces, it is estimated by some that their bombs may strike many miles from the intended target, through over/undershot. Important targets will get more than one bomb, but even then the unknown element of warhead "fratricide" (a theory stating that the first explosion might destroy the electronics of others in the same area) may spare millions.

**YOU ARE ALIVE.** The wave of missiles has gone off, and you survived the searing heat of the fireball. What's next? *Shock-wave!* The shock travels at the speed of sound outward from the blast, just as thunder follows lightning. It will hit like an extremely powerful earthquake causing buildings within several miles of the blast to be leveled, and lesser damage like shattered windows twenty or more miles out. The initial blast also spreads radiation outward a distance equal to the crosswind value. You will see that if you have a wind speed of zero, the upwind and crosswind values are the same and the fallout would eventually settle in



a circle no greater than the maximum width value. In reality, terrain and other features in your area will affect how large a dose you can expect. A hill sitting between you and the blast will act as a natural barrier which could save your life.

For the sake of an example, let us imagine that a nuclear bomb has just gone off 25 miles away to the north. You were asleep in your bedroom. Your curtains could have just caught fire, but you were not directly in line with the heat from the fireball. You have a choice which depends a lot upon your exact situation at the time. Pull the blankets and covers completely over you head, then you may: 1) stay where you are, 2) crawl to a closet, closing the door, 3) crawl under the bed (not likely for most adults), 4) keeping the covers over you, push up the mattress and crawl under it (not likely for children), 5) if a cellar door is near your bed, crawl there. Roughly calculating the shockwave at five seconds per mile, you figure you have two minutes before the shockwave hits, and things fall in on you. This is the main reason to crawl quickly to the closest place of relative safety. The bathtub, perhaps? If you were outside in the open, a culvert or even a ditch or shallow depression might protect you from the blast. The fireball would probably still be going on when the shocks hit. A ground shock would come first, followed by the air-shock, because a shockwave travels faster through solid objects (the Earth).

Since there would be no electricity to power your Color Computer, you should commit the tables to memory, or at least to paper. You know that the normal wind in your area blows east, going back to the example, and that you are south of the blast. You will be able to guesstimate a 10 megaton blast based on the severity of the blast at this distance (severe, but you made it) and you will know that you are probably now getting in the neighborhood of 50 roentgens per hour. A dosage of 450 roentgens will kill 50 percent of the people exposed to that much. Since radiation is cumulative, you will reach that level in nine hours of exposure, and it will be a slow painful death. However, according to government figures, every three inches of earth you can put between you and the radiation will cut the level in half. Let us say your house is still relatively intact. If you are going to rush going outside to shovel dirt over cellar windows, or up around the foundation, do it now. Grab a rubber raincoat or other easily brushed-off article of clothing. If you don't have a hood, you might tie a plastic trashbag over your head to keep the dust from settling directly on you. Tie a scarf of towel over your mouth. **SPEED IS ESSENTIAL.** You may not be able to draw any water if the pipes were damaged, so you can't wet the rag, but you may have stocked the cellar with a few plastic jugs of drinking water. Stay outside for *as short a time as possible*, but try to seal up any major cracks which will let the dust in directly. Inside the house, drag mattresses and furniture over the spot you will be staying or around a closet, etc. Get into your shelter, breathe through clean towels or clothing, and stay there as long as possible. Remember that the wind could have shifted, putting you into the heart of the hot (3000+ roentgen) zone in which *10 to 12 minutes* of exposure can be enough to kill you. Since the fallout is carried by the air (wind) after the initial blast, the radiation level which started at about 50 in this example, could be 100 within a half hour, 300 within an hour, 1000 within an hour and a half, and 3000 in two hours.

You can see that what you do in the first few minutes might save your life. Even if you are directly in the path of the hottest radiation zone, it could take a couple hours or more to build up to that level. The radiation level drops off rapidly with time. The 3000 roentgen level will only last seven to eight hours after the blast for a 10 megaton size or

24 hours for a 50 megaton bomb. For a 10 megaton blast the radiation will have dropped below 100 again in about 36 hours, but for the largest bombs this will take five days. If you were that close to a 50 megaton blast (25 miles) you would likely be dead from burns, or at least blinded. A 50 megaton blast can cause flash burns and blindness to 50 miles away. Several smaller bombs saturating an area could give the same effect.

You should try to stay in your shelter for two weeks at least but three would be better. If you must come out for any reason, wait as long as you can before going out, bundle up as though going into a blizzard, stay out not one second longer than you have to. Remove the outside clothes and leave them near the door (as far as you can away from you). Don't forget boots and covering your mouth.

Those victims of the initial blast still living may have broken bones, burns, or blindness. Splint broken bones using a stick, leg of a chair, etc., and tape or rags, getting them as straight as possible. Burns should be rinsed if water is available, then treat as any normal burn, giving aspirins or any other available medicines to cut the pain. If a victim has been blinded, especially if there are no serious burns around the eyes, keep the eyes covered for several days, checking occasionally whether sight has returned. Such blindness could be temporary if the person is given time to recuperate.

Victims of radiation will experience varying degrees of nausea, vomiting, diarrhea, cramps, and even coughing up blood. Radiation first attacks the body's immune system, so germs that already exist in your body can make you very

**"CARRY"**

$$\begin{array}{r}
 11 \\
 397 \\
 + \\
 528 \\
 \hline
 925
 \end{array}$$

**REGROUPING IN ADDITION**  
*Requires 16K Extended Basic*      **Cassette \$19.95**

\*TRS-80 Color Computer      **Ohio Residents**  
 \*Trademark of Tandy      **Add 5½% Sales Tax**

**APPEALING GRAPHICS, FUN REWARDS AND SOUND**  
**Used Successfully In Classrooms and In Homes**

**ALSO AVAILABLE-CASSETTES**

Clock	\$24.95	Mathfact	\$16.95
Money	\$19.95	ABC's	\$ 9.95
Subtract/Borrow	\$19.95	Spelling	\$16.95
Question	\$19.95	Hangword	\$14.95

**WRITE FOR FREE DESCRIPTIVE BROCHURE**  
**DEALER INQUIRIES WELCOME**

**B5 SOFTWARE** 

**1024 Bainbridge Pl.      Columbus, OH 43228**  
**(614) 276-2752**

sick. Make the patient as comfortable as circumstances permit.

The first listing which follows is the heart of the fallout prediction program, and will run on any 16K ECB or disk-extended system. If you have a printer the program gives you the option of using that printer for your output device. NOTE: Since this is a high-priority program the printer utilities patch themselves in and overwrite any other routines you may have residing in high memory. The second listing is not an essential part of the program. It is only a high-res drawing of the "cigar-shape" of a fallout pattern as a reminder. For those who do not have the time to punch in the program from this listing, I understand the *Fallout* program will be available through *Rainbow On Tape*.

(Mr. Mickle is one of the owners of Circle City Software and has been interested in the question of nuclear war for some years.)



100	02C0
200	0579
248	0CF8
500	0EED
700	131D
800	17A9
1000	19CE
END	1CB9

Listing 1:

```

10 CLS:GOTO 1750
20 CLEAR250:IF PEEK(65314) AND1
  THEND=0 ELSED=-2:GOTO810
30 CLS3:IFPEEK(65314) AND1 THEND
  9=0:GOSUB1110:POKE65314,13:ELSEI
  NPUT" I SEE A PRINTER ATTACHED,

```

```

DO YOU WANT OUTPUT TO PRINTER"
;A$:IFLEFT$(A$,1)="Y"THEND9=-2:EL
LSED9=0
40 PRINT#D9," THIS PROGRAM IS SI
MPLY AN AID TO HELP YOU KNOW WH
AT TO DO IN CASE OF NUCLEAR ATT
ACK.
50 PRINT#D9:PRINT#D9,"THERE ARE
TWO SECTIONS.
60 PRINT#D9," (1) TABLES WHICH
HELP YOU TO PLOT WHERE THE RADI
ATION WILL FALL.
70 PRINT#D9," (2) EXPLANATIONS
OF HOW TO PROTECT YOURSELF.
78 IFD9=-2THENCLS
80 PRINT#D9:PRINT#D9,"DO YOU WAN
T WIND/FALLOUT TABLES":INPUT"";W
$:PRINT#D9,CHR$(13):IFLEFT$(W$,1
)="N"THEN190
90 PRINT#D9," SINGLE PATTERN":IN
PUT"";Z$:PRINT#D9:IFLEFT$(Z$,1)=
"N"THENZ=0ELSEZ=1
100 PRINT#D9," SIZE BOMB IN MEGA
TONS (1,5,10, OR 50)":INPUT"";
S$:PRINT#D9:S=VAL(S$)
110 IFS=1ORS=5ORS=10ORS=50THEN1
2ELSE100
112 CLS:PRINT@67,"ANY RADIO STAT
IONS STILL ABLE TO BROADCAST WILL
TRANSMIT BOTH VALUABLE SURVIVAL
INFORMATION AND INFO ABOUT HE
AVY RADIATION IN YOUR AREA. IN
CASE YOU CANNOT PICK UP BROADCAST
S FOR YOUR AREA YOU SHOULD MAKE A
GUESS AT WIND
113 PRINT"SPEED AND DIRECTION BA
SED ON THE WEATHER PATTERNS IN YO
UR LOCALE.
115 GOSUB510
120 IFZ=1THENPRINT#D9," WIND SPE
ED (MPH)":INPUT"";W$:PRINT#D9:W=
INT(VAL(W$)):IFW<0ORW>300THEN120
130 CLS:PRINT#D9:PRINT#D9,CHR$(1
2)" WIND/FALLOUT PATTERN":PR
INT#D9," "S"MEGATON BOMB
140 PRINT#D9,STRING$(32,61);
150 IFZ=0THENFORW=10TO50STEP10
160 GOSUB530
170 GOSUB510
180 IFZ=0THENNEXT
190 PRINT#D9,"DO YOU WANT PROTEC
TION METHODS ":INPUT"";Z$:IFLEFT
$(Z$,1)="N"THEN1000
200 CLS:PRINT#D9,"PROTECT AGAINST
RADIOACTIVE DUST";STRING$(32,6
1);
203 PRINT#D9," IF YOU ARE CAUG
HT OUTSIDE AT THE INSTANT OF THE
EXPLOSION: YOU MAY RECEIVE FL
ASH-BURNS AND TEMPORARY OR PERMA

```

# MORETON BAY SOFTWARE

For TRS 80 Color Computer & TDP 100

**PLANETARIUM** - a five program astronomy package. See constellations, stars, moon and planets 16K extended \$16.95.

**CUBE SOLVER** - a highly graphic ML program. Technically interesting: Program will: solve cube on screen, mix it up, print solutions to screen, tape or printer. 16K extended \$19.95

**TOWER CASTLE** - a classic thematic adventure with music and color, tough but honest (Reviewed December 1982 *Rainbow*) 32K extended \$17.95

Moreton Bay



Software

TRS 80® Tandy Corp.

## MORETON BAY SOFTWARE

A DIVISION OF MORETON BAY LABORATORY  
316 Castillo Street  
Santa Barbara, CA 93101  
(805) 962-3127

CA Residents Add 6% Sales Tax





### PRETTY PRINTER

This M/L utility program will allow you to write your code in as compact a form as you wish, but list it to the screen or printer in an easy to read 'PRETTY PRINT' format. Turn this: -

```
10 PRINT "EXAMPLE": FOR X=A TO M: FOR Y=S TO P: Z=X + Y: PRINT Z: NEXT Y: NEXT X
```

```
Into this: - 10 PRINT "EXAMPLE":  
             FOR X = A TO M:  
               FOR Y = S TO P:  
                 Z = X + Y:  
                 PRINT Z:  
               NEXT Y:  
             NEXT X
```

With one simple command.

CAT. NO. DM001 16K Ext \$12.95

### P.U.F.F.

Say the magic word and P.U.F.F. your print formatting problems disappear. The Printer Utility File Formatter turns any word Processor (that produces ASCII text files) into a super printer formatter. Embedded codes will perform the following functions: -

- \* Send control codes to your printer.
- \* Set left and right margins at any time.
- \* Set headers and footers.
- \* Left, Right and Fill Justify.
- \* Centre the next 'n' lines.
- \* Temporary indent (neg or pos).

Plus many other features

CAT. NO. DM002 16K Ext \$24.95

### CONVERT

Have you ever wondered how many cubits there are in a furlong? With this program you can convert units of length, volume, area or weight from or to the equivalent Imperial, Metric, Nautical or Historical systems of measurement.

CAT. NO. DM006 16K Ext \$9.95

### DATAMAIL

The ultimate cassette based mailing list program for home or business use. Fully customized data collection screen allows you to set your own field lengths and field titles. Fast machine language sort by any column in any field. Save all or any block of files for latter reading by DATAMAIL or your own letter program. Merge two or more lists, search by record number or key word in any column. One key commands for Input, Kill, Change. Print single records or any block of files, 1, 2, 3 or 4 across. 32K holds about 300 files.

CAT. NO. DM003 16K Ext \$14.95

### FIRST SAMPLER

Six programs for the price of one. All have been published in popular computer magazines and are now available on one tape at this special price.

- \* MATH Improve your mental math skills
- \* WORD Make words from the supplied letters in this game for the whole family.
- \* CONVOY Can you sink the computers convoy before it sinks yours?
- \* BAGIT Train your memory to remember the things you put in the bag.
- \* VECTORS Row your boat across the river without going over the falls.
- \* AHHA Find the treasure chest in Another Haunted House adventure. Don't get caught by the Old Miser's ghost.

CAT. NO. DM005 16K Ext \$9.95

### COCOCOPY

This all M/L Program will copy BASIC or M/L programs including most Auto Start Programs. It will supply the beginning, ending and offset addresses and allow you to change the load address for M/L programs. I/O errors are ignored so that bad tapes can be corrected. Programs can be renamed and the motor/audio functions are controlled from the keyboard.

CAT. NO. DM004 16K Ext \$12.95

**SEND \$2.00 FOR OUR 25 PAGE CATALOGUE**

**Refunded with first order**

**We are dealers for the following fine companies: -**

- ARK ROYAL GAMES
- COMPUTER ISLAND
- D S L COMPUTER PRODUCTS
- DYNAMIC ELECTRONICS
- FRANK HOGG LABORATORIES
- HOMEBASE COMPUTER SYSTEMS
- HOME RUN COMPUTER PRODUCTS
- LITTLE BITS COMPUTING SERVICES
- MARK DATA PRODUCTS
- NELSON SOFTWARE SYSTEMS
- RAINBOW CONNECTION SOFTWARE
- SPEECH SYSTEMS
- SUGAR SOFTWARE
- THE PROGRAMMERS GUILD
- TOM MIX SOFTWARE
- WEST BAY COMPANY

**BOOKS from  
SYBEX \* BYTE \* OSBORNE**

**THE  
DATAMAN**

Box 431, Sta. B  
Hamilton, Ontario  
Canada L8L 7W2  
1-416-529-1319

**ALL PRICES  
IN CANADIAN  
DOLLARS**

NENT BLINDNESS CLOSE YOUR EYES IMMEDIATELY ! THROW YOURSELF FACE-DOWN TO THE GROUND. PULL YOUR HOOD OR SOME  
 204 PRINT#D9, "CLOTHING OVER YOUR HEAD, FOLD YOUR HANDS UNDER YOU. A CULVERT, DRAIN, EVEN A ";  
 205 PRINT#D9, "SMALL GROUND SWELL COULD PROTECT YOU. THE INFERNO OF THE FIREBALL WILL LAST FROM ONE AND A HALF TO TWO MINUTES.  
 208 GOSUB510  
 209 PRINT#D9, " A SEVERE DOUBLE SHOCKWAVE WILL FOLLOW AT ABOUT 5 SECONDS PER MILE OF DISTANCE FROM BLAST (AT FIFTY MILES THIS EQUATES TO FOUR MINUTES DELAY AFTER FLASH.)  
 210 PRINT#D9, " THE DUST WILL DESCEND FROM ABOVE, AND COLLECT ON THE GROUND TO BE STIRRED UP AS YOU WALK, OR BY PASSING MILITARY OR CIVILIAN VEHICLES.  
 220 PRINT#D9, " YOU SHOULD COVER YOUR MOUTH WITH A HANDKERCHIEF OR ANY CLEAN CLOTH YOU CAN BREASTHE THROUGH. THIS IS EVEN MORE IMPORTANT THAN COVERING UP YOUR BODY,

AS ANY":GOSUB510:PRINT#D9:PRINT#D9, "RADIOACTIVE PARTICLES WHICH GET INSIDE ";  
 230 PRINT#D9, "YOUR BODY CAN LAY THERE  
 240 PRINT#D9, " DOING DAMAGE FOR SEVERAL DAYS, OR EVEN WEEKS. YOU SHOULD ALSO COVER YOUR BODY AS MUCH AS YOU CAN, AND WASH UP ON REENTERING YOUR SHELTER. IF WATER IS AT A PREMIUM, AT LEAST BRUSH OFF...!";  
 243 PRINT#D9, " IF YOU ARE WITHIN THE CROSS-WIND DISTANCE OF THE 10 ROENTGEN PER HOUR ZONE, YOU ARE ALREADY GETTING SOME RADIATION. YOU MUST GET INSIDE AS FAST AS POSSIBLE. EVERY THREE FEET OF AIR OR THREE INCHES OF DIRT BETWEEN YOU AND  
 245 GOSUB510:PRINT#D9, "THE RADIATION CUTS THE LEVEL YOU ARE GETTING IN HALF, SO RUN TO THE CELLAR OR ANY CENTRAL ROOM WITHOUT WINDOWS, COVER UP WITH ANY CLOTHES, BLANKETS, ETC. AND  
 247 PRINT#D9, "WAIT. THE FIRST HOUR OR MORE THE LEVEL OF RADIATION INCREASES TO MAXIMUM, THEN BEGINS TO DROP OFF SLOWLY. EVEN IF YOU HAD NO TIME TO DRAW WATER, YOU CAN STAY HIDDEN FOR AT LEAST A DAY, OR MORE. DO NOT COME OUT IN THE OPEN  
 248 PRINT#D9, " UNTIL YOU ABSOLUTELY HAVE TO!  
 250 GOSUB510:GOTO770  
 260 U=10:RETURN  
 270 V=8:U=8:RETURN  
 280 V=7:U=7:RETURN  
 290 V=6:U=6:RETURN  
 300 U=5:V=5:RETURN  
 310 U=32:RETURN  
 320 U=25:RETURN  
 330 U=22:RETURN  
 340 U=19:RETURN  
 350 U=16:RETURN  
 360 U=37:RETURN  
 370 U=34:RETURN  
 380 U=31:RETURN  
 390 U=28:RETURN  
 400 U=25:RETURN  
 410 U=104:RETURN  
 420 U=97:RETURN  
 430 U=91:RETURN  
 440 U=85:RETURN  
 450 U=80:RETURN  
 460 IFL=100 THEN U=INT(U\*10+V):U=INT(U\*10/21-9):V=U-INT(U/10\*10):U=U/10

**NEW**

## FILE CABINET A SERIOUS UTILITY MULTIPURPOSE INFORMATION MANAGEMENT

Maintain any file you create; inventory, investments, mailing lists, budgets, recipes, etc.

**Alphabetizes**  
**Sorts Numeric Entries**  
**Searches** for key words or numbers  
**Computes** totals & averages by categories  
**Saves Records**, changes or deletes them, up to 20 entries for each record, up to 256 characters for each entry.  
 preformatted mailing list & recipe program included  
**Output to Screen, Printer or Tape.**  
**PRINT** all or selected records.

**+, -, X, ÷** Numeric Entries.  
 Owners Manual included with sample files  
 16K, 32K, Memory Expandable.  
 Extended Basic Required



Moreton Bay **\$29.95** postage paid  
 CA Residents Add 6% Sales Tax

**MORETON BAY  
 SOFTWARE**  
 A DIVISION OF MORETON BAY LABORATORY  
 316 Castillo Street  
 Santa Barbara, CA 93101  
 (805) 962-3127



Software



# FLEXPLUS DOS.....\$69.95

**A Powerful, easy-to-use disk operating system!**

**\*FREE\* COLOR COSMIC INVADERS—FREE on every FLEX+ DISK \$21.95 Value.**

**FLEXPLUS** is a powerful, easy-to-use disk operating system. Spectral Associates has adapted TSC's FLEX to the best DOS completely compatible with Radio Shack software for use on the Color Computer. Eliminate the need for Radio Shack's TRS DOS — use **FLEXPLUS** with Editor/Assembler and have the options of a full range of utilities. **FLEXPLUS** works on the 32K Radio Shack disk system with 64K memory chips with a High Resolution multi-screen format that supports a 24 line by 51 character display! Also included are special enhancements to Radio Shack's Disk system when you are running FLEX with single or double sided, single or double density, 35, 40 and 80 track drives.

## Advantages of FLEXPLUS DOS

- Best price anywhere
- Wealth of existing software
- Easy start-up — just type "RUN FLEX +"
- Print Spooling — print while editing, assembling, etc.
- Allows you to save RS compatible binary disk files from **FLEXPLUS**
- NO HARDWARE MODIFICATIONS NEEDED
- Warranty will not be voided — no need to open computer
- All FLEX compatible software will run including INTERRUPT DRIVEN SOFTWARE
- Requires Supercharger board
- \$149.95 for **FLEXPLUS**, Editor/Assembler and Supercharger

## SUPERCHARGER

Allows machine language access to all 64K RAM in a Series E PC board. No hardware mods.

**\$39.95**

## KEYS OF THE WIZARD

Best new adventure game! Over 200 rooms filled with creatures, tricks, treasures and magic spells. Cassette save feature built-in.

**\$19.95**

## MAGIC BOX

Special utility design to load MOD I/III Level II 500 baud BASIC programs into color computer.

**SUPER PRICE \$24.95**

For orders only, call toll-free

# 1-800-426-1830

Except WA, AK, HI

Business Office and Information

Call **206-565-8483**

Office open 8:30-4:30 P.S.T.

We accept VISA, MASTERCARD, AMERICAN EXPRESS.

Add 3% for shipping. NO C.O.D.  
All prices U.S. FUNDS.

**FLEXPLUS.....\$69.95**

for new F Boards

**FLEXPLUS with Supercharger.....\$89.95**

for use with E Boards

**FLEXPLUS with Supercharger and Editor/Assembler.....\$149.95**

## ULTRA 80CC (Editor/Assembler)

Features:

- TRS CC DOS compatible
- Library Files
- Macros
- Conditional Assembly

Most powerful disk-based editor/assembler for the Color Computer available (requiring 32K) and a "must" for anyone considering the development of machine language programs. Complete with 68-page documentation.

FANTASTIC PRICE

**\$49.95**

## ORACLE (Graphic Monitor)

Tired of writing machine language programs with no way to debug them easily? Your problems are solved, the ORACLE is here.

**ONLY \$29.95**

## GREAT BASIC GAMES

ALCATRAZ II  
C-TREK  
GAME PACS  
GAMBLIN GAMES  
PIRATES AHOY  
DESERT GOLF  
YAHTCC

ESCAPE FROM PRISON CITY  
SUB HUNT  
LASER COMMAND  
SPACE TRADERS  
BATTLE FLEET  
LOTHAR'S LABYRINTH  
MAZE ESCAPE

ARCADE GAMES • ADVENTURE GAMES  
BASIC GAMES • UTILITIES • BOOKS  
HARDWARE • MODEMS

Call or write for a complete catalog.

## Quality Hardware

### and Software Support

**TRS-80 COLOR COMPUTER**  
**TDP SYSTEM 100**  
**DRAGON 32**



# SPECTRAL ASSOCIATES

143 Harvard Avenue

Tacoma, WA 98466



## PETROCCI FREELANCE ASSOCIATES

651 N. Houghton Rd.  
Tucson, AZ. 85748  
602-296-1041

### Stagecoach

Enter the Wild West Days as you try to carry gold across the desert in a stagecoach. Hot in pursuit are the James Gang and of course, Indians!! To make matters worse you are responsible for the safe journey of Annabelle, the judge's daughter. Hi-Res graphic screen plots your progress. Lots of fun surprises await you in this game -shootouts, kidnappings and more. Don't miss the fun!

16 K Extended ..... \$19.95

### Inspector CLUEseau



Sherlock Holmes/Agatha Christie fans-It's finally here—A murder mystery game for the 80-C! Mr. Goodbody has been killed in his mansion and you must solve the mystery. WHO committed the murder, WHERE did it occur and HOW was it done! Question suspects, find the secret passage, and break the code to get clues. Hi-Res graphics enhances this excellent game. The computer records the clues you obtain on a clue inventory screen and also provides suspect descriptions at the touch of a finger. A fast, fun game that will sharpen your deductive skills. Every game is different!

32K Extended ..... \$19.95

### Stress Evaluator



Assess your present level of stress and how it affects your potential for illness. Evaluate the amount of life change you can effectively handle in the future. The Stress Evaluator is a valuable tool for recognizing, measuring and managing stress. The program also provides a Coping Ability Test which shows your ability to handle stress in general. Provides goal setting exercises and meditation graphic screens to help achieve stress-alleviating goals. All results output to printer.

16K Extended ..... \$24.95

### Weather Watch



If you **really** care about the weather, this program is for you. Three programs provide you with National Weather Service approved statistics in a monthly report format. Input of daily high and low temp. and rainfall outputs a report of monthly average temps. and range; high and low averages; high and low temp. for month; total rainfall; days rain > .1 in.; heating and cooling degree days; days high > 90; days low < 32; days low temp. < 32 and > 0; days low < 0; day of highest range. Also retrieves a single day from data file for review. All data outputs to printer. Well documented.

16K Extended ..... \$24.95

### Forecaster & Weather Watch (Disk)

Forecast general weather conditions with 80% accuracy with this fun, simple to use program. Although not meant to replace National Weather Service forecasts, this program is informative and enjoyable to use. You can even create your own weather by setting the variables!! Provides general forecast including precipitation probabilities. Includes Weather Watch program also all on one easy to use disk.

32K Extended Disk ..... \$49.95

Include \$1.50 for handling for each program.

Az. Residents add 6% Sales Tax.

Quantity Discounts to Dealers.

CIS subscribers contact through EMAIL 70435,754

**PROGRAM DEVELOPMENT: Computer Software  
Documentation / Graphics / Consultation**

```

470 IFL=1000THENU=INT(U*10+V):U=
INT(U/11):V=U-INT(U/10*10):U=U/1
0
480 IFL=3000THENU=INT(U*10+V):U=
INT(U/21+1):V=U-INT(U/10*10):U=U
/10
490 IFS>5 ANDL=3000THENU=INT(U*1
0+V):U=INT(U/2):V=U-INT(U/10*10)
:U=U/10
500 RETURN
510 IFD9=0 THENPRINT@480," PRE
SS ANY KEY TO CONTINUE:":ELSEPR
INT#D9,"PRESS ANY KEY TO CONTINU
E:"
520 IFINKEY$="" THEN520ELSECLS:RE
TURN
530 PRINT#D9:PRINT#D9," "W" M.P.
H. WIND
550 PRINT#D9,"LEVEL*UPWIND*CROSS
*DOWN*MAXWIDTH":PRINT#D9," R/HR
MI. MI. MI. MI.
560 L=10:GOSUB570:L=100:GOSUB570
:L=1000:GOSUB570:L=3000:GOSUB570
:RETURN
565 IFW<5THENW=5
570 B=0:D=INT(936*INT((W+5)/10))
:IFS=10THEND1=10:B=10:M=2420:ELS
EIFS=1THEND1=44:M=515:ELSEIFS=5T
HEND1=15:B=5:M=1512:ELSEIFS=50TH
END1=3:B=15:M=8066
580 D=D*10:D=INT(D/D1)
590 IFL=100THEND=INT(D/2.7):ELSE
IFL=1000THEND=INT(D/7.3):ELSEIFL
=3000THEND=INT(D/13)
600 IFW<5 ANDL=1GOSUB570
610 M=M/W:IFL=100THENM=M/1.9:ELS
EIFL=1000THENM=M/4.7:ELSEIFL=300
0THENM=M/11
615 IFB+INT(W/10)<1THENB=1
620 V=0:B=B+INT(W/10):ONB GOSUB2
60,270,280,290,300,310,320,330,3
40,350,360,370,380,390,400,410,4
20,430,440,450
630 GOSUB460:IFL=10THENC1=110:C2
=350:C3=400:C4=1250:ELSEIFL=100T
HENC1=47:C2=150:C3=180:C4=550:EL
SEIFL=1000THENC1=14:C2=46:C3=60:
C4=175:ELSEIFL=3000THENC1=4:C2=1
5:C3=16:C4=50
640 IFS<<1THEN660
650 C=-110*(L=10)-47*(L=100)-14*
(L=1000)-4*(L=3000)
660 IFS<<10THEN680
670 C=-400*(L=10)-180*(L=100)-60
*(L=1000)-16*(L=3000)
680 IFS<<5THEN700
690 C=-350*(L=10)-150*(L=100)-46
*(L=1000)-15*(L=3000)
700 IFS<<50THEN720
710 C=-1250*(L=10)-550*(L=100)-1

```



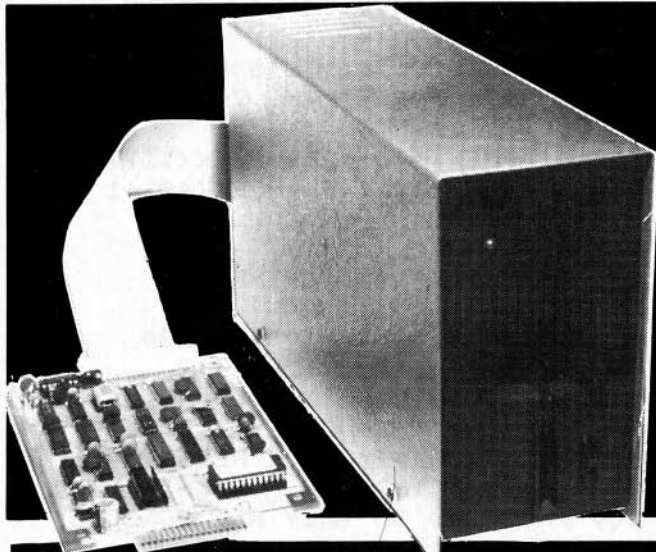

# "THE ALTERNATIVE" COLOR COMPUTER DISK SYSTEMS

**NOW ONLY 449<sup>95</sup>** 40 TRACK DRIVE **200 K BYTES**  
USER STORAGE

**NOW ONLY 549<sup>95</sup>** 80 TRACK DRIVE **400 K BYTES**  
USER STORAGE

ROM SOFTWARE

A Full Featured  
Basic Compatible DOS

INCLUDES: TG-99 Disk Controller w/CCMD 9 DOS  
ROM • 40 Or 80 Track Disk Drive • Power Supply •  
Case • 2 Drive Cable • 9 Disk Utility Programs  
• CCEDT9 Disk Text Editor • Disk Text Processor I

Manufactured Under License From Tall Grass Technologies

## Editor / Assembler CO-RES9

CO-RES9 is a Co-resident Editor/Assembler that will allow you to create, edit and assemble machine language programs for the color computer. It will quickly and efficiently convert assembly language programs into machine code files. It will output machine object code to either cassette tape in a 'CLOADM' compatible format or directly to memory for direct execution.

CO-RES9 editor / assembler tape  
w / manual ..... ~~\$39.95~~ **\$29.95**

R.S. DISK EDITOR & ASSEMBLER Disk  
w / manual ..... ~~\$79.95~~ **\$49.95**

## Text Pro II

"The Professional's Word Processor"

### TEXT PROCESSOR FEATURES

- Character Fill
- Programmable Footer
- Right Justify Line
- Multiple Footnotes
- Three Indent Modes
- Three Programmable Headers
- Ten Programmable Tab Stops
- Margin Justification Left & Right
- Decimal Align, Center, Left & Right Justify on Tab Column
- Display & Input from Keyboard
- Change Formatting During Processing

### TEXT EDITOR FEATURES

- Single Keystroke Edit Command
- Append Files From Tape or Disk
- Fully Integrated Disk File Handler
- Edit or Process Files Larger Than Memory
- (No Conversion Required) Fully ASC II Compatible
- Full Featured Line Oriented Screen Editor
- Search and Replace Any Character Pattern
- Copy, Move or Delete Lines or Blocks of Text
- Edit Basic, Text or Assembler Files

**TEXT PRO II Features Over 70 Commands In All. Disk ... \$79.95**

## DATA PACK TERMINAL PACKAGE

- Full Text Buffering
- Terminal Baud Rates 300 To 9600 Baud
- Automatic Word Wrap Eliminates Split Words
- Full / Half Duplex
- Automatic File Capture
- Programmable Word Length, Parity & Stop Bits
- Automatic Buffer Size At Memory Limit
- Save & Load Text Buffer To Tape Or Disk
- Send Files Directly From Buffer Or Disk
- Full Disk Support For Disk Version
- Printer Baud Rates 110-4800
- Send Control Codes From Keyboard
- ASCII Compatible File Format



- Display On Screen Or Output Contents Of Buffer To Printer

We also have a disk version available called "DISKPACK." It includes all the commands mentioned plus commands for disk control. They include: Disk Load, Disk Save, Directory, Send Disk File and Kill Disk File. As usual all files are Basic Compatible ASCII formatted files which are also compatible with our Text Editor and Word Processor programs.

Datapak on tape w / manual ..... **\$24.95**  
Diskpack for R.S. disk w / manual ..... **\$49.95**  
Diskpack for CCMD 9 w / manual ..... **\$39.95**

5566 Ricochet Avenue  
Las Vegas, Nevada 89110

**CER  
COMP**

**(702) 452-0632**

All Orders Shipped  
From Stock  
Add \$2.50  
Postage

```

75*(L=1000)-50*(L=3000)
720 C=C/10
730 IFM=0THENM=1
740 IFW<5THENU=C:V=E
745 IFU>C THENC1=U:U=C:C=C1
750 PRINT#D9,USING"####";L;:PRI
NT#D9,USING"###.#";U;:PRINT#D9,
USING"###.#";C;:PRINT#D9,USING"
####";D;:IFM>=10THENPRINT#D9,U
SING"####";M:ELSEPRINT#D9,USIN
G"###.#";M
760 RETURN
770 PRINT#D9,"IF YOU HAVE PRIOR
WARNING THAT A NUCLEAR EXPLOSION
IS IMMINENT, DRAW WATER",,"
IF YOU HAVE A CELLAR, GO OUT AN
D SHOVEL DIRT, GRAVEL, ETC. AR
OUND THE FOUNDATION AND BACK- FI
LL OVER WINDOWS. DRAG BOARDS, MA
TTRESSES, OR ANYTHING TO
780 PRINT#D9,"FLOOR OVER YOUR SH
ELTER AREA, TOCUT DOWN RADIATION
.", " IF YOU ARE GOING TO WAIT I
N A CLOSET, PICK ONE NEAR THE CE
NTER OF THE HOUSE, PULL MATTRESSE
S OROTHER HEAVY FURNITURE AROUND
IT.":GOSUB510:PRINT#D9,"LAYING
IN A BATHTUB WITH A TABLE
785 PRINT#D9,"OR HEAVY MATTRESS
OVER IT MIGHT PROTECT YOU IF THE
HOUSE SHOULD COLLAPSE DURING TH
E SHOCK-WAVE."
787 PRINT#D9,"BUT IS NOT SUFFICI
ENT AGAINST THE RADIATION (FAL
LOUT). AFTER THE SHOCK-WAVE, IF
YOUR HOUSE ISDESTROYED, RUN TO
A NEIGHBOR'S, OR ANY PUBLIC FALL
OUT SHELTER IFLESS THAN A MINUTE
OR TWO AWAY.. BUT GET AS FAR
FROM THE DUST
788 PRINT#D9,"FALLING OUT OF THE
SKY AS YOU CAN.",," GOOD
LUCK !":GOSUB510
790 GOTO1000
800 END
810 CLS:PRINT"

```

```

820 PRINT:PRINT" CALCULATING PR
OGRAM LOCATION
830 'POKE150,174:' THIS POKE SETS
BAUD RATE FOR SILENT 700 PRINTE
R
840 X1=PEEK(116)*256+PEEK(117)+1
850 X2=PEEK(39)*256+PEEK(40)+1
860 X3=X1-X2
865 RESTORE
870 READA$:IFA$><"^"THEN870
880 READA$
890 IFLEFT$(A$,1)="^"THEN880
900 IFA$="END"THEN920
910 X=X+1:GOTO880
920 IF X3=0 THEN 950
930 PRINT:PRINT"I SEE RESERVED M
EMORY...BUT THIS IS A high prior
ity PROGRAM, SO THEY ARE GONE NO
W, SORRY...!"
940 PRINT:FORM=1TO15:PLAY"L25504
CDEFGAB05BAGFEDC":NEXT
950 X2=X1-X: CLEAR 200,X2
960 POKE&H167,57
970 RESTORE:X=PEEK(39)*256+PEEK(
40)+1
980 PRINT" ONE MOMENT, PLEASE
...!
990 GOTO1560
1000 RUN
1110 RETURN
1540 '
1550 '
1560 READA$
1570 IF LEFT$(A$,1)<>"^" THEN159
0
1580 MR(Y)=X:Y=Y+1:GOTO1560
1590 IFA$="END"THEN1610
1600 POKEX,VAL(A$):X=X+1:GOTO156
0
1610 DATA ^,52,22,214,111,193,25
4,38,2,141,5,53,22,126,130,115
1620 DATA 129,13,38,27,124,3,249
,246,3,249,241,3,252,37,12,246,3
,251
1630 DATA 189,162,133,90,38,250,
127,3,249,127,3,250,57
1640 DATA 129,12,38,20,125,3,249
,39,14,134,13,189,162,133,141,21
3,125,3,249,38,246,134,12,57
1650 DATA 124,3,250,246,3,250,24
1,3,253,37,36,129,48,37,7,192,10
,241,3,253,37,25,134,13,141,22,1
41,177,246,3,255,247,3,250,39,8,
134,32,189,162,133,90,38,250,18,
18,57,57,126,162,133,END
1660 POKE&H168,INT(MR(0)/256):PO
KE(&H169),MR(0) AND 255
1690 POKE&H3FB,8:POKE&H3FC,25:PO
KE&H3F9,0:POKE&H3FA,0

```

**TAX 82**  
by Warren S. Napier

- A user-friendly program for Form 1040, Schedules A & B
- Improved, fully updated
- Extended or non-Extended BASIC
- PRINTs hard copy
- 16K AVAILABLE IMMEDIATELY - \$10.95
- 32K soon: Tape \$11.95, disk \$14.95



MARS SOFTWARE — RD 1, Box 475  
Mars, PA 16046

Software That's Out of This World!



# Color Computer Power!

## DATAFILE

\$24.95

A unique, multipurpose data storage system. DATAFILE is a sophisticated, non-formatted database with user-defined categories. It performs string searches, deletes, sorts, merges and prints in various formats. With a disk drive, you can work with files larger than RAM. Ideal for mailing lists, cataloguing, file systems, etc. Help files are included along with complete documentation.

## DATAFILE 64k

\$29.95

All the features of the above with much more memory space. Ideal for small business applications. Documentation available for \$5. and is refundable with your order.

Draw electronic circuits with our...

## Electronics Drafting Board

You can design wiring diagrams easily with our Electronics Drafting Board. Create complex electronic plans, label components, erase, etc. and then have a finished schematic from your printer. Screen print routine and disk I/O included. Comes with sample schematic file and excellent documentation. Electronics Drafting Board is fun to use and will save you hours of work.

\*6 viewing windows on a 480x540 pixel work sheet\*Joystick or arrow-key control\*Text labels components on screen\*All electronic symbols\*Complete documentation with on-screen help\*Prints finished schematic to any Epson MX (with Graftrax) or Radio Shack printer\*Disk save/load.

Requirements: 64K Color Computer with Extended Basic, disk drive and (optional) printer. \$39.95 includes operating manual, program on disk, postage & handling.

## PAINTPOT

\$24.95



Bring out the artist in you and your family! With PAINTPOT you can create fast, effortless sketches and drawings. PAINTPOT gives you joystick or keyboard control on 4 screens. (3 screens on 16K) There are 4 cans of paint to play with! A touch of a key starts animation effects flashing from screen to screen.

Your works of art can be saved or loaded from cassette or disk and, with our Screen Print Program (see below) you can have a hard copy on your printer. PAINTPOT comes with complete documentation and a help screen is available. Great fun for kids and creative adults!

\$24.95 on cassette. \$29.95 on disk. Both 16 & 32K on the same tape/disk. Extended Basic required.

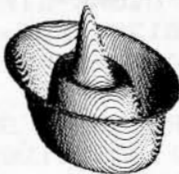

## SCREEN PRINT

For use with Epson MX-80/100 printers. Three print formats, all versions of Basic, PMODESO, 2,3&4. Normal or negative image. Many useful features! Complete documentation.

TTD \$14.95 DTT \$14.95

Transfer your programs to disk or tape effortlessly. Allows you to individually select or mass copy programs.

## DISKPRO

No more crashed disks! This program can be a lifesaver. DISKPRO creates back-ups of your disk directory and allocation tables. A valuable tool to protect your software. Comes on disk with complete documentation.

## WILLIAM TELL OVERTURE \$14.95

You really won't believe the incredible music coming from your Color Computer! "It is without a doubt the best example of computer music I've ever heard." (Color Computer News magazine) Now you can enjoy these high quality machine language programs at an affordable price. Specify Beethoven or William Tell when ordering. Two versions, 16 & 32K available on the same tape or disk.

## BEETHOVEN'S FIFTH \$14.95

## BLACKBOX

Transmit your programs, machine language, basic or files over the phone. And you don't need a modem! Switch on BLACKBOX and when you load or save a program, you automatically have a copy at a friend's house. Two BLACKBOX's are needed, one for each end of the connection.

## SPIDER ATTACK

Shoot-em up action! Try to stop our invading spiders with your joy-stick controlled laser gun. Watch out you don't get eaten!

## MILLBORN

Like to play cards? From France we bring you this popular card game for COCO. Lots of fun!

## COLORSHOW

Music. Color and your COCO! Just load in COLORSHOW, connect the small recorder plug to your stereo (or simply put a musical tape in your computer's tape recorder) and watch the fun. Having a party? Turn off the room lights and turn up the music

## STARS

Educational and entertaining. STARS creates a dome of the night sky on your TV. Constellations, stars and other naked eye objects are drawn using Extended Resolution graphics. Horizon views show planet positions after sunset. Detailed documentation.

Add \$1.50 postage on each software. Programs available on disk for \$5. extra. We pay high royalties to software authors. For more information on this or any of our products, write!



**ilume** design

Dept. R, 4653 Jeanne Mance St.,  
Montreal, Quebec, Canada H2V 4J5

# Genesis Software

presents

## Color Computer Programs

### ★ Bigfoot

Hunt Bigfoot in a hidden maze of caverns and twisting tunnels that are displayed in hi-res graphics as you move. Seek out the lair of Bigfoot while avoiding perils along the way. Features multiple levels and many options of play. Each hunt takes place in a new, randomly generated maze. Challenging and fun. Requires 32K extended basic. Tape cassette (postage paid).....\$21.95

### ★ The Enchanted Forest

The BIG adventure in hi-res graphics is here! Move through more than 50 scenes on a quest to rescue the captive princess. Decisions are made according to visual clues, not text. There are many inhabitants in the Enchanted Forest — some are friendly, some are not. This is a sophisticated computer adventure — a real challenge. Requires 32K extended basic.

Tape cassette (postage paid).....\$21.95

(The Enchanted Forest was reviewed in the Dec. 1982 issue of Rainbow).

### ★ The Game Show

Now a lively party game where two teams compete against the clock to name several items in a category. Includes 60 rounds with color graphics and sound. Machine language routine for fast response. Requires 16K extended basic and joysticks.

Tape cassette (postage paid).....\$19.95

(The Game Show was reviewed in the Jan. 1983 issue of Rainbow).

★ ★ ★ ★ ★ ★ ★ ★ ★ ★ ★ ★ ★ ★ ★ ★

## Special Offer!!!

Through March 31, 1983, with each Genesis Software order, you'll also receive a three-day admission ticket to the 1983 RAINBOWFEST in Chicago on April 22-24. The event is the first national trade show and exhibition for the TRS-80 Color Computer.

★ ★ ★ ★ ★ ★ ★ ★ ★ ★ ★ ★ ★ ★ ★ ★

**Genesis Software**  
**P.O. Box 936**  
**Manchester, Mo. 63011**



Personal checks welcome - no delay.  
Missouri residents add 5.625 percent sales tax.

```
1700 POKE&H3FF,0
1710 POKE&H3FD,32
1720 POKE&H167,&H7E
1730 DATA 141,3,126,142,144
1731 '^
1740 D=2:CLS:GOTO30
1750 PMODE0:PCLEAR2:GOTO 20
```



✓	1100	0216
	1300	03A9
	1400	0662
	END	093E

Listing 2:

```
1000 PCLS: CLEAR100:GOSUB1110:GOT
O 1800
1010 CIRCLE(159,91),100,3,.4,.75
,.25
1020 CIRCLE(255,91),254,3,.17,.3
2,.695
1030 LINE(17,91)-(24,91),PSET:LI
NE(20,88)-(20,94),PSET
1040 PRESET(1,91):PRESET(1,90):P
RESET(1,89):PRESET(1,92)
1050 PSET(2,90,3):PSET(2,89,3):P
SET(2,91,3):PSET(2,92,3)
1060 LINE(120,88)-(180,88),PSET:
LINE(180,88)-(165,73),PSET:LINE(
180,88)-(165,103),PSET
1070 DRAWHM$:DRAW"S4":BB$="THE F
ALLOUT PATTERN WILL"+CHR$(10):GO
SUB1200
1080 BB$="OCCUR AS A CIGAR-LIKE
SHAPE"+CHR$(10):GOSUB1200:BB$="D
OWN-WIND FROM THE BLAST"+CHR$(10
):GOSUB1200
1090 BB$=CHR$(10)+CHR$(10)+" BLA
ST"+CHR$(10)+CHR$(10):GOSUB1200:
DRAW"S8":BB$=" WIND"+CHR$(10)
:GOSUB1200
1100 FORL=1TO2000:NEXT:RUN
1110 DIMAZ$(60)
1120 FORLE=0TO60
1130 READAZ$(LE):NEXTLE
1140 NC$="BR3BU7"
1150 NL$="BD4"
1160 BS$="BL9"
1170 HM$="BM0,10"
1180 CC=1
1190 RETURN
1200 CC=1:FORTT=1TOLEN(BB$)
1210 A9$=MID$(BB$,TT,1)
1220 IFA9$=CHR$(94)THENDRAWHM$:G
OTO1320
1230 IFA9$=" THENDRAW"BR9":GOTO
1320
1240 IFA9$=CHR$(8) THENDRAWBS$:G
OTO1320
1250 IFA9$=CHR$(10)THENDRAW"BD12
BL250":GOTO1320
```



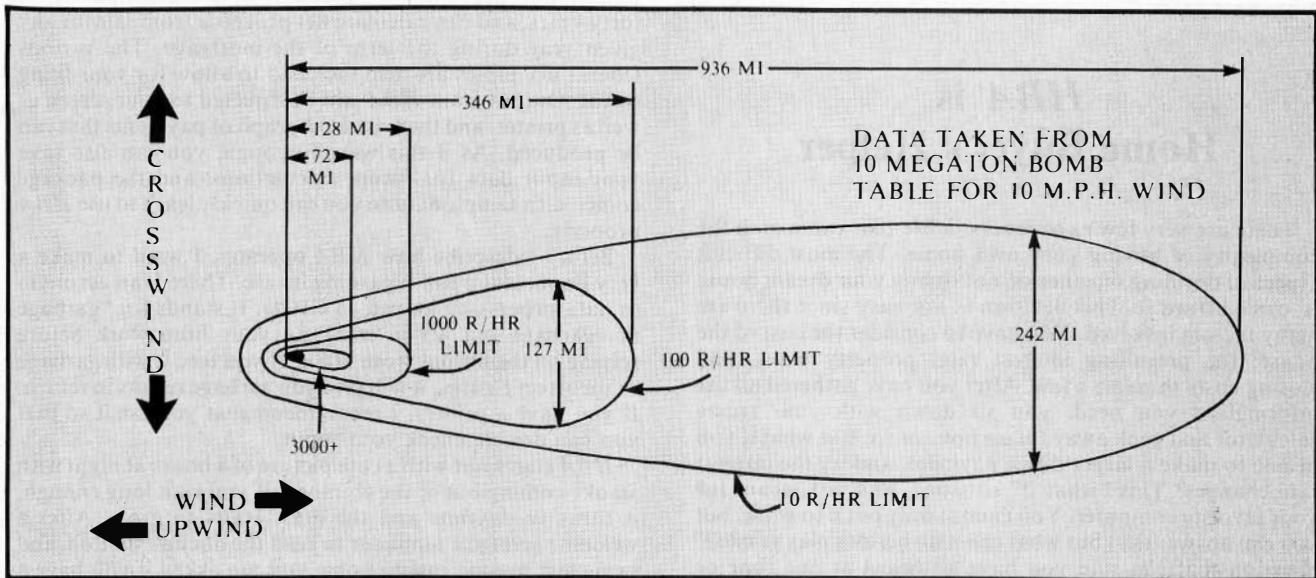

```

1260 IFA9%=CHR$(12) THENPCLS:GOT
01320
1270 IF" ">A9% OR"Z"<A9% THEN132
0
1280 CC=CC+1
1290 IFCC>27 THENDRAWNL$:FORI=1T
027:DRAWBS$:NEXTI:CC=1:GOTO1310
1300 DRAWNC$
1310 DRAWAZ$(ASC(A9%)-30)
1315 DRAW"BR1
1320 NEXT
1330 RETURN
1340 GOTO1340
1350 DATA' !"#%&'()*+,-./
1360 DATA BD7BR5,NR1D4R1NU4BD2ND
1L1D1R1,ND1R1D1NL1D1G1BR3E1U2L1D
1R1BD6,BD1R1NU1ND4R3NU1NR1D3NL4N
R1D1BD2,BD1BR2NU1NR2L1G1F1R2F1G1
L1NL2D1BR2BD1,R1D1L1NU1BR5G5BR5L
1D1R1NU1,BR1BD1ND1E1R1F1D1G1L1NH
1G1D2F1R1E1U2NH1NE1F1BD2,ND1R1D1
NL1D1G1BD4BR1,BR1G1D5F1
1370 DATA F1D5G1BR1,BR3D3NL3ND3N
E2NF2NG2NH2R3BD4,BD3R3NU3ND3R3BD
4,BD4ND1R1D1NL1D1G1BR1,BD4R4BD3,
BD7U1R1D1NL1,BR5BD1G5BR5BD1
1380 '0-B
1390 DATABD1BR1D5F1R1E1U5H1L1G1B
D6BR5,BD1E1D7L1R2BR1,BD1E1R3F1D2
G1L3G1D2R5,BD1E1R3F1D1G1NL2F1D2G
1L3H1BF1BR4,BD4NR5E4D7BR1,NR5D3R
4F1D2G1L3H1BF1BR4,BD1BR5H1L3G1D5
F1R3E1U2H1L3G1BF3BR2,ND1R5D1G5D1
BR5,BD1E1R3F1D1G1NL3F1D2G1L3H1U2
E1H1NU1BF5
1400 '9:;<=>?@
1410 DATA BD6F1R3E1U5H1L3G1D2F1R
3E1BD4,BD1R1D1L1U1BD3R1D1L1U1BD3
BR2,BD1R1D1L1U1BD3NR1D1R1NU1D1G1

```

```

BR2,BD1BR3G3F3,BD3NR4BD2R4BD2,BD
1F3G3BR3,BD1E1R2F1D1G2BD2ND1L1D1
R1BR3,BD2BR1ND2E1R1F1D2G1L1H1BR3
D1R1U4H1L3G1D5F1R4
1420 ' A-H
1430 DATA BD7U3NR5U3E1R3F1D6,ND7
R4F1D1G1NL4F1D2G1NL4BR1,BD1D5F1R
3E1U1BU3U1H1L3G1BD6BR5,D7R4E1U5H
1L4BD7BR5,NR5D3NR4D4R5,NR5D3NR4D
4BR5,BD1D5F1R3E1U2NL2BU2U1H1L3G1
BD6BR5,D7U4R5NU3D4
1440 ' I-T
1450 DATA R4L2D7L2R4BR1,BD5D1F1R
3E1U6BD7,D7U4R3E2NU1G2F2D2,D7R5,
ND7F3E3D7BR1,ND7F5NU5D2,BD1D5F1R
3E1U5H1L3G1BD6BR5,ND7R4F1D2G1L4B
D3BR5,BD1D5F1R3E1U5H1L3G1D4BR3F2
,ND7R4F1D1G1NL4F1D3,BD1D1F1R3F1D
2G1L3H1BU5E1R3F1BD6,R4L2D7BR2
1460 ' U-Z
1470 DATA D6F1R3E1U6BD7,D4F3E3NU
4BD3BR1,D7E3F3U7BD7BR1,D1F5D1BL5
U1E5U1BD7,D2F2ND3E2U2BD7BR1,R5D1
G5D1R5
1800 PMODE3:SCREEN4:GOTO1010

```

\$14.95 ML Character Set for LPVII - Real Descenders  
 -Transparent to user - Specify 16K or 32K  
 -ex: Varying Styles Available  
 \$9.95 MLDISK - Prints M. L. prog.start, stop, transfer  
 address from disk, Extended Basic req'd  
 \$14.95 Instrument Flight Simulator -high perf jet,  
 easy to use, NOT A GAME. Extended Basic req'd  
 Also, for PC-1 computer \$9.95  
 WE HAVE COLORPEDE by Intracolor!  
 KRT Software (813)-321-2840  
 P.O. Box 41395 . St. Petersburg, FL 33743 .

## HBA is Home Buyer's Helper

There are very few experiences in life that can match the complexity of buying your own home. The most difficult aspect of deciding whether or not to buy your dream house is, can I afford it. This decision is not easy since there are many factors involved. You have to consider the cost of the house, the prevailing interest rate, property taxes, and closing costs to name a few. After you have gathered all the information you need, you sit down with your trusty calculator and peck away for an hour or so. But what if you decide to make a larger down payment, and/or the interest rate changes? This "what if" situation was just meant for your favorite computer. You cannot only put it to work, but you can answer the "but what can it do besides play games?" question that I'm sure you have all heard at one time or another. If you are still with me, this is where the purpose of this review comes in.

The *Home Buyer's Analyzer*, which I shall refer to as *HBA* from now on, is a set of programs that will enable you to easily figure out exactly what it will cost you to buy a home. But this is only the beginning. Its many features include calculations of monthly payment, effective monthly payment after tax considerations, effects of appreciation in the value of the home, federal tax benefits, year of sale

figures, and many more. *HBA* can handle a loan of up to forty years, and can calculate net proceeds from sale for any given year during the term of the mortgage. The various federal tax tables are also included to allow for your filing status. Output from *HBA* can be directed to your screen as well as printer, and there is also a graph of payments that can be produced. As if this wasn't enough, you can also save your input data for future calculations, and the package comes with sample data so you can quickly learn to use *HBA* properly.

Before I describe how *HBA* operates, I want to make a very important point regarding its use. There is an acronym in data processing known as GIGO. It stands for "garbage in—garbage out." You must do your homework before relying on the output from *HBA*. If you feed it with garbage or incorrect figures, it will give you garbage results in return. If you have a printer, I recommend that you use it so that you can double check your input.

*HBA* starts out with a cute picture of a house at night with smoke coming out of the chimney. If you wait long enough, it turns to daytime and the grass starts to grow. After a welcome screen, a reminder to read the documentation, and some last minute instructions, you are asked if you have a printer. At this point *HBA* gets down to business. You are then asked about your federal income tax filing status, intended year of purchase, and your state and/or local tax bite. You are then presented with a review screen with the opportunity to make changes in case you goofed up. *HBA* is now getting ready to ask you a whole slew of questions. It is here that your previously saved figures can be recalled if you want. Some of the things you are asked at this point are purchase price, down payment, interest rate, term of mortgage, and annual income. As before you are given a review screen before proceeding. By the way *HBA* also handles balloon (variable rate) mortgages.

So far *HBA* has been a one-way street. Nothing but questions, questions, questions. How about some output? Here is where *HBA* really shines, but first some more questions. What kind of output do you want? You can get a particular year displayed, all years plus year of sale, or year of sale only. Some of the output figures are monthly payment (with and without property taxes included), mortgage balance, interest paid, and your federal income tax with and without your tax benefits from interest and property tax deductions. After reviewing your output you are asked (what, more questions!) if you would like a graph produced showing your total payment, effective (after tax) payment, and effective payment after property appreciation. This was the only feature of *HBA* I thought could use some improvement. The three lines plotted on the graph were usually too close together due to the scale chosen. As far as I'm concerned this is a very minor problem, and in fact the graph feature is really just a frill and in no way affects the real value of *HBA*. Last but not least, your final two questions. Do you want to save your input figures and do you want another go at it.

Computers are very good at number crunching and *HBA* will push your CoCo to its limits. The documentation included is complete and will hold your hand all the way through. Most importantly, there are definitions given for all of the input and output fields. No assumption is made that you understand all the buzz words involved in such a complex scenario. If you are in the market for a home, consider *HBA* before you buy.

(Home Buyer's Analyzer, Silver Spring Software, 18 Silver Spring Road, West Orange, NJ 07052, \$39.95 disk, \$34.95 tape)

—Gerry Schechter

### DOUBLE DUTY

You've spent a lot of money on your computer. Let it do double duty and protect your residence when you are away.

DOUBLE DUTY connects quickly to CoCo's ports and allows timed on/off control of one or more devices such as bells, sirens, lights, dialers, even sprinkler systems. Any number or combination of dry contact magnetics switches, foil, electric eyes, motion detector or may be connected. Series or parallel, norm, open or closed contacts. 10 foot cord allows remote location to avoid wire clutter.

Software may be user modified or write your own short simple programs in BASIC. DOUBLE DUTY will work with any COLOR COMPUTER, even 4K!

Full documentation included with tips for designing an effective alarm system layout.

DOUBLE DUTY plus tape, \$39.95 postage included

### BLACKJACK ROYALE



More than just a game, but a system to help you win at the casinos. High resolution graphics deal realistic cards (10 of diamonds has 10 diamonds) and pre-set rules duplicate 80% of the world's casinos or enter you own to match where you play.

Full realistic play includes double down, splits, surrender, insurance bet, 1-8 decks used, burnt cards, shuffle frequency and more. A complete card counter option allows entry of any commercial blackjack winning system for evaluation. Each card can be given any count value and the computer keeps track of how many of what cards have been dealt and the total remaining deck point value. Teaches the game and will train you to count cards and win.

Play your cards right and this software will make you money at the casinos, the author did!

Requires 32K EB, no joysticks req'd.

Cassette and very complete documentation and Blackjack tutorial. \$34.95 postage included

# JMN

CA RESID. ADD 6 1/2% SALES TAX

BOX 32215, SAN JOSE, CA 95152

CIS 71525,367



# GIVE YOUR CHILD AN UNFAIR ADVANTAGE



Don't just depend on others to provide the basic education your child needs to succeed in tomorrow's world. While test scores of others may go down, your child's scores can improve dramatically when you provide him or her with individualized **MICRO SCHOOL PROGRAMS**, in Reading, Math, English Usage, Spelling, and Games that Teach. Learning at home can be fun.

He or she can master basic skills, using a **MICRO SCHOOL PROGRAM**, in just minutes each day if you have an **APPLE, ATARI, TRS-80, TRS-80 COLOR** or **TDP** personal computer at home.

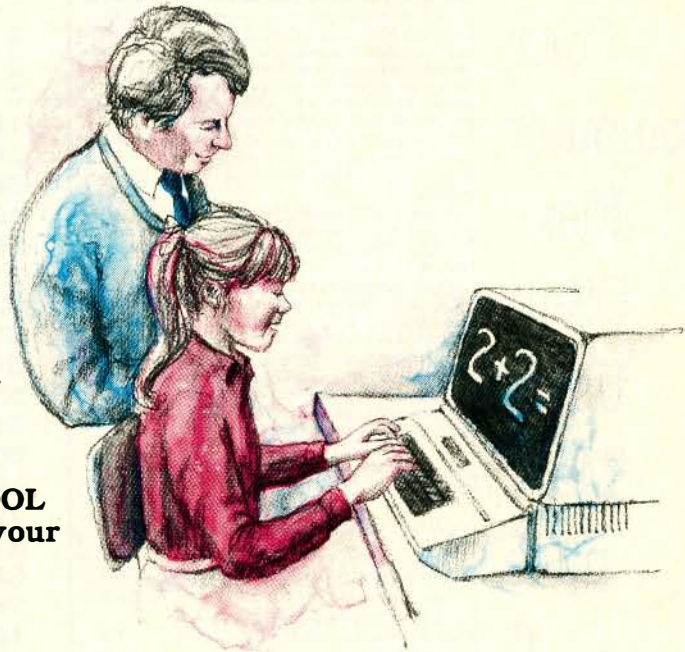

**ASK FOR MICRO SCHOOL PROGRAMS BY NAME** at your local computer store.

**BERTAMAX INC.**  
101 Nickerson #202  
Seattle, WA 98109  
(206) 282-6249  
© 1982. Bertamax, Inc.



**PERSONALIZED INSTRUCTION ON PERSONAL COMPUTERS**



## DOS 'Detach' Saves Wear and Tear

By Herbert Schroeder

The attached listing should be of interest to Color Computer owners with disk drives. The program allows you to "detach" the disk operating system (i.e. return control to non-disk Extended BASIC) without having to physically unplug the disk controller. The advantage of this is that now you can run machine language programs that won't work on the Radio Shack disk system without the hassle of unplugging the disk ROM Pack. This saves wear and tear on the connectors, reducing the chances of I/O errors due to bad connections.

The program can be loaded from tape or disk. After running, it will tell you to press reset. When you do this, the computer does a cold start from Extended BASIC, ignoring the function exactly as if the disk drive were unplugged, even though the controller is in fact still in the ROM port. You can even use the high-speed poke. I can't guarantee that this procedure is fool-proof, but so far it has enabled me to run every "non-disk" program (machine language and BASIC) that I own without unplugging the drive.

To reattach the disk operating system, type *POKE* 113,0 and press Reset. This does a cold start to disk Basic.

The program works by copying the RAM initialization routines out of BASIC and Extended BASIC and into high RAM. It alters the routines to omit the check for the presence of the disk controller. (Note: the disk controller does not use pins 7 and 8 to auto start the way other ROM packs do.) The Reset vector is changed to point to the altered initialization code. The part of the initialization routine that checks for memory size must also be altered, or else it interferes with the code in RAM. This is done in lines 51 to 53, by directly inserting the memory size for your machine. As printed here it is for a 32K computer. For 16K change the "&H7F" in line 52 to "&H3F." For a 16K machine, you will also need to change the location in RAM where the code is copied. (I put mine starting at &H7000.)

I hope this procedure will save other disk owners as much annoyance and frustration as it has me.

### The listing:

```

1 REM      PROGRAM "DSKDET"
2 REM      (DISK-DETACH)
3 REM
10 CLEAR 200,&H6FFF
20 POKE &H7000,&H12
30 FOR N=1 TO 16
40 POKE &H7000+N,PEEK (&HA073+N)
50 NEXT N
51 POKE &H7000+17,&H8E
52 POKE &H7000+18,&H7F
53 POKE &H7000+19,&HFE
54 FOR N=20 TO 78
55 POKE &H7000+N,PEEK (&HA073+N+1
2)
56 NEXT N
60 FOR N=1 TO 167
70 POKE &H7000+78+N,PEEK (&HB001+
N)
80 NEXT N
90 POKE &H7000+246,&H7E
100 POKE &H7000+247,&H80
110 POKE &H7000+248,&HB0
120 POKE &H72,&H70
130 POKE &H73,&H00
140 PRINT "PRESS RESET TO DETACH
DISK"
    
```

Color  
Computer  
Flex\*  
OS-9†  
Users  
Move  
up to  
C  
Language

DO YOU WANT faster running programs (over 100 times faster than BASIC)? A high level language that is also a low level language? A compiler that runs in less than 32K? Assembly language output? Position independent code? Extensive library functions in source assembly code? Periodic newsletters with new library functions? An aid in learning assembly language? Liberal version updates?

C IS DESTINED to become the language of the eighties: A compact, highly versatile, easy to use language, excellent to use to build games, applications, utilities, operating systems, etc.

DUGGER'S GROWING SYSTEMS with over 21 years of experience in computing was first on the market with a 6809 C compiler. The compiler has been extensively tested, revised, and proven.

DUGGER'S GROWING SYSTEMS C is a growing subset of the standard C. Version 1 contains all the necessary C commands (while, if, if else, int, char, etc.). Version 2 contains additional features (float, long, for, goto, etc.).

AN EXTENSIVE LIBRARY in assembly language source is provided (char, I/O, formatted print, file handling, string manipulating, etc.) TRS DOS version also has additional functions which use the BASIC ROM functions (CLS, POLCAT, floating point, draw, etc.).

#### ORDER NOW (new low prices)

TRS DOS C Version 1.2 (disk version)	\$49.95
Computerware disk assembler	49.95
Computerware Scribe (Editor-text formatter)	49.95
Order all three and save \$10	139.95
C Programming Language by Kernighan & Ritchie (a must)	17.95
OS-9 C Version 1.2	95.00
Flex O9* C Version 2.3	120.00
C.O.D. & Foreign handling add 15%	
MasterCard and Visa accepted.	

**DUGGER'S GROWING SYSTEMS**

Post Office Box 305  
Solana Beach, California 92075  
(619) 755-4373

\*OS-9 is a trademark of Microware, Inc.  
†FLEX is a trademark of Technical Systems Consultants, Inc.





# ONLY THE BEST SOFTWARE ON TAPE AT THE BEST PRICE

(under 75 cents a program...)

Radio Shack  
Color Computer  
TDP  
System 100



Get 12 tapes a year containing over 75 colorful programs — and give your typing fingers a vacation.

A subscription to **CHROMASETTE Magazine** consists of 6 to 8 ready-to-load programs on tape delivered by First Class Mail every month. Programs like Blockade, Drawer, Mansion Adventure, CK Monitor, Append, Germ, and Cataloger.

Give yourself an extended holiday — Get a subscription to **CHROMASETTE Magazine**. Or just take a break and try a back issue (your fingers may never work again) . . .

### The Bottom Line:

1 year (12 issues)	\$45.00	Calif. residents add 6% to single copies.
6 months (6 issues)	\$25.00	North America — First Class postage included
Single Copies	\$ 5.00	Overseas — add \$10 to subscriptions and \$1 to single copies. Sent AO rate.

### The Fine Print:

All issues from July 1981 available — ask for list.

Programs are for the **Extended BASIC** models and occasionally for disks.

**Chromasette** MAGAZINE

P.O. Box 1087 Santa Barbara, CA 93102 (805) 963-1066  
MasterCard/Visa





# Power (of Attorney) At Your Fingertips



By Glenn B. Knight

I am happiest when I can send a check to some young computer wizard and get a program that will do something I want my computer to do for me. Eventually the world will awaken and recognize what we color computer pioneers have been telling them (that we are an insatiable market), and we will have all of the software that we need. That day is not yet today—so every now and then we have to write a program to meet our particular needs.

This little gem was zapped out (if you can call two weeks' work zapping out) when I was forced to fork over thirty-five hard-earned bucks to a lawyer for a Power of Attorney. I am by no means a programmer, and the results show it—but the bottom line is that it does the job.

Our son was going to visit relatives for two weeks, and we wanted to give them permission to have a doctor glue him back together, if he were to fall off his dirt bike.

This POA looked almost exactly like the one we got last year for our daughter to visit my sister, and an awful lot like the one we had for a friend to sell our car during one of our frequent moves. They could have been mass produced by a computer. (This is when the light bulb appeared over my head.)

On closer examination I saw the POA as a series of sub-routines with variable strings of information inserted. The only difference between a POA to sell a car or one to authorize medical care was a single paragraph.

Since I had just picked up a Line Printer VII on sale and was anxious to see what it could do for me, I decided to have it print a Power of Attorney.

As things turned out, I got carried away and wrote instructions that offer five different Powers of Attorney:

- 1 - to sell an auto
- 2 - to register an auto
- 3 - to get medical care for a child
- 4 - to rent a house to someone
- 5 - to sell a house

In addition to that, it will print the Notary statement at the bottom, if you want it, and it will even include the name of the Notary, if you have it. Then it will give you the option to print a duplicate copy, again, only if you want it. This

program is so user friendly that it even thanks you for allowing it to serve you.

One word of caution—these are simple Powers of Attorney; if your situation is complicated, or you are doing this as part of your business, consult a lawyer. Unless you have a simple situation, and the POA fits your needs EXACTLY, get professional help. But for 90 per cent of the times you will need a personal POA, this program will do just fine.

You will still have to get your POA notarized. Hmmmm. I wonder how you go about having a Color Computer commissioned a Notary?



240 0441  
675 0E31  
END 1E9E

The listing:

```

5 CLS
10 CLEAR 500
15 'SPECIAL POWER OF ATTORNEY
20 'BY GLENN B KNIGHT, 1982
25 PRINT "THIS PROGRAM WILL CREA
TE A"
30 PRINT "SPECIAL POWER OF ATTOR
NEY FOR"
35 PRINT "ONE OF FIVE PURPOSES."
40 PRINT
45 PRINT "IT HAS BEEN PREPARED W
ITH THE"
50 PRINT "AID OF AN ATTORNEY AND
SHOULD"
55 PRINT "BE SUITABLE--WHEN NOTA
RIZED--"
60 "FOR GENERAL APPLICATION"
65 PRINT
    
```



```

70 PRINT "IF THIS DOCUMENT DOES
NOT"
75 PRINT "APPEAR DIRECTLY APPLIC
ABLE TO"
80 PRINT "YOUR PARTICULAR SITUAT
ION,"
85 PRINT "CONSULT AN ATTORNEY."
90 PRINT
95 INPUT "PRESS [ENTER] WHEN REA
DY";E$
100 CLS
105 PRINT
110 PRINT "TURN ON PRINTER AND"
115 "ALIGN PAPER"
120 PRINT
125 INPUT "PRESS [ENTER] WHEN RE
ADY";F$
130 PRINT "STAND BY"
135 PRINT#-2, CHR$(31)
140 PRINT#-2, "SPECIAL POWER OF
ATTORNEY"
145 PRINT#-2, CHR$(30)
150 PRINT#-2, STRING$(80,42)
155 INPUT "NAME OF PERSON(S) GRA
NTING POA";N$
160 PRINT "STREET ADDRESS"
165 INPUT A$
170 INPUT "CITY";T$
175 INPUT "COUNTY";C$
180 INPUT "STATE";S$

```

```

185 PRINT "NAME OF APPOINTEE(S)"
190 INPUT AN$
195 PRINT "STREET ADDRESS"
200 INPUT AA$
205 INPUT "CITY";AT$
210 INPUT "COUNTY";AC$
215 INPUT "STATE";AS$
220 PRINT "DATE POA TO EXPIRE"
225 PRINT "(DAY MONTH YEAR)"
230 INPUT D$
235 CLS
240 PRINT "SELECT TYPE OF POWER
OF ATTORNEY"
245 PRINT "A=SELL AUTO"
250 PRINT "B=REGISTER AUTO"
255 PRINT "C=MEDICAL CARE FOR CH
ILD"
260 PRINT "D=LEASE REAL ESTATE"
265 INPUT "E=SELL REAL ESTATE";P
$
270 IF P$="A" GOTO 800
275 IF P$="B" GOTO 900
280 IF P$="C" GOTO 1100
285 IF P$="D" GOTO 1200
290 IF P$="E" GOTO 1300
295 TO 240
300 CLS:PRINT "PRINTING, PLEASE
STAND BY"
305 PRINT#-2, "KNOW ALL MEN BY T
HESE PRESENTS, that I, ";N$;"//"

```



STRICTLY  
COLOR  
SOFTWARE

P.O. Box 382  
West Point, PA 19486

## MISSION:EMPIRE!

NOW FOR 16K  
Does NOT require Extended BASIC

Some of the cute is gone, but none of the excitement and playability which made "The RAINBOW" say about the 32K version that

*"We recommend MISSION:EMPIRE!"*



### MISSION:EMPIRE!

for disk or cassette \$19.95

A strategic wargame/strategy game. Starting with one planet, incomplete intelligence and limited resources, you must conquer the rest of your galaxy. The game takes 2-5 hours and is DIFFERENT EVERY TIME! All versions offer the option of saving a game in progress.

Specify 32K disk, 32K cassette or 16K version - the 32K versions require Extended BASIC, the 16K version does not. The disk version is normally shipped on a cassette with instructions for transferring to disk. If you want the program shipped on a disk add \$3.00.

Send check, money order or Mastercard/Visa number (including expiration date and SIGN order). Price includes shipping. PA residents include 6% sales tax.

\*All programs require Color Computer™ (Tandy Corp.) or TDP System 100 Computer™ (RCA Corp.).

```

310 PRINT#-2, "a legal resident
of ";A$;", ";T$;"//";
315 PRINT#-2, "County of ";C$;"
State of ";S$;"//";
320 PRINT#-2, "desiring to execu
te a SPECIAL POWER OF ATTORNEY h
ave made, constituted and"
325 PRINT#-2, "appointed, and by
these presents do make, constit
ute and appoint"
330 PRINT#-2, AN$;" whose addres
s is ";AA$;", ";AT$";
335 PRINT#-2, "County of ";AC$;"
State of ";AS$";
340 PRINT#-2, "my Attorney-in-Fa
ct to act as follows, GIVING AND
GRANTING unto my said"
345 PRINT#-2, "attorney full pow
er to:"
350 RETURN
355 PRINT "(DO NOT USE COMMAS)"
360 RETURN
400 PRINT#-2, "FURTHER, I do aut
horize my aforesaid Attorney-in-
Fact to perform all"
405 PRINT#-2, "necessary acts in
the execution of the aforesaid
authorization with the"
410 PRINT#-2, "same validity as

```

```

I could effect if personally pre
sent."
415 PRINT#-2, "Any act or thing
lawfully done hereunder by my sa
id attorney shall be binding"
420 PRINT#-2, "on myself and my
heirs, legal and personal repres
entatives, and assigns"
425 PRINT#-2, "PROVIDED, however
, that all business transacted h
ereunder for me or for my"
430 PRINT#-2, "account shall be
transacted in my name, and that
all indorsements and"
435 PRINT#-2, "instruments execu
ted by my said attorney for the
purpose of carrying out the"
440 PRINT#-2, "foregoing powers
shall contain my name, followed
by that of my said"
445 PRINT#-2, "attorney and the
designation 'Attorney-in-Fact'."
450 PRINT#-2, "FURTHER, unless s
ooner revoked or terminated by m
e, this Special Power of"
455 PRINT#-2, "Attorney shall be
come NULL and VOID from and afte
r ";D$;"."
460 PRINT#-2, "IN WITNESS WHERED
F, I have hereunto set my hand a
nd seal this      day of"
465 PRINT#-2, "                                19
      "
470 PRINT#-2, ""
475 PRINT#-2, "WITNESSPUTS:
-----
----- (SEAL) "
480 PRINT#-2, ""
485 PRINT#-2, "-----
      ";A$
490 PRINT#-2, ""
495 PRINT#-2, "-----
      ";T$;", ";
S$
500 PRINT#-2, ""
505 PRINT#-2, "-----
      "
600 CLS
605 PRINT "DO YOU WISH TO HAVE T
HE NOTARY?"
610 PRINT "STATEMENT ATTACHED?"
615 INPUT "Y OR N";O$
620 IF O$="N" GOTO 2000
625 PRINT#-2, ""
630 PRINT#-2, STRING$(80,42)
635 PRINT "NAME OF NOTARY"
640 INPUT NN$
645 "STATE OF COMMISSION"
650 INPUT NS$

```

**1982 Interactive "What If"**

## TAX Analysis

PROGRAM - 1040 - SCHED. A  
for the TRS-80 Color Computer™ (16K)

### OPTIMIZE TAX RETURNS

Makes It Easy & Simple To:

- MODIFY Tax Data & Receive IMMEDIATE RECALCULATION of Return.
- SAVE/Restore Tax Data
- Menu Driven Tree Structured S/W



---

**ONLY \$19.99**

Add \$1.00 postage  
Plus \$1.50 if C.O.D.  
In VA, add 4% sales tax



7602 SEOANE COURT  
FALLS CHURCH, VA 22042



```

655 PRINT "COUNTY"
660 INPUT NC$
665 PRINT "DATE COMMISSION EXPIRES"
670 PRINT "(DAY MONTH YEAR)"
675 INPUT NE$
33448 CLS:PRINT "PRINTING, PLEASE STAND BY"
685 PRINT#-2, "State of ";NS$
690 PRINT#-2, "County of ";NC$
695 PRINT#-2, "I, ";NN$;TAB(35);
"a Notary Public in and for the"
700 PRINT#-2, "County and State aforesaid, do hereby certify that on the
day of"
705 PRINT#-2, " ", 19
, before me personally appeared";N$
710 PRINT#-2, "who is known by me to be the identical person who is described in, whose name"
715 PRINT#-2, "is subscribed to, and who signed and executed the foregoing instrument, and"
720 PRINT#-2, "having first made known to him the contents thereof, he personally acknowledged"
725 PRINT#-2, "to me that he signed and sealed the same on the date it bears as his true, free"

```

```

730 PRINT#-2, "and voluntary act and deed for the uses, purposes and considerations therein"
735 PRINT#-2, "set forth."
740 PRINT#-2, "In Witness Whereof, I have hereunto set my hand and official seal this"
745 PRINT#-2, "day and year above."
750 PRINT#-2, ""
627 PRINT#-2, ""
760 PRINT#-2, ""
765 PRINT#-2, "
-----"
770 PRINT#-2, " " "NN$;", Notary Public"
775 PRINT#-2, "My Commission Expires: ";NE$
780 GOTO 2000
800 CLS
805 PRINT "POA TO SELL AN AUTO"
810 GOSUB 355
815 PRINT "MINIMUM PRICE YOU WILL ACCEPT"
820 INPUT "$";S
825 GOSUB 1000
830 GOSUB 300
835 PRINT#-2, "Sell, in my name,

```

# ALL YOU'VE WANTED IN A COMPUTER! AND MORE...

## TDP SYSTEM 100

A COMPLETE SYSTEM READY TO PLUG INTO YOUR COLOR T.V. SET

### Features:

- 16K Memory
- Expandable to 32K at any TDP Service Center Nationwide; and to 32/64K through Southco, the Georgia Distributor
- Designer Cosmetics in White and Black High Impact Case
- Raised Keyboard with Gold Contacts to Withstand Constant Use
- Standard Basic Built-in (Microsoft)
- RS232 Interface Device Built-in (Permits hook up with printer or telephone modem without purchase of the RS232, a \$200.00 extra charge on most computers.)
- RF Inter ace for Direct Hook Up to any TV Built-in
- Vast Source of High Resolution Arcade Color Games
- Inexpensive Telewriter Word Processing Applications Available
- Programming Manual (s) Included at No Charge
- Bust Out Game Pak Included at No Charge
- Joy Sticks Included at No Charge

MODEL 10-1000



suggested retail  
**ONLY \$379**

**SOUTHCO**  
SALES CORPORATION

Dealer Enquiries for Complete Information Call or Write:  
Tommy Thompson or Roy Green (404) 355-2960  
1500 Marietta Blvd. N.W. Atlanta, Georgia 30318

## MASTER DIRECTORY

Put order in your life! Have your diskettes multiplied and now are out of control? MASTER DIRECTORY will sort out your problems and locate all of your programs. Only takes seconds to add all of the files on one diskette to the master directory.

- ‡ Master listing by diskette number with description.
- ‡ Master listing of all your programs in either diskette sequence or program sequence.
- ‡ Basic for easy customizing: fast mach lang sort
- ‡ Requires 32k with printer
- ‡ Only \$20

Other COCOPRO products: (All machine language)

FULL SCREEN EDITOR ----- \$15  
Adds arrow-key control for editing of basic programs.

REVERSI ----- \$9  
"Othello"

EXPANDED DIRECTORY ----- \$15  
Saves 120 files on one diskette.

COLOR DIRECTORY ----- \$12  
Fantastic DIR!

COCOSLOTS ----- \$9  
Las Vegas at home.

CASSETTE DIRECTORY  
List program name, length of basic program or start, end and transfer addresses for mach lang program. FREE with all orders if requested or send \$2.50 for program on cassette.

>> FREE CATALOG <<  
Send SASE

Send check or money-order to:

COCOPRO  
P.O. BOX 37022  
ST LOUIS, MO 63141



Postage paid on all pre-paid orders in continental U.S.  
MO residents include 5.625% sales tax.

```
for a price not less than $";S
840 PRINT#-2, "a vehicle describ
ed as: ";SA$;" ";SB$;", ";SC$";
";SD$
```

```
845 PRINT#-2, "VIN ";SE$;" ENGIN
E # "SF$
```

```
850 PRINT#-2, "and to transfer t
itle thereto. I further authori
ze my Attorney-in-Fact"
```

```
855 PRINT#-2, "to do and perform
any and all acts necessary in c
onnection with renewal"
```

```
860 PRINT#-2, "or cancellation,
in my name, of the registration
and/or insurance of"
```

```
865 PRINT#-2, "said automobile."
870 GOTO 400
```

```
900 CLS
```

```
905 PRINT "POA TO REGISTER AUTO"
```

```
910 GOSUB 355
```

```
915 GOSUB 1000
```

```
920 PRINT "STATE TO BE REGISTERE
D IN"
```

```
925 RG$
```

```
930 GOSUB 300
```

```
935 PRINT#-2, "Register, in my n
ame, the following described aut
omobile: "
```

```
940 PRINT#-2, SA$;" ";SB$;", ";S
C$";, ";SD$
```

```
945 PRINT#-2, "VIN ";SE$;" ENGIN
E # ";SF$
```

```
950 PRINT#-2, "in the state of "
;RG$;"."
```

```
955 GOTO 400
```

```
1000 PRINT "DESCRIBE VEHICLE"
```

```
1005 INPUT "MODEL YEAR";SA$
```

```
1010 INPUT "MANUFACTURER";SB$
```

```
1015 INPUT "TYPE";SC$
```

```
1020 INPUT "COLOR";SD$
```

```
1025 INPUT "VEHICLE ID NO";SE$
```

```
1030 INPUT "ENGINE NO";SF$
```

```
1035 RETURN
```

```
1100 CLS
```

```
1105 PRINT "POA FOR CHILD'S MEDI
CAL CARE"
```

```
1110 GOSUB 355
```

```
1115 PRINT "NAME(S) OF CHILD(REN
)"
```

```
1120 INPUT MA$
```

```
1125 GOSUB 300
```

```
1130 PRINT#-2, "Authorize and ex
ecute consent for any and all me
dical care and"
```

```
1135 PRINT#-2, "treatment, inclu
ding major surgery, deemed neces
sary by a duly licensed"
```

```
1140 PRINT#-2, "physician select
ed by my Attorney-in-Fact for th
e health and well being of my"
```



# Meet the Computerware® Clan!



(we're a fun group to know)

**Computerware® can offer you:**

## One-Stop Shopping



In addition to Computerware software, we carry the major manufacturers' products such as printers, modems, memory and software from such companies as Mark Data, Tom Mix, Micro Works, Botek, Frank Hogg Laboratories, TDP, C. Itoh, Aardvark and Dugger Growing Systems.

## Software for OS9!

- OS9 Random BASIC
- OS9 Macro Assembler
- OS9 Editor
- OS9 Text Processor

Also available on FLEX and RS DOS

## Products for the Color Computer



- from home management software
- to programming tools



- to fun and challenging video games

## An Attractive Authorship Program

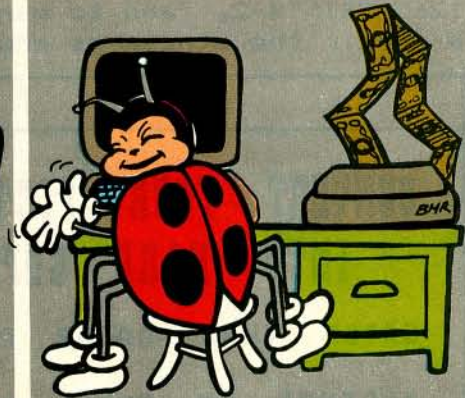

for independent programmers who would like to turn software into cash!

## Dealer Inquiries Invited

Call or write to:



Computerware®  
P.O. Box 668  
Encinitas, CA 92024  
**(619) 436-3512**





```

1145 PRINT#-2, "following named
child(ren): ";MA$;". "
1150 GOTO 400
1200 CLS
1205 PRINT "POA FOR LEASE OF REAL ESTATE"
1210 GOSUB 355
1215 PRINT "ADDRESS OF PROPERTY"
1220 INPUT LA$
1225 PRINT "MINIMUM ACCEPTABLE RENT PER MO."
1230 INPUT "$";L
1235 GOSUB 300
1240 PRINT#-2, "Enter upon and take possession of the following described property, together"
1245 PRINT#-2, "with all improvements thereon: ";LA$
1250 PRINT#-2, "to lease the same upon terms acceptable to my Attorney-in-Fact (but in no event shall such rental be less than $";L;" per month);"
1260 PRINT#-2, "to collect, receive and deposit to my credit the rents or income therefrom;"
1265 PRINT#-2, "and to manage and repair the structures and improvements thereon."

```

```

1270 GOTO 400
1300 CLS
1305 PRINT "POA TO SELL REAL ESTATE"
1310 GOSUB 355
1315 PRINT "MINIMUM ACCEPTABLE PRICE"
1320 INPUT "$";P
1325 PRINT "ADDRESS OF REAL ESTATE"
1330 INPUT PA$
1335 PRINT "LEGAL DESCRIPTION OF REAL ESTATE"
1340 INPUT PB$
1345 GOSUB 300
1350 PRINT#-2, "Sell and convey in fee the following described property,"
1355 PRINT#-2, "together with all improvements thereon, for such amounts as he"
1360 PRINT#-2, "in his judgment deems advisable, but not less than $";P;":"
1365 PRINT#-2, PA$
1370 PRINT#-2, PB$
1375 GOTO 400
1400 CLS:PRINT "ALIGN PAPER"
1405 INPUT "PRESS [ENTER] WHEN READY";O$
1410 PRINT#-2, CHR$(31)
1415 PRINT#-2, "SPECIAL POWER OF ATTORNEY"
1420 PRINT#-2, CHR$(30)
1425 PRINT#-2, STRING$(80,42)
1500 IF P$="A" GOTO 830
1505 IF P$="B" GOTO 930
1510 IF P$="C" GOTO 1125
1515 IF P$="D" GOTO 1235
1520 IF P$="E" GOTO 1345
2000 CLS
2005 PRINT "YOUR SPECIAL POWER OF ATTORNEY"
2010 PRINT "HAS BEENSOUNDPRINTED . YOU MUST"
2015 PRINT "HAVE IT NOTARIZED TO BE LEGAL."
2020 PRINT
2025 PRINT#-2, STRING$(80,42)
2030 PRINT "DO YOU WANT ANOTHER COPY?"
2035 INPUT "(Y OR N)";W$
2040 IF W$="Y" GO TO 1400
2045 CLS
2050 PRINT@197, "IT HAS BEEN A PLEASURE"
2055 PRINT@265, "SERVING YOU"
2060 END

```

## CONVERT YOUR PICTURES INTO HARD COPY

CATCH THAT COLOR PMODE3

PICTURE ON PAPER (USING

A CGP-115 COLOR PLOTTER)

- Machine language subroutines for speed
- Auto start from cassette
- Works with Micro Painter
- Will print pictures from cassette
- Includes sample picture - American Flag

Just \$14.95 plus \$1.50 postage and handling

To: All-American Ultralight Industries/ (AUI)  
1144 Kingston Ln.  
Ventura, Calif. 93001



## Double Density Software

### COLOR TERM + PLUS +

An Intelligent Terminal Program For The Color Computer or TDP 100.

#### Features:

BAUD RATE — 110 to 19200  
Half or Full Duplex  
One or two Stop Bits  
Odd, Even or No Parity  
Word WRAP  
Turn off Lowercase Letters  
Send All Control Characters  
Print Buffer  
Examine Buffer  
Send & Receive BASIC or Machine Language Programs or Files.  
Editor allows entry of text into Buffer as well as Editing of Buffer.  
(Disk Version Has more powerful Editor)

#### Special Feature:

Code & Decode ANYTHING in the Buffer for Secure Transmission or Storage Using a User defined key word  
PRICE \$29.95 (Tape) \$39.95 (Disk) 16k or 32k Req.

#### TAPENAME

Tapename searches tape and stores the name of any program or file. You can print the information to the screen, printer or tape. Also checks for load errors. 4k, 16k, or 32k Req. or Ext. BASIC.  
PRICE \$7.95 (tape)\* D

#### COLOR DISK SAVER

Saves a disk to tape. Reloads disk from saved tape. Also has tape verify command! 32k Ext. BASIC Req.  
PRICE \$12.95 (tape)\* D

#### CURSOR II

Hate that blinking cursor? Tired of seeing the computer print "OK" after your program just bombed? **Cursor II** changes the cursor to a solid, non-flashing red. Enter any message up to 200 characters in length. Your message will be displayed instead of "OK". 4k, 16k, or 32k Req. or Ext. BASIC.  
PRICE \$4.95 (tape)\*

#### SUPER PEEKER

This is a BASIC program that will allow the user to explore the inside of the color computer. Explore the possibilities with **Super Peeker**. 16k or 32k Ext. BASIC Req.  
PRICE \$9.95 (tape)\*

#### —NEW PROGRAMS—

**COLOR BIORHYTHM** Are you up or down today, tomorrow, or years from now? Find out with **COLOR BIORHYTHM**. Uses high res graphics. Send the chart to printer. 16k or 32k Ext. BASIC Req.  
PRICE \$14.95 (tape) D

**DD CLOCK** Don't forget what time it is when you are programming. The time is displayed in the upper right corner of your screen. Shows hours, minutes and seconds. Beeps every hour. 4k, 16k, or 32k. (Ext. BASIC not required.)  
PRICE \$9.95 (tape)\* D

**AUTO LOAD** Auto Load will put any program or file from tape to disk! All machine language programs that load below the top of your disk system are modified so that they will operate properly with a disk system! 16k or 32k Ext. BASIC Req.  
PRICE \$12.95 (tape)\*

#### \*Software Authors Note\*

We are looking for quality software. If you have a program you think is a winner, send it to us. If it meets our standards, you will be paid TOP royalties.



## Double Density Software

### BBS

Look For our Color BBS coming next month—watch this ad for the number—free programs, tips, questions answered—specials—order Programs—all this and more next month.

#### Use your MODEM for something other than a dust catcher—play games!

Two tapes and two sets of instructions are included with each MODEM game.

**MODEM CHESS** Use your Modem and your Color Computer to play chess *over the phone!* Has high res color graphics board and pieces. Make your move, select a message to send, press a button—seconds later your opponent's board is updated automatically. Has audio alerts, let's you know when a move is being made. 16k or 32k Ext. BASIC Req.  
PRICE \$39.95 (tape)\* D

**MODEM CHECKERS** Play checkers *over the phone!* Program allows up to 4 jumps to be made at a time, crown pieces, etc. 16k or 32k Ext. BASIC Req.  
PRICE \$39.95 (tape)\* D

**MODEM IAGO** Play our version of Othello *over the phone!* Make your move, press a key, your opponent's board is updated seconds later! Has a takeback key if you decide you don't like the move you made. 16k or 32k Ext. BASIC Req.  
PRICE \$39.95 (tape)\* D

#### FUN!

#### CLONE ATTACK

Blast those nasties as they appear! 3 skill levels and 9 levels of difficulty. Uses high res color graphics. Joysticks required. 16k or 32k Ext. BASIC only.  
PRICE \$15.95 (tape) (Disk 32k only)

#### FAST!

#### MOON BASE INVASION

Nuclear bombs are nearing your cities! Can you stop them before they reach you? High res graphics. 16k or 32k Ext. BASIC Req.  
PRICE \$12.95 (tape) D

#### COLOR IAGO

Based on popular Othello game. Match wits with your computer! Uses high res color graphics. 5 levels of difficulty. Joysticks required. 16k or 32k Ext. BASIC.  
PRICE \$15.95 (tape) D

#### SUPER!

#### COLORPEDE

Best centipede type game available for the color computer. Uses highest resolution graphics mode with color! This game is as close to the arcade as you can get! We've seen the rest—this one's the best! 16k or 32k Req.  
PRICE \$29.95 (tape only)\*

- \* All machine code D Disk Compatible
- \*\* BASIC with machine code subroutines

Specify Disk when ordering and add \$5.00 per program. Save money and ask that all ordered programs be loaded on one disk. You pay only for the one disk! Please add \$2.00 shipping and handling on all orders. No extra charge on COD orders, Mastercard and VISA accepted. Charge orders add 3%. Texas residents add 5% sales tax. Allow two weeks for personal checks. Your order will usually be shipped within two or three days. We will notify you of any problems within one week. Send 20 cent stamp for free catalog.

Send orders to:

DOUBLE DENSITY SOFTWARE



920 Baldwin Street  
Denton, Texas 76201  
Phone 817/566-2004.





# Let CoCo Keep Track Of Your Utility Bills

By Dennis H. Weide



With the rising cost of utility bills, it gets harder and harder to budget the family income. Here's a program that will help you keep track of your utility cost and usage.

All you do is enter the information from your utility bills and the program arranges it, computes totals, and prints it to the screen or printer as you request. It makes it easier to spot errors in billing as well as allow you to see the average monthly cost of your utilities.

While this program is written for the Albuquerque, NM, area, it can be applied to your area, too, with little or no modification.

It is not necessary to fill in all the data requested. Just fill in the information that is listed on your bill. The program uses REMark statements to show where specific sections are. Using these REMarks, you can find and change any headings necessary. It shouldn't be necessary to change any variables.

### A Sample Printout

Now, let's look at the sample data printout. You can see that the first section of the printout deals with the electric bill summary. The next sections are for the gas bill and the water bill summaries. These list the data for the months you have entered. In these examples, I have used the actual data from my 1981 utility bill records. When you run this program, the computer will prompt you for the inputs in the same order as they are listed in the sample printout headers.

The final section is the summary for all utility costs. It prints out an amount for each utility for all 12 months, even if you have not made any entries for those months. The screen printout will be similar to the hardcopy, except that it will be in an abbreviated format and will list cost, usage and totals on three separate pages. This is because of the small screen size.

//

## ELECTRIC BILL SUMMARY

//

MONTH	METER PRESENT	READINGS PREVIOUS	ELECTRIC USEAGE	ELECTRIC CHARGE	FUEL ADJUST	STATE TAX	ELECTRIC TOTAL
JAN	27589	26833	756	\$ 42.22	\$14.17	\$ 2.26	\$ 58.65
FEB	28212	27589	623	\$ 35.42	\$ 6.23	\$ 1.67	\$ 43.32
MAR	28854	28212	642	\$ 39.29	\$ 5.69	\$ 1.80	\$ 46.78
APR	29537	28854	683	\$ 41.58	\$ 9.67	\$ 2.05	\$ 53.30
MAY	30180	29537	643	\$ 39.35	\$10.79	\$ 2.01	\$ 52.15
JUN	30902	30180	722	\$ 42.34	\$11.61	\$ 2.16	\$ 56.11
JUL	31720	30902	818	\$ 48.54	\$12.67	\$ 2.14	\$ 63.35
AUG	32499	31720	779	\$ 46.51	\$12.06	\$ 2.05	\$ 60.62
SEP	33217	32499	718	\$ 43.15	\$ 9.90	\$ 1.86	\$ 54.91
OCT	33878	33217	661	\$ 46.95	\$ 0.39	\$ 1.66	\$ 49.00
NOV	34494	33878	616	\$ 43.89	\$ 5.14	\$ 1.72	\$ 50.75
DEC	35265	34494	771	\$ 54.43	\$ 5.65	\$ 2.10	\$ 62.18
<b>TOTALS</b>			<b>8432</b>	<b>\$523.67</b>	<b>\$103.97</b>	<b>\$23.48</b>	<b>\$651.12</b>



\*\*\*\*\*  
**GAS BILL SUMMARY**  
 \*\*\*\*\*

MONTH	METER PRESENT	READINGS PREVIOUS	GAS USAGE	GAS SERVICE	GAS COST	STATE TAX	GAS TOTAL
JAN	3829	3664	165	\$ 14.69	\$33.71	\$ 1.94	\$ 50.34
FEB	3971	3829	142	\$ 12.97	\$27.28	\$ 1.61	\$ 41.86
MAR	4095	3971	124	\$ 11.61	\$24.14	\$ 1.43	\$ 37.18
APR	4191	4095	96	\$ 9.46	\$19.74	\$ 1.17	\$ 30.37
MAY	4231	4191	40	\$ 5.25	\$ 9.16	\$ 0.54	\$ 13.95
JUN	4264	4231	33	\$ 4.74	\$ 7.01	\$ 0.47	\$ 12.22
JUL	4293	4264	29	\$ 4.48	\$ 6.47	\$ 0.38	\$ 11.33
AUG	4326	4293	33	\$ 5.23	\$ 7.46	\$ 0.44	\$ 13.13
SEP	4360	4326	34	\$ 5.34	\$ 7.98	\$ 0.46	\$ 13.68
OCT	4394	4360	34	\$ 5.34	\$ 8.19	\$ 0.47	\$ 14.00
NOV	4404	4394	90	\$ 32.13	\$ 0.00	\$ 1.12	\$ 33.25
DEC	4618	4404	134	\$ 14.42	\$34.33	\$ 1.71	\$ 50.46
TOTALS			954	\$125.66	\$184.29	\$11.74	\$321.69

\*\*\*\*\*  
**WATER BILL SUMMARY**  
 \*\*\*\*\*

MONTH	METER PRESENT	READINGS PREVIOUS	WATER USAGE	WATER CHARGE	SEWER CHARGE	STATE TAX	UTILITY TOTAL
JAN	22	9	13	\$ 6.53	\$ 6.39	\$ 0.26	\$ 13.18
FEB	36	22	14	\$ 8.43	\$ 4.93	\$ 0.34	\$ 13.70
MAR	47	36	11	\$ 7.32	\$ 4.93	\$ 0.29	\$ 12.54
APR	69	47	22	\$ 11.39	\$ 5.81	\$ 0.46	\$ 17.66
MAY	117	69	48	\$ 21.01	\$ 5.81	\$ 0.84	\$ 27.66
JUN	163	117	46	\$ 20.27	\$ 5.81	\$ 0.81	\$ 26.89
JUL	227	163	64	\$ 28.25	\$ 5.81	\$ 1.01	\$ 35.07
AUG	281	227	54	\$ 24.85	\$ 5.81	\$ 0.87	\$ 31.53
SEP	337	281	56	\$ 25.65	\$ 5.81	\$ 0.90	\$ 32.36
OCT	389	337	51	\$ 23.65	\$ 5.81	\$ 0.83	\$ 30.29
NOV	489	389	21	\$ 11.65	\$ 5.81	\$ 0.41	\$ 17.87
DEC	419	489	18	\$ 7.25	\$ 5.16	\$ 0.23	\$ 12.64
TOTALS			410	\$196.25	\$ 67.89	\$ 7.27	\$271.41

\*\*\*\*\*  
**UTILITY BILL SUMMARY**  
 \*\*\*\*\*

MONTH	ELECTRIC TOTAL	GAS TOTAL	WATER TOTAL	UTILITY TOTAL
JAN	\$ 50.34	\$ 50.34	\$ 13.18	\$ 122.17
FEB	\$ 43.32	\$ 41.86	\$ 13.70	\$ 98.88
MAR	\$ 46.78	\$ 37.18	\$ 12.54	\$ 96.50
APR	\$ 53.30	\$ 30.37	\$ 17.66	\$ 101.33
MAY	\$ 52.15	\$ 13.95	\$ 27.66	\$ 93.76
JUN	\$ 56.11	\$ 12.22	\$ 26.89	\$ 95.22
JUL	\$ 63.35	\$ 11.33	\$ 35.07	\$ 109.75
AUG	\$ 60.62	\$ 13.13	\$ 31.53	\$ 105.28
SEP	\$ 54.91	\$ 13.68	\$ 32.36	\$ 100.97
OCT	\$ 49.00	\$ 14.00	\$ 30.29	\$ 93.29
NOV	\$ 50.75	\$ 33.25	\$ 17.87	\$ 101.87
DEC	\$ 62.18	\$ 50.46	\$ 12.66	\$ 125.30
TOTALS				\$1244.22

**Program Requirements**

The program will run with 16K of RAM if the *REMARKS* are deleted. It requires Extended Basic only because of the *PRINT USING* statements. If you change these statements, you can run without Extended Basic.

The program was written to be used with a Line Printer VII. I have used printer control codes for those who wish to use this program with another type of printer. The codes are set in lines 1130 and 1140. Look at the following table for a list of the code functions:

- Printer Code Functions  
 C1\$=LINE FEED  
 C2\$=NORMAL WIDTH PRINT  
 C3\$=DOUBLE WIDTH PRINT  
 C4\$=FIVE LINE FEEDS  
 C5\$=DOUBLE WIDE HEADER  
 C6\$=80 COLUMN LINE  
 C7\$=FOR SCREEN PRINT

If your printer has a form-feed function, you can change C4\$ to the code for FORM FEED (CHR\$(12)). Change C6\$ to reflect the column width of your printer. You should use at least an 80 column printer if you do not wish to make major program modifications. Also, change C2\$ and C3\$ to the values required for your printer.

You *must* enter the bills in chronological order; enter the January electric bill before entering the February electric bill. You can enter all of the electric bills before entering either gas or water bills or vice versa. If you enter the months out of order, the data on the summary sheets will also be out of order. The program matches the name of the month to the months listed in the data statements in the program to determine if the month was entered properly. If not, you will get a tone and a flashing warning and you will have to re-enter the month.

When you enter the actual cost of the utilities, do not use dollar signs (\$). The program will automatically enter them for you.

**Editing Data**

The program has no editor, but you can edit data by breaking the program and changing the incorrect variable. For example, assume that the electric charge for the March entry was incorrect. It shows that the electric charge was \$39.29. Now, if you wanted to change it to \$38.29, you would start by pressing *BREAK*. Look at the program listing. Entries for the electric bill start at line 1430. When you ran the program, you saw that the month of the bill is entered first followed by the base electric charge. Starting at line 1430, the first *INPUT* statement is E1\$(E9) for the month. The second *INPUT* statement is E2(E9) for the electric charge. Since March is the third month, E9 will equal three. After you press *BREAK*, type the following to change the data

E2(3)=38.29:CONT

This will change the electric charge from \$39.29 to \$38.29 and restart the program. Press *ENTER* again to call the error routine, then answer the prompts. This type of data editing will work for all programs written in Basic as long as you don't have a syntax error. If you attempt to *RUN* the program instead of *CONTinuing* it, or, if you have a syntax error, the program pointers will be reset and the data will be lost.

**A Final Word**

The program is simple to use once you become familiar with it so give it a try after you have loaded it and saved a copy to tape. Try all combinations of inputs and check for error handling to insure that you have loaded it correctly.

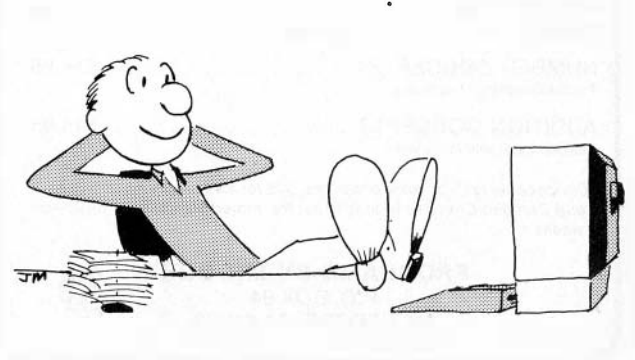

When you are ready to use it for keeping your records, you will see how easy it will be to budget the utility bills. You will also have a program that your friends and neighbors might find useful. They will see that you can use your computer for much more than just playing games.

1320	03BA
1570	05E8
1960	092D
2440	0DD5
2910	1269
3380	1706
3970	1CD2
4440	20BC
4660	2265
5100	27CC
5400	2BC5
END	30A7

The listing:

```

1000 ' HOME UTILITY PROGRAM
1010 ' BY
1020 ' DENNIS H. WEIDE
1030 ' (C) 1982
1040 '
1050 '
1060 '

```

## PARENTS & TEACHERS

of children ages 3 to 8

Software written by School Director to utilize computer as an aid in teaching Early Childhood Concepts. Puts fun & excitement into learning.

Requires 16K ext. basic & Joysticks.

COMPUTER LITERACY ..... \$14.95

Introduces computer age terms & concepts to parents & teachers. Audio/visual.

CREATE ..... \$9.95

Use of colors & sounds fascinates all ages. Uses Joysticks to DRAW.

HAND/EYE COORDINATION ..... \$14.95

Guide spaceship thru maze. 13 learning levels. Challenge to all ages.

RECOGNITION ..... \$14.95

Child learns to recognize "like" figures. 2 separate games. Many learning levels.

Following Programs USE VOICE RECORDED EXPLANATIONS & GAMES IN FUN & EXCITING WAY:

PERCEPTION ..... \$14.95

Teaches antonyms, i.e. left/right, first/last, etc.

NUMBER CONCEPTS ..... \$14.95

Teaches meaning of numbers.

ADDITION CONCEPTS ..... \$14.95

Teaches basic arithmetic skills.

20% discount for 3 or more programs; \$75 for all 7 programs.

Send Certified Check or money order for immediate delivery; otherwise 2 weeks.

PROGRAMS BY MR. BOB

P.O. BOX 94  
MONTROSE, CA 91020



```

1070 ' INITIALIZE PROGRAM
1080 '
1090 '
1100 CLS: CLEAR 300
1110 H1$="MONTH OF BILL"
1120 H2$="YEAR-TO-DATE SUMMARY"
1130 C1$=CHR$(10):C2$=CHR$(30):C
3$=CHR$(31):C4$=STRING$(5,10)
1140 C5$=STRING$(40,"%"):C6$=STR
ING$(80,"-"):C7$=STRING$(32,"=")
1150 DIM D2$(12),E1$(12),E2(12),
E3(12),E4(12),E9(12)
1160 DIM E5(12),E6(12),TU(12),W1
(12)
1170 DIM G1$(12),G2(12),G3(12),G
4(12),G5(12),G6(12)
1180 DIM W1$(12),W2(12),W3(12),W
4(12),W5(12),W6(12)
1190 FOR X=1 TO 12:READ D2$(X):N
EXT X
1200 CLS:PRINTTAB(5)"UTILITY BIL
LS PROGRAM"
1210 Q=3:PRINT
1220 PRINTTAB(Q)"1. ENTER ELECTRI
C BILLS"
1230 PRINTTAB(Q)"2. ENTER GAS BIL
LS"
1240 PRINTTAB(Q)"3. ENTER WATER B
ILLS"
1250 PRINTTAB(Q)"4. SUMMARIZE ELE
CTRIC BILLS"
1260 PRINTTAB(Q)"5. SUMMARIZE GAS
BILLS"
1270 PRINTTAB(Q)"6. SUMMARIZE WAT
ER BILLS"
1280 PRINTTAB(Q)"7. SUMMARIZE UTI
LITY BILLS"
1290 PRINTTAB(Q)"8. LOAD DATA FRO
M TAPE"
1300 PRINTTAB(Q)"9. SAVE DATA TO
TAPE"
1310 PRINTTAB(Q)"10. PRINT TO PRI
NTER"
1320 PRINTTAB(Q)"11. END RUN OF P
ROGRAM"
1330 GOSUB 3760: INPUT A
1340 ON A GOTO 1430,1630,1830,20
20,2500,2970,3440,4030,4280,4720
,5780
1350 CLS:GOSUB 3820:GOTO 1200
1360 GOSUB 3820
1370 GOTO 1200
1380 '
1390 '
1400 ' ELECTRIC BILL ENTRY
1410 '
1420 '
1430 CLS:PRINT:PRINTTAB(6)"ELECT
RIC BILL ENTRY"
1440 E9=E9+1:PO=0

```

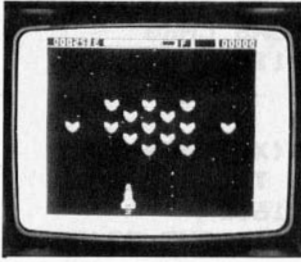

### ASTRO BLAST

Your routine space patrol in an outer galaxy sector becomes a life and death struggle with alien invasion forces advancing towards Earth. Wave after wave of attack squadrons challenge you in this super hi-res machine language shoot-em-up game. One or two players. 16K.

Tape version..... \$24.95

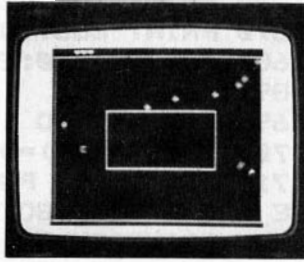

### SPACE RACE

Maneuver your ship around the four cornered "race track" in space while destroying hordes of alien ships. As you fly around the "race track" bouncing off the walls, watch out for mines laid by the swarms. Great color and sound and a new approach. 16K.

Tape..... \$21.95

# 20+24 = 1



**YES THATS RIGHT 20 PLUS 24 EQUALS 1. TRANSLATED THAT MEANS 20% DISCOUNT ON SOFTWARE ORDERS OF 4 OR MORE ITEMS PLUS 24 HOUR DELIVERY MAKE US YOUR #1 DEALER. TRY US AND SEE! WE HAVE OVER 50 DIFFERENT PROGRAMS FOR THE COLOR COMPUTER.**

### SPACE TRADER

Establish vast interstellar shipping lanes and purchase stock in the companies that control those trade routes. This is a multi-player board game with graphics. This is a game for the thinkers, it takes more than a quick hand to win this one. 16K

Tape..... \$21.95

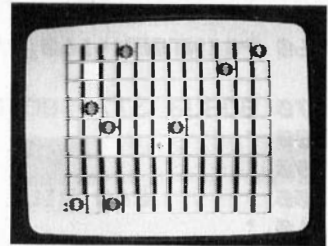

### PLANET INVASION

A great new Defender action game, its success insured by its spellbinding graphics and marvelous sound, but most of all by its controlability. Using both the keyboard and the joystick, you maneuver your way through this revolutionary new game. 16K

Tape..... \$21.95

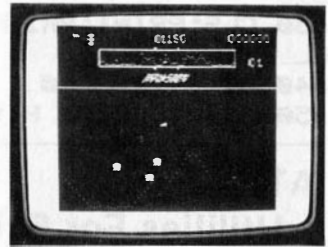

### VENTURER

Fantastic arcade game comes to life on your Color Computer screen. Upon entering each room you'll find new treasures and new challenges. Using your joystick, get the treasure while fending off the attacking creatures. This great new adaptation be Aardvark will put excitement back into your Color Computer. 16K

Tape..... \$19.95

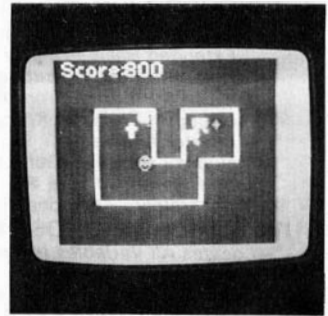

### GOLF

Aardvark has brought this age old game to your Color Computer. With sandtraps, trees, water holes, and a great sound track, you just might mistake it for the real thing. Choose your club and select a swing, if you make it to the green you can even putt. 16K extended color basic.

Tape..... \$9.95

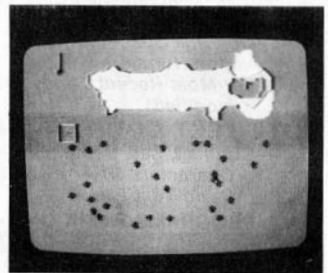

Four great reasons why you should buy from Computer Shack (1) We have a toll free line. it costs you nothing to call us. (2) We ship all orders out within 24 hours (3) Most of our salespeople have color computers and they will be more than happy to help you pick out games, books, etc. (4) If you buy more than one program we will give you a discount. If you buy 2 programs you can take 10% off both programs. If you buy 3 programs you can take 15% off, and if you buy 4 or more programs you can take 20% off the price of all four.

We are still in need of some additional people to add to our top ten panel. If you are interested send us a listing of your 10 favorite games.

We carry many programs that are not in our ad's. please call if there is a special program you want.

### MONKEY KONG

Once again, Mario jumps into action. Avoiding rolling barrels, ramps, ladders, and killer flames while trying to save the beautiful girl from the clutches of the giant ape. Written by Ken Kalish its so much like the arcade version, you might try to insert a quarter. 16K.

Tape..... \$19.95

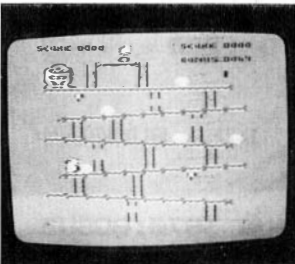

### RAIL RUNNER

Something like Frogger™. But with a difference. Excellent hi res graphics and exciting play.

From Computerware.

Tape... \$21.95 Disk... \$26.95



## COMPUTER SHACK

1691 Eason • Pontiac, Michigan 48054

Info: (313) 873-8700 • Orders: CALL TOLL FREE (800) 392-8881

Master Charge and VISA OK. Please add \$3.00 for shipping in the U.S.A. - \$5.00 for Canada or Mexico - Proper postage outside of U.S. - Canada - Mexico. Dealers: We are distributors for all items in this ad. Write for our catalog and price list.



```

1450 PRINT:PRINT H1$
1460 PRINT"BASE ELECTRIC CHARGE"
1470 PRINT"FUEL ADJUSTMENT"
1480 GOSUB 4610:EM=118:INPUT E1$
(E9)
1490 FOR X=1 TO 12:IF E1$(E9)=D2
$(X) THEN PO=1
1500 NEXT X:IF PO=1 THEN 1520
1510 GOSUB 3820:GOTO 1430
1520 PRINT@EM+32,"";:INPUT E2(E9
)
1530 PRINT@EM+64,"";:INPUT E3(E9
)
1540 PRINT@EM+96,"";:INPUT E4(E9
)
1550 PRINT@EM+128,"";:INPUT E5(E
9)
1560 PRINT@EM+160,"";:INPUT E6(E
9)
1570 GOSUB 3770:GOTO 1200
1580 '
1590 '
1600 '      GAS BILL ENTRY
1610 '
1620 '
1630 CLS:PRINT:PRINTTAB(9)"BAS B
ILL ENTRY"
1640 G9=89+1:PO=0
1650 PRINT:PRINT H1$

```

```

1660 PRINT"GAS SERVICE CHR$"
1670 PRINT"COST OF GAS CHR$"
1680 GOSUB 4610:EM=118:INPUT G1$
(G9)
1690 FOR X=1 TO 12
1700 IF G1$(G9)=D2$(X) THEN PO=1
1710 NEXT X:IF PO=1 THEN 1720 EL
SE GOSUB 3820:GOTO 1630
1720 PRINT@EM+32,"";:INPUT G2(G9
)
1730 PRINT@EM+64,"";:INPUT G3(89
)
1740 PRINT@EM+96,"";:INPUT G4(G9
)
1750 PRINT@EM+128,"";:INPUT G5(G
9)
1760 PRINT@EM+160,"";:INPUT G6(G
9)
1770 GOSUB 3770:GOTO 1200
1780 '
1790 '
1800 '      WATER BILL ENTRY
1810 '
1820 '
1830 CLS:PRINT:PRINTTAB(8)"WATER
BILL ENTRY"
1840 W9=W9+1:PO=0
1850 PRINT:PRINT H1$
1860 PRINT"BASE WATER CHARGE"
1870 PRINT"SEWER CHARGE"
1880 GOSUB 4610:WM=118:INPUT W1$
(W9)
1890 FOR X=1 TO 12:IF W1$(W9)=D2
$(X) THEN PO=1
1900 NEXT X:IF PO=1 THEN 1910 EL
SE GOSUB 3820:GOTO 1830
1910 PRINT@WM+32,"";:INPUT W2(W9
)
1920 PRINT@WM+64,"";:INPUT W4(W9
)
1930 PRINT@WM+96,"";:INPUT W5(W9
)
1940 PRINT@WM+128,"";:INPUT W6(W
9)
1950 PRINT@WM+160,"";:INPUT W1(W
9)
1960 GOSUB 3770:GOTO 1200
1970 '
1980 '
1990 '      ELECTRIC BILL SUMMARY
2000 '
2010 '
2020 GOSUB 2440:GOSUB 3870:GOSUB
3760:INPUT A
2030 ON A GOTO 2050,2190,2320,12
00
2040 GOSUB 3820:GOTO 2020
2050 GOSUB 2440
2060 PRINT"MON  CHRG  FUADJ
TAX  TOTAL"

```

## AT LAST . . .

### Utilities For Extended Basic!

#### #UK2 COLOR KRUNCHER — \$9.95

- Reduces Memory Requirements Of Any Extended Basic Program
- Speeds Program Execution Time
- Type In A Program From A Magazine, As Is, Debug It, Then Let Kruncher Make It Shorter And Faster
- Includes LN.XREF—Get A Sorted Listing Of All Referenced Line #'s — Can Be Used Separately — Optional Printer Output

#### #UV4 VARIABLE CROSS REFERENCE — \$6.95

- Locates All Variables In Your Extended Basic Program
- Automatic Sort—Optional Printer Output

#### #UF2 LLIST FORMATTER — \$6.95

- User-selectable Margins, Page Lengths, Top-of-forms and More
- Optional Space Between Lines—Highlights Line Numbers
- For Most Recent Tandy Printers (can be user modified).

#### #UT2 TEXT COUNT — \$5.95

- Counts Lines, Sentences, Words, Total Characters Of Any ASCII-Saved Extended Basic Text File

ALL PROGRAMS WORK ON EXT. BASIC TAPE OR DISK!!!  
**Buy Two Or More On The Same Order And Take 10% Off**  
 Send Check Or Money Order To: (Pa. Residents Add 6%)  
 (Postage paid in U.S. and Canada)

### MICROLOGIC

Box 193, 1st Avenue  
 East Brady, PA 16028

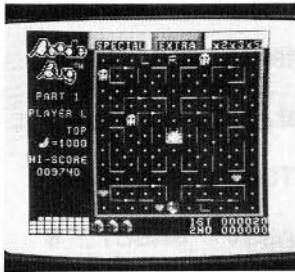

## DOODLE BUG

DOODLE BUG is a machine language high resolution graphics game for one or two players who move their Ladybugs through an ever-changing maze gobbling dots and other items while avoiding enemy bugs and Skulls. Excellent Graphics. Similar to Lock N' Chase™. Tape... **\$24.95** Disk... **\$29.95**

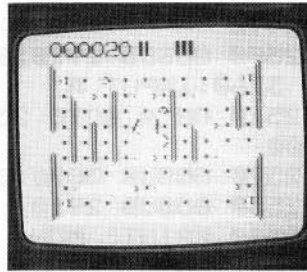

## PACDROIDS

With its space theme, the Super Saucer lays destructomines and the Super Bomb that disintegrates everything in your path, right up to the wall. The maze changes every 10,000 points as the difficulty escalates. 1-4 players. 16K extended basic. Tape..... **\$19.95**



## COLORPEDE

Colorpede has a variety of bugs ranging from a tiny beetle to the gigantic colorpede. Colorpede has better graphics than Katerpillar but the sound is not as good. Colorpede also has a more varied and complicated play routine. 16K. Tape..... **\$29.95**



## DONKEY KING

Using the four stages from the original arcade game, with your joystick in hand try to jump the barrels, collect the pins, manuever your way past the falling jacks, and figure out the crazy conveyor belts. Written by Tom Mix, this ones sure to become a classic! 32K. Tape... **\$24.95** Disk... **\$27.95**

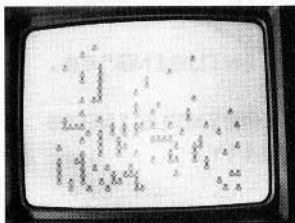

## MEGAPEDA

Could this be the best Centipede yet? Computerwares new addition to the field, super graphics and sound. Tape... **\$21.95** Disk... **\$26.95**

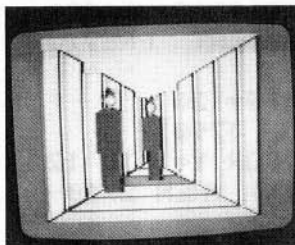

## PHANTOM SLAYER

You must chase the phantoms and kill them with your assortment of weapons. This is a graphics type maze/adventure game with full screen three dimensional graphics. You are armed with a laser pistol, and proximity detector. 16K. Tape..... **\$19.95**

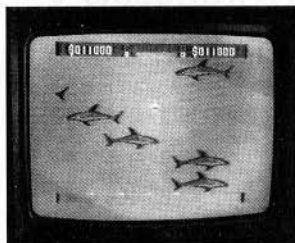

## SHARK TREASURE

Dive down through the sharks and salvage the gold. Armed with special flash bombs you fight off the sharks. Excellent game. Great graphics, sound. From Computerware. Tape... **\$21.95** Disk... **\$26.95**

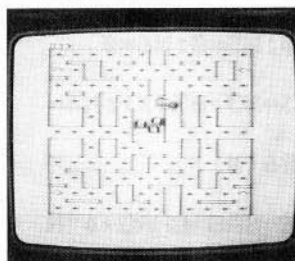

## GHOST GOBBLER

Ghost Gobbler is an excellent version of Pac-Man™. You must gobble all the food dots while avoiding the ghosts. There are four energizer dots which will make the ghosts turn blue and become scared. This is the best copy of the arcade game. 16K. Tape..... **\$21.95**

Now you can deduct up to 20% on the price of games: buy any 2 games deduct 10%, buy any 3 games deduct 15%, buy any 4 games deduct 20% from games prices.

### TOP TEN

- 1.) **DONKEY KING** by Tom Mix
- 2.) **COLORPEDE** by Intracolor
- 3.) **ASTRO BLAST** by Mark Data
- 4.) **DOODLE BUG** by Computerware
- 5.) **SPACE RACE** by Spectral Assoc.
- 6.) **PLANET INVASION** by Spectral Assoc.
- 7.) **PACDROIDS** by Programmers Guild
- 8.) **STARFIRE** by Inteltronics
- 9.) **HAYWIRE** by Mark Data
- 10.) **KATERPILLAR ATTACK** by Tom Mix

## INVADERS REVENGE

You, as the last remaining space Invader, must battle the human ships that prowl the space lanes, and avoid the laser station that seeks to destroy you. A great game from Med. Systems. Reverses the roll in space invaders you attack the laser bases. 16K. Tape..... **\$19.95**

## HAYWIRE

This is Mark Data's version of Beserk™. Super Colors and dynamite sound effects in this fast paced arcade game for one or two players. The exciting combination of angry robots and the Indestructible Menace will provide hours of action filled fun. Tape..... **\$24.95**

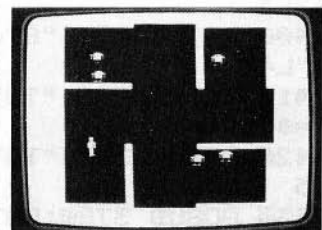

# COMPUTER SHACK

1691 Eason • Pontiac, Michigan 48054

Info: **(313) 873-8700** • Orders: **CALL TOLL FREE (800) 392-8881**

Master Charge and VISA OK. Please add \$3.00 for shipping in the U.S.A. - \$5.00 for Canada or Mexico - Proper postage outside of U.S. - Canada - Mexico. **Dealers:** We are distributors for all items in this ad. Write for our catalog and price list.

```

2070 PRINT C7$:D=97:GOSUB 3790
2080 M1=69:M2=76:M3=83:M4=88
2090 FOR X=1 TO 12
2100 M1=M1+32:M2=M2+32:M3=M3+32:
M4=M4+32
2110 FOR Y=1 TO 12
2120 IF E1$(Y)=D2$(X) THEN 2130
ELSE 2170
2130 PRINT@M1,"";:PRINTUSING"###
.###";E2(Y)
2140 PRINT@M2,"";:PRINTUSING"###
.###";E3(Y)
2150 PRINT@M3,"";:PRINTUSING"###
.###";E4(Y)
2160 PRINT@M4+2,"";:PRINTUSING"$
###.###";E2(Y)+E3(Y)+E4(Y);
2170 NEXT Y,X
2180 GOSUB 3780:GOTO 2020
2190 CLS:PRINTTAB(12)"KWH USED"
2200 PRINT" MON PRESENT PREVIO
US USED"
2210 L7=101:L8=110:L9=120
2220 PRINT C7$:GOSUB 3790
2230 FOR X=1 TO 12
2240 FOR Y=1 TO 12
2250 IF E1$(Y)=D2$(X) THEN 2260
ELSE 2290
2260 PRINT@L7+2,"";:PRINTUSING"$
####";E5(Y)
2270 PRINT@L8+3,"";:PRINTUSING"$
####";E6(Y)
2280 PRINT@L9,"";:PRINTUSING"###
###";E5(Y)-E6(Y)
2290 NEXT Y:L7=L7+32:L8=L8+32:L9
=L9+32
2300 NEXT X
2310 GOSUB 3780:GOTO 2020
2320 GOSUB 4660
2330 L2=0:L3=0:L4=0:L5=0:L6=0
2340 FOR X=1 TO 12
2350 L2=L2+E2(X):L3=L3+E3(X):L4=
L4+E4(X)
2360 L5=L5+(E5(X)-E6(X))
2370 NEXT X
2380 PRINT@99,"BASE ELECT. CHRGE=
$"L2
2390 PRINT@163,"FUEL ADJUSTMENT=
$"L3
2400 PRINT@227,"STATE SALES TAX=
$"L4
2410 PRINT@291,"TOTAL ELECT. COS
T=$"L2+L3+L4
2420 PRINT@355,"TOTAL KWH USED="
L5
2430 GOSUB 3780:GOTO 2020
2440 CLS:PRINTTAB(5)"ELECTRIC BI
LL SUMMARY":RETURN
2450 '
2460 '

```

```

2470 ' GAS BILL SUMMARY
2480 '
2490 '
2500 GOSUB 2910:GOSUB 3870:GOSUB
3760:INPUT A
2510 ON A GOTO 2530,2670,2790,12
00
2520 GOSUB 3820:GOTO 2500
2530 GOSUB 2910
2540 PRINT" MON GASSV GASCT S
TAX TOTAL"
2550 PRINT C7$:D=97:GOSUB 3790
2560 M1=69:M2=76:M3=83:M4=88
2570 FOR X=1 TO 12
2580 M1=M1+32:M2=M2+32:M3=M3+32:
M4=M4+32
2590 FOR Y=1 TO 12
2600 IF G1$(Y)=D2$(X) THEN 2610
ELSE 2650
2610 PRINT@M1,"";:PRINTUSING"###
.###";G2(Y)
2620 PRINT@M2,"";:PRINTUSING"###
.###";G3(Y)
2630 PRINT@M3,"";:PRINTUSING"###
.###";G4(Y)
2640 PRINT@M4+1,"";:PRINTUSING"$
###.###";G2(Y)+G3(Y)+G4(Y)
2650 NEXT Y,X
2660 GOSUB 3780:GOTO 2500
2670 CLS:PRINTTAB(12)"GAS USAGE"
2680 PRINT" MON PRESENT PREVIO
US USED"
2690 F7=101:F8=110:F9=120
2700 PRINT C7$:GOSUB 3790
2710 FOR X=1 TO 12:FOR Y=1 TO 12
2720 IF G1$(Y)=D2$(X) THEN 2730
ELSE 2760
2730 PRINT@F7+2,"";:PRINTUSING"$
####";G5(Y)
2740 PRINT@F8+3,"";:PRINTUSING"$
####";G6(Y)
2750 PRINT@F9,"";:PRINTUSING"###
###";G5(Y)-G6(Y)
2760 NEXT Y
2770 F7=F7+32:F8=F8+32:F9=F9+32
2780 NEXT X:GOSUB 3780:GOTO 2500
2790 GOSUB 4660
2800 N2=0:N3=0:N4=0:N5=0:N6=0
2810 FOR X=1 TO 12
2820 N2=N2+G2(X):N3=N3+G3(X):N4=
N4+G4(X)
2830 N5=N5+(G5(X)-G6(X))
2840 NEXT X
2850 PRINT@99,"BASE GAS CHRGE=$"N
2
2860 PRINT@163,"COST OF GAS CHRGE
=$"N3
2870 PRINT@227,"STATE SALES TAX=
$"N4

```



# - COMPUTER SHACK -

## COLOR DFT (Direct File Transfer) Disk or Tape

At last a terminal program for the color computer that allows you to send and receive machine language programs without any conversion routines. Send directly from disk to disk or tape to disk. DFT will send and receive any type of program machine language, basic, text files, data files etc. from a color computer, Model I, Model III or a Bullet 80 system. DFT has a chat mode and has software controlled half and/or full duplex. You must have a modem in order to use DFT.

Tape Version ..... **\$24.95** Disk Version ..... **\$29.95**

## COLOR TAPE COPY \$15.95

By Bob Withers

There have been few copy programs on the market for the Color computer but none can compare with Color Tape Copy. This program is designed so that you don't lose any of your valuable programs or data bases.

It will make a backup of any Color Computer Tape; Machine language, data, or basic program.

First load color tape copy into your CC. Then it prompts you to put your original copy into the recorder. After it loads the program into memory it tells you to put a blank tape into the recorder and press the record button. It then writes the program to a new tape.

You'll never have to worry about your little kids destroying your \$20.00 tapes. 16K.

## TELEWRITER - 64

Best word processor for the Color Computer.

Tape ..... **\$49.95** Disk ..... **\$59.95**

## DRAGONQUEST

A new text adventure by Charles Forsythe. You must rescue the princess from the Smaeagor Monarch of Dragonfolk. All Machine language. Fast, Exciting and only..... **\$15.95**

## MADNESS AND THE MINOTAUR

A classic adventure game utilizing two word commands.

Price ..... **\$19.95**

## BUGOUT

A compact but very powerful monitor for the 6809 microprocessor. Only..... **\$19.95**

## MISADVENTURE SERIES

### MADAM ROSA'S MASSAGE PARLOR

Tape ..... **\$15.00**

### WET T-SHIRT CONTEST

Tape ..... **\$15.00**

## COMPUTER SHACK'S BOOK STORE

### PROGRAMMING THE 6809

By Rodney Zaks & William Labiak

**\$14.95**

This book explains how to program the 6809 in assembly language, covering all aspects progressively and systematically. Beginning with the basics of programming, **Programming the 6809** goes on to explain registers and buses, subroutines, the 6809 instruction set, addressing modes, I/O techniques and devices, and finally, data structures. With this knowledge you will be able to give your 6809 processor 16-bit performance with 8-bit economy. No prior programming knowledge is required.

### TRS-80 COLOR PROGRAMS

by Tom Rugg and Phil Feldman

**\$19.95**

Here are 37 fully documented programs ready to type into your color computer. These programs promise to be educational, practical, and in almost all cases, fun. 332 pages.

### COLOR COMPUTER GRAPHICS

by Ron Clark

**\$9.95**

The complete handbook on how to do color video graphics, with ready to run programs. Learn all about low, medium and high-resolution graphics, and how to create each. 138 pages.

### TRS-80 COLOR BASIC

by Bob Albrecht

**\$9.95**

With this book you can teach yourself BASIC, the language of the TRS-80 and many other computers. Packed with games, experiments, programming problems and solutions, this entertaining self-instructional book is the ideal introductory aid for kids, parents and teachers. 378 pages.

### TRS-80 COLOR COMPUTER GRAPHICS

by Don Inman

**\$14.95**

Explore the creative and imaginative blending of computers and color using Color Computer Graphics. This book will enable you to explore all the graphics capabilities of Extended Basic. you will learn how to create interesting graphics to enhance your own computer programs. The book also provides application programs and useful subroutines. 303 pages

### COLOR COMPUTER SONGBOOK

by Ron Clark

**\$7.95**

40 of the world's best known songs, scored for easy playing on the TRS-80 Color Computer, including many favorite popular, classical, folk and seasonal musical selections. Some of which include Dixie, Minuet, Greensleeves, Jingle Bells, Yellow Rose of Texas, etc. 96 pages

# COMPUTER SHACK

1691 Eason • Pontiac, Michigan 48054

Info: (313) 873-8700 • Orders: CALL TOLL FREE (800) 392-8881

Master Charge and VISA OK. Please add \$3.00 for shipping in the U.S.A. - \$5.00 for Canada or Mexico - Proper postage outside of U.S. - Canada - Mexico.  
Dealers: We are distributors for all items in this ad. Write for our catalog and price list.

```

2880 PRINT@291,"TOTAL GAS COST=$
"N2+N3+N4
2890 PRINT@355,"TOTAL UNITS USED
="N5
2900 GOSUB 3780:GOTO 2500
2910 CLS:PRINTTAB(8)"GAS BILL SU
MMARY":RETURN
2920 '
2930 '
2940 '      WATER BILL SUMMARY
2950 '
2960 '
2970 GOSUB 3380:80SUB 3870:GOSUB
3760:INPUT A
2980 ON A GOTO 3000,3130,3260,12
00
2990 GOSUB 3820:GOTO 2970
3000 GOSUB 3380
3010 PRINT"MON  WATER SEWER T
AX  TOTAL"
3020 PRINT C7$:D=97:GOSUB 3790
3030 M1=69:M2=76:M3=83:M4=88
3040 FOR X=1 TO 12
3050 M1=M1+32:M2=M2+32:M3=M3+32:
M4=M4+32
3060 FOR Y=1 TO 12
3070 IF W1$(Y)=D2$(X) THEN 3080
ELSE 3120
3080 PRINT@M1,"";:PRINTUSING"###

```

```

.###";W2(Y)
3090 PRINT@M2+1,"";:PRINTUSING"$
#.###";W4(Y)
3100 PRINT@M3,"";:PRINTUSING"$#.
###";W5(Y)
3110 PRINT@M4+1,"";:PRINTUSING"$
###.###";W2(Y)+W4(Y)+W5(Y);
3120 NEXT Y,X:GOSUB 3780:GOTO 29
70
3130 CLS:PRINTTAB(6)"UNITS OF WA
TER USED"
3140 PRINT" MON  PRESENT  PREVIO
US  USED"
3150 P7=103:P8=113:P9=120
3160 PRINT C7$:GOSUB 3790
3170 FOR X=1 TO 12:FOR Y=1 TO 12
3180 IF W1$(Y)=D2$(X) THEN 3190
ELSE 3220
3190 PRINT@P7,"";:PRINTUSING"###
#";W6(Y)
3200 PRINT@P8,"";:PRINTUSING"###
#";W1(Y)
3210 PRINT@P9,"";:PRINTUSING"###
#";W6(Y)-W1(Y)
3220 NEXT Y
3230 P7=P7+32:P8=P8+32:P9=P9+32
3240 NEXT X
3250 GOSUB 3780:GOTO 2970
3260 GOSUB 4660
3270 P2=0:P4=0:P5=0:P6=0
3280 FOR X=1 TO 12
3290 P2=P2+W2(X):P4=P4+W4(X):P5=
P5+W5(X)
3300 P6=P6+(W6(X)-W1(X))
3310 NEXT X
3320 PRINT@99,"BASE WATER CHR0=$
"P2
3330 PRINT@163,"SEWER CHARGE=$"P
4
3340 PRINT@227,"STATE SALES TAX=
$"P5
3350 PRINT@291,"TOTAL WATER COST
=$"P2+P3+P4+P5
3360 PRINT@355,"TOTAL UNITS USED
="P6
3370 GOSUB 3780:GOTO 2970
3380 CLS:PRINTTAB(6)"WATER BILL
SUMMARY":RETURN
3390 '
3400 '
3410 '      UTILITY BILLS SUMMARY
3420 '
3430 '
3440 CLS:PRINTTAB(6)"SUMMARY OF
UTILITITES"
3450 PRINT"MON  ELECT  GAS  WA
TER  TOTAL"
3460 PRINT C7$
3470 FOR X=1 TO 12

```

## NEW SOFTWARE for TRS 80 Model III and the Color Computer

### ■ Church Contribution System

designed to simplify and facilitate the tedious chore of recording envelopes. Provides a variety of reports. Maintains its own data-files. Only **\$150**

### ■ Data Base Manager

designed to help organize all your data and provide you with meaningful reports. Add or delete any information. New files can be created and old information transferred. Only **\$150**

### ■ Single Entry Ledger

designed as an uncomplicated control of finances for home or small business. Add, delete, edit at any time. Compatible with DBM. Only **\$95**

Write or phone for complete software price list.



2457 Wehrle Drive  
Amherst, NY 14221  
716/631-3011

# - COMPUTER SHACK -

Computer Shack has been in the publishing business for 2 years publishing software for the TRS-80 Model I and III. We are now expanding into the COCO. If you would like a major publisher to handle your software send us a copy for evaluation. We have full color packaging, and established dealer network, foreign distributors, and have booths at major computer shows throughout the country, etc. We can sell more copies of your programs than any other distributor. If you are a machine language programmer we have some programs that run on the model I and III that we would like to convert to the COCO. If you are interested in this send us a sample of your programming along with your name and address.

Our new 32 page catalog (Model I, III and COCO) is hot off the press. It contains software, hardware, and misc. If you live in the U.S. write now for your free copy. Due to the high cost of mailing, if you live outside the U.S. please send \$1.00 for your catalog and we will refund this on your first order.

Note our policy of giving a discount for larger orders. We make more money on a big order and we pass the savings along to you. You can save 20% on all your software by buying 4 programs.

## PRINTERS & PRINT BUFFERS

The COCO has a serial print port and to use a printer you must either buy a serial printer (they cost more) or buy a converter. Computer Shack now has a converter that also stores the data in its memory until the printer is ready for it. This is an outstanding feature as most printers are fairly slow.

16K Ser to Par .....	\$239.00
16K Ser to Ser .....	\$259.00
X-TRA 16k memory .....	\$30.00
C. Itoh Prowriter Parallel .....	\$467.00
C. Itoh Prowriter Serial .....	\$579.00
Epson MX 80 Ft Parallel .....	\$529.00
Epson MX 80 FT Serial .....	\$629.00

## COLOR TAPE COPY \$15.95

By Bob Withers

There have been few copy programs on the market for the Color Computer but none can compare with Color Tape Copy. This program is designed so that you don't lose any of your valuable programs or data bases.

It will make a backup of any Color Computer Tape: Machine language, data, or basic program.

First load color tape copy into your CC. Then it prompts you to put your original copy into the recorder. After it loads the program into memory it tells you to put a blank tape into the recorder and press the record button. It then writes the program to a new tape.

You'll never have to worry about your little kids destroying your \$20.00 tapes. 16K

## COLOR DIRECT FILE TRANSFER

Tape Version \$19.95

By Bob Withers

Now a program for the Color Computer that allows you to download basic programs from Bullet-80 systems. It will also send and receive programs from other Color Computers, Model I's and Model III's. Direct File Transfer (DFT) is a modem program which will handle the direct uploading and downloading of machine language, work processors files, text files, and basic programs directly to tape with no conversion necessary. It is the program you must have to download from any Bullet 80 system. DFT also has a chat mode, and has software controlled half and/or full duplex. For modem use only.

## TELEWRITER - 64

Best word processor for the Color Computer.

Tape..... \$49.95 Disk..... \$59.95

## HAYES SMART MODEM

The very finest modem you can buy for the Color Computer or any other computer. Features include auto dial, auto answer, built in speaker LED signals auto redial, etc.

300 Baud..... \$239.00 1200 Baud..... \$569.00

## BUGOUT

A compact but very powerful monitor for the 6809 microprocessor.

Only..... \$19.95

## MADNESS AND THE MINOTAUR

A classic adventure game utilizing two word commands.

Price..... \$19.95

## DRAGONQUEST

A new text adventure by Charles Forsythe. You must rescue the princess from the Smaeagor Monarch of Dragonfolk. All Machine language. Fast, Exciting and only .....

\$15.95

## BOOKS FOR THE COLOR COMPUTER

Programs and Applications for the COCO

Alfred Baker..... \$14.95

TRS-80 Color Basic

Bob Albrecht..... \$9.95

Color Computer Graphics

Ron Clark..... \$9.95

Color Computer Song Book

Ron Clark..... \$7.95

TRS-80 Color Programs

Rugg & Feldman..... \$19.95

## MISADVENTURE SERIES

MADAM ROSA'S MASSAGE PARLOR

Tape..... \$15.00

WET T-SHIRT CONTEST

Tape..... \$15.00

# COMPUTER SHACK

1691 Eason • Pontiac, Michigan 48054

Info: (313) 873-8700 • Orders: CALL TOLL FREE (800) 392-8881

Master Charge and VISA OK. Please add \$3.00 for shipping in the U.S.A. - \$5.00 for Canada or Mexico - Proper postage outside of U.S. - Canada - Mexico.

Dealers: We are distributors for all items in this ad. Write for our catalog and price list.



```

3480 TU(X)=0:NEXT X
3490 GOSUB 3790
3500 Q1=101:Q2=107:Q3=113:Q4=121
3510 FOR X=1 TO 12
3520 FOR Y=1 TO 12
3530 IF E1$(Y)=D2$(X) THEN 3540
ELSE 3560
3540 PRINT@Q1-1,"";:PRINTUSING"$
##.##";E2(Y)+E3(Y)+E4(Y)
3550 TU(X)=TU(X)+E2(Y)+E3(Y)+E4(
Y)
3560 IF G1$(Y)=D2$(X) THEN 3570
ELSE 3590
3570 PRINT@Q2,"";:PRINTUSING"$##
.##";G2(Y)+G3(Y)+G4(Y)
3580 TU(X)=TU(X)+G2(Y)+G3(Y)+G4(
Y)
3590 IF W1$(Y)=D2$(X) THEN 3600
ELSE 3620
3600 PRINT@Q3+1,"";:PRINTUSING"$
##.##";W2(Y)+W4(Y)+W5(Y)
3610 TU(X)=TU(X)+W2(Y)+W4(Y)+W5(
Y)
3620 NEXT Y
3630 Q1=Q1+32:Q2=Q2+32:Q3=Q3+32
3640 NEXT X:Q4=120
3650 FOR X=1 TO 12
3660 IF TU(X)<1 THEN 3680
3670 PRINT@Q4+1,"";:PRINTUSING"$
###.##";TU(X);
3680 Q4=Q4+32:NEXT X:GOSUB 3780:
CLS:TB=0
3690 FOR X=1 TO 12
3700 TB=TB+TU(X):NEXT X
3710 CLS:PRINT:PRINTTAB(5)"YEARL
Y UTILITY SUMMARY"
3720 PRINT:PRINT:PRINTTAB(2)"TOT
AL UTILITY COST="";:PRINTUSING"$#
###.##";TB
3730 GOSUB 3780:GOTO 1200
3740 PRINT" MON CHARGE TA
X TOTAL"
3750 PRINT D7$;:RETURN
3760 PRINT@450,"ENTER ONE OF THE
ABOVE";:RETURN
3770 '
3780 PRINT@482,"PRESS <ENTER> TO
CONTINUE";:INPUT Q:RETURN
3790 D=97:FOR S=1 TO 12
3800 PRINT@D-1,D2$(S):D=D+32:NEX
T S:RETURN
3810 RETURN
3820 FOR X=1 TO 10:CLS
3830 FOR T=1 TO 50:NEXT T
3840 PRINT@233,"ILLEGAL ENTRY":S
OUND 100,1
3850 FOR Y=1 TO 50:NEXT Y,X:CLS:
RETURN
3860 RETURN

```

```

3870 PRINT:PRINT:PRINTTAB(6)"1.S
UMMARIZE CHARGES"
3880 PRINT:PRINTTAB(6)"2.SUMMARI
ZE USAGE"
3890 PRINT:PRINTTAB(6)"3.YEAR-TO
-DATE SUM"
3900 PRINT:PRINTTAB(6)"4.RETURN
TO MAIN LIST"
3910 RETURN
3920 FOR X=1 TO 12
3930 IF E1$(X)=D2$(X) THEN RETUR
N
3940 IF G1$(X)=D2$(X) THEN RETUR
N
3950 IF W1$(X)=D2$(X) THEN RETUR
N
3960 NEXT X:Y1=1:GOSUB 3820:RETR
URN
3970 DATA JAN,FEB,MAR,APR,MAY,JU
N,JUL,AUG,SEP,OCT,NOV,DEC
3980 '
3990 '
4000 ' LOAD DATA FROM CASSET
TE
4010 '
4020 '
4030 CLS:PRINT C7$;:IF ZQ=1 THEN
4500
4040 PRINTTAB(11)"LOAD DATA":PRI
NT C7$
4050 PRINT:PRINTTAB(7)"1. LOAD D
ATA TAPE"
4060 PRINT:PRINTTAB(7)"2. PRESS
PLAY ONLY"
4070 PRINT:PRINTTAB(7)"3. PRESS
ENTER"
4080 LINE INPUT ZZ$
4090 CLS:PRINT:PRINT:PRINT:PRINT
C7$;
4100 PRINTTAB(6)"YOU ARE LOADING
DATA":PRINT C7$
4110 OPEN"I",-1,"NEW"
4120 INPUT#-1,E9,G9,W9
4130 FOR X=1 TO 12
4140 INPUT#-1,E1$(X),E2(X),E3(X)
,E4(X),E5(X),E6(X)
4150 INPUT#-1,G1$(X),G2(X),G3(X)
,G4(X),G5(X),G6(X)
4160 INPUT#-1,W1$(X),W1(X),W2(X)
,W4(X),W5(X),W6(X)
4170 NEXT X
4180 CLOSE#-1
4190 ZQ=1
4200 GOTO 1200
4210 N3=N3+N1
4220 N4=N4+N2
4230 '
4240 '
4250 ' SAVE DATA TO CASSETTE

```

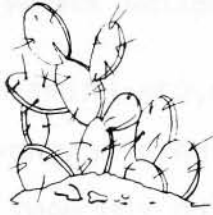

# PRICKLY-PEAR SOFTWARE

## QUALITY PROGRAMS FOR YOUR COCO & TDP-100

PROGRAMS REQUIRE 16K EXTENDED BASIC FOR TAPE, AND 32K DISK UNLESS OTHERWISE NOTED.

### Flight

If you'd like to fly a plane then this is what you've been waiting for. A really good graphics oriented flight simulator in high resolution. Four difficulty levels let you go from student level to a difficult instrument-only landing. In front of you on the screen are your instruments, and above them are two representations of your plane in relation to the flight path (top and side views). At the higher levels all you have to go by are the instruments. Can you put it down on the runway to hear the synthesized voice from the tower say "perfect landing"? It's tough! You use your joystick just like the control stick on a plane, and the action is realistic indeed. This program was written by a professional flyer — a pilot for a major United States air carrier, and the high standards of professionalism really show. Just CLOADM and take to the skies!! Requires 32K extended. **TAPE is \$19.95 — DISK is \$24.95**

### Las Vegas Weekend

Two great high-resolution games. You will really feel you've had a vacation. First, play a round of golf. It all happens in high resolution. Choose your club, decide how to swing, and go for it, but watch out for the sand traps and water hazards! This course would challenge the pros. When you get on the green, the scene zooms in for a closeup view while you putt.

After your shower, go down to the casino and play some poker against the computer. High-resolution graphics plays just like the draw poker machines in Vegas. Win big... maybe. Both great games are included in the Las Vegas Weekend, on separate tapes or one disk. **\$24.95 tape — \$29.95 disk**

### The Fantasy Master's Secretary

This program will be greatly appreciated by the many people trying to run a fantasy game! It's not easy to keep track of hit points, charges in magic items, monsters, game time, armor values, and a lot more, all while trying to conduct a meelee and listen to 8 people talking at once. If you ever thought you needed a secretary, this is it! It keeps track of all the above and more, and even has a help file in case you forget how to use it. It also figures the experience points of monsters while keeping an electronic eye on value and weight of treasure found. You'll truly wonder how you got along without it!!! If you quit before the campaign is completed, you can save the whole thing to tape (or disk) and take up right where you left off next time you play. At the beginning it will ask you whether or not the players can see the screen, and set its displays up accordingly. Remember, this isn't a game — it's an aid to use with a fantasy game. **\$19.95 tape — \$24.95 disk.**

### Eight-bit Bartender:

This will light up your next party! Over 100 great drink recipes are stored by the bartender and called up at your command. Ask for them by drink name, main liquor used, or class of drink (highball, cocktail, etc.). These were gathered from the favorites and house specialties at famous pubs and taverns across the US. It outputs to the screen, printer, or both! At your next party let the guests browse through the Bartender. Needs 32K. **TAPE \$19.95 — DISK \$24.95**

### Phonics I

This classroom-tested program is the newest in our Phonics series. Written by the same elementary school teacher, it takes up where PREREAD I, II, & III leave off. Actually two programs (on separate tapes), the TUTORIAL teaches all 22 of the consonant blends using on-screen graphics and voice (controlled by the computer and played through the TV speaker). The TEST program asks for the letters in these blends (again using voice through the speaker), and checks the keyboard input for the correct answer. Again, on screen graphics are used as an aid to learning, and immediate feedback to the learner is given.

### Phonics II

Similar to **Phonics I** in concept and execution, but **Phonics II** teaches consonant digraphs. Again there are two programs (on different tapes) for the TUTORIAL and TEST modes.

Both **Phonics I** and **Phonics II** are well documented, and are sold separately on **TAPES** for **\$24.95** each. They are also available as a package — only on **DISK** for **\$44.95**.

### A Partial List of Prickly-Pear Programs

Astrology, Gangbusters, Household Helper, Fantasy Gamer's Package, Viking, Football, Preread I, II & III, Mathpac I, Tarot, I Ching, Numerology, The Great Word Game, The 80C Songbook, Phonics I, Phonics 2, Flight, Las Vegas Weekend, The 8-Bit Bartender, The Fantasy Master's Secretary, Monsters & Magic, Topsy Turvy, Galactic Patrol, Blockade, Sea Wars, Jungle, Spanish . . .



ALL Programs in this ad, including disk versions, carry the Rainbow certification seal!

SEND A STAMPED, SELF-ADDRESSED LONG ENVELOPE FOR COMPLETE CATALOGUE

Your Personal check is welcome - no delay. Include \$1.50 shipping for each program ordered. (Shipping free on \$50.00 or larger orders). Az. residents add 6% sales tax. Orders shipped within two days.

Stocked by Quality Dealers, or

Send Order To: **PRICKLY-PEAR SOFTWARE**  
9822 E. Stella Road  
Tucson, Arizona 85730  
(602) 886-1505

```

4260 '
4270 '
4280 CLS:PRINT C7$;
4290 PRINTTAB(11)"SAVE DATA":PRINT C7$
4300 PRINT:PRINTTAB(7)"1. LOAD DATA TAPE"
4310 PRINT:PRINTTAB(7)"2. PRESS RECORD & PLAY"
4320 PRINT:PRINTTAB(7)"3. PRESS ENTER"
4330 LINE INPUT ZZ$
4340 CLS:PRINT:PRINT:PRINT:PRINT C7$;
4350 PRINTTAB(6)"YOU ARE SAVING DATA":PRINT C7$
4360 OPEN"O",-1,"NEW"
4370 PRINT#-1,E9,G9,W9
4380 FOR X=1 TO 12
4390 PRINT#-1,E1$(X),E2(X),E3(X),E4(X),E5(X),E6(X)
4400 PRINT#-1,G1$(X),G2(X),G3(X),G4(X),G5(X),G6(X)
4410 PRINT#-1,W1$(X),W1(X),W2(X),W4(X),W5(X),W6(X)
4420 NEXTX
4430 CLOSE#-1
4440 GOTO1200
4450 '

```

```

4460 '
4470 ' DATA RELOAD ERROR
4480 '
4490 '
4500 CLS:PRINT@64,C7$:PRINT:PRINT
4510 PRINTTAB(6)"DATA ALREADY LOADED":PRINT
4520 PRINTTAB(2)"DO YOU WANT TO RELOAD? (Y/N)";
4530 FORII=1TO10:SOUND100,3:NEXT
4540 LINE INPUT KK$
4550 IF KK$="Y" THEN 4030 ELSE 1200
4560 '
4570 '
4580 ' INPUT PRINT ROUTINE
4590 '
4600 '
4610 PRINT"STATE SALES TAX"
4620 PRINT"PRESENT METER READ"
4630 PRINT"PREVIOUS METER READ"
4640 PRINT:PRINT:PRINTTAB(10)"MAKE ENTRIES"
4650 PRINT@118,"";:RETURN
4660 CLS:PRINTTAB(6)"YEAR-TO-DATE SUMMARY":RETURN
4670 '
4680 '
4690 ' PRINTER ROUTINE
4700 '
4710 '
4720 CLS:PRINT:PRINT C7$;
4730 PRINTTAB(12)"PRINTING":PRINT C7$
4740 C9$="ELECTRIC":C8=9:GOSUB 5840
4750 PRINT#-2,TAB(14)"METER READINGS";TAB(31)"ELECTRIC";TAB(41)"ELECTRIC";
4760 PRINT#-2,TAB(53)"FUEL";TAB(63)"STATE";TAB(71)"ELECTRIC"
4770 PRINT#-2,TAB(3)"MONTH";TAB(12)"PRESENT";TAB(21)"PREVIOUS";TAB(32)"USAGE";
4780 PRINT#-2,TAB(42)"CHARGE";TAB(52)"ADJUST";TAB(64)"TAX";TAB(72)"TOTAL"
4790 PRINT#-2,C6$
4800 T1=0:T2=0:T3=0:T4=0
4810 FOR X=1 TO E9
4820 T1=T1+E5(X)-E6(X):T2=T2+E2(X)
4830 T3=T3+E3(X):T4=T4+E4(X)
4840 IF E1$(X)="" THEN 4930
4850 PRINT#-2,TAB(4);E1$(X);TAB(12)"";
4860 PRINT#-2,USING"#####";E5(X);:PRINT#-2,TAB(22)"";
4870 PRINT#-2,USING"#####";E6(X)

```

### COLOR-FORTH

Including SEMIGRAPHIC-8 EDITOR  
+ UTILITIES

- Disk and Tape utilities
- Boot from disk or tape
- Graphics and Sound commands
- Printer commands
- Auto-repeat and Control keys
- Fast task multiplexing
- Unique TRACE function in kernal
- Clean INTERRUPT handling in HIGH-LEVEL FORTH
- CPU CARRY FLAG accessible
- Game of LIFE demo
- ULTRA FAST:written in assembler
- Directions included for installing optional ROM in disk controller or cartridge
- Free Basic game "RATMAZE"



\$58.95

# FORTH

HOYT STEARNS ELECTRONICS  
4131 E. CANNON DR. PHOENIX, ARIZONA 85028  
602-996-1717





# SOFT CITY

- Your finest single source for TRS-80®COLOR COMPUTER / TDP SYSTEM 100 compatible software.
- We offer one of the largest and most comprehensive selections of software available anywhere. These major programs have been developed by some of the leading software houses, and are sold at fully competitive prices. Save yourself time and trouble!
- Our latest catalog offers word processing, terminal packages, educational software, and a full selection of utilities for both disk and tape. Many superb games - adventure, arcade, and board style are also available, demonstrating the powerful Hi-Resolution capabilities of the Color Computer. We also carry a number of peripherals and supplies for your system.
- Our catalog is yours free for the asking!

---

■ We are dealers for:

- |  |  |
|--|--|
| <input type="checkbox"/> COGNITEC            | <input type="checkbox"/> COMPULINK             |
| <input type="checkbox"/> COMPUTERWARE        | <input type="checkbox"/> CORNSOFT              |
| <input type="checkbox"/> EIGEN SYSTEMS       | <input type="checkbox"/> FRANK HOGG LABORATORY |
| <input type="checkbox"/> MARK DATA PRODUCTS  | <input type="checkbox"/> PRICKLY PEAR SOFTWARE |
| <input type="checkbox"/> SKYLINE SOFTWARE    | <input type="checkbox"/> SOFTCORE SOFTWARE     |
| <input type="checkbox"/> SPECTRAL ASSOCIATES | <input type="checkbox"/> SPEECH SYSTEMS        |
| <input type="checkbox"/> SUGAR SOFTWARE      | <input type="checkbox"/> TDP ELECTRONICS       |
| <input type="checkbox"/> TOM MIX             | <input type="checkbox"/> U.S.ROBOTICS          |
| <input type="checkbox"/> VERBATIM            | <input type="checkbox"/> YORK                  |
| <input type="checkbox"/> ETC., ETC....       |  |

---

## ORDERING INFORMATION

---

**ALL ITEMS SHIPPED FROM STOCK  
MASTERCHARGE AND VISA WELCOME**

**10% discount on orders over \$50.00!**

Phone orders may be placed at:  
**(312) 260-0929 (Our voice line),**

or, if you have a modem, you may order through our  
**METROWEST BBS at:**

**(312) 260-0640**

Mail orders and requests for catalogs should be sent to:

**SOFT CITY**

**442 Sunnyside  
Wheaton, IL 60187**



```

);:PRINT#-2,TAB(33)"";
4880 PRINT#-2,USING"####";E5(X)-
E6(X);:PRINT#-2,TAB(41)"";
4890 PRINT#-2,USING"#####.##";E2(
X);:PRINT#-2,TAB(52)"";
4900 PRINT#-2,USING"#####.##";E3(X
);:PRINT#-2,TAB(62)"";
4910 PRINT#-2,USING"#####.##";E4(X
);:PRINT#-2,TAB(71)"";
4920 PRINT#-2,USING"#####.##";E2(
X)+E3(X)+E4(X)
4930 NEXT X:PRINT#-2,C6$
4940 PRINT#-2,TAB(3)"TOTALS";TAB
(33)"";
4950 PRINT#-2,USING"####";T1;:PR
INT#-2,TAB(41)"";
4960 PRINT#-2,USING"#####.##";T2;
:PRINT#-2,TAB(51)"";
4970 PRINT#-2,USING"#####.##";T3;
:PRINT#-2,TAB(62)"";
4980 PRINT#-2,USING"#####.##";T4;:
PRINT#-2,TAB(71)"";
4990 PRINT#-2,USING"#####.##";T2+
T3+T4
5000 PRINT#-2,C4$
5010 C9$="GAS":C8=11:GOSUB 5840
5020 PRINT#-2,TAB(14)"METER READ
INGS";TAB(33)"GAS";TAB(43)"GAS";
5030 PRINT#-2,TAB(53)"GAS";TAB(6
3)"STATE";TAB(73)"GAS"
5040 PRINT#-2,TAB(3)"MONTH";TAB(
12)"PRESENT";TAB(21)"PREVIOUS";T
AB(32)"USEAGE";
5050 PRINT#-2,TAB(41)"SERVICE";T
AB(53)"COST";TAB(64)"TAX";TAB(72
)"TOTAL"
5060 PRINT#-2,C6$
5070 T1=0:T2=0:T3=0:T4=0
5080 FOR X=1 TO 69
5090 T1=T1+G5(X)-G6(X):T2=T2+G2(
X)
5100 T3=T3+G3(X):T4=T4+G4(X)
5110 IF G1$(X)="" THEN 5200
5120 PRINT#-2,TAB(4);G1$(X);TAB(
12)"";
5130 PRINT#-2,USING"#####";G5(X
);:PRINT#-2,TAB(22)"";
5140 PRINT#-2,USING"#####";G6(X
);:PRINT#-2,TAB(33)"";
5150 PRINT#-2,USING"#####";G5(X)-
G6(X);:PRINT#-2,TAB(41)"";
5160 PRINT#-2,USING"#####.##";G2(
X);:PRINT#-2,TAB(52)"";
5170 PRINT#-2,USING"#####.##";G3(X
);:PRINT#-2,TAB(61)"";
5180 PRINT#-2,USING"#####.##";G4(
X);:PRINT#-2,TAB(71)"";
5190 PRINT#-2,USING"#####.##";G2(
X)+G3(X)+G4(X)

```

```

5200 NEXT X:PRINT#-2,C6$
5210 PRINT#-2,TAB(3)"TOTALS";TAB
(33)"";
5220 PRINT#-2,USING"####";T1;:PR
INT#-2,TAB(41)"";
5230 PRINT#-2,USING"#####.##";T2;
:PRINT#-2,TAB(51)"";
5240 PRINT#-2,USING"#####.##";T3;
:PRINT#-2,TAB(62)"";
5250 PRINT#-2,USING"#####.##";T4;:
PRINT#-2,TAB(71)"";
5260 PRINT#-2,USING"#####.##";T2+
T3+T4
5270 PRINT#-2,C4$
5280 C9$="WATER":C8=11:GOSUB 584
0
5290 PRINT#-2,TAB(14)"METER READ
INGS";TAB(32)"WATER";TAB(42)"WAT
ER";
5300 PRINT#-2,TAB(52)"SEWER";TAB
(63)"STATE";TAB(71)"UTILITY"
5310 PRINT#-2,TAB(3)"MONTH";TAB(
12)"PRESENT";TAB(21)"PREVIOUS";T
AB(32)"USEAGE";
5320 PRINT#-2,TAB(42)"CHARGE";TA
B(52)"CHARGE";TAB(64)"TAX";TAB(7
2)"TOTAL"
5330 PRINT#-2,C6$
5340 T1=0:T2=0:T3=0:T4=0
5350 FOR X=1 TO W9
5360 T1=T1+W6(X)-W1(X):T2=T2+W2(
X)
5370 T3=T3+W4(X):T4=T4+W5(X)
5380 IF W1$(X)="" THEN 5470
5390 PRINT#-2,TAB(4);W1$(X);TAB(
12)"";
5400 PRINT#-2,USING"#####";W6(X
);:PRINT#-2,TAB(22)"";
5410 PRINT#-2,USING"#####";W1(X
);:PRINT#-2,TAB(33)"";
5420 PRINT#-2,USING"#####";W6(X)-
W1(X);:PRINT#-2,TAB(41)"";
5430 PRINT#-2,USING"#####.##";W2(
X);:PRINT#-2,TAB(52)"";
5440 PRINT#-2,USING"#####.##";W4(X
);:PRINT#-2,TAB(62)"";
5450 PRINT#-2,USING"#####.##";W5(X
);:PRINT#-2,TAB(71)"";
5460 PRINT#-2,USING"#####.##";W2(
X)+W5(X)+W4(X)
5470 NEXT X:PRINT#-2,C6$
5480 PRINT#-2,TAB(3)"TOTALS";TAB
(33)"";
5490 PRINT#-2,USING"####";T1;:PR
INT#-2,TAB(41)"";
5500 PRINT#-2,USING"#####.##";T2;
:PRINT#-2,TAB(51)"";
5510 PRINT#-2,USING"#####.##";T3;
:PRINT#-2,TAB(62)"";

```

# CoCo Warehouse

## NOW THE BEST IS EVEN BETTER! MASTER CONTROL II from Soft Sector Marketing

The best doesn't always cost more and MASTER CONTROL is a good example. What would you be willing to pay for a program that would cut your typing time by more than 50% and eliminate hours of debugging because you misspelled a command word? For example the command STRING\$ (requires nine strokes, with MASTER CONTROL II you only require two strokes. Just hit the down arrow key twice and it's done, and no mistakes. That is just one of the 50 pre-programmed commands available to you. If that isn't enough you also have the ability to customize your own key to enter a statement or command, correctly, automatically every time. But that's not all, how about automatic line numbering. Just enter the starting number and the increment you want and MASTER CONTROL II will do it for you. You also have direct control of MOTOR, AUDIO and TRACE plus a direct RUN key. Sounds great? Well thousands of color computer owners have been enjoying these features for years. But now the new MASTER CONTROL II also has the following features:

- \* New plastic overlay that can be removed when you are not using MASTER CONTROL II.
- \* New documentation, to help you get the most from the program.
- \* New repeating keyboard.
- \* New-now loads to disk with appropriate disk commands.

Now for the best part! MASTER CONTROL II sells for the low, low price of just \$24.95 but as an introductory offer it's yours for only...

**\$18<sup>95</sup>**

Plus \$2.50 Shipping & Handling

SAVE A BUCK...Order the NANOS Color Basic and Extend pocket card with your MASTER CONTROL II and you get this \$4.95 value for only \$3.95 extra. (NANOS pocket card not sold separately.)

166  
PAGES

only  
**\$14.95**  
plus \$2.50  
shipping



A MUST BOOK  
for the  
Color  
computer  
owner!  
\*  
Schematics  
\*  
Spec  
Sheets

### ORDER YOUR COPY TODAY!

The first document to provide information that will allow the user to take advantage of all the features of the Color Computer. Aimed at the machine language user.

The FACTS attempts to explain, and describes in detail, how the user can make use of the computers internal features. Divided into two sections: Hardware and software; the primary emphasis is on hardware capabilities and circuits. Provides detailed explanations of all the internal large scale integrated circuits.

## MARCH SPECIALS DONKEY KING by Tom Mix Software

Exciting sound-Realistic graphics. Never before have you seen a game like this for your CoCo. Four graphic screens just like the actual arcade games.

Requires 32K  
TAPE...\$19.95      DISK...\$22.95

IF YOU DON'T HAVE 32K ORDER THE RAM SLAM. THIS SIMPLE KIT TO UPGRADE YOUR COCO TAKES LESS THAN 30 MINUTES TO INSTALL. NO SOLDERING REQUIRED...  
only \$49.95

----- Super Saver -----

## COLOR BONANZA 50 Programs - 6 Cassettes Some 4K \* Some 16K \* Some 32K Games - Educational - Utilities FUN FOR THE WHOLE FAMILY Reg. \$49.95..... only \$41.88 Plus \$2.50 Shipping

## COLORPEDE by Intracolor

An arcade quality game with fast action to challenge the most avid arcade buff. The high contrast characters on a black screen add to the visual excitement as the Colorpede slithers through the toad stools. It's up to you to try and destroy the Colorpede, knock out the menacing bouncing bug and eliminate toad stools. As the action intensifies the Colorpede moves faster and faster, the beetle plants more toad stools and the stinger poisons them. A new game from the company that is setting the standards for excitement.

Cassette...\$25.46      Disk...\$29.71

## DOODLE BUG by Computerware

You must hustle your lady bug through an intricate maze of barriers and turnstiles, while trying to earn points by eating all the dots, letters and hearts. Enemy bugs buzz after you and you must avoid the skulls! Exquisite sound adds to the excitement. A must game for anyone who enjoys fun and a challenge.

Cassette...\$21.21      Disk...\$25.46

WRITE FOR OUR CATALOG  
SEND ORDERS TO

500 N. Dobson • Westland, MI 48185  
Phone (313) 722-7957

HOW TO ORDER BY MAIL: For prompt and courteous shipment, SEND MONEY ORDER, CERTIFIED CHECK, CASHIERS CHECK, MASTERCARD/VISA (include card number, inter-bank No., expiration date and signature) PERSONAL AND BUSINESS CHECKS MUST CLEAR OUR BANK BEFORE PROCESSING. Shipping and packaging charge of \$2.50 minimum must be added to all orders in continental U.S. (Canadian order \$5.00 minimum) Michigan residents include 4% sales tax 10% deposit required on C.O.D. orders.

NEW NEW NEW NEW NEW NEW NEW NEW NEW

## COLOR GRAPHIC EDITOR by Larry Ashmun

At last, a true Graphic Drawing program that permits the creation of graphic pictures on the screen storing them in one of four locations. Recalling them as needed for review.

The pictures can be saved to disk, to be loaded into the Micro Works disk editor. The graphics are saved in Assembler format, but details are provided for using the information in a BASIC program. Works with cassette or disk systems.

List price \$19.95  
Introductory price **\$17<sup>88</sup>**

## TIMS Top Information Management System by Sugar Software

An outstanding easy to use personal database management system with these features:

- \* Keeps files of programs, mail lists, rosters, collections or anything
- \* Variable record and field length
- \* Phrase substitution editor
- \* Up to 8 user-definable fields
- \* ML sort (up to 3 fields), search and delete functions
- \* Two search modes-range and item
- \* User definable printer format, for any printer

Includes full documentation and programmer's guide. Requires 16K Extended Basic. 32K recommended.

Cassette only...\$24.95

## COPY CAT by Ron Wright

Copy Cat is a general purpose utility program for the color computer, with 16K or 32K of RAM memory. The program will aid the user in making back-up copies of taped based software.

Cassette only...\$19.95

## TYPING TUTOR by Spectral Associates

This personal typing teacher allows you to learn at your own pace whether a beginner or just a little rusty. 16K

Cassette...\$19.95

## MATH DRILL by Tom Mix Software

A program to help children practice addition, subtraction, multiplication and division skills. A "Smiley Face" is used for motivation and reward. Skill level automatically adjusts to child's ability. 16K Ext Basic

Cassette...\$19.95



```

5520 PRINT#-2,USING"###.##";T4;:
PRINT#-2,TAB(71)"";
5530 PRINT#-2,USING"####.##";T2+
T3+T4
5540 C9$="UTILITY":C8=10:GOSUB 5
840:T4=0
5550 PRINT#-2,TAB(19)"ELECTRIC";
TAB(37)"GAS";TAB(51)"WATER";
5560 PRINT#-2,TAB(65)"UTILITY"
5570 PRINT#-2,TAB(6)"MONTH";TAB(
20)"TOTAL";TAB(36)"TOTAL";TAB(51
)"TOTAL";
5580 PRINT#-2,TAB(66)"TOTAL":PRI
NT#-2,C6$
5590 FOR X=1 TO 12
5600 PRINT#-2,TAB(7)D2$(X);
5610 T1=E2(X)+E3(X)+E4(X)
5620 T2=G2(X)+G3(X)+G4(X)
5630 T3=W2(X)+W4(X)+W5(X)
5640 PRINT#-2,TAB(19)"";:PRINT#-
2,USING"####.##";T1;
5650 PRINT#-2,TAB(34)"";:PRINT#-
2,USING"####.##";T2;
5660 PRINT#-2,TAB(50)"";:PRINT#-
2,USING"####.##";T3;
5670 T4=T4+T1+T2+T3
5680 PRINT#-2,TAB(64)"";:PRINT#-
2,USING"####.##";T1+T2+T3
5690 NEXT X

```

```

5700 PRINT#-2,C6$
5710 PRINT#-2,TAB(6)"TOTALS";TAB
(64)"";:PRINT#-2,USING"#####.##"
;T4
5720 GOTO 1200
5730 '
5740 '
5750 '      MANUAL PROGRAM STOP
5760 '
5770 '
5780 CLS:STOP:CLS:GOTO 1200
5790 '
5800 '
5810 '      PRINTER ROUTINE
5820 '
5830 '
5840 PRINT#-2,C3$;C4$;C5$;C1$
5850 PRINT#-2,TAB(C8)C9$+" BILL
SUMMARY"
5860 PRINT#-2,C1$;C5$;C2$
5870 PRINT#-2,C1$;C1$
5880 RETURN

```



---

Find The  
**COLOR COMPUTER INFORMATION**  
**YOU NEED**  
**COLOR COMPUTER INDEX**   
**COLOR COMPUTER CATALOG** 

American Library and Information Services  
 Dept. R, 3705 Mary Ellen NE, Albuquerque, NM 87111

Gentlemen:

- Yes! Send me **COLOR COMPUTER INDEX 1980-1981** at \$5 (Canada and Mexico \$6)
- Yes! Sign me up for **COLOR COMPUTER INDEX 1982** (4 issues) for \$16 (Canada and Mexico \$20)
- Yes! Sign me up for **COLOR COMPUTER CATALOG 1982** (two issues) for \$20 (Canada and Mexico \$24)
- YES!** Sign me up for **Color Computer Index 1983** (Six issues for \$24—Canada & Mexico \$30)
- YES!** Sign me up for **Color Computer Index 1983** (Two issues for \$20—Canada & Mexico \$24)

Single Issues:

**Color Computer Index** \$6 U.S. (Except 1980-1981)  
**Color Computer Catalog** \$12 U.S.

Name \_\_\_\_\_  
 Address \_\_\_\_\_  
 City \_\_\_\_\_ State \_\_\_\_\_ Zip \_\_\_\_\_

## Starship Hercules: Well Documented, Sophisticated Fun

Although I am not an avid game player, my son Philip (age 10) and I enjoyed this space game, *Starship Hercules*—a refreshing change from the Pac-Man and Space Assault type of games which are so popular. The lower skill levels allowed us to learn the basics of the game; the more advanced levels offered us a real challenge and a chance to develop playing strategies. While learning, we needed to refer frequently to the detailed instruction booklet (27 pages). It always provided the desired information. The following paragraphs describe the game and its documentation.

The game is written in BASIC and requires 21K of RAM (hence a 32K Color Computer). Most of the game is played viewing a screen that shows both an area map (quadrant—explained below) around the Starship Hercules and important data. The quadrant map displays the Hercules and any stars, starbases, or Zargons in that quadrant. The symbols are not generated using any of the graphics modes—they are produced using the various ASCII codes above &H7F.

As captain of the Starship Hercules, I am commissioned to seek out and destroy the invading Zargon spaceships. I have limited amounts of energy, weapons, and time to do this. These enemy ships are hiding in an 8 quadrant by 8 quadrant matrix (the Buffer Zone), which I can search, one quadrant at a time.

To aid me, I have the Hercules' shipboard computer, which performs several functions:

1. It gives me navigation data to the Starbases (space stations) where I can get refueled and additional weapons. Any damaged Hercules systems can also be repaired at these Starbases.
2. It shows me what I have found in already-explored quadrants, and which quadrants I have yet to explore.
3. It calculates navigational data (speed and direction) from my present location to any other quadrant.
4. It gives me a status report—energy and time remaining, Zargons remaining, and the status of all Hercules systems.

Once I find one (or more) Zargons, the Hercules computer calculates the firing angles for my photon torpedoes (if neither the computer nor my weapons systems have been damaged in a recent battle).

Each time I play the game, I am offered a choice of difficulty levels. At the more difficult levels, the Zargons move from quadrant to quadrant, they have more energy (which means they're harder to destroy), and they use a special weapon to reduce my defenses. In addition, the Hercules systems (navigation, computer, weapons, and defense) break down more frequently and take longer to repair. While these systems are damaged, I must rely on my own memory and resourcefulness to outwit the Zargons.

The number of Zargon ships (and their locations, of course) vary in each game, as does the number and location of the Starbases for refueling, rearming, and repairing the Hercules. And the Stardates (time allowed to destroy the Zargon fleet) differ in each game.

Particularly important for a game as complicated as *Starship Hercules* are the instructions. In this case, the 27-page booklet details every aspect of the game. Philip (my 10 year old son) lacked the patience to read them—this game is

apparently intended for older (and more patient) readers of teen age or older. The only deficiency I noted was the rather poor quality of the illustrations (made with a printer, using symbols different from those in the game) and their placement all together at the end of the booklet; it would have been less confusing to place each diagram near the text it illustrated.

In summary, Philip and I both enjoyed this game. The few points about which I was still confused after reading the complete instructions were quickly cleared up when we began to play. I definitely consider *Starship Hercules* worth the retail price.

(Aardvark, 2352 S. Commerce, Walled Lake, MI 48088, \$19.95 on tape)

—Jerry Oefelein

## Galactic Hangman Can Get You Hooked

Looking for a fun game? One that takes some thinking, is educational, and the whole family can enjoy? Sugar Software has come up with a fun, space-age version of the popular game of Hangman. The program *Galactic Hangman* comes with both a 16K and 32K version on the same tape. Both versions have Sugar's auto-load feature built in, which makes the tape easy to load quickly. The idea of a 16K and 32K version on the same tape is ideal for those of you who have 16K now but plan to upgrade sometime in the future.

**BATTLE of GETTYSBURG**  
**A Strategy Game**  
**for mature Players**

---

**STOP REBEL INVADERS**  
**OR DIE!**

---

16K ext. joystick

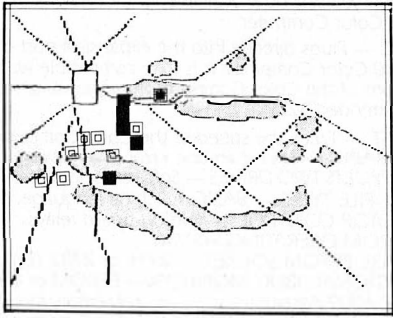

\$20.95 cassette

---

**SOFTWRIDE**  
P.O. Box 3504  
Austin, Texas: 78764  
(512)-444-6135

First, let's talk about the 16K version. After loading, the computer instructs you to choose one of 14 different files of 50 words each that are part of the program. You are then instructed to choose between a word from the computer's memory and one of your own. All the letters of the alphabet appear at the top of the screen and change color as they are chosen. I won't discuss the graphics except to say that they are good, fun, and entertaining. Provision is made in the 16K version for creating and storing as many 50 word files as you wish to recall later on.

Except for the file recall feature, the 32K version has all the features of the 16K version, plus many others. The graphics are more "galactic" and the computer chooses randomly from 700 everyday words that are stored in the memory. The words appear to be well chosen and of average difficulty. This is the problem with many hangman-type games—the words are either too simple or too uncommon. Also, with the 32K version, if you load the tape and take no more action, the computer automatically begins choosing words and playing against itself giving a complete demonstration of how the game is played.

One feature which could be added to make the game more exciting would be the addition of a time clock. An additional letter would have to be chosen, say within 20 seconds or you have to move up one more step to the hangman's noose.

The documentation is good, both in the instruction booklet and on the tape. *Galactic Hangman* is recommended for, among others, those looking for a game that you can play with your grandparents and convince them that buying you that expensive CoCo was a wise thing to do.

(Sugar Software, 2153 Leah Lane, Reynoldsburg, OH 43068, \$14.95)

—Tom Johnson

Software Review...

## Match-It Works Well With Young Learners

By Brian James

*Match-It* is an educational program from Micro School Programs (Bertamax Inc.) to help children learn to recognize which upper and lower case alphabet letters belong to each other. Suggested for youngsters from age four to six, *Match-It* comes in both cassette and disk media for the 32K computer. Although the disk version was used for this review, it appears the cassette version is exactly the same.

In *Match-It*, a letter appears on the left side of the screen while letters of the opposite case appear, one at a time, on the right side of the screen. When the correct letter match finally appears on the right, the user presses the space bar to indicate a match. The computer will indicate a correct answer with a happy face and an incorrect match with a sad face. Sound is also used in conjunction with the happy/sad faces. After all 26 letters have been given and matched, a record of how many tries it took to match each letter should appear on the screen along with a "goodbye" to the user. I say "should" because in reality the screen only indicates with a "1+" which letters had one or more misses. This was the only major discrepancy I could find in an otherwise excellent documentation booklet that comes with the program.

Before the program begins in earnest, the user (or parent or teacher) is prompted to decide on a number of options. These include whether upper or lower case letters will appear on the left side of the screen, in what order the letters are to appear (alphabetical or random) and at what speed are the letters on the right side to alternate. The user may also try an example problem before beginning the 26 letter sequence. The documentation suggests that an adult should explain the object of the program to the user, and help select order, level and speed of the program. This is a very wise suggestion considering the age level of the children using the program.

How well does it work? I tested it with my seven year old daughter and although she is one year older than the suggested age level, she liked the program very much. The greatest appeal seemed to be the nicely done graphics and the immediate feedback the program gives you through sound and color. She had a little problem reading some of the characters (made with lower resolution blocks) and a big problem trying to do the program at the highest speed. I found the highest speed hard also. The space bar didn't quite respond as fast as the program wanted it to.

In summary, *Match-It* is a good teaching program to help children learn to recognize upper and lower case letters. Even though the program is written in BASIC, it uses a very nice upper and lower case character set to print instructions and prompts. The age levels suggested (four through six) are perfect for the activity presented. I have heard that Micro School Programs is converting most of their educational programs for use on the 80C. This program illustrates the appealing quality color graphics and sound have in the educational area and how well suited the Color Computer is as a learning tool for children. Parents and educators would do well to write the company for a list of their 80C programs.

(Micro School Programs-Bertamax Inc., 101 Nickerson St., Suite 202, Seattle, WA 98109, \$34.80 disk, \$29.90 tape, 32K)

—Brian James



**POOR MAN'S FLOPPY**  
**HIGH SPEED CASSETTE SYSTEM**

**Now for the TRS-80 Color Computer**

The JPC PRODUCTS High Speed Cassette System, in operation for over 4 years, is now available for all versions of the Radio Shack<sup>®</sup> Color Computer.

- TC-8C — Plugs directly into the expansion port of your TRS-80 Color Computer. It is fully compatible with all versions of the Color Computer from the standard 4K to the Extended 32K.
  - FAST — Twice the speed of the Color Computer System.
  - RELIABLE — Less than one error in a million bits.
  - SUPPORTS TWO DRIVES — Software selectable.
  - ALL FILE TYPES — BASIC, machine language, data.
  - MOTOR CONTROL — Two on-board relays.
  - EPROM OPERATING SYSTEM
  - SPARE EPROM SOCKET — 2716 or 2732 compatible.
  - OPTIONAL JBUG MONITOR — EPROM or Cassette
    - 6809 Assembler                     • Memory modify and list
    - 6809 Dis-assembler               • Break point traps
  - ASSEMBLED and TESTED

TC-8C ..... \$129.95     JBUG (EPROM) .... \$34.95  
                                  JBUG (Cassette) ..... \$29.95

TERMS:  
Cash, Master Card or Visa  
Shipping & Handling \$3.50(US)  
\$5.50 (Canada) \$15.00  
(Foreign) Technical  
Inquiries: Phone  
5:00 - 6:00 PM MST



Phone (505) 294-4623  
12021 Paisano Ct. NE  
Albuquerque, NM  
87112



## A WORD FROM THE SPONSOR

Hi again. This is Month Three in my series of short chats about various Color computer subjects in these Star-Kits ads. Hope you are finding them interesting and useful.

Quite often, after running a machine language program, I find that my CoCo doesn't want to accept Basic programs. The common solution, of course, is to turn the power off and then back on. This does a complete reset of the computer and fixes some of the pointers which the machine language program clobbers.

But here's a better way that doesn't put your computer through the power on/off stress: simply type POKE 113,3 and push the RESET button on the back. The POKE makes Basic forget that it has already been reset before, so pushing the RESET forces it to go through the same complete reset as if power had first been applied.

In fact, I have one Basic program which does several CLEARs and PCLEARs that leave the computer in a state where it won't run other programs unless everything is reset. To avoid the need to manually reset the system after this program is finished, I added one last line which reads POKE 113,3 : EXEC 40999. The EXEC restarts Basic exactly the same as if I had pressed RESET (except for one difference — in a 64K system you must physically press RESET to return from 64K mode back to 32K mode after running a 64K program.)

Are you using a non — Radio Shack tape recorder with your CoCo? If so, then it's quite possible that the motor control relay in your CoCo is not able to handle the recorder motor current. When that happens, the computer can't turn off the motor because the relay contacts have welded together. The new CoCo models have a better motor control relay to fix the problem, but what about the rest of us?

If the relay doesn't get to the point where the contacts are permanently stuck together, then it's possible to solve the problem by adding a simple circuit between the computer and the recorder. It uses just a few parts readily available at your local Radio Shack — send us a self-addressed stamped envelope for a free diagram and instructions. (Hope you don't mind if we enclose a Star-Kits catalog too, while we're at it.)

If you're into engineering or math, you might be interested in our new educational package. Introduction to Numerical Methods is a college sophomore level course which combines a 324-page text with a number of Basic programs which go along with the text and illustrate each topic. Some knowledge of calculus is required, and the package covers a variety of topics in numerical analysis. This is probably the most painless way to learn a very useful topic; at \$75 it's quite a bit cheaper than going to college.

Finally . . . if you have purchased a Star-Kits program, please make sure to return the user registration form from your manual along with an envelope. We periodically send out our Users' Group Newsletter with other hints and kinks, and these forms and envelopes are our only way of keeping you up to date.

See you next month.

## SPELL 'N FIX

Regardless of whose text processor you use, let SPELL 'N FIX find and fix your spelling and typing mistakes. It reads text faster than you can, and spots and corrects errors even experienced proofreaders miss. It is compatible with all Color Computer text processors, including Telewriter and Radio Shack's Scripsit! (See the review in 80 Micro, November 1982.) \$69.29 in the Radio Shack disk or cassette versions; \$89.29 in the Flex version. (20,000 word dictionary is standard; optional 75,000 word Super Dictionary costs \$50 additional.)

## HUMBUG — THE SUPER MONITOR

A complete monitor and debugging system which lets you input programs and data into memory, list memory contents, insert multiple breakpoints, single-step, test, checksum, and compare memory contents, find data in memory, start and stop programs, upload and download, save to tape, connect the Color Computer to a terminal, printer, or remote computer, and more. HUMBUG on disk or cassette costs just \$39.95.

## STAR-DOS

A Disk Operating System specially designed for the Color Computer, STAR-DOS is fully compatible with your present Color Computer disk format — it reads disks written by Extended Disk Basic and vice versa. But with STAR-DOS you can use machine and assembly language programs to do things Basic can't. Just \$49.95.

## ALL IN ONE — Editor Etc.

Three programs in one — a full function Editor for text or program files; a Text Processor for formatting and printing text files with centering, justification, and paging, and a Mailing List and Mailing Label program which can even generate individually addressed letters for each person (or selected persons) on your mailing list. All this for just \$50. Requires STAR-DOS and 32K.

## DBLS for Data Bases

DBLS stands for Data Base Lookup System. A super-fast system for searching for a selected record in a sequential disk file. Supplied with SPELL 'N FIX's 20,000 word dictionary as a sample data file — lets you look up the spelling of any word in under FOUR seconds. Priced at \$29.95. Requires STAR-DOS.

## CHECK 'N TAX

Home accounting package combines checkbook maintenance and income tax data collection. Written in Basic for either RS Disk or Flex, \$50.

## REMOTERM

REMOTERM — allows full operation of the Color Computer from an external terminal. \$19.95.

## NEWTALK

NEWTALK — a memory examine utility for machine language programmers which reads out memory contents through the TV set speaker. \$20.

## SHRINK

SHRINK — our version of Eliza, in machine language and extremely fast. \$15.

## OXOX

OXOX — our version of Othello, also machine language and fast. \$15.

We accept cash, check, COD, Visa, or Master Card. NY State residents please add appropriate sales tax.

# STAR-KITS

P.O. BOX 209—R  
MT. KISCO, N.Y. 10549  
(914) 241-0287

# Screen Control

By R. N. Roberts

Unfortunately, I'm seldom able to express myself in tidy little sentences of 32 characters or less, and frequently my print lines do runneth over to the next line on the TV screen. Nothing wrong with that, but when a word gets split in the process, I see Color Code 4 (to you beginners and unfortunates with other machines that's red). I hate to think of the time I've spent counting characters and inserting blanks in print statements in order to push a split word back to the start of the next line. If you feel the same, the following subroutine (named *Screen Control*) will provide relief.

Another equally useful feature of *Screen Control* is its ability to automatically stop printing when the screen is full. This feature lets you view text printed by a program one screen at a time. No longer do you have to sit with your fingers on the "shift" and "@" keys, poised like a cobra to strike in that one split second when the new lines reach the top of the screen. (It is unfortunate that there is not a similar routine in ROM for use when listing a Basic program.) *Screen Control* eliminates the need to count how many lines will fill a creen and then insert the familiar:

```
PRINT "HIT ENTER TO CONTINUE"; INPUT
A$:CLS
```

## Using Screen Control

To use *Screen Control*, first *CLEAR* 500 bytes of string storage space. The extra memory is the price paid for the subroutine. Next set the string you want to print equal to *Z\$* and execute a *GOSUB* to the subroutine. (I reserve the use of the letter *Z* for variables used in utility programs to avoid

---

***"No longer do you have to sit with your fingers on the 'shift' and '@' keys, poised like a cobra to strike in that one split second..."***

---

inadvertently using a variable in a program and a utility at the same time.) That's all there is to it.

A semicolon placed at the end of a *PRINT* string will cause the following material to start printing at the end of the first string. The same effect is achieved in *Screen Control* by directing the *GOSUB* to line 150. For the same effect as a *PRINT* without the semicolon, *GOSUB* to line 140.

If you enter the subroutine with a string which would normally cause the screen to scroll, *Screen Control* will print as much of the string as it can, print a prompt on the bottom line and then beep. Hitting the *ENTER* key will clear the screen and the remainder of the string will be printed at the top of the screen. If you use lower case letters for the prompt it will readily attract the eye of the user. If you use this subroutine in a program which does not have to be very user friendly you might consider changing the prompt to "more" or even "--)".

Should you desire to disable the screen paging feature, replace lines 290 and 310 with *RETURN* statements and delete line 300. To use the page control part of the program only, set your strings equal to *ZZ\$* and execute a *GOSUB* to line 290.

As listed, statements 20 to 130 are not necessary to the operation of the program. If you *RUN* the program after keying it in, lines 20 to 130 illustrate the working of the subroutine. After you experiment with the program you will want to delete them.

## How It Works

All you folks who only want to copy and compute can go to work now. From here on out, it's going to be a nuts and bolts discussion of how the program works. First, the variables used are defined in Table 1.

Table 1

### SCREENCL variables

ZW—Flag for printing. 0=Print; 1=Print  
 Z\$ —Text string to be processed  
 ZZ\$—The part of Z\$ to be printed  
 ZI.—Print positions between cursor location and end of line  
 ZS—Number of characters in string Z\$  
 ZR—Number of unprinted characters in string.

Next a review of the *POS* function. *POS*(0) returns the position of the cursor on a screen line. The values returned by *POS*(0) are "0" for the start of a line and "31" for the end of a line.

The *POS* function only tells where the cursor is in a line. In order to completely establish the location of the cursor on the screen, it is necessary to get the cursor address from memory locations 136 and 137. Memory addresses require two bytes of storage and are converted to a decimal value by the formula:

$$256 * PEEK(1st\ byte) + PEEK(2nd\ byte)$$

or, in this case:

$$\text{Cursor address} = 256 * PEEK(136) + PEEK(137)$$

The cursor address will be a number between 1024 and 1535, the beginning and end of text screen memory.

If you do not have Extended Color Basic, the *POS* function can be duplicated by the following code used as a subroutine:

$$1000\ PO = 256 * PEEK(136) + PEEK(137)$$

ROBOTTACK and COLORPEDE

ROBOTTACK

# COLORPEDE

This truly outstanding engineer designed, 100% machine language game with multi-colored high resolution characters and fast action will challenge the most avid arcade buff. Can be played by 1 or 2 players controlled with joy sticks or key board. Joy stick control is fast, smooth and accurate. As COLORPEDE slithers through the toad stools, you attempt to destroy the COLORPEDE, knock out the menacing Bouncing Bug and eliminate toad stools while accumulating higher and higher scores. Demonstration mode with top 5 scores. Pause feature. For 16K Color Computer and TDP-100.

Cassette - \$29.95

Disk - \$34.95

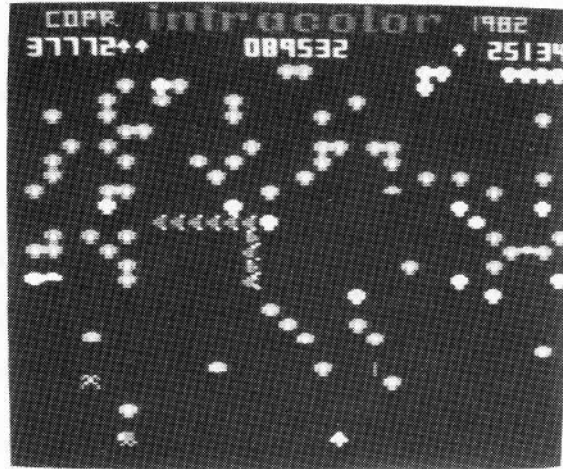

Actual Photo

### WHAT THEY ARE SAYING ABOUT COLORPEDE

"... forefront of the pack ..." **the Rainbow**, Dec. '82

"... the best graphics and playability of any color computer game ..." McKeesport, PA

"It is great!" Dayton, OH

"... an outstanding offering." N. Vernon, IN

"... the best graphics I have seen to date." Erie, PA



SETTING THE STANDARDS

INTRODUCING

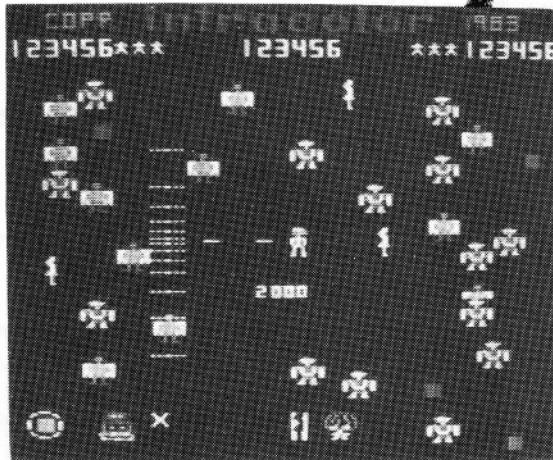

Actual Photo

# ROBOTTACK

Ultra fast arcade action with colorful high resolution graphics. You are the super human who must fight off the attacking robots and save the remaining humans from destruction. You have super powers, can shoot in any direction and move anywhere on the screen to accomplish your vital mission.

Engineer designed, 100% machine language. Can be played by 1 or 2 players with joy stick control. Top 5 scores displayed. Pause feature. For 16K Color Computer and TDP-100 with joy sticks.

Cassette - \$24.95

Disk - \$27.95

**TO ORDER:** VISA, MASTERCARD, Money Order. Please allow 2 weeks for checks. Add \$1.50 for shipping, \$3.00 outside U.S. 4% tax in Mich.

DEALER INQUIRIES INVITED.



FOR THE COLOR COMPUTER & TDP-100



1010 PO=PO-32\*INT(PO/32)

1020 Return

Upon return from this subroutine the variable PO will have the same value as would be returned by POS(0).

Statement 10 clears the required string space. Statements 140 to 280 are the string handling part of the program and statements 290-310 are the page control sections.

### String Handling Subsection

Statement 140 sets ZW=1 indicating that semicolon type printing is not desired. ZW is checked in statement 270 after all the string is printed. Statement 270 will return control to the calling program if ZW=0, leaving the cursor at the end of the string. Otherwise, line 280 resets ZW to zero and, if the cursor is not on the last line, skips to the start of the next line by executing a PRINT statement.

Statement 150 adds a blank to the end of a string on the screen if the cursor is not at the beginning of the line and the first character of the new string is not a blank.

Statement 160 deletes a leading blank from a string if the string will be printed at the beginning of a line. If you want to indent a line, use one more leading blank than you would when using a regular PRINT command. ZL is set equal to the number of print positions between the cursor and the end of the line in statement 170. Statement 180 sets ZS equal to the number of characters in the string to be printed.

Statement 190 prints the string if it will fit between the cursor and the end of the line. Printing in this statement, as well as other statements, is done by setting the string to be printed equal to ZZ\$ and executing a GOSUB to statement 290, the page control part of the program. If printing occurs at statement 190, all the string has been printed and control

goes to statement 270 which, as mentioned above, determines if semicolon printing is required.

Statements 200 through 240 are the heart of the program. If the character which would be printed at the end of the line or the next character is a blank, then a word is not split. In this case, the original string, Z\$, is broken in two parts. The left part is printed in the balance of the line the cursor is on, ZR is set equal to the number of unprinted characters, and control goes to statement 210 which redefines Z\$ as the right part of the string and starts the process over again by transferring control to line 150.

If the character which would print at the end of the line and the next character are not blanks, then a word is split and control goes to statement 220 which steps backward through the string starting at the end of line character until it finds a blank or reaches the start of the string. When a blank is found, the left portion of the string up to that point is printed on the line the cursor is on. ZR is then set equal to the number of unprinted characters and control goes to statement 210. If a blank is not found, it means that the word is too big for the space remaining in the line, and control passes to statement 250 which skips to the next line unless the cursor is on the last line. Issuing a PRINT command when the cursor is on the last line will cause the top line to scroll off the screen which, of course, is a no-no. If the cursor is on the last line, control goes to the page control section of the subroutine to print the prompt.

### Page Control Subsection

Statement 290 is the first line of the page control section. If the present cursor location plus the length of the string to be printed is greater than 1512 then control goes to statement 310 to print the prompt. 1512 is the text screen address a few characters before the prompt. Color Basic users can replace the LINE INPUT instruction in statement 310 with an INPUT statement. I used LINE INPUT to avoid printing the question mark after the prompt. After the user responds, the screen is cleared, the waiting string is printed at the top of the screen, and control returns to the main program.

That's all there is to it. Now you can have neat text displays with a minimum of programming effort.

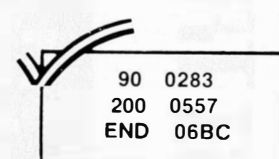

The listing:

```
10 CLEAR500
20 '*****
30 'SCREEN CONTROL BY R.ROBERTS
   8/82
40 '*****
50 CLS
60 Z$="LINES 20 THROUGH 130 ARE
   NOT NEEDED FOR THE SUBROUTINE. T
   HEY DEMONSTRATE HOW THE SUBROUTI
   NE WORKS. THE FIRST TIME THIS ST
   RING APPEARS IT IS SHOWN AS IF P
   RINTED BY A PRINT STATEMENT. THE
   SECOND TIME IS THE SUBROUTINE'S
   WORK.
70 PRINTZ$:PRINT:GOSUB140
```

# Q SOFT

## PRESENTS

- **3D TIC-TAC-TOE** •

*NEW!! Over 150 possible ways to win. A real challenge. Just when you think you won, coco beats you to it. A first for the coco.*

Cassette: 32K E.C.B. .... \$14.95  
Disc: 32K E.C.B. .... \$19.95

- **TIC-TAC-TOE** •

*If you thought Tic-Tac-Toe is an easy game, try matching your wits against this version. Play it with or without joysticks. A special "SMALL FRY" level of difficulty is provided.*

Cassette: 16K C.B. .... \$10.95

- **JUMPS** •

*Q-SOFT's challenging version of a very old European solitaire game. An ADDICTIVE board game in HI-RES graphics. Reviewed in Jan. 1983 issue of the "RAINBOW" on page 164.*

Cassette: 16K E.C.B. .... \$10.95  
Cassette: 4K C.B. .... \$ 8.95

- **THE SPIDER** •

*By: CHROMATIC SOFTWARE" All machine language. Annihilate the spider before he destroys you. Arcade action. Joysticks needed. Reviewed in Jan. 1983 issue of the "RAINBOW" on page 160.*

Cassette: 16K ..... \$19.95

- **ONE CHECK** •

*48 "CHECKERS" are placed on the two outside rows of a standard checkerboard. Remove as many "checkers" as possible, jumping diagonally. Play with or without joysticks. HI-RES graphics.*

Cassette: 16K E.C.B. .... \$10.95

**Q-SOFT**  
1006 ROBINHOOD DRIVE • PAINESVILLE, OHIO 44077  
C.O.D. orders add \$3.00 Call 216-352-2675

```

80 GOSUB310
90 Z$="THIS STRING CONTAINS 245
CHARACTERS AND FILLS ABOUT 8 SCR
EEN LINES. ONE STRING THIS SIZE
WILL FILL ABOUT HALF THE SCREEN.
USING THIS SUBROUTINE ELIMINATE
S THE NEED FOR SEVERAL PRINT STA
TEMENTS IN A PROGRAM JUST TO ASS
URE PROPER SPACING AND FORMA
100 GOSUB140:GOSUB310:Z$="DO YOU
KNOW THAT YOU DON'T HAVE TO PUT
A QUOTATION MARK AT THE END OF
A STRING IF IT WILL BE THE LAST
CHARACTER IN THE LINE?":GOSUB140
110 Z$="NEXT A DEMONSTRATION OF
HOW A LINE CAN BE PUT AT THE END
OF THE PRECEEDING LINE OR HOW I
T CAN START A NEW LINE. THE DIFF
ERENCE BEING WHICH LINE THE GOSU
B CALLS.":GOSUB150
120 Z$="THIS IS AN ADD ON LINE T
HE FIRST TIME IT APPEARS. THE SE
COND TIME IT STANDS ALONE.":T$=Z
$:GOSUB140:Z$=T$:GOSUB140
130 GOTO130
140 ZW=1 '***HERE FOR PRINT
150 IFPOS(0)<>0ANDLEFT$(Z$,1)<>"
" THENPRINT " "; '***HERE FOR PR
INT;

```

```

160 IFPOS(0)=0ANDLEFT$(Z$,1)=" "
THENZ$=RIGHT$(Z$,LEN(Z$)-1)
170 ZL=32-POS(0)
180 ZS=LEN(Z$)
190 IF ZS<=ZL THENZZ$=Z$:GOSUB29
0:GOTO270
200 IF MID$(Z$,ZL,1)=" " ORMID$(
Z$,ZL+1,1)=" " THENZZ$=LEFT$(Z$,
ZL):GOSUB290:ZR=ZS-ZL ELSE220
210 Z$=RIGHT$(Z$,ZR):GOTO150
220 FOR ZR=ZL TO 1 STEP -1
230 IF MID$(Z$,ZR,1)=" " THENZZ$=
LEFT$(Z$,ZR):GOSUB290:ZR=LEN(Z$)
-ZR:GOTO210
240 NEXTZR
250 IF256*PEEK(136)+PEEK(137)+LE
N(ZZ$)<1503 THENPRINTCHR$(8):GOT
O150
260 GOSUB310:GOTO150
270 IF ZW=0 THENRETURN
280 ZW=0:IF256*PEEK(136)+PEEK(13
7)>1503 THENRETURN ELSEPRINT " ";
CHR$(8):RETURN
290 IF256*PEEK(136)+PEEK(137)+LE
N(ZZ$)>1512 THENGOSUB310
300 PRINTZZ$;:RETURN
310 PRINT@490,"hit enter to cont
inue";:SOUND200,1:LINEINPUTZI$:C
LS:RETURN

```

## Design a training program to bring you to your top speed— with RUNCALC

Written by Bill Brown, a former coach and 2:47 marathoner, RUNCALC is an invaluable aid to distance runners of all ages and ability levels.

### RUNCALC can help you:

- Evaluate your training quality
- Compare performances of different lengths
- Find pace per mile, per quarter-mile, per meter, etc.
- Find speed in miles/hr., meters/sec., ft/sec.
- Do metric conversions
- Generate split times for goal distances and times
- Set meaningful goal times for interval training
- Calculate calorie usage for a given run.

RUNCALC was designed for the Tandy Radio Shack TRS-80 Color Computer. It is an easy to use menu-driven program requiring 16K Ext. Color Basic and is supplied on cassette with guide for only \$12.95 including postage. Indiana residents include 4% sales tax.

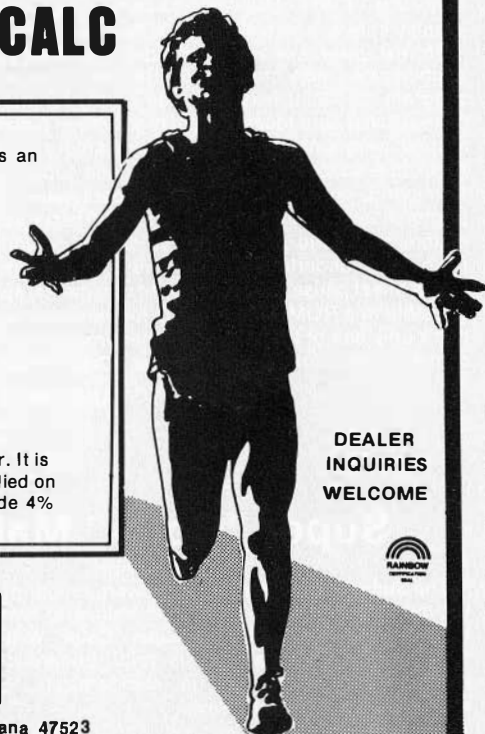

DEALER  
INQUIRIES  
WELCOME



SEND CHECK OR MONEY ORDER TO:

# HOME RUN

COMPUTER PRODUCTS

Box 511 Dale, Indiana 47523

# Super "Color" Library™

For the TRS-80 Color and TDP System 100 Personal Computers

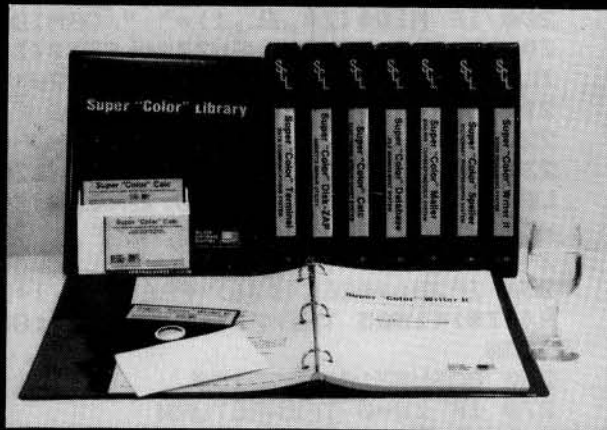

No matter what kind of problem you are trying to solve with the Color Computer, there is a program in the ever-expanding integrated, **Super "Color" Library** that will give you the solution; Faster, Better, Smarter!

Every Library program features **MEMORY-SENSE** to determine your computer's memory, from 16 to 64K, and adjusts automatically to maximize work space. All programs, except the **Super "Color" Speller** and **Super "Color" Disk-ZAP**, feature a true lowercase display with below line descenders. Each program has been written specifically for the Color Computer in fast machine code to be totally compatible for optimum performance — Something a motley assortment of programs from diverse sources or a passel of overpriced, wallet-FLEXing software from a bygone era simply can not achieve.

The **Super "Color" Library** has all the power, speed, dependability and compatibility you will ever need so build your library a volume at a time or put the full power of the complete library of problem solvers to work right away.

**64K**  
Compatible

— NEW! —

## Super "Color" Writer II™

VERSION 3.0 By Tim Nelson  
THE INTELLIGENT WORD PROCESSOR

32x16 &  
51-64-85x21  
WITH REAL  
LOWERCASE  
DISPLAY

The **Super "Color" Writer II** is for those who desire the best. It is the most powerful, fastest, most dependable and versatile word processor available for the Color Computer, from 16 to 64K. The **Super "Color" Writer II** has features for the most demanding professional, yet it is easy enough for newcomers to master.

Of course the **Super "Color" Writer II** has all the features you would expect from the highest quality word processor, such as a clear, crisp and readable professional display with your choice of display colors, 4 display formats; standard 32x16 & 51-64-85x21 with real lowercase and descenders: full 4-way cursor control, sophisticated edit commands, the ability to edit any BASIC program or ASCII textfile, seven delete functions, locate and change, wild card locate, a real block move & copy, word wrap-around, programmable tabs, display memory used and left, non-breakable space, multiple headers and footers, dynamic text formatting, comprehensive format parameters, use with ANY printer at any baud rate from 110 to 9600 baud, automatic justification, automatic pagination, automatic centering, automatic flush right, underlining, superscripts, subscripts, pause print, single-sheet pause, optionally print comments, append text files, available in a ROMPAK cartridge for maximum work space, but that's only half of the story. No other program can even begin to compare in features with the **Super "Color" Writer II**.

### Check These Exclusive Features

**MEMORY-SENSE** adjusts to computer's memory (16-64K) for maximum work space; **TYPE-AHEAD**, **TYPAMATIC KEY REPEAT** and **KEY BEEP** for the pros; 3 **PROGRAMMABLE FUNCTIONS**: **AUTO PHRASE INSERT**; **COLUMN CREATION**; **TEXT FILE LINKING**; **HELP MENU**; **A TRUE EDITING WINDOW IN ALL 4 DISPLAY MODES**; **TRUE FORMAT WINDOW** to display line lengths up to 255 characters, with horizontal and vertical scrolling to replicate the printed page including centered lines, headers, footers, page breaks, page numbers, margins, giving a perfect printed document every time. Also makes hyphenation a snap; **TRUE AUTOMATIC JUSTIFICATION** for neat, even left and right hand margins; Ability to use **CHARACTER CODES** for printing special characters available with your printer; freedom to embed as many **PRINTER CONTROL CODES** as desired anywhere in the text, **EVEN WITHIN JUSTIFIED TEXT**; 90-plus page tutorial manual.

**ADDITIONAL DISK FEATURES**: Read a directory, Display free granules, Save with Automatic Verification, Load and Append ASCII files, and BASIC programs, Kill files, and Link files from disk for continuous printing. 54K bytes of workspace available with a 64 K system. Only the best offers all of these features.

TAPE \$69.95      ROMPAK \$89.95      DISK \$99.95

Tutorial only \$15.00 (Refundable with purchase)  
Tape & Disk require 32K for lowercase display  
Previous **Super "Color" Writer II** owners call for upgrade policy.

## Super "Color" Mailer™

By Tim Nelson

The **Super "Color" Mailer** is a powerful multi-purpose mailing list merging and sorting program including lowercase display that uses files created by the **Super "Color" Writer II**. Combine files, sort and print mailing lists, print "Boilerplate" documents, automatically insert text in standardized forms, address envelopes, the list is endless.

TAPE \$39.95      DISK \$59.95  
Operators Manual only \$10.00 (Refundable with purchase)

## NEW Super "Color" Speller™

By Peter A. Stark

The **Super "Color" Speller** is a fast machine-code proofreading program to correct **Super "Color" Writer** files. Automatically proofreads your documents against a 20,000 word stock dictionary, plus your own customized dictionary and corrects typos or marks them for special attention.

AVAILABLE ON DISK ONLY \$69.95  
Operators Manual only \$10.00 (Refundable with purchase)

NELSON SOFTWARE SYSTEMS 9072 Lyndale Avenue So., Minneapolis, Minnesota 55420 612/881-2777



# 32x16 & 51-64-85x21 Display With Lowercase Descenders And **16** Thru **64K** Too! **Super "Color" Terminal™**

## **NEW** Super "Color" Calc™

ELECTRONIC SPREADSHEET By Kevin Herrboldt

Now you can answer those "What if?" financial projection, forecasting, budgeting, engineering and calculating questions with precision, speed and power using the **Super "Color" Calc**, truly the finest electronic worksheet and financial modeling program available for the Color Computer, from 16 to 64K. Now every Color Computer owner has access to a calculating and planning tool rivaling VisiCalc™, containing all its features and commands and then some. You need only change one variable and you instantly see how that change affects your assumptions. You can even use VisiCalc templates freely with **Super "Color" Calc**. Combine spread sheet tables with **Super "Color" Writer II** documents to create ledgers, projections, statistical and financial reports and budgets.

**Features Include:** 4 display formats; standard 32x16 & 51-64-85x21 with real lowercase and descenders \* MEMORY-SENSE to adjust to computer's memory (16-64K) for maximum work space; Full-size 63x256 worksheet \* Easy to use \* HELP Menus to make learning faster \* Machine code speed and high precision \* Total flexibility in calculating \* Up to FOUR VIDEO DISPLAY WINDOWS to compare and contrast results of changes \* Sine and Cosine functions, Averaging, Exponents, Algebraic functions, and base 10 or 16 entry \* Multi-layered Column and Row Ascending and Descending sorts \* Locate formulas or titles in fields \* Easy entry, replication and block moving of frames \* Global or Local column width control up to 81 characters each \* Create titles of up to 255 characters \* Typematic Key Repeat \* Key beep \* Type-ahead \* Print up to 132 column worksheet \* Prints at any baud rate from 110 to 9600 \* Print formats savable along with worksheet \* Enter control codes for customized printing.

**DISK FEATURES:** Read a directory; Display free granules; Kill files, Save with Automatic Verification; Load files; Append disk files for complete worksheet printing. 55K bytes of worksheet space available with a 64K system.

Tutorial and sample templates are supplied with the program.

**ROMPAK \$89.95** **DISK \$99.95**

Tutorial only \$15.00 (Refundable with purchase)  
Tape & Disk require 32K for lowercase display.

## Super "Color" Disk-ZAP™

By Tim Nelson

Now the dreamed-of repair of I/O errors is a reality. The **Super "Color" Disk-ZAP™** is the ultimate repair utility for simple and quick repair of all repairable disk errors. Designed with the non-programmer in mind, the **Super "Color" Disk-ZAP™** will let you retrieve all types of bashed files, including BASIC and Machine Code programs.

This high-speed machine code disk utility has a special dual cursor screen display to show HEXIDECIMAL and ASCII displays simultaneously. You are able to: Verify or modify disk sectors at will \* Type right onto the disk to change unwanted program names or prompts \* Send sector contents to the printer or any other RS-232 device \* Search the entire disk for any grouping of characters \* Copy sectors \* Backup tracks or entire disks \* Repair directory tracks and smashed disks \* Full prompting to help you every step of the way \* 50-plus page Operators Manual which helps you simply and quickly fix the vast majority of disk errors, and teaches the rudiments of disk structure and repair.

**AVAILABLE ON DISK ONLY \$49.95**

Operators Manual only \$10.00 (Refundable with purchase)

**NELSON™  
SOFTWARE  
SYSTEMS**

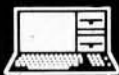

9072 Lyndale Avenue So. 612/881-2777

A Division of Softlaw Corporation Minneapolis, Minnesota 55420 U. S. A.

TRS-80 is a trademark of Tandy Corp. VisiCorp is a trademark of VisiCorp.

**WE TAKE THE COLOR COMPUTER SERIOUSLY.  
AUTHORS' SUBMISSIONS ARE ENCOURAGED.**

**THE FINEST TERMINAL PROGRAM ANYWHERE!  
Version 3.0 By Dan Nelson**

The best has become even better, with many new features including 4 display formats; 32x16 & 51-64-85x21 with real lowercase descenders, plus compatibility with the 64K Color Computer. This user-friendly program makes communicating with ANY computer a breeze even for a newcomer. Communicate using your modem with all the popular information services such as Dow Jones, CompuServe, The Source, and local BBS's, clubs, friends, or the main-frame at work. You can also communicate directly with other microcomputers, such as the TRS-80 I/III, II, other Color Computers, Apples, IBM PCs, etc., via RS-232 without using a modem. Save the information or PRINT IT! **FEATURES:** MEMORY-SENSE to adjust to computer's memory (16-64K) for maximum work space; Selectively print data at baud rates from 110 to 9600 \* 60K of data storage with 64K disk system. 128 character ASCII keyboard \* Automatic graphics mode \* Word mode (word wrap) for unbroken words \* Send & receive **Super "Color" Writer II, Database & Calc** files, ASCII files, Machine Language & BASIC programs \* Set communications baud rate from 110 to 9600, Duplex: Half/Full/Echo, Word length: 5 6 7 or 8, Parity: Odd/Even or None, Stop Bits: 1-9 \* Local linefeeds to screen \* Save and load ASCII files, Machine Code & BASIC programs \* Unique CLONE feature for copying any tape \* Lower case masking \* 10 Keystroke Multiplier (MACRO) buffers to perform repetitive pre-entry log-on tasks and send short messages \* Programmable prompt or delay for send next line \* Selectable character trapping \* Files compatible with other Library programs.

**ADDITIONAL DISK FEATURES:** Works with up to four Disk Drives; Call a directory, Print free space, Kill disk files, Save with Automatic Verification and Load textfiles or BASIC programs; Save and Load KSM'S to the disk.

**TAPE \$49.95** **ROMPAK \$59.95** **DISK \$69.95**

Operators Manual only \$10.00 (Refundable with purchase)  
Previous **Super "Color" Terminal** owners call for upgrade policy.

## **NEW** Super "Color" Database™

By Dan Nelson

This high speed machine language program including true lowercase displays fills all your information management needs, be they for your business or home. Inventory, accounts, mailing, lists, family histories, you name it, the **Super "Color" Database** will keep track of all your data!

The **Super "Color" Database** features MEMORY-SENSE to adjust to computer's memory (16-64K) for maximum work space. It is structured in a simple and easy to understand menu system with full prompting for easy operation. Your data is stored in records of your own design, each divided into as many fields as you need. All files are fully indexed for speed and efficiency. Full sort of records is provided for easy listing of names, figures, addresses, etc., in ascending or descending order. The math package performs arithmetic operations and updates other fields which is especially useful when used as an order entry and invoicing system. You can create reports, or lists for mailings, or whatever. Create files compatible with the **Super "Color" Writer II and Terminal**. Up to five different print formats are available, and control codes may be imbedded for customized printing.

**AVAILABLE ON DISK ONLY \$79.95**

Operators Manual only \$10.00 (Refundable with purchase)

**For Orders ONLY Call Toll Free**



**1-800-328-2737**



Customer service and product support call (612) 881-2777.

MAIL ORDERS: \$3 U.S. Shipping (\$4 CANADA, \$10 OVERSEAS)

Personal checks allow 3 weeks. **ORDERS SHIPPED SAME DAY!**

**Available at Dealers everywhere.**

**If your Dealer is out of stock ORDER DIRECT!**

## Final Countdown

### Save The World—Don't Blow It

By Paula Giese

When I first started gaming, I didn't do too well. I was always trying to HUG DWARF, KISS GIANT (I like big guys), or FEED DRAGON (an endangered species, after all). And though I like Adventuring, the constant need to KILL, STAB, SHOOT, HIT, and so on, is wearisome. The hero-gamer always seems to be a man, often bent on rescuing some tedious, chunky little princess-type who's tied up someplace. Off-putting for us tall, fast-moving ladies.

In real life, I am a private detective; I do have what I suppose some would consider "adventures." In real life, these are boring, scary, cold, slow, heartbreaking. Most are best handled with a smile, fundamental respect for people, and a cool head. I don't carry a gun. I've worked to end war for a long time, so shoot 'em-ups and galactic war games hardly thrill me, though unlike the present Administration, I don't think video games are causing kids to beat up on (or shoot) their folks any more than usual. Hence, I was delighted to see a game whose purpose was for the

protagonist to *prevent* a war, rather than to knock out some alleged baddies with smart bombs, lasers, and what-not; or to get anti-social against ethnic minorities (dwarves, ogres) with more old-fashioned technologies.

Bill and Debbie Cook have written an interesting all-text Adventure called *Final Countdown* which starts you outside a missile base, where a crazed General is about to launch a nuke, targeting Moscow and starting World War Final, if you can't abort the thing.

You have to get into the base—there's automatic security at the gate. Then, find the right tools as you make your way through secret passages, mazes, administrative offices, and a variety of techno-rooms, to the place where you can abort the launch. That is, if you don't launch it yourself, by mistake, or get killed by making mistakes with the hi-tech gadgetry or by using the wrong tools at the wrong time. Computers, a two-way radio, and radar screens give you some scoop, if you interrogate them right. You can ask for HELP, but you won't get much.

From time to time, the crazed General pops up. If you don't get him, he'll get you, then that's all, world. Still, true to your anti-death principles, while you *do* shoot him (if you see him in time), it's with a Taser gun, a techno device developed out of the old electric cattle prod, once beloved of Southern sheriffs. Although cop catalogs advertise them, they're not much good. Most are sold to easy marks through ads in masculine righteous-violence fantasy mags like *Soldier of Fortune*. Nonetheless, your Taser causes the General to run off whimpering for a little while. But he keeps randomly popping up. You have only five shots before your battery is dead.

## CASSETTE SOFTWARE

Quan.

all games run on 16k non-extended basic

<input type="checkbox"/>	GHOST GOBBLER .....	\$ 21.95	\$ .....
<input type="checkbox"/>	PLANET INVASION .....	21.95	.....
<input type="checkbox"/>	GALAX ATTAX .....	21.95	.....
<input type="checkbox"/>	DEFENSE .....	21.95	.....
<input type="checkbox"/>	SPACE RACE .....	21.95	.....
<input type="checkbox"/>	SPACE WAR .....	21.95	.....
<input type="checkbox"/>	ROBOT BATTLE .....	21.95	.....
<input type="checkbox"/>	KEYS OF THE WIZARD .....	19.95	.....
<input type="checkbox"/>	CCTHELLO .....	14.95	.....
<input type="checkbox"/>	COLOR ZAP .....	9.95	.....
<input type="checkbox"/>	MONKEY KONG .....	24.95	.....
<input type="checkbox"/>	PHANTOM SLAYER .....	19.95	.....
<input type="checkbox"/>	INVADERS REVENGE .....	19.90	.....

Shipping ..... Free

Total ..... U.S. \$ .....

Amount Enclosed Ck. or M.O. \$.....  
 Name .....  
 Address .....  
 City .....  
 State ..... Zip .....

Mich. residents add 4 %

Mail to:

Bear Bones Software  
 G-3117 Corunna Rd. Suite 108  
 Flint, Mich. 48504

clip & mail

I typed something a bit off-color the first time my Taser quit. This didn't phase the program, which told me primly, "Your French is not impressive." There is a subroutine prepared (named ' &%\$!' )\$%\$! ! ! ) for a couple of other "French" words you might happen to use. Like other subroutines, or modules, it's introduced with a name—REM, so unravelling the BASIC spaghetti into components of the program is fairly easy, if you want to analyze it later.

In *Final Countdown* you're racing against a countdown, a given number of turns before there's a rumble, the earth opens, the missile launches, and bye-bye. You can ask: SCORE? for how many turns you have remaining. "How can you worry about points at a time like this?" the program chides you—but it tells. There are three levels of difficulty—Novice, Average, Expert, all menu-selected. Experts get less time and more appearances of the psycho General, so it remains playable against time and previous scores even after you've "solved" it. You can QUIT at any time, but you can't SAVE games part-way through for later resumption from where you were.

There are no graphics, in a way disappointing, but what can you "show" for the end of the world? And a modest "NICE GOING" with your score is surely all the reward you need for winning, what with your world-savior's glow and all. Trumpets, flashing screens, Presidential citations would be, ah, overkill. By the way, don't expect any help from the White House in this game. When you find and USE the Red Phone—the White House hotline—a recorded message tells you it's after working hours, call back the next day, after doomsday.

A nice feature is the fixed-screen status window, protected by a machine-language routine *POKEd* into the main BASIC program. The window shows the "current scene" and direction choices, and is updated to reflect the results of each move you make, including taking objects. On the "action screen," the two-thirds lying below the window, you talk to the program and it answers you. The previous commands and replies scroll upwards till they go behind the window, so half-a-dozen previous moves and replies stay visible. This is a great help in mazes and learning the routes through the missile base. "INVENTORY" will tell you what you're carrying at any time, at the cost of a countdown penalty.

The General will suddenly pop up randomly in the window, while you're busy reading or typing on the action screen, below, and may not notice him. If you make your next move without Tasing him, he's gotcha, that's it.

This "pop into the status window" technique is the program's main formal novelty. Such an updating status window is common on large business and word-processing applications programs, and in the new \$50 million Apple LISA. In *Adventures*, though, it permits the use of random game factors to which the player can immediately respond, with varying results, an effect I hope to see other *Adventures* use, as it adds a lot of interest. The usual random game factor just knocks you out, handicaps, or (rarely) helps you in a fixed way; there's nothing you can do about it, the factor's outcome is predetermined in its effect on the game.

What the Cooks have done, in effect, is invent not a new technical, but a new literary device. They use it here in a very simple way, but later it can be developed with more complexity (random factors interacting with and altering screen-scene status; interacting with other game characters; new forms of Magic). What it does—or can do—is add a new dimension to what distinguishes computer games from little books or short films—the interactiveness of the story and you, the protagonist of that story.

The main program is in BASIC, so you can "cheat" by

# AT LAST

## Real Arcade Joysticks For Co-Co

Just plug in our adaptor (below) and use your ATARI® joysticks or for REAL ARCADE action . . . get one of ours!

➔ Made by WICO® ➔ 

**COMMAND CONTROL adaptor** 1995



- Radio Shack®\* TRS80® Color Computer
- Uses one or two joysticks
- Adaptor needed for all joysticks

**COMMAND CONTROL joysticks** 

- Injection-molded modular construction and 6 leaf-type molded switches — identical to the best commercial arcade models.
- Two fire button locations, activated by a base-mounted slide switch.
- Extra-long 5' cord.

**Joystick 15-9714** 2995



- Extra-long arcade-style bat handle grip that moves smoothly and easily into all 8 standard positions.
- Low-profile, heavy-duty plastic base.

**Famous Red Ball™ Joystick 15-9730** 3495



- Arcade-type red ball handle that moves smoothly and easily into all 8 standard positions.
- Low-profile, heavy-duty plastic base.

**COMMAND CONTROL trackballs\*** 6595



- Features injection-molded modular construction.
- Phenolic ball provides unique 360 degree movement to an infinite number of positions; can also be used to vary the speed of on-screen objects.
- Quick-action fire button next to the ball, for smooth, two-handed control.

\*AC power supply included.

**COMMAND CONTROL extension cords**

12' length—15-1756 895

6' length—15-1755 595

All backed by a full one-year limited manufacturer's warranty.

**SPECIAL**

**ATARI**

**JOYSTICKS**

\$9.50 each/2 for \$18.00

\* \* \* \* SOFTWARE \* \* \* \*

In March **ZAXXON** by Datasoft

from SHELL **DEATH STAR "An Adventure" 32K/ECB** 1995  
A text adventure that's different

**SUB—HUNT Arcade type 16K/ECB (Low Res.)** 995

from TOM MIX **DONKEY KING 4 full screens. Just like the ARCADE - Super!!** 2495

**\$** FREE 16K Adv. game with \$50 order **\$**  
Orders under \$50-add \$2.50 shp/hnd.  
Write for other software available.

----- VISA/MC, CK, MO -----  
9 to 5 EST (305) 894-1887

**S & S ARCADE SUPPLIES**

8301 Sarnow Dr. / Orlando FL 32807  
Ph: (305) 275-8490 Evenings  
-Fla. res. add 5% sales tax-  
VISA/MC add 3%



# HOMEBASE™ THE COMPLETE TRS-80\* COLOR COMPUTER DATABASE

HOMEBASE™ PROVIDES WORD PROCESSING, DATABASE MANAGEMENT, AND SPREAD SHEET CALCULATIONS, IN ONE EASY TO USE PACKAGE. SOME OF THE MANY USEFUL APPLICATIONS OF HOMEBASE™ INCLUDE:

• *Check book management* • *Ledgers* • *Grocery lists* • *Shopping lists* • *Article indexing* • *Recipes* • *Disk directories* • *Notes* • *Memos* • *Letters* • *Phone lists* • *Customer lists* • *Business contact lists* • *Appointments* • *Mailing lists* • *Home inventory* • *Car maintenance scheduling* • *Income tax preparation* • *Address lists* • *Charts* • *Newsletters* • *Athletic team records* • *Form letters* •

#### WORD PROCESSING FEATURES INCLUDE:

- DEFINE 250 screens of text you can search, sort, display, and print using names you assign or using any word or phrase.
- EDIT text by duplicating, moving, clearing, searching and replacing, deleting, or reordering entire records of text or any word or phrase.
- FORMAT labels, memos, letters, and other documents for printing with embedded printer controls for paging, skipping lines, and changing character fonts. Program controls provide setting; right and left margins, lines per page, page width, horizontal tabs, and line spacing.

#### DATA MANAGEMENT FEATURES INCLUDE:

- DEFINE 50 data fields, including a comment field, in a single record. Dates, time of day, phone numbers and dollar amounts are automatically formatted. You may also define 24 scratchpad data fields.
- REORGANIZE records by moving data fields within records or by moving records within the file. You may sort records using names you assign or data.
- MANAGE files by searching, deleting, clearing, duplicating, and displaying any data field or record. Add, subtract, multiply, divide, or summarize any data field. Use any command on any selected group of data fields and/or records.
- PRINT files using automatic formatting with options to print report titles, a report date, page numbers, record names, and data field names. Print all or selected data fields or records. Use standard or compressed print. Use a special print option to print the comment field as a mailing label.

#### UTILITIES FOR WORD PROCESSING AND DATA MANAGEMENT INCLUDE:

• *Generating new files from old files* • *Merging files* • *Duplicating files* • *Moving data between files* • *Summarizing files* • *Moving files from diskette to diskette using one drive* • *Saving files to cassette and reloading from cassette* • *File synchronizing* • *Print disk directory* •

#### HOMEBASE™ IS EASY TO USE:

- NO PROGRAMMING REQUIRED. All options are displayed in menus. HOMEBASE™ automatically requests all required data and edits every entry.
- All commands are single key stroke.
- FULL screen editing for text entry.
- Complete cursor control for entering names, titles, notes, and comments.
- 100 pages of instructions with complete descriptions of each command, and examples.
- Requires 32K of memory, disk basic and only one disk drive. NO equipment modifications required.
- All programs reside entirely in memory.
- Fast response to all commands including search and sort.

### ORDER TOLL FREE

Credit card holders call toll free: 800-334-0854 extension 887

In North Carolina Call 800-672-0101 extension 887

or send a check or money order for \$75.00 plus \$5.00

for handling charges to:

HOMEBASE™ COMPUTER SYSTEMS

P.O. Box 3448

Durham, N. C. 27702

N.C. residents add 4% for sales tax. Allow 1 to 3 weeks for delivery.

HOMEBASE™ is a trademark of HOMEBASE™ COMPUTER SYSTEMS, a subsidiary of Small Business Systems, Durham, N.C. (919) 544-5408.

\*TRS-80 is a trademark of Tandy Radio Shack Inc.



LLISTing it to learn verbs, objects, places, and outcomes. It's for a 16K ECB machine; on a 32K machine you need not *PCLEAR* before *CLOADING*. A backup program is supplied on the cassette. The program is warranted against defects for 60 days after purchase. I found a couple of *apparent* bugs. Occasionally, the program would tell me, "WOW! LOOK WHAT YOU FOUND!" But no matter how much I *LOOKed* or *EXAMined*, I couldn't find out what. Nor did various *TAKEs* or *MOVEs*, or *GOs* (with different objects) produce anything but "NOT RELEVANT." Additionally, you can *OPEN* certain things or *EXAMine* them when you're not really in their presence—a kind of *ESP* view of them—though you can't affect them unless you're there—a bug in the *OPEN/EXAMine* routines which makes it easy to cheat in certain ways, but seems unintended.

In summary, an interesting game, with a unique focus on taking risks to prevent war, rather than glorying in it. Though if you blunder (as I did), you must shoulder the responsibility for the nuclear destruction which follows, giving rise to some philosophical reflections on peace strategies, perhaps. (Although the General has it all set up to go anyway, all you do is speed up the end a bit.)

After playing it a while, by myself and with a drop-out priest who became an antiwar activist in the Vietnam era, and is now a programmer punching COBOL most nights, I was a byte disappointed. I expected too much, probably, of a game like this. I remembered hearing Father Daniel Berrigan speak in 1981, after he and the others of the Plowshare Eight had been convicted for entering the General Electric Plant at King of Prussia, Pennsylvania, smashing a number of Mark 12A multiple nuclear-warhead nose cones and pouring blood on them. Here's what he said:

"After much prayer and reflection, we eight decided that it was here and now for us. It was time to come down from being teachers, priests, writers, etc., and try to do something which might make a modest real difference in the world.

"Our religious tradition offers to life a slight edge over death, now. I often ponder what to say to be of help. It might be something as simple as this: Thou shalt not kill.

"Peace is something to be made, constructed, hammered out, not an ideology. It's very concrete, not a theory. It almost needs a hammer, tools. The government displayed a nuclear weapon nose cone in our courtroom. Looking at it was like looking at our doomsday, like looking at the end of the world."

By comparison with the real, slow-moving, often disheartening moral adventures of quietly courageous people, *Final Countdown* is, of course, trivial. But it's only a game. In my view, it's very preferable to a game in which the player plays to destroy abstract worlds of abstract people, using make-believe verbal and graphics devices not much simpler to unleash-and-destroy-with than the real world-killer weapons that politicians play with.

*Final Countdown* is as realistic in its way as are the techno-war games it is a counterweight to. There *are* non-game-players who really do these things. For the rest of us,

(Jarb Software, 1636 D Avenue, Suite C, National City, CA 92050, \$14.95 on cassette)

# Superior Graphic Software Products

HOME OF MOTION PICTURE PROGRAMMING

NATIONALLY ACCLAIMED PROGRAMS FOR THE

**TRS-80<sup>®</sup> COLOR COMPUTER<sup>®</sup>**



## TALKING GRAPHIC DEMONSTRATION

When someone sees your CoCo and asks "Just what does this thing do?" then load TALKING GRAPHIC DEMO and let your computer do its own show and tell, complete with musical background and a running commentary. As quoted in THE RAINBOW, "This is, frankly, better than anything the people who sell the machines have."

Extended color basic. Tape only ..... \$24.95

## THE DISK DOCTOR

DISK DOCTOR.....That disk with the vital information you forgot to back up just crashed! Don't PANIC. Take 2 aspirin, count to 10, and put in an emergency call for THE DISK DOCTOR. This program will salvage machine language, BASIC, data, ASCII, even MPP pictures. Completely menu driven for easy use. As 80 MICRO REVIEWER states "I feel safer when creating important files and programs having the DOCTOR 'on call!'"  
DOS only ..... \$49.95

## MPP-TUTORIAL

MPP-TUTORIAL.....The programming tool of the professionals. You may not be a great artist, but you too can produce stunning, high resolution graphics. Detailed step by step instructions to create near studio quality animation. Quote CHROMASETTE, "...if you want to see and use the full graphic potential for your CoCo, this program is required!"

Extended color basic - specify tape or disk ..... \$34.95

## EL CASINO

EL CASINO....Three startling, action-packed high resolution graphic games, ideal for den and rumpus room parties. Games are programed with MPP graphics, and each is over 14k long.

### DICE GAME..

..This is the only craps game on the market that allows 4 players to make any or all of 12 field bets before every roll. The graphic banker automatically tracks and displays bets as they are made. True Casino action on your CoCo.

### BLACK JACK..

..The famous card counter not only shows the cards remaining in the deck, but computes the odds on hitting your hand with the cards remaining. Las Vegas rules apply. All this with MPP graphics and super sound effects.

### SLOT MACHINE..

..Looks and sounds like a Casino machine. The arm drops, the windows roll, and the pay off (if any) hits the tray with a nice "clunk". Adjustable odds...make it easy on yourself if you like.

Extended color basic. Specify tape or disk ..... \$34.95



POSTAGE PAID  
P.O. BOX 451 CANTON, NC 28716.  
For Fast Service Call 704/648-6015



\*TRS-80 Trademark Tandy Corp.

# Analysis of Variance— A ‘Nova’ for CoCo

By Sam Sherrill

*Manufacturers may install power into the computer, but it is the programmer who gives it strength. And while many have provided the games (and good ones, too) for our amusement, programmers such as Sam Sherrill have helped extend the basic capabilities of our computer by developing its quantitative nature through programs and tutorials related to statistical analysis, science and education.*

*The author is on the faculty of the School of Planning at the University of Cincinnati, where he teaches research and statistics courses.*

The purpose of analysis of variance (ANOVA) is to reveal differences among samples that are *not* due to chance. The usual procedure is to test the assumption that the samples are alike. Statisticians call this assumption the null hypothesis. They also label differences that seem unlikely to occur by chance as statistically significant differences. Thus, in the language of statistics, ANOVA is used to test the null hypotheses.

If the null hypothesis is supported by the ANOVA results then we may conclude that the populations from which the samples were taken are also alike. For example, we could compare examination scores among classes of students exposed to different teaching methods to test the idea that methods affect learning. The specific classes we select are our samples. The null hypothesis would be accepted as true when no statistically significant differences are found among the exam scores for the classes. This means the variation among the class scores is not explained by variations among the methods we tested. In a more general sense, this result also means that these methods are unlikely to affect exam scores of all other similar students.

If the null hypothesis is contradicted by the ANOVA results then we may conclude that the populations are different. In our example, the null hypothesis that methods have no effect on learning would be rejected since ANOVA revealed statistically significant differences among the class scores. We can conclude that variations among teaching methods do help explain differences among class scores. We can also conclude that these methods would produce differences among other similar students.

ANOVA is an extension of the difference-of-means test (DOM). The DOM test is used to compare two samples to one another. (When just two are compared, an ANOVA and DOM tests lead to the same conclusion.) The DOM test is useful when we have specific hypotheses to test using two particular samples. For example, we would use this test if we

expected one teaching method to produce higher scores than another. Using ANOVA on all classes would tell us whether there is a difference among them but would not identify the source of the difference. In general, the ANOVA test is often best suited for exploratory comparisons among three or more groups while the DOM test is more appropriate for specific pair-wise comparisons.

Exploratory comparisons often must be made among samples of unequal size. If the classes in our example were selected from a large population of such classes then it is quite likely that they will not contain the same number of students. ANOVA tests based on arrays (such as the one offered by Bruce Douglass in the December 1982 issue of *80MICRO*) require equal sample sizes. The only way to use this kind of program when sample sizes are not equal is to

---

***“In general, the ANOVA test is often best suited for exploratory comparisons among three or more groups...”***

---

reduce all of the samples down to the size of the smallest one. However, this also reduces the capacity of the test to reveal differences. In addition, the memory demanded by this kind of program grows as the number of samples or sample sizes grow.

To avoid these problems, I wrote an ANOVA program for the Color Computer that does not use arrays. Basically, I took the ANOVA formula for unequal sample sizes apart algebraically and reassembled it in a way that uses running totals instead: thus, any number of samples of either equal or unequal size can be compared. This program requires just over 3K of memory, regardless of the number of sizes of the samples. It will run on machines with 16K and Extended





SINCE 1981

A BRAND NEW GAME AND ONLY FROM ZETA

### WORMHOLE™

by John Bobst

*An original all-machine-language game  
for the TRS80 Color Computer:*

- \*1 to 4 players (taking turns,  
"in-progress" savable)
- \*6 distinct sound effects  
(7 if counting "foosh")
- \*1 joystick and 16K either  
BASIC required (average?)
- \*8 colors on a black screen  
(Semigraphics 12)
- \*1 "pause" key, 1 exit key, and  
1 reset key (handy)
- \*255,999,999 points possible  
(not @#%&! likely)
- \*9 speeds/skill-levels  
(changeable during play)
- \*4 copies on 1 cassette  
(disk savable/loadable)
- \*1 source only  
(at a "factory direct price")

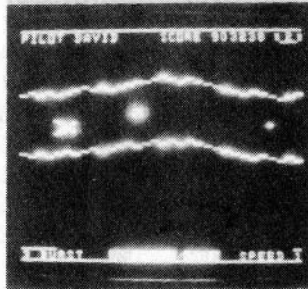

A great description for \$29.95, but **WORMHOLE** is a great game for only

**ZETA SOFTWARE**  
\$17.95 + 2.50 S&H P.O. Box 3522  
(\$20.45) to: Greenville, S.C. 29608

FREE catalog with order or write or call. No COD's, PO's or charge cards, please. TRS80™TANDY Corp. **WORMHOLE**™  
ZETA Computer — Phone: (803) 246-1741 — 1-9 p.m. EST.

GET A CATALOG FOR INFO ON YET ANOTHER  
NEW PROGRAM: "EL CHEAPO™ AND CONVERTER"

**ZETA SOFTWARE**  
**P.O. BOX 3522**  
**GREENVILLE SC 29608-3522**

Color BASIC.

The program calculates the F-Value (the quotient of the variance among samples divided by the variance within samples) and the probability of that value occurring by chance. It then compares this probability to the traditional significance levels of .05, .01, and .001. When the probability is greater than .05, the differences among the samples are labeled as insignificant and the null hypothesis is accepted. When the probability is less than .001, the differences are labeled as significant and the null hypothesis is rejected. Finally, when the probability of a particular value falls between .05 and .001, the program indicates that the differences may or may not be significant and suggests that you may wish to withhold judgment on whether to accept or reject the null hypothesis. By pressing any key, the program then prints the usual results of an ANOVA: the total, among, and within results for the sum of squares and degrees of freedom; estimates of the among and within variances; the F-Value; and, the probability of the F-Value occurring by chance.

```

150 0235
250 04F6
330 08F5
END 0B40
  
```

The listing:

```

10 CLS
15 PRINT"
"
  
```

\*\*\*\*\*ONE WAY\*\*\*\*\*

```

20 PRINT"*****ANALYSIS OF VARIA
NCE*****"
  
```

```

25 PRINT"
  
```

WRITTEN BY"

```

30 PRINT"
  
```

SAM SHERRILL"

## THE SOFTWARE SHOP

**(617) 339-3734**

*We Specialize In Color Computer Programs  
Call or Write For Our Catalog*

ARCADE STYLE	UTILITIES	EDUCATIONAL
Pac Attac	Tape to Disk	Spelling
Galax Attax	Disassembler	Math
Storm	Assemblers	Geography
ADVENTURE	PERSONAL	BUSINESS
Madness & Minatour	Budget	Word Processing
Keys of the Wizard	Household Expense	Inventory
El Diablario	Stock Analysis	Gen. Ledgers

*Over 100 Different Programs in Stock!*

## THE SOFTWARE SHOP

200 Chauncy Street  
Mansfield, MA 02048

\*Visa and M.C. Accepted\*

```

35 PRINT"          3578 ZUMSTEIN A
VE
40 PRINT"          CINCINNATI, OH 45
208"
45 FOR TM=1 TO 750:NEXT TM:CLS
50 REM **DATA INPUT**
55 PRINT"NUMBER OF SAMPLES":INPU
T SP
60 FOR I=1 TO SP
65 PRINT"NUMBER OF MEASURES FOR
SAMPLE  NUMBER";I:INPUT N:FOR J
N=1 TO N
70 PRINT"MEASURE";JN
75 INPUT A
80 FOR KN=1 TO A
85 REM **DATA ANALYSIS**
90 P=P+A
95 M=M+A^2
100 NEXT JN
105 R=P/N
110 GOSUB 500
115 C=C+P
120 D=D+N
125 V=(M-N*R^2)
130 W=W+V
135 M=0:N=0:R=0:P=0
140 NEXT I
145 CLS
150 ZG=C/D
155 Q=D*ZG^2
160 U=E*ZG
165 B=(H+Q)+U:IF H=Q THEN 170 EL
SE 175
170 PRINT"THERE IS LITTLE OR NO
VARIATION AMONG THE"SP"SAMPLES:
THUS, THE VALUE OF F IS CLOSE T
O 0. THE NULL HYPOTHESIS WHICH
ASSERTS THERE ARE NO DIFFEREN
CES AMONG THE SAMPLES IS ACCEPT
ABLE.":GOTO 410
175 O=B/(SP-1)
180 W1=W/(D-SP):IF W1>0 THEN 190
ELSE 185
185 PRINT"THERE IS NO WITHIN-SAM
PLE VARIATION: THUS, THE F
-RATIO CANNOT BE CALCULATED."
:GOTO 410
190 F=O/W1:IF F<.001 THEN 170 EL
SE 195
195 SS=B+W
200 D1=SP-1:D2=D-SP
205 S=D1
210 T=D2
215 DF=S+T
220 Z=F
225 J=2/9/S
230 K=2/9/T
235 Y=ABS((1-K)*Z^(1/3)-1+J)/SQR
(K*Z^(2/3)+J)
  
```

# Color Computer Expansion Interface

**NOW SHIPPING!**



## COMPARE THESE FEATURES!

- **RS DISK COMPATIBLE** — NO modification required
- **64K Memory access circuit** (for 32K Rev-E computer) — NO modification needed
- **Parallel PIA port** — Drives printer or I/O — leaves RS-232 available for modem, etc.
- **Expansion port** — selects up to 7 more peripheral cards
- **Aluminum chassis** — saves space — computer slides under — TV on top — Room for Expander Card and up to 4 peripheral cards.
- **Additional I/O cards . . . available January 1983**

- CX-2010A Quad Parallel I/O Port (2 M6821 PIAs) . . . . . \$99.95
- CX-2016A Speech Synthesizer (Votrax phoneme system) . . . . . \$129.95

*. . . more peripheral cards on the way!*

CX-2001A EXPANDER CARD (REQUIRES CX-2401A) . . . . .	\$139.95
CX-2401A EXTENSION RIBBON CABLE . . . . .	\$29.95
CX-3001A ALUMINUM CHASSIS (IDEAL FOR STAND ALONE USE) . . . . .	\$49.95
<b>CX-P1—INTRODUCTORY OFFER — PACKAGE PRICE . . . . .</b>	<b>\$199.95</b>

PA RESIDENTS ADD 6% SALES TAX

INCLUDE \$3.50 FOR SHIPPING & HANDLING WITHIN THE CONTINENTAL U.S. ADD \$1.50 FOR C.O.D. CHARGES.



**General Automation**  
9600 Roosevelt Blvd., Suite 100-LL  
Philadelphia, PA 19115  
(215) 934-3758



```

240 IF T<4 THEN Y=Y*(1+.08*Y^4/T
^3)ELSE 245
245 X=.5/(1+Y*(.196854+Y*(.11519
4+Y*(.000344+Y*.019527))))^4
250 X=INT(X*10000+.5)/10000
255 X=1-X
260 REM **RESULTS OF DATA ANALYS
IS**
265 PRINT"THE PROBABILITY AN F-V
ALUE OF ";
270 PRINTUSING"#####.###";F;
275 PRINT" WOULD OCCUR BY CHANCE
IS "1-X"."
280 PRINT"THE TRADITIONAL SIGNIF
ICANCE LEVELS ARE .05, .01, .
001."
285 IF 1-X> .05 THEN 300 ELSE 29
0
290 IF 1-X < .001 THEN 310 ELSE
295
295 IF .05 >=1-X OR 1-X=>.001 TH
EN 315
300 PRINT"BY THESE STANDARDS, TH
E F-VALUE ABOVE IS NOT SIGNIFICA
NT AND NEITHER ARE THE DIFFER
ENCES AMONG THE";
305 PRINTUSING"###";SP;:PRINT" SA
MPLES; THUS, THE NULL HYPOTHESI
S OF NO DIFFERENCE IS ACCEPTABLE.

```

```

": GOTO 320
310 PRINT"BY THESE STANDARDS, TH
E F-VALUE ABOVE IS SIGNIFICANT,
AS ARE THE DIFFERENCES AMONG THE"
;:PRINTUSING"###";SP;:PRINT" SAMP
LES; THUS, THE NULL HYPOTHESIS IS
RE-JECTED.": GOTO 320
315 PRINT"BY THESE STANDARDS, TH
E F-VALUE ABOVE MAY OR MAY NOT B
E SIGNIFI-CANT SINCE THE PROBABILI
TY OF ITS OCCURENCE FALLS BE
TWEEN .05 AND .001. YOU MAY WISH
TO WITH- HOLD JUDGMENT REGARDIN
G THE ACCEPTANCE OR REJECTIO
N OF THE NULL HYPOTHESIS.
320 PRINT"*PRESS ANY KEY FOR A D
ISPLAY OF THE RESULTS.*"
325 A$=INKEY$: IF A$<>" " GOTO 34
0 ELSE 330
330 GOTO 325
335 REM **RESULTS IN TABULAR FOR
M**
340 CLS
345 PRINTTAB(12)"SUMS OF SQUARES
"
350 PRINT@32,"TOTAL";:PRINTTAB(1
1)"";SS
355 PRINT@64,"AMONG";:PRINTTAB(1
1)"";B
360 PRINT@96,"WITHIN";:PRINTTAB(
11)"";W
365 PRINT@128,;:PRINTTAB(12)"DEG
REES OF FREEDOM"
370 PRINT@160,"TOTAL";:PRINTTAB(
11)"";DF
375 PRINT@192,"AMONG";:PRINTTAB(
11)"";S
380 PRINT@224,"WITHIN";:PRINTTAB
(11)"";T
385 PRINT@256,;:PRINTTAB(12)"EST
IMATE OF VARIANCE"
390 PRINT@288,"AMONG";:PRINTTAB(
11)"";O
395 PRINT@320,"WITHIN";:PRINTTAB
(11)"";W1
400 PRINT@352,"F-RATIO";:PRINTTA
B(11)"";F
405 PRINT@384,"PROB(F)";:PRINTTA
B(11)"";1-X
410 PRINT"*DO YOU WISH TO RUN TH
E PROGRAM AGAIN: Y OR N?": INPU
T L$: IF L$="Y" THEN 415 ELSE 42
0
415 RUN
420 END
500 G=N*R^2:H=H+G
505 L=-2*N*R
510 E=E+L
515 RETURN

```

# Aurora Software

43 BROOKLAND AVE  
AURORA ONTARIO  
CANADA L4G 2H6

## FAMILY GAMES

For 16K AND 32K COLOR COMPUTER

STOCKBROKER-Up to 6 players can play the stock market. For 16K or 32K ECB. The 32K is in High-Res Graphics. COLORMIND-Up to 4 players challenge for hidden colors. CRIBBAGE-For 2 or 4 players. In High-Res Graphics!(for 32K). CONCEN-Challenge the computer or a friend to a good ol' game of concentration. REMPREM-Challenge your friends. Who can remember the longest color sequence? BATTLE-Will you get bombed before you can find all the ships? An extremely entertaining game for the family.

ALL GAMES ONLY \$20.00 OR ANY TWO FOR \$35.00  
ALSO FROM AURORA SOFTWARE

MR.COPY-A quality copier written in M.L. that will make backup tape copies. MR.COPY is capable of making up to 99 copies in one loading! \$25.00

ROMDISK-If you have a modified 32K C.C. machine \$20.00 ROMDISK will allow you to load your R.S. Rom Packs from a disk! \$20.00





# PRICKLY-PEAR SOFTWARE

## QUALITY PROGRAMS FOR YOUR 80C

PROGRAMS REQUIRE 16K EXTENDED BASIC FOR TAPE, AND 32K DISK UNLESS OTHERWISE NOTED.

**ALL PROGRAMS IN THIS AD ARE  
NEW THIS MONTH.**



### Topsy Turvy

Word game enthusiasts take note!! This game pits you against other players and a relentless timer while you try to see how many 3, 4, 5, 6, or more letter words you can make from the 10 letters chosen at random by the computer. The more you get, the more you score, and you get bonuses if you do well. All scoring, timing, and record keeping is done by the computer. Sure the game is educational, but it's so much fun you'll never notice!! **TAPE \$19.95, DISK - \$24.95**

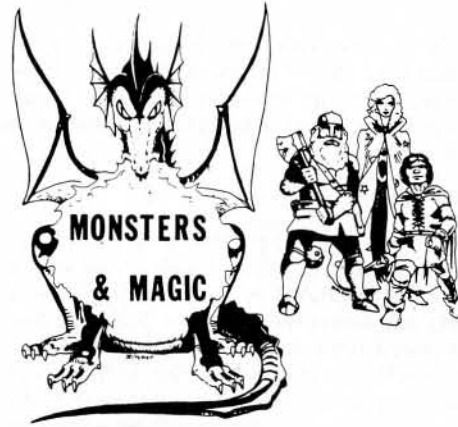

### Monsters & Magic

The most realistic fantasy role-playing game yet for the Color Computer. You start out by rolling up your character's basic ability scores and buying equipment. When you are ready it's into the dungeon. Your character starts at first level, but can rise in levels by garnering experience in the fray. If you have role-played fantasy games you will be amazed at the realism of the combat system. Armor class, initiative, and damage by weapon type are all included, with over 50 different monsters to fight - each with it's own abilities. As you rise in level you can win treasure and find magic weapons and spells - if you live!! You set the game length by telling how many monsters you want to fight before you reach your final battle to the death against the powerful Dungeon Lord. There are 1000+ place description combinations in this text based game, and real excitement in every one! This is a fantasy simulation, and is truly not like any adventure game you have ever seen. For 1 player; requires 32K extended BASIC. **TAPE - \$19.95, DISK - \$24.95**



ALL Programs in this ad, including disk versions, carry the Rainbow certification seal!

**Spanish** We know it's been a long wait, but you can finally use your Color Computer to learn a foreign language. This series of programs is very well done and educationally sound. You can use them in either a tutorial or test mode, and in the tutorial mode you can have the word on the screen while you listen to the correct pronunciation from the tape. The tape is controlled by the computer and the sound comes out the TV speaker. The complete Spanish course consists of 6 sets of lessons, with each set composed of 4 lessons. Each set comes with three cassette tapes (or one disk and two tapes in the disk version) and is complete in itself. When you finish the course - at your own pace, in the privacy of your home - you will have a conversational Spanish vocabulary of about 1100 words. Each set builds on the ones preceding, so you can stop at any time and still make full use of what you have learned.

#### SPANISH LANGUAGE COURSE

Set 1 (ready now) **TAPE - \$24.95, DISK - \$29.95**; Set 2 (ready now) **TAPE - \$24.95, DISK - \$29.95**

Sets 3, 4, 5 & 6 will be ready April 1, 1983, and each set will be **\$24.95 on Tape or \$29.95 on Disk**. The full course - all 6 sets - will be **\$124.95 on Tape or \$129.95 on Disk**, and will be ready April 1, 1983. We are already experiencing a heavy demand, so place your orders early. (Purchasers of Set 1 may order the remainder of the course within 30 days and pay the difference.)

COMING SOON — The same course in reverse - English instruction for Spanish-speaking people. Available approximately May 15, 1983.

Your Personal check is welcome - no delay. Include \$1.50 shipping for each program ordered. (Shipping free on \$50.00 or larger orders). Az. residents add 6% sales tax. Orders shipped within two days.

At Your Local Dealer, or

Send Order To: **PRICKLY-PEAR SOFTWARE**

9822 E. Stella Road  
Tucson, Arizona 85730  
(602) 886-1505

## 64K Modification For 'D' Board Both Easy, Inexpensive

By B. H. Alsop

Until now one had to either cut traces or buy a wolfbug 64K adapter card (\$150) to convert your 'D' series CoCo board to 64K. Here's how to do it for \$2 over the cost of the RAMs. Traces don't have to be cut and the modification can be easily removed.

### MODIFICATION

Purchase eight 16 pin dip sockets. Buy the type that will plug into each other. Solder a small gauge wire into each socket pin #9. Bend RAM IC pins 1,8 and 9 upward for all 64K RAMs and insert them into the prepared dip sockets. Solder the wire from socket pin 9 to IC pins 8 and 1. Your completed RAM socket assembly should look like Figure 1. Insert the completed assemblies into your CoCo RAM sockets. Solder all pin 9s together with wire and connect this bus to pin 35 of the 6883 SAM(U10) with a series 33 ohm resistor. Reconfigure the jumper block near the SAM to 16K. Remove the other jumper block. Solder a wire from pin 12 of U4 (6821 PIA) to pin 17 of U8 (96821 PIA).

Now proceed with the F. Hogg modification as described below

1. Remove U29 and U11 from their sockets. Bend pins 4,5 and 6 of U29 up. Bend pin 5 of U11 up.
2. Connect pin 8 to pin 6 of U29. Reinsert both ICs.
3. Connect pin 4 of U29 to pin 5 of U11. Connect a wire from pin 5 of U29 to TP1. Insert version 1.1 BASIC ROM.

Note that no capacitor leads are cut. In fact, the capacitors remain in the circuit to suppress power supply noise.

To remove the modification, unplug the IC assemblies, unsolder a few wires and insert new 74LS02 and 74LS138 ICs into U29 and U11 respectively.

### PROBLEMS

The only problem encountered has been with very old CoCo "D" boards (like mine). U11 and sometimes U29 are soldered into the PC board instead of being mounted in sockets. In this case, cut pin 4 of U11 flush with the board with a small pair of diagonal cutters. Bend the remaining IC lead upward. Another 74LS02 is prepared and then piggyback soldered on top of the existing U29. All pins except 7, 8, 9, 10 and 14 are removed. Only pins 7, 8, and 14 are soldered to U29. Pin 9 of this added IC is soldered to TP1 and pin 10 is soldered to pin 5 of U11. See Figure 2. In this case removal of the modification is only slightly more difficult.

### PERFORMANCE

I've installed five of these modifications on various vintage "D" boards. Even a few "E" series boards have been altered this way to permit easy removal for their owners. When installed you don't know that you ever had a "D" board CoCo. Good luck.

Figure 1. RAM Assembly

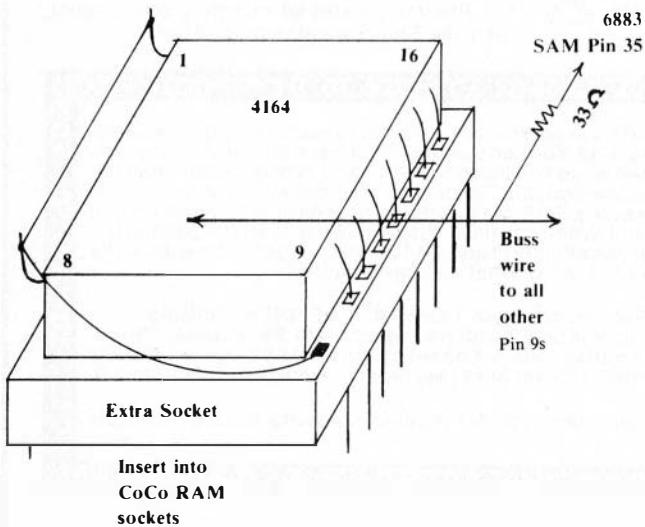
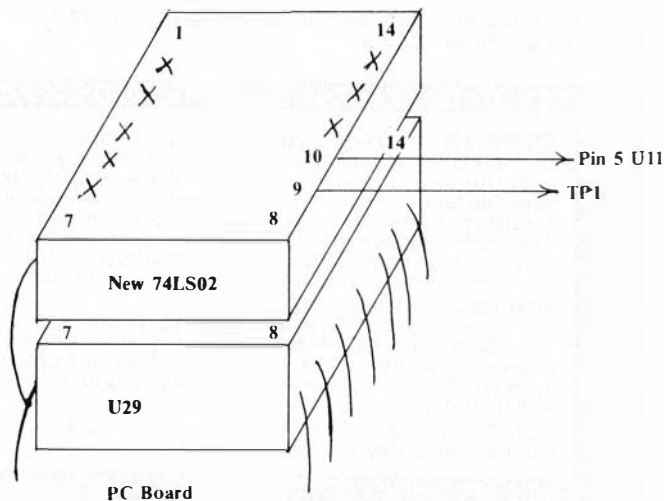

Figure 2. Piggyback



NOTE: Pins 7, 8, and 14 of new 74LS02 soldered to U29  
X denotes removed pin





**NOW!**  
**For Color Computer**  
**16K Extended BASIC**

## Dragonquest!

In a desperate race against the sun you search for SMAEGOR Monarch of Dragonfolk, who has kidnapped the Princess of the Realm and holds her in a distant and unknown place. In a quest for Honor and glory, you must search the land, seeking out the tools needed for the ultimate confrontation. On The River Delta, in the abandoned Temple of Baathteski, Goddess of the Blade, everywhere, clues abound. But WHERE is the Princess?

Now, as never before, the genius of CHARLES FORSYTHE shines in this new machine language ADVENTURE. DRAGONQUEST! Can YOU save M'lady from the iron clutches of SMAEGOR?

TAPE \$15.95

*Dealer Inquiries Invited*

DISK \$21.95

**THE PROGRAMMER'S GUILD**  
BOX 66, PETERBOROUGH, N.H. 03458  
(603) 924-6065 AFTER 6 PM EST

**MASTERCARD AND VISA ACCEPTED**



## Making and Rotating Rectangles

By Don Inman  
Rainbow Contributing Editor

This is the sixth of a series of articles on the graphic capabilities of Extended Color Basic on the TRS-80 Color Computer. It goes beyond the material that was covered in the book *TRS-80 Color Computer Graphics*.

Last month, we looked at a way to modify the output to the video screen so that the display would conform to the first quadrant of the Cartesian coordinate system. A method was shown to scale the Y coordinate so that X and Y units would appear to be the same length on the screen.

This article will continue using those techniques but will restrict itself to a specific shape, the rectangle. We will develop a very general program to define the rectangle in as simple a way as possible. At the same time, provision will be made to maintain flexibility when positioning the rectangle on the screen.

### PARALLEL RECTANGLES

A rectangle can be defined by two characteristics, its height and its width. In developing the first stage of our program let's limit the rectangle to one whose sides are parallel to the X, Y axes. We can remove that restriction after the basic program has been developed. If the length and width of the rectangle are known, the X,Y coordinates of one vertex (corner) determine where the rectangle appears on the screen.

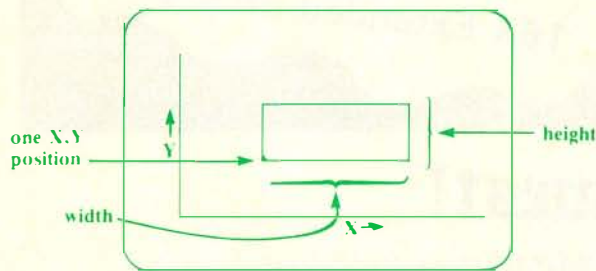

One input, the X, Y corner position, can be used to move the rectangle left or right and up or down (called a translation). Four pieces of information completely define the placement of the rectangle. The following variables are used:

- X0 = X coordinate of one corner position
- Y0 = Y coordinate of same corner
- H = height of rectangle
- W = width of rectangle

The length and width parameters can be used in the program to calculate the end-points of lines that make up the rectangle in the following way.

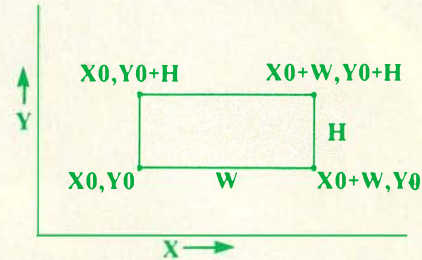

The following subroutine will define the corners of the rectangle. The lower left corner is PSET by DRAWSUB1, and the four lines are drawn by DRAWSUB2. Subroutines are used so that you may use them with any main program.

```

2000 REM *** DEFRECTSUB ***
2010 REM REQUIRES X0,Y0 THE COOR
    DINATES
2020 REM   OF ONE CORNER AND USE
    S
2030 REM   DRAWSUB1 AND DRAWSUB2
2040 GOSUB 3030 'DRAW AXES
2050 X1=X0:Y1=Y0:X2=X0+W:Y2=Y1
2060 GOSUB 3540 'DRAW LINE
2070 Y2=Y0-.8*H
2080 GOSUB 3540
2090 X2=X0
2100 GOSUB 3540
2110 Y2=Y0
2120 GOSUB 3540
2130 RETURN
2140 '
3000 REM *** DRAWSUB1 ***
3010 REM SETS LOWER LEFT CORNER
3020 REM   OF RECTANGLE
3030 Y0=181-.8*Y0: PSET(X0,Y0)
3040 RETURN
3050 '
3500 REM *** DRAWSUB2 ***
3510 REM DRAWS LINE FROM X1,Y1
3520 REM   TO X2,Y2 AND SETS
3530 REM   X1 TO X2 AND Y1 TO Y2
3540 LINE(X1,Y1)-(X2,Y2),PSET
3550 X1=X2: Y1=Y2
3560 RETURN
    
```



# COLORSOFT™

## ESCAPE

*A 3-D GRAPHICS ADVENTURE WITH SOUND  
(Machine Language for Fast Action)*

This is NOT the usual "find the treasure" adventure. In **ESCAPE**, you are trapped on the top floor of a skyscraper and the only way out is by using a very unusual elevator. You must give the elevator the correct code or else the ride down is a real killer. The maze-like halls seem to come to life due to the fantastic 3-D graphics. Search the halls for rooms which contain clues to the correct code. Clues must be deciphered to learn the elevator's secret code. Game times depends on the skill of the player, but it is typically 8-10 hours. **ESCAPE** is suitable for group play. A mentally stimulating experience.

16K BASIC \$18.95

## RECIPE FILE

*A CASSETTE BASED STORAGE AND  
RETRIEVAL SYSTEM*

This program permits storage of your favorite recipes for retrieval by your computer. Once a recipe has been recalled, then the computer can adjust the ingredient measure for serving the desired number of persons. Each recipe can contain special comments on preparation as well as the full instructions for using the recipe. Included is a line oriented text editor for creating and editing the variable length files. Completely menu driven and very user friendly. Easily modified by the user for use in keeping track of record, coin or stamp collections or whatever your interest. Screen or printer output.

16K Ext. BASIC \$21.95

**SPECIAL:** A collection of 30 recipes covering main meals to snacks. Only \$3.95 with program.

## SQUIRE

**SQUIRE** is a challenging game of asset management. The player must manage a country estate and contend with crop failure, investment losses, taxes and other such headaches. The object of the game is to increase the estate's value while providing for the peasant workers. The starting assets are computer selected so that each game offers different challenges. Great experience for the kids or aspiring executives.

16K Ext. BASIC \$14.95

## HOUSEHOLD EXPENSE MANAGER

This menu driven program package is designed for creating and maintaining a data file on cassette of 30 household expense categories for a 12-month period. It also keeps cumulative totals and a separate total of tax deductible expenses. A comparative analysis program provides a graphic presentation of relative expenses between any two months during the year. The user can change categories by modifying program code. Screen or printer output.

16K Ext. BASIC \$19.95

## FLIPPER

A fun and challenging version of the Othello™ type board games. This version includes options for play solely by the computer, one player against the computer, or two players against each other. The computer can play on four skill levels. Very colorful with plenty of sound. Fun for kids and challenging for adults. Great for parties.

16K Ext. BASIC \$16.95

## COLOR SOFTWARE SERVICES

P.O. BOX 1708, DEPT. R  
GREENVILLE, TEXAS 75401

---

INCLUDE \$2.25 HANDLING PER ORDER  
WRITE FOR FREE CATALOG

---

DEALER INQUIRES INVITED



TELEPHONE ORDERS  
(214) 454-3674  
9-4 Monday-Saturday

VISA/MASTERCARD



The main program consists of input data (lines 100-140), the graphic screen setup (lines 210-230 and line 260), drawing the axes (lines 240-250), a call to the subroutine (line 270), and an INKEY\$ instruction (line 290) where the computer holds the screen until you press a key. Pressing a key returns you to the beginning for more inputs.

```

X X 100 REM *** INPUT DATA ***
110 CLS
120 INPUT "HEIGHT";H
130 INPUT "WIDTH";W
140 INPUT "X,Y";X0,Y0
150 '
200 REM *** SET SCREEN; DRAW AXE
S ***
210 PMODE 4,1
220 PCLS1
230 COLOR 0,1
240 LINE (0,181)-(255,181),PSET
250 LINE (0,0)-(0,181),PSET
260 SCREEN 1,0
270 GOSUB 2040
290 IF INKEY$="" THEN 290 ELSE 1
10
300 '

```

It should be noted that a correction was made for the screen distortion (Y divided by X) in lines 2070 and 3030. This was discussed in last month's article. The main program is similar to that used last month.

## TYPICAL PARALLEL RECTANGLES

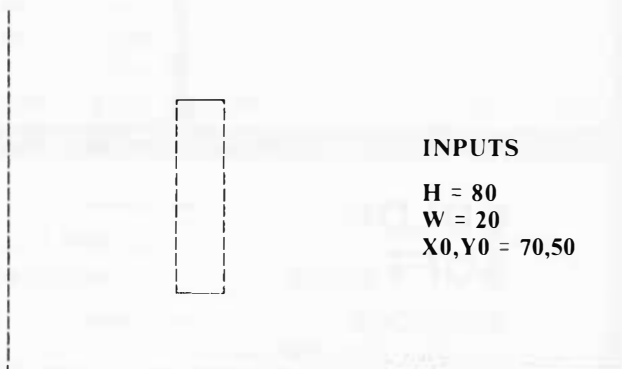
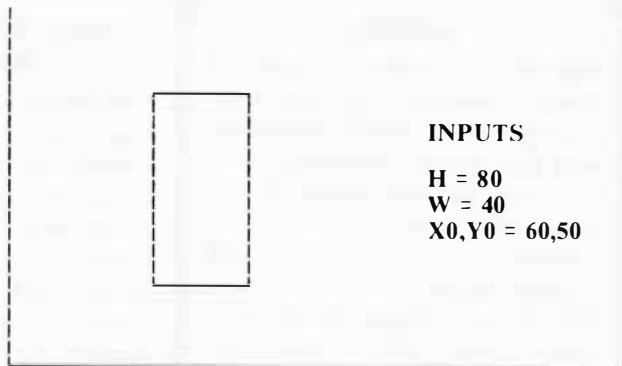
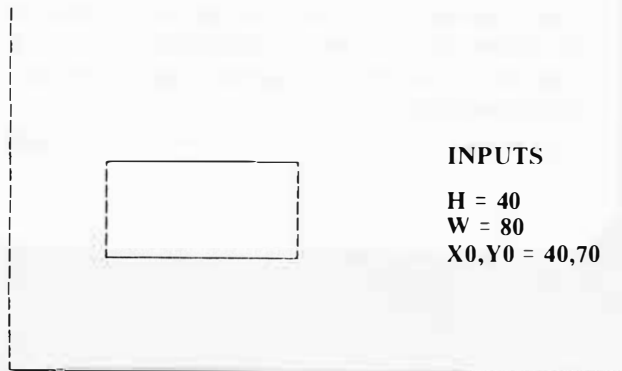
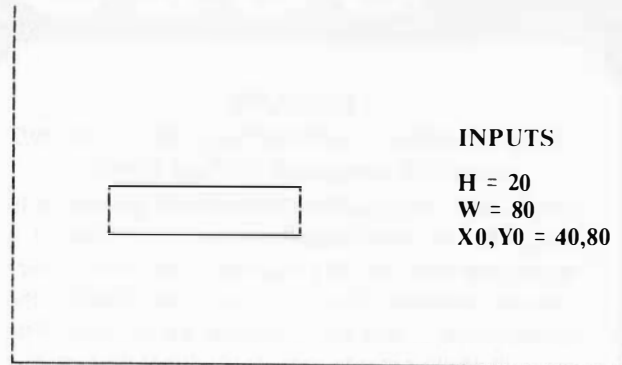



# ColorZAP™

**Use Color Power.**

ColorZAP uses the power of the Color Computer to provide both rapid scanning and full screen modification capabilities.

- Recover killed and clobbered files.
- Find unreadable disk sectors.
- Modify nibbles in hexadecimal.
- Copy sectors to same or different drive.
- Use color power to scan disk data.

Here's what the reviewers said...

About the program: "ColorZAP is a powerful program that allows you to see what is on the disk, modify it and, if possible, recreate it. Menu-driven, ColorZAP is extremely easy to use and well-documented...A good offering." — The RAINBOW, September 1982

About the manual: "A 24-page manual is included that describes program operation in detail. It also provides valuable information on the important disk system parameters." — MICRO, December 1982

For the TRS-80 Color Computer. Available on disk with an accompanying manual from **Software Options**, 19 Rector Street, New York, N.Y. 10006. 212-785-8285. **Toll-free order line: 800-221-1624.** Price: \$49.95 (plus \$2.00 per order shipping and handling). New York State residents add sales tax. Visa/Mastercard accepted.



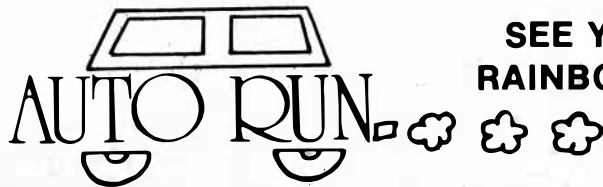

SEE YOU AT  
RAINBOWFEST!

Auto Run is a utility program for the TRS-80\* Extended Basic Color Computer. It is used to add convenience and professionalism to your software.

Auto Run will help you create your title screen with the graphics editor. The graphics editor allows you to choose a background color and border style. Using the arrow keys and several other commands you can draw pictures, block letters and also include text.

Auto Run will generate a machine language loader program to precede your program on the tape. Then, to start up your program, simply type CLOADM to load in the Auto Run loader program, which will then automatically start itself up, display your title screen, load your program and then RUN or EXEC it.

Also you may record a vocal or musical introduction preceding your program. The Auto Run loader will control the audio on/off.

Basic programs can be set to load anywhere in memory above \$600 (the PCLEAR 0 page).

Software authors: The Auto Run prefix may be appended to your software products.

Auto Run is \$14.95 and includes complete documentation and an assembly source listing. Requires 16K Extended Basic.

## Galactic Hangman

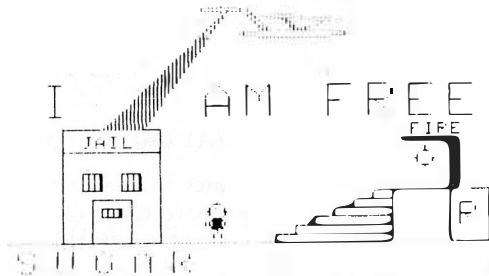

A great new twist to the popular, educational word guessing game for the Color Computer. Large (700 words) and sophisticated vocabulary. Or enter your own words, your child's spelling list, foreign language vocabulary, etc.

Outstanding high resolution graphics, animation and sound effects.

For \$14.95 you get both the 16K and 32K versions of Galactic Hangman.



## Tape Information Management System

A user-oriented, easy to use personal database management system for the TRS-80\* Color Computer with these outstanding features:

- \*keeps files of programs, names, addresses, birthdays, recipes, class or club rosters, anything
- \*variable record and field lengths
- \*phrase substitution editor
- \*up to 8 user-definable fields
- \*ML sort (up to 3 fields), search and delete functions
- \*2 search modes — range and item
- \*user-definable printer format, for any printer
- \*up to 230 characters per record

For \$24.95 you get the database management system, our full documentation which includes a reference guide and a programmer's guide, and our 1981 Bibliography of articles relating to the Color Computer. Requires 16K Extended Basic. 32K recommended.

1982 TIMS Bibliography — \$9.95

## Silly Syntax



A sensational and educational version of a popular party game for the TRS-80\* Color Computer . . .

For 1 to 10 players. Load a story into the computer. The players are asked to supply a noun, verb, part of body, celebrity, etc. which the program uses to complete the story. The story, which is displayed when all words are entered, will be hilarious. Silly Syntax requires 16K Extended Basic (32K for disk version). For \$19.95, you get a user guide and a tape containing the Silly Syntax game and 2 stories. You can create your own stories or order story tapes from the selection below.

**Silly Syntax stories — Ten stories per tape.**

- |                      |                           |
|----------------------|---------------------------|
| SS-001 - Fairy Tales | SS-004 - Current Events   |
| SS-002 - Sing Along  | SS-006 - Adventure/Sci-Fi |
| SS-003 - X-Rated     | SS-007 - Potpourri        |

Each story tape is \$9.95. 10% off for 3 or more story tapes. Disk is \$24.95 for Silly Syntax and 2 stories or \$49.95 for Silly Syntax and all 62 stories.



\*TRS-80 is a trademark of Tandy Corp.

**SUGAR SOFTWARE**  
2153 Leah Lane  
Reynoldsburg, Ohio 43068  
(614) 861-0565

CIS orders EMAIL to 70405, 1374

Add \$1.00 per tape or disk for postage and handling. Ohioans add 5.5% sales tax. COD orders are welcome. Dealer inquiries invited.

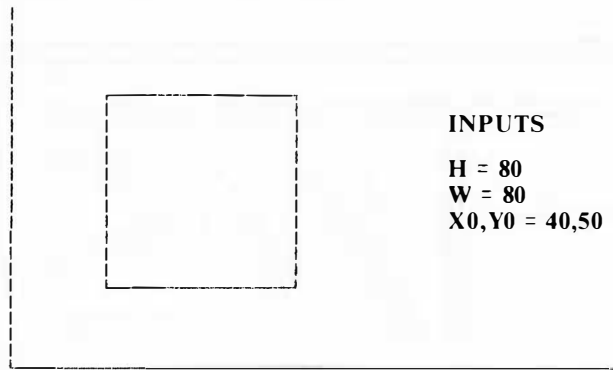

### ROTATING RECTANGLES

You may want to place a rectangle on the screen in a position that is not parallel to the axes of the coordinate system. A basic knowledge of trigonometry is helpful at this point. In this discussion and the modifications to our original program that will follow it, the sine and cosine trig functions are used. These functions are merely ratios of certain sides of a right triangle in relationship to a given angle of the triangle.

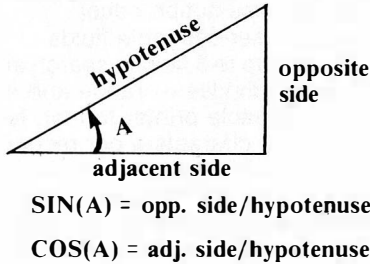

Suppose we start with a rectangle that is parallel to the X,Y axes and rotate the rectangle about the lower left corner by an angle A.

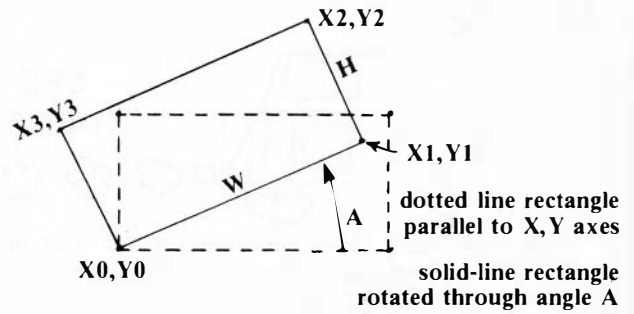

The lower left coordinates are the same as before, but the coordinates of the other corners have changed. First, consider the point X1,Y1.

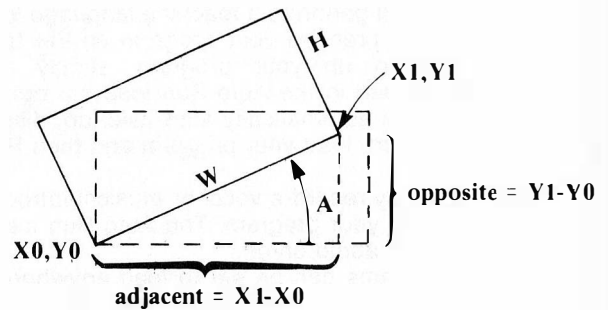

The sine and cosine relationships become:

$$\text{SIN}(A) = \text{opp.} / \text{hyp.} = Y1 - Y0 / W$$

$$\text{COS}(A) = \text{adj.} / \text{hyp.} = X1 - X0 / W$$

Multiplying both sides of each equation by W gives:

$$W * \text{SIN}(A) = Y1 - Y0 \text{ and } W * \text{COS}(A) = X1 - X0$$

Adding Y0 to the SIN equation and X0 to the COS equation gives:

$$* Y1 = Y0 + W * \text{SIN}(A) \text{ and } X1 = X0 + W * \text{COS}(A)$$

Therefore the X,Y coordinates of the new point can be expressed in terms of the coordinates of the lower left corner, W, and a trigonometric function. The Color Computer can easily calculate these coordinates.

Now consider the next new corner (X2, Y2).

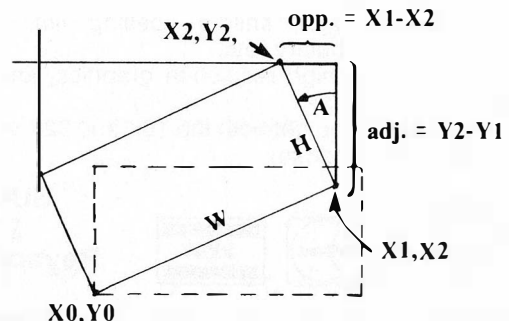

**TAKE THE GUESSWORK OUT OF**  
**STOCK & FUND**  
**INVESTING**

FUNDGRAF is a new computer program which not only graphs and analyzes funds or stocks, but also makes decisions on when to buy and sell. Use your TRS-80 Color Computer (TM Tandy Corp.) as a valuable investment tool.

- GRAPHS the progress of your funds or stocks
- SUPERIMPOSES for comparison:
  - a line of constant percent growth
  - a graph of any other fund
- CALCULATES over any given time span:
  - percent price change
  - the moving average
- INDICATES BUY and SELL signals

**Tape version compares** stocks or funds in groups of seven for up to 70 weeks.  
---\$49.95--

**Disk version compares** any 36 funds on one disk for up to 200 weeks.  
---\$69.95--

FUNDGRAF - A STOCK MARKET ANALYSIS PROGRAM FOR TRS-80 COLOR COMPUTER

TAPE - \$ 49.95  
DISK - \$ 69.95

TRS-80 COLOR COMPUTER - TM TANDY CORP.

-Sample data and detailed instructions furnished.  
 -Both versions require 16 K Extended Basic.  
 -For more information send S.A.S.E.  
 -For your FUNDGRAF program send the price indicated above plus \$2.00 handling to:

**PARSONS SOFTWARE**  
**118 WOODSHIRE DRIVE**  
**PARKERSBURG, WV 26101**



First,

$$\sin(A) = \frac{X1-X2}{H} \quad \cos(A) = \frac{Y2-Y1}{H} \quad \text{Then,}$$

$$H \cdot \sin(A) = X1-X2 \quad \text{and} \quad H \cdot \cos(A) = Y2-Y1$$

And finally,

$$* X2 = X1 - H \cdot \sin(A) \quad \text{and} \quad Y2 = Y1 + H \cdot \cos(A)$$

In a similar way, it can be shown that:

$$* X3 = X2 - W \cdot \cos(A) \quad \text{and} \quad Y3 = Y2 - W \cdot \sin(A)$$

By changing only four lines of DEFRECTSUB in our previous program, we can arrive at a program that will place the rectangle at any angle and at any location on the screen.

Change lines:

```
2050 X1=X0: Y1=Y0: X2=X0+W*cos(A): Y2=Y0-  
8*W*sin(A)
```

```
2070 X2=X1-H*sin(A): Y2=Y1+.8*H*cos(A)
```

```
2090 X2=X1-W*cos(A): Y2=Y1+.8*W*sin(A)
```

```
2110 X2=X0:Y2=Y0
```

Two lines are also added to the main program to input the angle of rotation in degrees and to convert the angle to radians. The SIN and COS functions in Color Basic and Extended Color Basic require angular units to be radians rather than degrees. If you wish, you may input the angles directly in radians at line 150 and omit line 160.

Add lines:

```
150 INPUT "ANGLE IN DEGREES":A
```

```
160 A = A/57.295779
```

The revised program follows. Use care in the placement and size of the rectangles that you draw. There are no provisions in the program that will insure that all points will be within the limits of the display. This is left as an exercise for you.

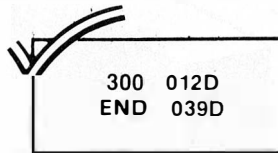

```
100 REM *** INPUT DATA ***  
110 CLS  
120 INPUT "HEIGHT";H  
130 INPUT "WIDTH";W  
140 INPUT "X,Y";X0,Y0  
150 INPUT "ANGLE IN DEGREES";A  
160 A = A/57.295779  
170 '  
200 REM *** SET SCREEN; DRAW AXE  
S ***  
210 PMODE 4,1  
220 PCLS1  
230 COLOR 0,1  
240 LINE(0,181)-(255,181),PSET  
250 LINE(0,0)-(0,181),PSET  
260 SCREEN 1,0  
270 GOSUB 2040  
290 IF INKEY$="" THEN 290 ELSE 1  
10  
300 '  
2000 REM *** DEFRECTSUB ***  
2010 REM REQUIRES X0,Y0 THE COOR  
DINATES
```

## \*\*\* SELECTED SOFTWARE \*\*\* FOR THE COLOR COMPUTER

All programs are in 16K machine language unless noted. Extended basic not required.

### MARK DATA PRODUCTS

- \*\* **SPACE RAIDERS** New Invader-type game. Super Hi-Res Graphics and Sound. You'll love it. \$24.95
- \* **ASTRO BLAST** Excellent space shooting game. Super Hi-Res Graphics and Sound. \$24.95
- \* **COLOR HAYWIRE** Classic arcade game, rated A+ by Color Computer magazines. \$24.95

### SPECTRAL ASSOCIATES

- \* **GALAX ATTAX** Protect your base by shooting alien fighter in formation. Excellent Graphics and Sound. \$21.95
- \*\* **SPACE RACE** Maneuver yourself in space but alien ships appear and must be destroyed. Hi-Res Graphics and Sound. \$21.95
- \* **PLANET INVASION** Excellent Defender-type game. Highest-Res Graphics and Sound. \$21.95
- \* **DEFENSE** Defend your spaceships from enemy laser beams. \$21.95
- \* **SPACE WAR** You must break through the enemy fighters and the defenses of Death Star. Super fast. \$21.95
- \*\* **SPACE INVADERS** Fast action Invader game. Excellent Graphics and Sound. \$21.95
- \* **GHOST GOBBLER** Highly rated Pac Man-type game. 16 skill levels and lots of action. \$19.95
- \* **KEYS OF THE WIZARD** Super adventure game! Great sound! You never play the same twice. \$19.95
- \* **MADNESS AND THE MINOTAUR** Challenging adventure game, different everytime. \$19.95

### TOM MIX SOFTWARE

- \* **DONKEY KING** (32K) Just Outstanding! \$24.95
- \* **KATERPILLAR** Excellent Centipede-type game. Highly rated by Color Computer magazines! \$24.95
- \* **WAR KINGS** Battle to save your castle and king. Hi-Res Graphics with Outstanding Sound. \$19.95
- \* **PROTECTORS** (32K) Excellent Graphics and Sound. \$24.95

### MED SYSTEMS

- INVADER'S REVENGE** You are the last survived space invader. You must revenge! \$19.95
- PHANTOM SLAYER** Enter the deadly catacombs and destroy the phantoms. 3-D Graphics. \$19.95

### INTELLECTRONICS

- \* **DUNKEY MUNKEY** (32K) Absolutely excellent Donkey Kong-type game. You'll love it! \$21.95
- STAR FIRE** One of the best Defender-type game. Hi-Res Graphics and Sound. \$19.95

### INTRACOLOR

- \*\* **COLORPEDE** Just like the arcade. \$29.95

### THE PROGRAMMER'S GUILD

- \*\* **PACDROIDS** The most challenging Pac Man-type. Super Hi-Res Graphics and Sound. \$19.95

### UPGRADE YOUR COLOR COMPUTER!

Complete solderless kits with easy-to-follow instructions.

4K-16K \$15.95  
16K-32K \$29.95

\*Requires Joystick \*\*Joystick Optional

Write for complete listings  
Buy 2 items and get 10% off  
We pay postage on all orders  
Send check or money order to:

**SELECTED SOFTWARE**  
P.O. Box 32228, Fridley, MN 55421  
(MN Residents add 6% sales tax.)

```

2020 REM OF ONE CORNER AND USE
S
2030 REM DRAWSUB1 AND DRAWSUB2
2040 GOSUB 3030 'DRAW AXES
2050 X1=X0:Y1=Y0:X2=X0+W*COS(A):
Y2=Y0-.8*W*SIN(A) ←
2060 GOSUB 3540 'DRAW LINE
2070 X2=X1-H*SIN(A):Y2=Y1-.8*H*
COS(A) ←
2080 GOSUB 3540 changed
2090 X2=X1-W*COS(A):Y2=Y1+.8*W*
SIN(A) ←
2100 GOSUB 3540
2110 X2=X0:Y2=Y0 ←
2120 GOSUB 3540
2130 RETURN
2140 '
3000 REM *** DRAWSUB1 ***
3010 REM SETS LOWER LEFT CORNER
3020 REM OF RECTANGLE
3030 Y0=181-.8*Y0:PSET(X0,Y0)
3040 RETURN
3050 '
3500 REM *** DRAWSUB2 ***
3510 REM DRAWS LINE FROM X1,Y1
3520 REM TO X2,Y2 AND SETS
3530 REM X1 TO X2 AND Y1 TO Y2
3540 LINE(X1,Y1)-(X2,Y2),PSET
3550 X1=X2:Y1=Y2

```

### 3560 RETURN

#### TYPICAL ROTATED RECTANGLES

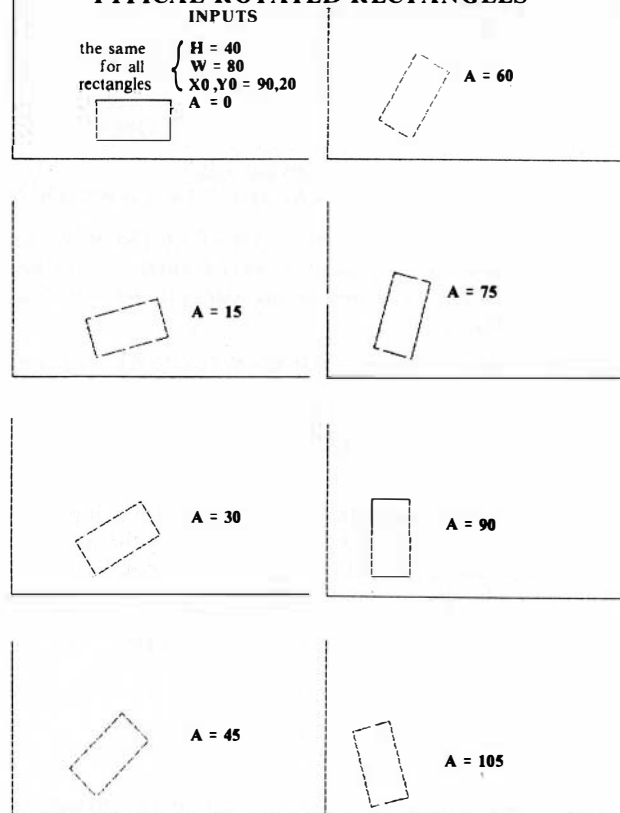

### The System 100 from Tandy.

TDP SYSTEM 100

- 10-1000 16K BASIC COLOR COMPUTER \$CALL
- 10-1010 16K BASIC/ EXTENDED BASIC \$CALL

\*\*\* SPECIAL!! 32/64K EXTENDED BASIC \*\*\*

INCLUDES: COGNITEC'S TELEWRITER 64  
Wordprocessor Program OR  
\$449.00 TOM MIX'S "DONKEY KING" Game!!!

\*\*\*\*\*

WE SELL AND SERVICE THE FOLLOWING PRODUCTS:

- TDP Electronics SYSTEM 100 COMPUTERS
- EPSON DOT MATRIX PRINTERS and COMPUTERS
- OKIDATA DOT MATRIX PRINTERS
- TRANSTAR MONITORS and LETTER-QUAL PRINTERS
- HAYES MICROCOMPUTER MODEMS
- FRANK HOGG LABORATORY
- SPECTRAL ASSOCIATES

DISCOUNT PRICES!!

- NOTE: TDP--100 System 100 PERSONAL COMPUTERS INCLUDE:
- o "BUST OUT" Game Cartridge
  - o Two Joysticks
  - o Easy to Read Tutorial Manuals
  - o TV/ Computer Interface Box
  - o RS-232 INTERFACE
  - o EXPANSIBILITY

**Emerald Computer Services**  
4401 219th S.W.  
Mountlake Terrace, WA 98043

\* VISA / MASTERCARD ACCEPTED \* COD \*  
OVERSEAS ORDERS WELCOME!!!  
ALLOW 2-3 WEEKS for PERSONAL CHECKS!

**206-778-9826**

LISTING FOR  
PARALLEL RECTANGLE

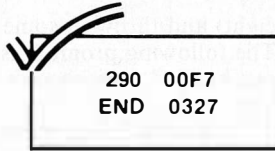

```

100 REM *** INPUT DATA ***
110 CLS
120 INPUT "HEIGHT";H
130 INPUT "WIDTH";W
140 INPUT "X,Y";X0,Y0
150 '
200 REM *** SET SCREEN; DRAW AXE
S ***
210 PMODE 4,1
220 PCLS1
230 COLOR 0,1
240 LINE(0,181)-(255,181),PSET
250 LINE(0,0)-(0,181),PSET
260 SCREEN 1,0
270 GOSUB 2040
290 IF INKEY#="" THEN 290 ELSE 1
10
300 '
2000 REM *** DEFRECTSUB ***
2010 REM REQUIRES X0,Y0 THE COOR
DINATES

```

```

2020 REM OF ONE CORNER AND USE
S
2030 REM DRAWSUB1 AND DRAWSUB2
2040 GOSUB 3030 'DRAW AXES
2050 X1=X0:Y1=Y0:X2=X0+W:Y2=Y1
2060 GOSUB 3540 'DRAW LINE
2070 Y2=Y0-.8*H
2080 GOSUB 3540
2090 X2=X0
2100 GOSUB 3540
2110 Y2=Y0
2120 GOSUB 3540
2130 RETURN
2140 '
3000 REM *** DRAWSUB1 ***
3010 REM SETS LOWER LEFT CORNER
3020 REM OF RECTANGLE
3030 Y0=181-.8*Y0: PSET(X0,Y0)
3040 RETURN
3050 '
3500 REM *** DRAWSUB2 ***
3510 REM DRAWS LINE FROM X1,Y1
3520 REM TO X2,Y2 AND SETS
3530 REM X1 TO X2 AND Y1 TO Y2
3540 LINE(X1,Y1)-(X2,Y2),PSET
3550 X1=X2: Y1=Y2
3560 RETURN

```

## PARALLEL PRINTER INTERFACE

FOR THE RADIO SHACK COLOR COMPUTER



- \* RUN ANY STANDARD PARALLEL PRINTER FROM THE COLOR COMPUTER SERIAL I/O PORT
- \* WORKS WITH : EPSON MX 70/80/100, NEC PC8023, CENTRONICS, C-itoh, OKIDATA, SMITH CORONA DAISY WHEEL, RADIO SHACK, OR ANY OTHER PRINTER WITH A STANDARD PARALLEL INPUT.
- \* SWITCH SELECTABLE BAUD RATES FROM 300 to 9600  
The Color Computer is capable of 9600 Baud -- Poke 150,1.  
Running at 9600 Baud greatly increases the printing speed of some printers.
- \* COMPLETE - ALL CABLES AND CONNECTORS INCLUDED
- \* PRICE : \$69 plus \$3 for shipping and handling. Michigan residents add 4% sales tax.

## BOTEK INSTRUMENTS

4949 HAMPSHIRE  
UTICA, MICHIGAN 48087  
313-739-2910

Dealer inquiries invited



## A Disjointed Tale For Assorted Wags

By T. & R. Delbourgo

Remember that old party game some of us called "Consequences?" Each of a number (greater than two) of people, seated round a table is provided with a slip of paper on which s/he must write a short story; for example:

- (1) Napoleon met (2) Josephine on (3) the Isle of Elba.
- (4) It was a desolate scene.
- (5) He said: It is lonely here.
- (6) She said: Don't despair!
- (7) The consequence was: He returned to the mainland.
- (8) The moral is: Never say die.

However, the whole point of the game is that at every stage of the story the papers are passed round the table. The result can be a hilarious jumble of stories with the oddest characters and consequences!

Your CoCo can add to the fun of the proceedings by offering a whole new series of permutations that are just not possible in the pencil and paper version. To give a little spice, the computer can assign a color code to every player (up to

eight) and throw in some sound effects for good measure. The following program is self-explanatory and we think it can be used to liven up a party when spirits are starting to flag.

Type in the listing below exactly as it appears (spaces, etc.) to achieve a perfect layout. In Line 16, as each tale is presented, you have the option of being able to print out any story which has particular appeal. Even though we have reserved 4500 characters in string space (Line 4), try to keep your sentences fairly short, say one line at most.

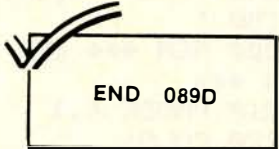

END 089D

### The Listing:

```

1 POKE359, 13: SCREEN0, 1
2 CLS0: POKE65495, 0: FORH=1024T015
35: POKEH, 63: NEXTH: POKE65494, 0: PR
INT@234, "CONSEQUENCES!";
3 PRINT@453, "BY T. AND R. DELBOU
RGO"; :PLAY"03L10CCL5EL10EEL5GL10
GGL504CP1"
4 CLEAR4500: CLS0: INPUT"enter THE
NUMBER OF PLAYERS (MAXIMUM
OF 8)"; N
5 DIMS$(N, 8)
6 FORP=1TON: GOSUB35: NEXTP
7 CLS0: PRINT"IF YOU ARE READY NO
W, I WILL MIX UP THE STORIES
AND THEIR CONSEQUENCES."
8 PRINT(N-1)"DIFFERENT MIXED-UP
SETS OF"N"STORIES FOLLOW:" :PRINT
@448, "PRESS ANY KEY TO CONTINUE"
9 I$=INKEY$: IF I$="" THEN9
10 FORU=0 TO N-2: FORP=1TON: CLS0
11 R=P-N*INT((P-1)/N): L=P+1+U-N*
INT((P+U)/N): PRINT@0, CHR$(127+16
*R)+S$(R, 1)+" MET "+CHR$(127+16*
L)+S$(L, 2): SOUND89, 3: SOUND108, 3
12 FORQ=3TO4: L=Q+P+(Q-1)*U-1-N*I
NT((Q+P+Q*U-U-2)/N): PRINTCHR$(12
7+L*16)+S$(L, Q): SOUND101+8*Q, 3: N
EXTQ: PRINT
13 K=P+4+4*U-N*INT((P+3+4*U)/N):
PRINTCHR$(K*16+127)+"HE SAID: "+
S$(K, 5): SOUND147, 3
14 K=P+5+5*U-N*INT((P+4+5*U)/N):
PRINTCHR$(16*K+127)+"SHE SAID: "
+S$(K, 6): PRINT: SOUND159, 3
15 FORQ=7TO8: L=Q+P+(Q-1)*U-1-N*I
NT((Q+P+Q*U-U-2)/N): PRINTCHR$(12
7+L*16)+S$(L, Q): SOUND128+6*Q, 3: N
EXTQ
16 PRINT@448, "PRESS ANY KEY TO C

```

### the Naked Gamer

If you think strip poker sounds like fun, read on. Actually, the name of this program package is not completely accurate. Only one player will end up completely undressed. These games are for the adventurous couple!!

The two games are good by themselves, but in the right company they can be terrific. The first is called **Strip Tails**, and is an arcade game played by two players simultaneously. You will need quick hands on the joystick and a quick grasp of the tactics to win, and if you lose, you could really lose your shirt. The other game is called **Sex**, and is something like Mastermind". Both the player and the computer choose a three letter word, and the player has to guess the computer's word before the computer can guess the player's.

At the end of each round of either game, the computer will instruct one of the players, by name, to remove a specific item of their clothing. Don't worry, there isn't anything obscene in these programs. (Remember, you are choosing a THREE letter word.) On the other hand, the RESULTS from playing could be interesting indeed, and the games are really good even if you elect to keep your clothes on. Available on TAPE for \$21.95, or on DISK for \$26.95. You will like these!!!

#### WE HAVE MORE — WRITE FOR LIST

Az. residents add 6% tax. Please add \$2.00 shipping and handling per program, and specify your choice of 1st class or UPS.

**Boudoir Software**  
Intelligent Adult Software

P. O. Box 17421 • Tucson, AZ 85731  
Dealer & Author Inquiries Invited





# RAINBOWfest

April 22-24, 1983

## CoCo's Very First Show!

CoCo has grown up and it's time for CoCo's very first show. Sponsored by *the Rainbow*, the premier magazine for the TRS-80 Color, TDP System-100 and Dragon-32 computers, RAINBOWfest will be the place to be this Spring.

Exhibits will abound. Information will flow. New products will be shown and introduced. Many of the "names" in the CoCo world will be in attendance. It all boils down to three days of fun, excitement and learning for everyone lucky enough to own a CoCo (or those who just wish they did)!

The place is the Regency-Hyatt Woodfield, located on the western outskirts of Greater Chicagoland, within easy access to highways and O'Hare International Airport.

The dates are April 22-24.

The times are 7-10 p.m. Friday; 9 a.m.—8 p.m. Saturday; and 10 a.m.—5 p.m. Sunday at the Grand Ballroom.

The cost is only \$7.50 for a three-day ticket in advance or \$11 for a three-day ticket at the door. One-day tickets are \$5. in advance or \$7.50 at the door.

A Saturday "let's make friends" breakfast is also planned. Cost of \$10 includes breakfast and a speaker—someone well known in the world of Color Computers.

Rooms are available at the Regency-Hyatt Woodfield for a special RAINBOWfest rate of \$43 per night, single or double occupancy.

Admission tickets, breakfast tickets and reservation cards for the hotel can be secured directly from *the Rainbow*. Mail the form below to *the Rainbow*, P.O. Box 209, Prospect, KY 40059. Advance sale tickets will be sent by return mail up until April 15. After that, they will be available at the door.

Oh yes...for the "others" who (perish the thought) don't get into CoCo like you do, Woodfield Shopping Center directly adjacent to RAINBOWfest is the world's largest enclosed shopping mall. And, you are only a short drive from downtown Chicago's museums, theatres, aquarium and shops.

RAINBOWfest has it all! Don't miss CoCo's very first show!

### PLUS . . .

*A Noted Nationally-Known Speaker Saturday Morning  
Seminars Saturday and Sunday on all aspects of CoCo  
BASIC classes for all*



YES, I'm coming to CoCo's very first show! Please send me:

\_\_\_\_\_ three-day tickets at \$\_\_\_\_\_ total \_\_\_\_\_

\_\_\_\_\_ one-day tickets at \$\_\_\_\_\_ total \_\_\_\_\_

\_\_\_\_\_ breakfast tickets at \$10 total \_\_\_\_\_

handling charge \$1.00

TOTAL ENCLOSED (U.S. FUNDS ONLY, PLEASE)\$\_\_\_\_\_

- Also send me a reservation card for the Hyatt-Regency Woodfield.

NAME \_\_\_\_\_

STREET & NUMBER \_\_\_\_\_

CITY & STATE \_\_\_\_\_

TELEPHONE \_\_\_\_\_ ZIP CODE \_\_\_\_\_

COMPANY \_\_\_\_\_

Advance Sale ends Thursday, April 21. Orders sent after April 15 will be refunds on tickets.

Make checks payable to:  
**the Rainbow**

MAIL TO:  
RAINBOWfest  
P.O. Box 209  
Prospect, KY 40059





# LEARN A SECOND LANGUAGE ON YOUR COLOR COMPUTER • NEW • EXCITING • EASY

*Creative Courseware using the latest technology and Professional Programming*

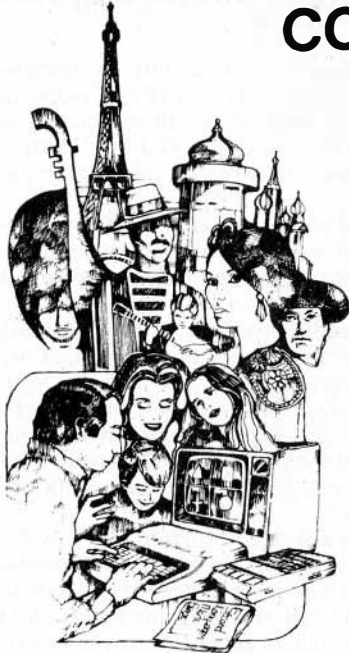

- Fulfill your educational objectives
- Have fun learning a new language
- Expand your children's horizons.
- Improve your job potential
- Young and old can learn
- Affordable, only pennies per hour.

- **SEE** — High quality visuals, not dotted graphics
- **HEAR** — High quality audio as spoken by natives
- **UNDERSTAND** — Through programmed instruction
- **RESPOND** — Branching, and looping insure learning.

## Our Lessons Teach You to HEAR and THINK in a Second Language

These lessons are for you if you:

- Think you can't learn
- Have had previous difficulties
- Want to start out right
- Want language success

## Lessons Now Available in Spanish, English and French

- Color Computer with 16K RAM and tape recorder required
- SLU-1: People, Persons & Family
- SLU-2: Stand, Walk & Run
- SLU-3: Smile, Eat & Talk
- SLU-4: House
- SLU-5: Open & Closed
- SLU-6: Furniture & Appliances
- SLU-7: Meals
- Vocabulary #1, 2 & 3: 200 words each

## Other Lessons and Languages Available Soon

## Special Values

### Special Value #1

SLU 1-3, VOCAB 1, and Lesson Control A **\$129.75** Value for only **\$99.95**.  
SV-1 (specify language desired)....\$99.95

### Special Value #2

SLU 1-7, VOCAB 1-3, and Lesson Control A **\$249.45** Value for only **\$199.95**.  
SV-2 (specify language desired)...\$199.95

### Demonstration Lesson (for the doubter)

DEMO-1 ..... \$9.95

### Individual Lessons:

(specify language desired)  
Second Language Usage (SLU) \$19.95  
Vocabulary (SL) ..... \$19.95

**Lesson Control:** (only one copy needed for all lessons and languages)

LC-CC ..... \$49.50

## HOW TO HEAR AND THINK IN A SECOND LANGUAGE

Skilled linguistics have developed our series of second language programs. The lessons utilize the power of programmed instruction wherein you are advanced to new material only after satisfactory learning has occurred at the current level. Our techniques teach you how to think in a language without initially using any printed text material. No mental translation to your native language is required. You learn as a child does, hearing and speaking before reading. The computer both tutors and keeps track of progress as it moves you forward (or backward when review is necessary). AUDIO plus VISUALS plus INTERACTIVE RESPONSE establish the learning process, and literally THOUSANDS of visuals help seal-in the sound patterns of your new language.

All of our lessons are interactive and user friendly; yet, you are unaware of the complex course structure involved. For example: Lesson SLU-1 uses the theme of PEOPLE, PERSONS & FAMILY to teach the use of nouns to name things, to classify them into categories, and to identify members of a group. Sentence structure is developed using the verb 'be' and its relationship to nouns and adverbs, including plural forms and inversions. Noun structure using definite and indefinite articles, and regular and irregular plural forms is also presented. The other lessons are similarly designed. In addition, each VOCABULARY LESSON presents approximately 200 visuals and 200 words that are integrated into the learning process.

While the foregoing might seem complex, and it is, IT IS ALSO THE REASON OUR COURSEWARE CAN TEACH LANGUAGES. If you have tried 'game' or 'tape' language programs you know that they are ineffective. Our programs can teach you a language because we have successfully combined expert authoring of programmed courseware with **audio & visuals & response & branching** into a powerful tutorial package.

### DEALER INQUIRIES ACCEPTED

We have a broad range of Audio Visual Computer Aided Instruction under development. Some users of our courseware might include Day Care Centers, Schools (public and private), institutions in various categories, individuals and language tutors.

### ABSOLUTELY NO RISK

You may examine your order for 15 days. If you decide not to take advantage of the lesson(s) simply return in good condition for a full refund or cancellation of credit card charges.

### \*WE PAY UPS IN USA

(street address required for UPS)  
\*Add \$2.00 if US Mail desired.

\*Add 15% for foreign. APO & FPO (Remit in US Funds)

\*Virginia Orders add 4% sales tax  
\*Mail credit card orders please include all card information

### WE ACCEPT

- VISA and MASTER CARD
- Money Orders
- Certified Checks

- Other Checks (must clear before shipment)

FREE ORDER LINE  
1-800-368-6300

\*\*\*  
FOR VIRGINIA ORDERS AND OTHER CALLS:  
1-804-463-6300

\*\*\*  
BASIC PROGRAMS, INC.  
236 Mustang Trail, #102  
Virginia Beach, VA 23452

## COLOR COMPUTER SOFTWARE

### ★ UNIVERSAL PROGRAM 1 (UP-1) ★

Known as the Program Stacker, UP-1 allows several programs to be loaded until the memory is filled. Quickly jump from one program to another or compose new programs while retaining the old ones. Programs are included for patching damaged programs. Allows data or machine language programs to be stored and retrieved from a cassette. Programs are included for writing values or characters to memory and displaying memory contents. Blocks of memory can be relocated. UP-1 can be used as a Word Processor by allowing text to be stored in memory and printed on the screen or an external printer. UP-1 Cassette \$14.95

### ★ DISSASSEMBLER-ASSEMBLER ★

Using English mnemonics and Decimal Locations, DISASM is an easy way to learn to assemble machine language programs or subroutines. Subroutines can be used with Basic programs and can be called by either USR or EXEC commands. For CC compatibility, all locations are given in decimal values, eliminating the confusion associated with using HEX. All commands are menu oriented and the user provides the particulars for the commands without having to remember command formats. The Disassembler can be used to analyze machine language programs as well as the Basic and Extended Basic CC ROMs. Example programs are included. Cassette \$19.95

### ★ DYNAMIC WORD PROCESSOR (DYWORD) ★

DYWORD is designed to handle all the word processing requirements of the Color Computer. It allows the creation of separate files for recipes, term papers, addresses, invoices, etc. Printer controls and graphic characters can be easily entered with the text. A full screen editor is included with up/down and left/right cursor position controls. The whole screen is changed as characters are added or deleted to five a realtime display. New characters can be written over old ones and, at any time, printer or graphic control values can be entered. DYWORD's files consist of Basic remark statements and can be loaded, saved or modified like any other Basic program. Fast machine language subroutines allow a printer to print text at its fastest speed and control the realtime screen display. DYWORD also allows numbers to be processed. For example, the costs of items can be entered in text in DYWORD and the program will convert these characters to numbers. Special characters such as CHR\$, PRINT #, or A\$(N) are not required. The Basic Control Program allows flexibility in processing text between any two statement numbers and in any order. Thus, it is easy to write the same letter addressed to different people. If you need a truly flexible word processor at a reasonable price then DYWORD is for you. Cassette \$24.95.

### EXTENDED BASIC IS NOT REQUIRED FOR PROGRAMS

#### ★ Put Your Programs On A PROM Pack ★

Send us a PROM PACK and your Basic or ML programs in a cassette and we will put your program in the pack. We add a sprocket and switch to select the original or your program. Total cost is \$39.95 for 4K or \$49.95 for 8K. We furnish and program the chips so the pack is ready for operation with your programs when we return it to you. Additional programmed chips are \$20 for 4K and \$30 for 8K. We will reprogram the chips for \$10. These programs are immediately available on power-up and are not lost with power failures or programming mistakes. Impress your friends with your permanent programs.

Checks, VISA, MC Cards

Add \$1 shipping

### DYNAMIC ELECTRONICS

P.O. Box 896

(205) 773-2758

Hartselle, AL 35640

Software Review...

## CoCo-Jot

### A Thinking Person's Hangman

Computer Island has come up with an interesting version of the spelling game "Hangman." It's called *CoCo-Jot*. Can you figure out the hidden word (either three, four, or five letters—your choice) within 10 tries? You start with 100 points and lose 10 for each try down to your 10th try and zero points.

Since Computer Island is aiming at educational software I wanted to try *CoCo-Jot* with my children, not only as a teacher in a classroom setting, but as a parent might use this program at home.

The well-done introduction of *CoCo-Jot* builds excitement. However, the game is not as exciting. *CoCo-Jot* requires an understanding that would take a teacher several rounds to explain. The directions are too complicated for young students alone to figure out. My children (first, fourth and sixth grade students) were able to handle it on their own after some coaching by me. My fourth grader finally said, "Oh! It's like Hangman."

The game lets you type a word and then tells you how many letters you got right. An alphabet list then lets you eliminate letters you feel you do not need. Then you switch to a "scratch pad" where you can play with the letters and try various combinations. My children, on their own, turned off the volume control as they did not like the constant "beep" of the scratch pad. By a process of elimination, you keep on guessing words until either you get it right or you get to the 10th try and the computer tells you the hidden word.

My first grader constantly referred to the word list looking for words that had, or did not have, the proper letters. This process will provide her with letter and word recognition. But it requires one-on-one help with a great deal of patience. She exclaimed "Thank goodness!" (positive) when she got two letters correct on a three letter word. She finally did get the word correct and she played two more games on her own.

My fourth and sixth graders felt that the game was difficult, but both said that they liked it and wanted to continue playing.

There are some changes that I feel would help the game. First, the lead instructions include a question for how much "time" you want. This is misleading as the game is not timed. The question is to randomize the word list. It would be better to have said "pick a number from 001 to 9999." Second, I found the sound in the "scratch area" annoying. It should be eliminated, I feel. Also, my first grader, when looking at the screen for choosing the word, counted five periods (.....?) for a three letter word and was confused.

From my point of view, as a teacher and parent, I feel that *CoCo-Jot* has potential to develop word and letter recognition with students. The game comes with a word list (but must be printed larger for school use). A fine feature is that the program can be modified with your own words and therefore can be tailored to your needs. The game might be more interesting if it were programmed in specific subject areas (i.e., presidents, countries, math terms). Above all, the game requires the most coveted of all educational goals—patience and thought, and to have an adult sit down and develop a working relationship with their student or child. Well, have you spelled "hug" with your child today?

(Computer Island, Dept. R., 227 Hampton Green, Staten Island, NY 10312, \$11.95, 16K)

—Michael F. Garozzo

# The PROFESSIONAL Keyboard

A direct plug-in replacement for your Color Computer.

- Simple Installation
- Standard Layout
- Electric Quality

**\$ 89.95**

Made by MACROTRON  
Call for TDP and  
F Color models.

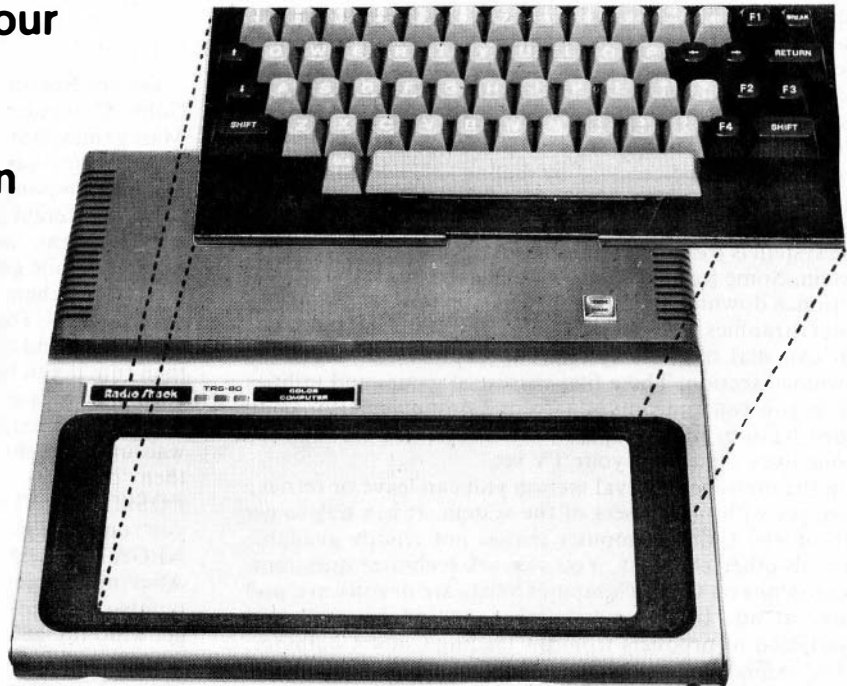

## SPECTRUM SWITCHER

by TJN SYSTEMS



**\$ 99.95**

Have your Disk and Cartridge too!  
Transforms a Color Computer into a dual slot  
system. Comes with extender cable.

---

## SPECTRUM PROJECTS

93-15 86th DRIVE WOODHAVEN, NY 11421  
212-441-2807

all orders plus \$2 S/H, N.Y. residents add sales tax



## Ghostmania Puts You In This Fascinating Game

Now that you know more about the hardware and software which is involved, you may ask, what else can I access besides large data bases which charge for the use of their systems? The answer is a growing phenomenon called the Bulletin Board Service. These are mushrooming all over the United States. What is a Bulletin Board Service you ask? A Bulletin Board Service, or BBS for short, consists of an individual with a personal computer and an auto-answer modem set up to have outside callers access their computer. (Yes, your own mini CompuServe!) Aside from the auto answer modem, one needs special BBS Software to run the system. For example, Spectrum Projects owns and operates two BBS's which totally support the Color Computer. The first system can be accessed by dialing (212) 441-3755. It is operated and run on a Model III with four double-headed disk drives. It has a disk storage capacity of 2.6 megabytes. The system is *free* and *no passwords* are needed to access the system. Some features of the system are a message retrieval section, a downloading section, a merchandise section and a Color Graphics section. Using a Smart Terminal Program, you can dial into the system and capture files from the download section. These files consist of games and utilities which you can run on your Color Computer. Also, as an added feature, color graphics can be accessed through the phone lines right onto your TV set.

In the message retrieval section you can leave or retrieve messages with other users of the system. It is a way to get info on the Color Computer that is not readily available through other channels. You can ask technical questions, get opinions on Color Computer hardware or software, and place an ad. In the merchandise section is a list and description of products from the leading Color Computer.

The second BBS which is operated by Spectrum Projects can be accessed by dialing (212) 441-3766. It will also be accessed if you call BBS#1 and it is being used. It is switched over from BBS#1 to BBS#2 via ringover. The second Bulletin Board is operated on a Color Computer.

There is one last thing you can do with your modem. Become a CoCo sysop! Sysop stands for system operator. The minimum requirements to run a BBS on a Color Computer are 64K of RAM, two disk drives, and an auto answer modem. And of course, BBS software!

Bulletin boards have proven to be very profitable investments, as yours truly can attest to. Just imagine sitting in front of your CoCo BBS and watching it being accessed by a complete stranger at any time of day or night from anywhere in the world! Make way for the Bulletin Board System—the wave of the future!

On no! Not another Pac-Man game. It sure seems that the Color Computer has been bombarded with enough Pac-Man games, but this is one of the more original ones.

This game has you in the game itself, not looking down, but in it, moving through walled corridors. *Ghostmania* is slightly different from the arcade version. First, there are no pellets to eat, and instead of energizers there are blue squares. While going through the maze the ghosts (there are about 30 of them) do not move until they see you, then they move at you. They gain points, which are displayed in the upper left hand corner, as they move, up to 255 points. You then run, if you have the chance, to a place where one of the blue squares is under you. The computer then displays how many more charges the pill has left, one to three. There you wait until the ghost rounds a corner and runs into you. You then get how many points he accumulated and one **POSITIVE ENCOUNTER**. The ghost is then eliminated. If you run into a ghost without being on a blue square you get a **NEGATIVE ENCOUNTER**, and the ghost disappears. After nine negative encounters the game ends. After a set number of positive encounters, determined by the level, you get a bonus game. The game has the fortunate option of stopping the action and looking down upon the maze, showing the ghosts, blue squares, you and the direction you are facing.

The game can be played for practice without ghosts or have the computer play. There are three skill levels, Beginner, Intermediate, and Competition. There are 10 speed options.

The maze is player designed. There is an 11-digit number displayed at the bottom before the game. The digits determine where passageways start and end and where turns go. For example, 9999999999 would be the easiest maze while 3333333333 would be the hardest. Three is recommended by the manual, as you would most likely be confined in a small area and unable to get to some places.

The graphics I must say are the best I have seen in a game of this sort. Fast machine code produces blue sky, green hallways, an orange floor and very believable white ghosts with blue eyes in a real-time environment. (For any of you *Chromasette* subscribers out there who have the game *Amazing*, the graphics are similar.) The program is written in machine language, and, as such, is very fast. If you buy the program, buy it for the graphics.

The game even has a monthly publication called the *Challenge List* of high scores and competition events. You receive a six-month subscription free when you mail in your registration form.

The 11-page manual is very good. It goes over every detail of the game. No joysticks are required for this game and only 16K. According to the manual, the disk version requires 32K and two disk drives. A game that requires two disk drives must really be something! The cassette version is well worth the price.

(Educational Arcade Systems, 5350 So. 3600W., Salt Lake City, UT 84118, \$29.95 for cassette)

—Jeff White



# A5 MAGAZINE

"OUR 15TH YEAR!"

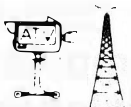

**Amateur Television Magazine**

MIKE STONE WB#QCD  
P.O. Box H, Lowden, Iowa 52255-0408

"For the specialized communication radio amateur"

**YES! SIGN ME UP FOR ... (12 ISSUES PER YEAR)**

	Surface U.S./Canada Mexico	Surface All Foreign	Airmail Central S. America	Airmail All Other Foreign	lowa residents add 3% sales tax.
1/2 year	\$ 10.00	\$ 13.00	\$ 20.00	\$ 23.00	
1 year	\$ 20.00	\$ 26.00	\$ 40.00	\$ 46.00	
2 year	\$ 38.00	\$ 50.00	\$ 78.00	\$ 90.00	
3 year	\$ 56.00	\$ 74.00	\$ 116.00	\$ 134.00	
Life	\$400.00	\$520.00	\$800.00	\$920.00	

**TIME TO RENEW [ ]**

Please only U.S. currency foreign checks drawn on U.S. banks or money orders in U.S. funds!

of informative, interesting A-5 MAGAZINE ... my money is enclosed!

NAME \_\_\_\_\_ CALLSIGN \_\_\_\_\_

STREET \_\_\_\_\_

CITY \_\_\_\_\_ STATE \_\_\_\_\_ ZIP \_\_\_\_\_

NEW [ ] RENEWAL [ ] Start with the \_\_\_\_\_ issue (Back issues \$2.50 each postpaid)

# BASIC AID

**AT LAST!** Help for the BASIC programmer. **BASIC AID** is an indispensable addition to the Color Computer. It will save you valuable time and effort. If you write or modify BASIC programs, you need **BASIC AID**.

You get **43** Common BASIC commands available as single Control Key inputs. Greatly speeds up program entry.

A powerful feature is the ability to **redefine** any or all of the keys to your own specifications **PLUS** you get invaluable features such as a **MERGE** command, **Move Line** command and **Automatic Line Numbering**.

**MERGE**— Insert programs stored on cassette into your Basic program. You can even assign new line numbers to the program you read in. Great for creating your own tape library.

**MOVE**— Lets you move and renumber any part of your Basic program. GOTOS and GOSUBs are automatically changed.

**Redefine** any or all keys! Put in **your** most frequently used commands. Then save them to tape for use another time.



"An excellent program and fine utility."—  
—RAINBOW review,  
August, 1982, Page 27

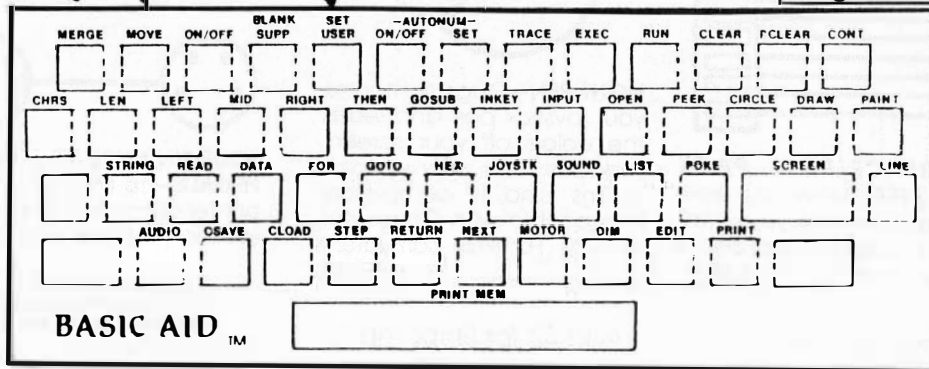

All of this in a convenient **ROM** cartridge which is available instantly on power-up. And, it uses almost none of your valuable memory! Comes with a convenient, easy to remove, **plastic** keyboard overlay.

"Dramatically improves programming ability"  
—80-U.S. Journal, October, 1982

"Basic Aid is a fantastic aid"  
—Color Computer News, October, 1982



**BASIC AID CARTRIDGE**

**\$34.95**

Add \$2 Shipping and Handling

**SPECTRUM PROJECTS**

93-15 86th DRIVE (212) 441-2807 (VOICE)  
WOODHAVEN, N.Y. 11421 (212) 441-3755 (DATA)



CHECK OUT OUR COLORBBS' AT (212) 441-3755 & 441-3766

# COLOR CABLES +

from SPECTRUM PROJECTS



The must CoCo book for 1983. Contains a myriad of peeks and pokes, ROM and RAM upgrades, machine language backups, printer potpourri and more! Make your computer do things it never did before.  
.....\$14.95

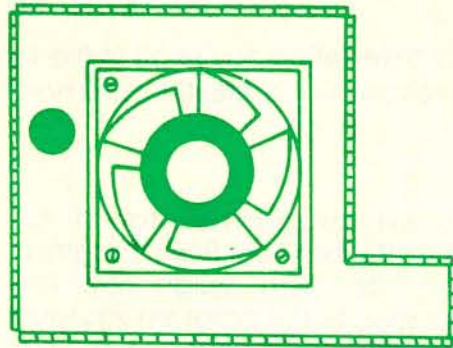

**COCO COOLER**—Internal cooling system. Prevent heat buildup inside your Color Computer. "CoCo Cooler keeps things cool."—Rainbow Review, Dec., 1982, Page 39. ....\$49.95

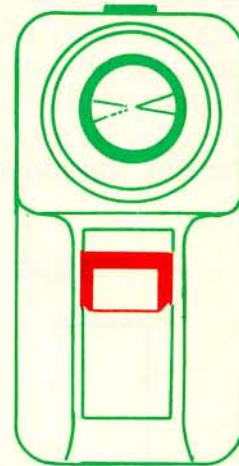

**THE SPECTRUM PADDLE**—Enjoy quicker response and higher game scores. Great for games with side-to-side action like Astro Blast, Space Invaders, Shooting Gallery and Clowns and Balloons. Includes "softtouch" fire button. "You have better control of the right to left movement than with any joystick we have seen so far"—Rainbow Review, Jan., 1983, Page 134. ....\$19.95

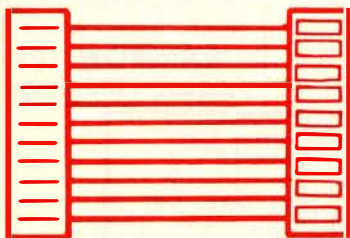

**DISK INTERFACE/ROM PACK EXTENDER — 3 FEET.** Move your disks and ROM packs where you want them. Gold plated contacts eliminate corrosion. ....\$29.95

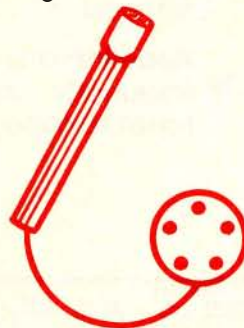

**LIGHT PEN**—Plugs right in to your joystick port and reads the colors off your screen. Includes four demo programs and is completely compatible with Computer Island's Fun-Pak software. ....\$19.95

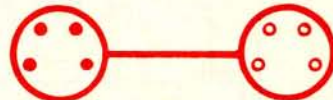

**FOUR-PIN MALE TO FOUR PIN FEMALE — 15 FEET.** Move your printer or modem to another location—easier use...\$14.95

**MORE CABLES . . .**

- Coaxial RF Adapter Cable and 8 Ft. RG59/u Coaxial Cable \_\_\_\_\_\$9.95\*
- Cassette Recorder Extension \_\_\_\_\_\$14.95
- SAM Saver (LED On/Off indicator)\$14.95
- Joystick Cable Extension \_\_\_\_\_\$14.95
- Disk Drive Extender \_\_\_\_\_\$14.95
- Serial Cable (specify printer) \_\_\_\_\_\$17.95
- Joystick "Y" Adapter \_\_\_\_\_\$19.95
- Two Drive Cable \_\_\_\_\_\$29.95
- Parallel Printer Cable \_\_\_\_\_\$34.95
- Four Drive Cable \_\_\_\_\_\$39.95
- Customized Cables \_\_\_\_\_CALL

\*Replaces gray audio cable to help reduce TV interference. Direct 75 ohm hookup.

Add \$2 for Shipping and Handling



**SPECTRUM PROJECTS**

93-15 86th DRIVE (212) 441-2807 (VOICE)  
WOODHAVEN, N.Y. 11421 (212) 441-3756 (DATA)

**COLOR COMPUTER EDITOR ASSEMBLER AND DEBUGGER**

"CCEAD is a high quality program and excellent value. CCEAD is a tool that no assembly language programmer can afford to be without."—RAINBOW Review, February, 1983 \$6.95

**THE STRIPPER**

Deletes REMarks, packs lines and removes blanks. "How much memory can you save? About 25% average."—RAINBOW Review, February, 1983 \$7.95

Call the Rainbow Connection At (212) 441-3755 & (212) 441-3766 for Rainbow Programs & Reviews

**DEALER/CLUB INQUIRIES WELCOME**

New York State Residents add appropriate taxes





Tired of plugging and unplugging devices from the RS232 port of your Color Computer? Make your life easier. Buy our RS232 expansion cable and connect two devices at the same time. Just right for printers, modems, etc. Anything that plugs into the Color Computer will plug into this high quality cable.

RS232 Cable \$20.00

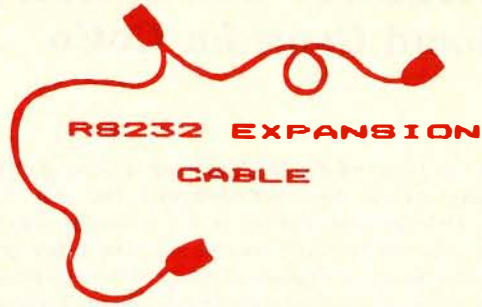

RS232 EXPANSION CABLE

COLORCOM/E BONUS! Order COLORCOM/E and get the RS232 cable for only \$15.00. Save \$5.00

32K RAM Button \_\_\_\_\_ \$2.99  
Nanos System Reference Card \_\_\_\_\_ \$3.99

**SPECTRUM PUTS THE SLAM ON RAM**

16K Chips \_\_\_\_\_ \$12.00/set  
64K Chips \_\_\_\_\_ \$49.95/set  
Basic ROM 1.1 \_\_\_\_\_ \$36.00  
Disk ROM \_\_\_\_\_ \$39.95  
6883 (SAM) Chip with heat sink \_\_\_\_\_ \$29.95  
6809E \_\_\_\_\_ \$29.95  
CoCo First Aid Kit (Be Prepared)  
(2 6821's, 6809E, & 6883) \_\_\_\_\_ \$69.95

Color Computer Tech Manual \_\_\_\_\_ \$7.95  
Epson Printer Interface (Serial I/O Port) \_\_\_\_\_ \$49.95  
Lowercase Kit \_\_\_\_\_ **ONLY** \$69.95  
12 Key Numeric Keypad \_\_\_\_\_ \$79.95  
Extended Basic ROM Kit \_\_\_\_\_ \$88.00  
64K "E"/"F"/TDP Board Upgrade \_\_\_\_\_ \$99.95\*  
RS Disk Interface (with manual) \_\_\_\_\_ \$179.95  
Epson MX-80 w/CoCo Interface \_\_\_\_\_ \$499.95  
\* FREE Return UPS Shipping

**STINGER IS HERE!** The ultimate maze game.  
Cassette \$24.95 Disk \$29.95 ROMPak \$34.95



# COLORCOM / E

## SMART TERMINAL PACKAGE

**WE DIDN'T WAIT for the competition to catch up with us! We've added even MORE features to COLORCOM/E, our superb Smart Terminal program for the Color Computer. Compare before you buy. NOBODY offers you more!**

- ★ Complete Upload and Download Support
- ★ Online Cassette/Disk Reads and Writes
- ★ 110, 300, 600, or 1200 Baud
- ★ Full or Half Duplex
- ★ Preenter Data Before Calling (Saves \$\$'s)
- ★ Offline and Online Scrolling
- ★ Automatic Capture of Files
- ★ Send All 127 ASCII Characters From Keyboard
- ★ Word Mode Eliminates split Words
- ★ 7 or 8 Data Bits (Including Graphics Support)
- ★ Efficient Data Storage S-t-r-e-t-c-h-e-s Memory
- ★ ROM Pack or Disk

**COLORCOM/E \$49.95**

**AND, our efficient storage and easy editing of received data makes printing to your printer offline a snap. Select any portion of the received data for printing. No need to print everything.**



Add \$2 for Shipping and Handling

**64K DISK UTILITY PACKAGE**

1. 40K—Tired of seeing 22823? A?MEM now returns 31015 with four pages for graphics!

2. Software Print Spooler—Tired of waiting for your printer? You can now output data to a RAM buffer at high speed and go back to programming while your data is being printed simultaneously on your printer! Works



**SPECTRUM PROJECTS**

93-15 88th DRIVE (212) 441-2807 (VOICE)  
WOODHAVEN, N.Y. 11421 (212) 441-3755 (DATA)

with printers that accept 1200 baud.

3. ROMCRACK—Now you can place your ROM PAC software on disk! ROMCRACK can make most ROM PAC software work on your disk. \$21.95

\*\*\* Available on cassette tape by itself for \$9.95. Half-price when ordered with Spectrum's 64K chips!

Call the Rainbow Connection At (212) 441-3755 & (212) 441-3766 for Rainbow Programs & Reviews

**DEALER/CLUB INQUIRIES WELCOME**  
New York State Residents add appropriate taxes

## CCTHELLO: Well-Executed Board Game for CoCo

*CCTHELLO* is a 16K Color Computer version of Othello (traditionally called Reversi) designed for the Color Computer. Othello is played on an 8 x 8 board, with two-color pieces (normally white on one side and black on the reverse). The object is to capture as many of your opponent's pieces as possible. Each player alternates placing his colored piece on the board in an attempt to outflank the other player. When a single piece or group of pieces have been outflanked, they are flipped to the opposite color. This results in some dramatic changes as the game progresses. Othello offers a range of strategic planning as well as immediate tactical conflict.

The game, marketed by Spectral Associates, is well designed for the Color Computer's graphic capabilities. It should appeal to the beginning and intermediate Othello player. Four modes of play are offered: three skill levels of competition against the CoCo, and an additional two-player option. This pits you against another human opponent while the computer assumes the role of score keeper and rule enforcer. *CCTHELLO* gives almost instant response due to its machine language programming. The joystick input is

smooth and allows you to concentrate on the logic of the game.

I have had experience playing Othello against several different computers using a variety of programs. I learned to play the game on a TRS-80 Model I using a program written in BASIC. It was very slow making moves, but offered a good challenge to my inexperienced play. I next graduated to a near master level program written by Dr. Peter Frey from Northwestern University. His program, called *OTHELLO V*, was almost unbeatable at its highest level of play. However, it required superhuman patience to complete a game that could take hours on the TRS-80 Model I. More recently, I have been playing Othello on a Lillith computer (a new scientific/engineering work station) programmed in a Pascal-like language called Modula-2. This version has very clever high resolution graphics as well as challenging play. It has the kinds of features that really improve your game, including options for suggesting moves when it has you in a tough situation.

Until *CCTHELLO* came along, my only experience playing Othello on the Color Computer was with a BASIC version. It had a poor display and played a relatively weak game. In contrast, *CCTHELLO* has a well-designed board display that makes good use of the Color Computer's high resolution color graphics capability. The game is programmed in machine language for fast response, and the levels of play are suited to both beginners and practiced players.

Joysticks are required for selecting game options and for moving the blinking cursor around the board to place game markers. You alternate first moves with the computer. A player always has light(yellow) markers while the computer takes the dark (blue) ones. The game also makes good use of sound to signal the moves. The score is continuously displayed on the screen in colors corresponding to the markers.

One feature of *CCTHELLO*, requiring some time to adjust, is its nearly instant response. A beginner might find it hard to visualize the consequences of his move before the computer gives its response. It would be helpful if a delay were built into the program so that a player could study the board before the computer makes its move. Most versions of Othello are slow enough that this usually isn't a problem.

Another problem with the game is in the two player mode. While playing another human opponent, it is sometimes hard to tell whose move it is. It would be helpful if the cursor would change colors to signal which player, light or dark, has the next move. This is particularly important when a player is blocked from making a move. In this case he must forfeit his turn. Without the cursor giving a cue, players must wiggle their joysticks to see who has control.

After playing many games with *CCTHELLO*, I have become familiar with its tactics at all three skill levels. I am sure that a beginner would find the first level challenging while learning the game. The third level will keep an experienced player alert at all times. It takes only one small mistake to turn the tables. Sometimes Othello can be that way. A very even scoring game can look like a complete rout when the final tally is made.

*CCTHELLO* is a well-executed board game for the Color Computer. It makes a fine addition to computer libraries, especially those with a tendency to become heavily populated with endless versions of space invaders and other reflex testing devices.

(Spectral Associates, 141 Harvard Avenue, Tacoma, WA 98466, cassette, \$14.95, disk, \$18.95)

—Stuart Hawkinson

### COCO-ACCOUNTANT

USE THE POWER OF YOUR 32K COCO TO MAKE INCOME TAX A BREEZE! KEEP TRACK OF HOUSEHOLD EXPENSES USING DATA FROM UP TO 450 CANCELED CHECKS. LOOK AT THESE FEATURES:

- \* LIST EXPENSES BY MONTH
- \* LIST EXPENSES BY ACCOUNT (YEAR OR MONTH)
- \* LIST EXPENSES BY PAYEE (YEAR OR MONTH)
- \* YEAR-TO-DATE SUMMARY BY ACCOUNT
- \* FLAGS & TOTALS DEDUCTIBLE EXPENSES
- \* COMPUTES SALES TAX YOU PAID ON PURCHASES
- \* UP TO 24 USER-DEFINABLE ACCOUNTS
- \* SORTS CHECKS BY DATE
- \* SAVE DATA ON TAPE (EASY DISK MOD.)
- \* LISTS TO SCREEN AND PRINTER

PAYS FOR ITSELF AT TAX TIME! REQUIRES 32K. \$15.95

### KOKOMATH!

KIDS BORED WITH EDUCATIONAL PROGRAMS? LET KOKO THE MATH CLOWN MAKE ARITHMETIC A JOY! GET 10 PROBLEMS RIGHT AND GIVE HIM A BATH! ADD, SUB., MULT., DIVIDE. THREE DIFFICULTY LEVELS. 16K EXT. \$8.95. KOKO WITH COMPUTER TIC-TAC-TOE \$11.95.

FEDERAL HILL SOFTWARE  
825 WILLIAM ST.  
BALTIMORE, MD. 21230

# THE DOUBLE STICK INTERFACE\*



Now you can  
hookup two Atari\* type  
joysticks to your Color Computer  
or TDP System-100 for only \$19.95

\$39.95 - The Interface with two Atari\* joysticks

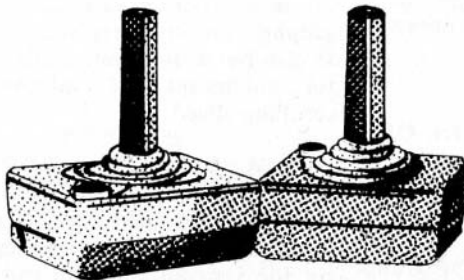

\* Interface made by WICO. Atari is a registered trademark of Atari, Inc.

**YES!**

PLEASE SEND:  
 INTERFACES... \$19.95  
 STICK/INTERFACE SETS... \$39.95  
 all orders plus \$2 shipping

NAME \_\_\_\_\_

ADDRESS \_\_\_\_\_

CITY, STATE, ZIP \_\_\_\_\_

N.Y. residents add sales tax

**SPECTRUM PROJECTS**

93-15 86th DRIVE  
 WOODHAVEN, NY 11421  
 212-441-2807



# RAINFLOW

**INTERNATIONALLY, THE COCO** movement is really beginning to catch on. Actually, it is partly the Color Computer and partly the Dragon-32 in England and Europe. And, we understand, there is still another look-alike coming from the Far East with the name Sampo.

An interesting aspect to the new Color Computers seems to be that they are doing very well in their "native" areas. We keep hearing that Dragon will come visiting the United States and Canada (and the same for the Sampo), but what is more interesting is that these computers seem to be carving out nice niches for themselves in their own areas.

Add to that the increasing CoCo influence overseas of Tandy itself, and you end up with a growing CoCo community that speaks many different languages. This is easily seen by a heavy increase in the number of copies of *the Rainbow* we are selling outside the United States and Canada. Those sales, which in the last six months were not inconsiderable, have now grown by 200 percent in the last couple of months! Well, maybe some day RAINBOWfest will have to have interpreters—but not of the hardware variety. Oh well, we'll all understand BASIC and Assembler, too.

\*\*\*\*\*

**HAVE YOU SEEN SANDS** of *Egypt*, the new graphics Adventure game from Radio Shack. This is not a review, obviously, but we were impressed by the game. Yet, it was not the program itself which impressed us as much as something else—a something that was also spotted by reader Charles Perrin of Huntsville, AL.

*Sands of Egypt* instructions tell you that if you have Disk Extended Basic 1.0 you type in *RUN "EGYPT"* to start the game. But, it adds, if you have version 1.1, you type in *DOS* first.

All this is by way of saying that there is a new DOS ROM for CoCo, and there are, we hear, a new Basic and Extended ROM as well. Its Basic 1.2, Extended 1.1.

The new Disk ROM appears to be a way to implement the OS-9 system you have seen us talk about. You can use this as an indirect call to the disk operating system, or something like that.

We hear that the new Basic ROM fixes up some of the machine language subroutines that sometimes caused problems. And, it is our understanding that the Extended ROM fixes the

problem we all had with the PCLEAR instruction.

Could that mean that CoCo is getting the final touches of its act together for a real change—or maybe a big brother sometime in the future. No, don't expect anything to come along in the next month or two along those lines, but we do hear reports of a new VDG chip that may be along soon.

Could the resolution be coming to something like 700 by 500 pixels? Could there be a 64-character screen display on the horizon? Is it possible to cram 4000 colors (that is not a misprint) onto one chip?

Before anyone gets worried about an outdated CoCo, we would like to point out that historically, Tandy has never obsoleted a computer. Even good ol' Model I software is compatible with Model III software. Or look at the Model II and the Model I6 (and now the 12). Software can, more or less, shift between like systems. Sometimes there are free or low cost upgrades. And, with Tandy's new author's assistance program, we see that practice continuing.

Yes, CoCo is here to stay. Why, even Wayne Green, who predicted the total demise of the Color Computer a year ago, is trying to get into the act.

\*\*\*\*\*

**NOT ONE MISTAKE**, but two to report to you. You may have inferred that the *Spectrum Light Pen* and the *Light Pen Fun-Pak* were both available from either Spectrum Projects (which markets the pen) and from Computer Island (which wrote the software). Not so, the whole package is available only from Computer Island (Dept. R, 227 Hampton Green, Staten Island, NY 10312) for \$34.95. The *Fun-Pak* sells separately for \$14.95. And, yes, it was an error in the Spectrum advertisement which showed the CoCo Cooler for \$19.95. Correct price is \$49.95. Both misprints are our fault, and we are sorry if they caused you problems.

\*\*\*\*\*

**NELSON SOFTWARE IS OUT** with one of the nicest-looking packages we've seen for their new *Super "Color" Library* series of programs. They have added to the *Super "Color" Writer II* and *Super "Color" Terminal* programs called *Calc*, *Database*, *Mailer*, *Speller* and *Disk-ZAP*. All come in handsome brown loose-leaf bindings with gold stamping. And, by the way, *Super "Color" Writer II* is into version 3.0

now, with high resolution display screens. This is also true for the new *Terminal* program.

The *Calc* program is a "what if?" spreadsheet; *Mailer* is a mail merge and correspondence program; *Database* is an electronic file and *Speller* is, of course, a spelling checker with 20,000 words.

\*\*\*\*\*

**SPECTRAL ASSOCIATES TALKS TO** you with a new high-resolution machine language game that incorporates words. *Android Attack* is available now and gives another dimension to CoCo that, we are sure, others will be using in the future.

\*\*\*\*\*

**CORES-64 FROM CER-Comp** is a new tape-based editor/assembler that can be run in any CoCo from 16 to 64K. A total of 59K of work space is available with the 64K version. It does not require a disk or FLEX to run the 64K version.

\*\*\*\*\*

**SPEAKING OF SPEECH**, Speech Systems has a couple of new products out that will let you make some noise. One of them is *The Voice*, which lets you produce all sorts of speech sounds. *The Stereo Composer* will give you a four-voice music synthesizer over seven octaves that produces music in stereo! Both of these utilities are available as ROM Packs.

\*\*\*\*\*

**SCHOOL SYSTEMS IN** Spring Valley, NY; New York City; Poca, WV; La Mesa, CA; San Antonio, TX; Buena Park, CA; Anacortes, WA; Elizabethtown, KY; New Castle, IN and Abilene, TX have been awarded Educational Grants Awards by Radio Shack's Educational Division. School systems can make application for another set of awards up until March 31.

\*\*\*\*\*

**BERTAMAX HAS A NEW** program called *Colortext* that allows use of a variety of character fonts and graphics on the screen simultaneously. It also has a non-destructive overwrite for animation and variable screen scrolling speed.

\*\*\*\*\*

**HOWARD SAMS BOOK** publishers has announced a new series of books dealing with microcomputers. The first two books in the series, written by Joe Giarrantano, will examine the evolution of computer technology and modern computer concepts. Two others will deal with BASIC.

**Spectrum Projects**  
Your TDP-100 Dealer  
**Trims Down Prices!**

**64K TDP-100  
with Ext/Basic**  
\$499.95

**Line Printer I  
(DMP-100)**  
\$299.95

**Color Graphic  
Printer**  
\$199.95

**DC Modem I  
Communications**  
\$129.95

**Color Cassette  
Recorder**  
\$49.95

**16K TDP-100  
with Ext/Basic**  
\$399.95

**CALL 212-441-2807**  
all orders plus \$2.00 S/H  
N.Y. residents add sales tax

**SPECTRUM PROJECTS**  
93-15 86th DRIVE  
WOODHAVEN, NY 11421

## Like To Live Dangerously? *Minefield's* A Blast

Those among us fortunate enough to have avoided actual combat will be able to enjoy *Minefield*, a game simply conceived, yet challenging enough for the most seasoned of computer war-game veterans.

The object, of course, is to cross an area that has been peppered with hidden mines by the enemy. There are 10 levels of difficulty, but, believe me, none of them is easy.

After you *CLOAD* the cassette, the computer requires several seconds setting up the mine field, sounding short beeps as each mine is placed. Those of you without joysticks will be glad to know that the game uses the arrow keys to negotiate the course.

You'll be even happier to know that you are provided with a mine detector that sounds once for each mine touching the invisible square that you occupy. It tests all four sides, including the corners, so there are eight possible locations. However, the mine detector doesn't tell you the exact positions of the mines. So, even with a warning, you are never out of danger. Step on a mine and you are blown to smithereens!

If you're lucky enough to make it through the mine field alive (I never have), your score is contingent upon how many moves are required, as well as the difficulty level. While any mention of mine fields usually brings to mind someone gingerly stepping along trying to avoid triggering the notorious and deadly "Bouncing Betty" or Claymore antipersonnel mines or maneuvering heavy equipment past antitank mines, the most destructive of all, the term *mine* dates back to the time when soldiers would actually mine tunnels underneath enemy trenches and forts, then pack them with gunpowder and *BOOM*. During the Civil War, the Union forces tunneled under the Confederate entrenchment at Petersburg, Virginia, and blew such a hole that the engagement is now known as the Battle of the Crater.

As you play *Minefield*, you are reminded of the terrors of war and should be able to empathize with those among us who have experienced the feeling of possible extinction with the next footstep. Melodramatic? Perhaps, but it is one of the things you experience as you enjoy the game.

(Valhalla Enterprises, P.O. Box 243, Sumner, WA 98930,  
\$4.95 on tape)

—Charles Springer

## Tower of Fear: Despite Death, A Fun Adventure

*Tower of Fear* is a moderately difficult word adventure. It has death (I got killed at least three different ways), treasures, and several surprises. This adventure takes place in Graylockland at the castle of the late Blackheart Firethrower. That is, if you can get into the castle, ha ha. Blackheart Firethrower's castle has been inhabited by wraiths and cyclopes for the past three hundred years. No one, Sir Adventurer, has ever returned with even one of Blackheart's valuable treasures.

With excellent assistance from my wife, I was able to find all the treasures in four or five hours of playing time. I found all the treasures by using imagination, courage, skill(?), magic, and luck. I found it certainly doesn't pay to go wandering aimlessly around in a maze of corridors. It seems the unfriendly cyclopes kill first and ask questions later.

*Tower of Fear* has a couple of nice features I really like. One is that about six seconds after the program starts loading a graphic title page is uncovered line by line. The other feature is that during play the screen uses reverse video. This makes a much more interesting and easy to read screen. The one- and two-word commands used in the game are not dissimilar from any other word adventure.

The game is written for 16K and is in machine code. I was somewhat disappointed in the documentation for the game. The single sheet of paper that came with the cassette provides the setting for the adventure, but gives no information on how to play the game. Therefore, I would not recommend this as a first adventure, but if you have had some experience with word adventures, then I'm sure you'll like this one. Another complaint I have with the documentation is it gives you instructions to *CLOAD* the tape, but since it is in machine code you have to *CLOADM* it.

One other problem I had was that I could not successfully save a game in progress. After making a couple of calls to Bob Little of The Programmers Guild I found out the problem. When saving a game you have to use eight characters for a file name or the program won't recognize your data file.

All in all, this is a fun adventure game. I recommend it.  
(The Programmer's Guild, P.O. Box 66, Peterboro, NH  
03548, \$19.95)

—Michael Hunt

### PEACOCK ENTERPRISES

NOW in NASHUA, NEW HAMPSHIRE

\*\*\*\*\* INTRODUCING CMAILIST 5.1 \*\*\*\*\*  
CMAILIST 5.1 is a disk based version of our famous CMAILIST Mini - DATA BASE program. CMAILIST 5.1 offers the features of 4.0 with substantial enhancements. Compatible with 16K, 32K, 1 or 2 drives. 500 RECORDS maybe stored per FILE. ADDED FEATURES now include DOUBLE or SINGLE line street address, and the ability to have a TITLE (President; Sales Rep. etc.) follow the last name. PLUS a host of features: Like SORTING by NAME, ZIP, or KEYWORD; printout LABELS or ENTIRE CONTENTS of your records; set up a TICKLER file; SEMI-AUTOMATIC generation of INVOICES makes billing a snap. All this makes CMAILIST 5.1 a must for HOME & BUSINESS applications. It includes our comprehensive manual, 1 year warranty, free upgrades, written in BASIC.

CMAILIST 5.1 is available now for immediate delivery. Join the 100s of discriminating and satisfied users.

\*\*\*\*\*

CMAILIST 4.0 \$15.95; 5.0 \$24.95; 5.1 \$29.95

UPDATES: 4.0 to 5.0 \$6.50; 4.0 to 5.1 \$10.00; 5.0 to 5.1 \$5.00

AND DON'T FORGET we have the LOWEST prices on ProWriter lineprinters!

CODs accepted (shipping added): Send SASE for FREE CATALOG

PEACOCK ENT. 194 CANNONGATE III ROAD NASHUA, NH 03063 603-880-8169





# LOSING BATTLES WITH A GLOOMSTICK?

"The feeling of this joystick is superb."  
—80 Micro, March 1983

PUT THE JOY BACK IN  
COLOR COMPUTING  
WITH A NEW.....

## SPECTRUM STICK

Dealer/Club Inquiries Invited

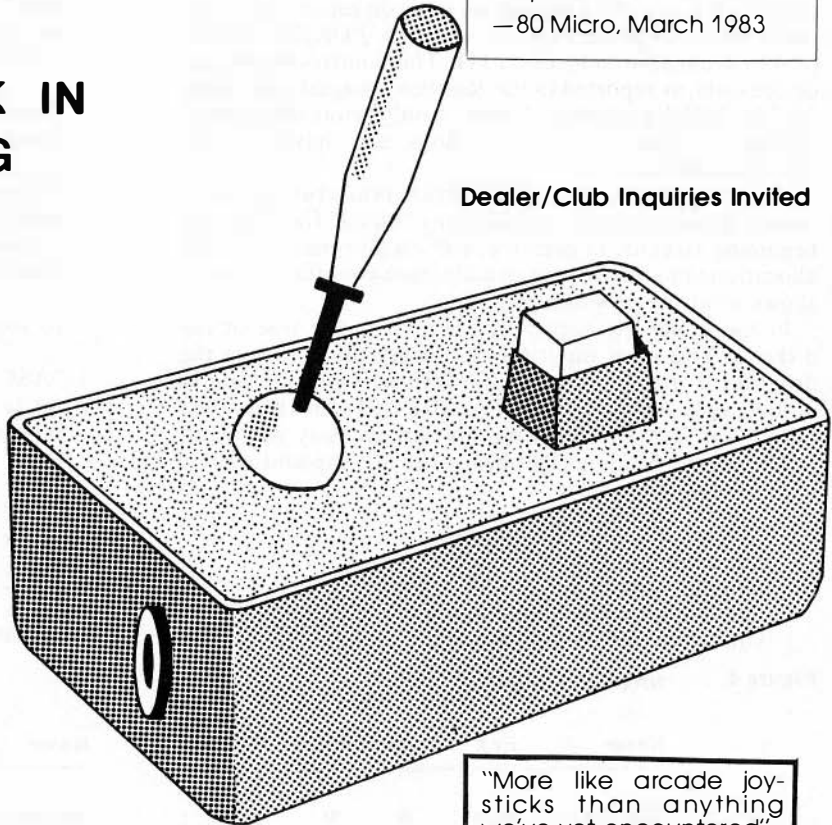

### Features include:

- Power on/off LED indicator
- Ball joint components for a true feel of control
- Extra long cables
- Sturdy construction
- Hair trigger response

"More like arcade joysticks than anything we've yet encountered"  
**Rainbow** review October 1982, Page 112

"Both the joystick and pushbutton should have a considerably longer life than the Radio Shack unit since they are made of higher quality components"—  
Creative Computing, Feb., 1983, Issue.

please send( ) SPECTRUM STICK(s) at  
\$39.95 each plus \$2.00 shipping to

name \_\_\_\_\_

address \_\_\_\_\_

city,state,zip \_\_\_\_\_

N.Y. Residents Add Appropriate Taxes

**SPECTRUM PROJECTS**  
93-15 86th DRIVE  
WOODHAVEN, N.Y. 11421





# Hard Copy Your Diskette Listings With Style

By Michael Plog

The basic idea of this program is to produce a printed copy of the directory listings of your diskettes. This task could be accomplished rather easily by *POKEing & HFE* (254 in decimal) into location III. This controls the output device code, as reported in *the Rainbow*, August 1982, page 29. The *POKE* procedure, however, only prints what would appear on the screen, and does not have a very "professional" look.

The program discussed in this article prints two directory listings across the page, includes any "killed" files, tells the beginning Granule of each file, and even prints out the file allocation table, so you can visually track your files. Figure 1 shows what the program produces.

In the upper-left corner of Figure 1 is the title of the diskette. You must input the title every time you run the program. I use the Line Printer VII, so I put the title in double wide letters by printing CHR\$(31), the title, then CHR\$(30). You can dress up this part any way you want.

The double heading right below the title explains what is to be found in the table.

"Name" refers to the name of the file, as recorded on the diskette. Any file name starting with a number sign (#) indicates the file has been killed, but not written over. (If

you wish, you can try to recover this file.) For example, note the first listing in the right column; it demonstrates a killed file.

"Ext" is the extension name listed on the diskette.

"Type" refers to the file type: 0 means a BASIC program; 1 means a BASIC data file; 2, a Machine Language Program; and 3 a Text Editor source file. (Refer to your Disk Owner's Manual.)

"ASC" refers to the storage mode of the file. A "B" indicates binary format; "A" is ASCII format.

Under the "GRANULE" heading, "NUM" is the number of Granules in the file. "ST" indicates the start, or beginning, Granule. (More on this later.)

The number of free granules is printed following the

Figure 1 RAINBOW SAMPLE DISK

Name	Ext	Type	ASC	GRANULE		Name	Ext	Type	ASC	GRANULE	
				ST	NUM					ST	NUM
AD-DICT	FEB	0	B	32	1	#-GONER	FEB	0	B	33	1
UTILITY	FEB	0	B	30	4	DATING	FEB	0	B	38	1
FRACTION	FEB	0	B	39	4	HANGMAN	FEB	0	B	26	3
HOMONYMS	FEB	0	B	25	1	INCOMTAX	FEB	0	A	43	5
MARQUEE	FEB	0	B	22	1	PREFIX	FEB	0	B	23	3
PRNTCHG	FEB	0	B	18	1	TAPECAT	FEB	2	B	19	1
TAX*HIST	FEB	0	B	48	2	THE WORD	FEB	0	B	16	3
VROOM	FEB	0	B	50	2	OUTPOST5	FEB	0	A	15	2
PLUGNPOW	FEB	0	B	52	1	BANNER	JAN	0	B	53	2
SIGN	JAN	0	B	13	2	AHHA	FEB	0	B	55	5
ACCOUNT	FEB	0	B	11	4	PRTDIR	MAR	0	B	34	1

19 FREE GRANULES

FILE ALLOCATION TABLE

```

          1          2          3          4          5          6
0123456789012345678901234567890123456789012345678901234567
22222212001010100011012011000100122222100010000102011010000122222222
55555595009091911199290299222932950555944494444940599595555955555555
55555545964880527483160087749418650555501254567890178456789455555555
    
```

COLOR COMPUTER/TDP-100\*  
**SUPER-PRO**  
REPLACEMENT KEYBOARD KIT



\*Computers produced after approximately October, 1982 require an additional keyboard plug adapter—please add \$4.98.

- Affordable Price—**Only \$69.95.**
- A **must have** for all serious computerists.
- Highest quality—U.S. made.
- Direct replacement—same key layout
- Professional appearance and operation.
- Fast, simple installation.
- Complete instructions included.
- In stock now.

AT YOUR FAVORITE DEALER OR DIRECT FROM

**MD**

**Mark Data Products**

24001 ALICIA PKWY., NO. 226, MISSION VIEJO, CA 92691 • (714) 768-1551

We pay shipping on all orders in the continental U.S. and Canada. Overseas add \$5.00 for shipping and handling. Foreign orders please remit U.S. funds. California residents, please add 6% sales tax. We accept MasterCard and VISA. We are always looking for quality machine language programs. Contact us for details.



listings of the files. This number may be misleading. If you have erased some files, the number of free granules may not reflect this.

At the bottom of Figure 1 is the File Allocation Table. The top row of numbers is a counter, for the sixty-eight granules of the diskette, numbered from 0 to 67. The bottom set of numbers indicates the contents of each byte of the File Allocation Table, in ASCII format (not Hex format). The numbers are to be read from top to bottom, in a single column. For example, byte 0 (the first one) of the File Allocation Table contains a "255." The meanings of the numbers contained in the File Allocation Table are:

255—The granule is not part of a file; it is a "free" granule.

0 through 67—The granule is used as part of a file. The number tells the next granule of the same file. For example, the number in byte 30 is "31." This means that granule 30 is part of a file and granule 31 is the next granule of the same file.

193 through 201—This granule is the last in a file. Subtract 192 from the number to learn how many sectors of this granule are part of the file. For example, a "195" means that three of the nine sectors are part of the file; six sectors are unused.

In order to make use of the File Allocation Table, refer

**START**



COMPUTER PROGRAMS  
TRS-80 MODEL 1/3 16K LEVEL II  
TRS-80 16K COLOR

---

#3      FROG RACE      #3  
DEMO PROGRAM FROG RACE COMES ON CASSETTE WITH A  
REFUND COUPON TO USE ON YOUR NEXT ORDER.  
FROG RACE CASSETTE \$3.                                  WITH CATALOG

---

DUO-PAKS ARE      \$10 EACH.

PAK NO.	PROGRAM SIDE 1	/	PROGRAM SIDE 2
DUO-PAK-1	GONE FISHING	/	CONCENTRATION
DUO-PAK-2	CRAPS	/	SLOT-MACHINE
DUO-PAK-3	STARSHIP	/	SHERLOCK HOLMES
DUO-PAK-4	TANK ATTACK	/	ASSOCIATION
DUO-PAK-5	NUMBER GUESS	/	DICE ROLL
DUO-PAK-6	IN-BETWEEN	/	SHELL GAME
DUO-PAK-7	SAFARI	/	STARSHIP-2
DUO-PAK-8	MORTAR BATTLE	/	PUZZLE
DUO-PAK-9	TEASERS	/	MOUSE
DUO-PAK-10	PT BOAT	/	TURTLE RACE
DUO-PAK-11	CHEK-CHESS	/	STARSHIP-3
DUO-PAK-12	THINK	/	LUCK & LOGIC
DUO-PAK-13	TREASURE ISLAND	/	RESCUE
DUO-PAK-500	DC-OHMS LAW	/	FLC-FRC
DUO-PAK-501	IC-TIMER-1	/	IC-TIMER 2

---

\*\*\*\*\*  
SYSTEM PROGRAMS    \$10 EACH

SU1      CASSETTE COPY      /      CASSETTE COPY  
\*\*\*\*\*  
ORDERS WILL BE SENT BY FIRST CLASS MAIL PPD.  
SORRY NO COD'S  
BE SURE TO SPECIFY WHICH COMPUTER YOU HAVE.  
B. ERICKSON                          P.O. BOX 11099  
CHICAGO, IL.                          60611

back to the numbers listed under GRANULE, in the ST column. This number shows the first granule of each file. Now, look at the number in that corresponding byte of the File Allocation Table. For example, the first program listed in Figure 1 is *AD-DICT*. The program begins on granule 32, and uses one granule of the diskette. In the File Allocation Table, byte 32 contains a "196." That means that four of the nine sectors are used for *AD-DICT*. *Hangman* starts in granule 26. The second granule of the file is 27 (this is found from the file allocation table entry for byte 26). The last granule of the file is 24, and the 198 means that six sectors are used and the remaining three are unused.

The File Allocation Table, as printed in Figure 1, allows you to visually track all the files (programs and data) on the diskette.

The Disk Owner's Manual gives some explanation of the File Allocation Table, and the reader is encouraged to examine the manual.

It is possible, of course, to print (to the screen or paper) each byte of any file contained on your diskette. That, however, is a subject for a future article. (Or for your experimentation.)

```

10 'PRINT DIRECTORY PROGRAM
20 '*****
30 '*                BY                *
40 '*                *                *
50 '*    MICHAEL PLOG    *                *
60 '*                *                *
70 '*****
  
```

Get ready to start, set up variables, print headings, read in file allocation table.

```

100 PCLEAR1:PMODE0
110 CLEAR 2000
120 DIM P$(2,6),Q$(68,3)
130 U$="%          % % %          % % % %
    % % % %"
  
```

(Guide for spacing of U\$; used in a PRINTUSING)

```

140 CLS
150 INPUT"NAME OF DISKETTE";X$
160 PRINT#-2,X$
170 PRINT#-2:PRINT#-2
180 PRINT#-2,TAB(27)"GRANULE";TAB(66)"GRANULE"
190 PRINT#-2,"Name          Ext Typ
   e  ASC  ST  NUM";TAB(39)"Name
     Ext Type ASC  ST  NUM"
200 PRINT#-2,STRING$(34,45);TAB(39)STRING$(34,45)
210 PRINT#-2
220 DSKI$0,17,2,F$,X$
  
```

Read in the directory listings, on track 17, sectors 3 through 11.

```

300 FOR Z=3 TO 11
310 DSKI$0,17,Z,A$,B$
320 X$=A$:GOSUB 400
330 X$=B$:GOSUB 400
340 NEXT Z
  
```



# DSL COMPUTER PRODUCTS

P.O. BOX 1113 — DEARBORN, MI 48121 — (313) 582-8930

ALWAYS LOOKING FOR GREAT COLOR COMPUTER SOFTWARE  
ADD \$1 SHIPPING AND HANDLING — MICHIGAN RESIDENTS ADD 4%



## EDUCATIONAL SOFTWARE

**SPELLER** \$16.95 Basic Voice tape program created by user. Self-explanatory instructions included.

**GEO-STUDIES** \$9.95 ea. USA, Europe, Canada & Australia

## UTILITIES

**Copy Cat ML** \$19.95 tape backup program

**Disassembler 6809** 16K Tape Based for Screen or Printer \$14.95 SSM

**Color DFT ML** \$19.95 Makes modem communication a breeze.

## ARCADE FUN

**Packmaze ML** \$16.95 Game interrupt and continuation feature

**Bug Chase ML** \$15.55 One or two player or robot bug against turtle.

## SPECIALTY

**Caligrapher Disk** only \$14.95 each or \$18.95. Two print fonts available, Old English and Chancery. Designed exclusively for Line Printer VII.

**Color Bonanza** \$49.95 50-program package includes business, utilities, as well as arcade fun. Less than \$1.00 per program!!

## **“THE GENERAL”™ HAS ARRIVED**

Get your books organized fast and effectively. Capable of handling 100 accounts and over 500 transactions on the 32K Color Computer. The following reports are generated on screen (printer optional)

1. Transaction List,
2. Chart of Accounts,
3. Ledger Account Activity Listing, and
4. Balance Sheet.

All this for **\$39.95** tape

## **NEW**

### **32/64K Grand Slam**

Solderless Kit. Must have version E or F Board and 1 1/2 Rom (exec 41175) only \$75.00. Please include \$10.00 Tool Deposit REFUNDABLE

FOR ALL BOARDS

## **RAM SLAM**

— Solderless Kit —

16-32K

\$49.95

15 Minute Installation  
One Year Warranty

“The Easy Way To More K”

## **MORE SOFTWARE NOW AVAILABLE**

**TOM MIX'S** Donkey King - 32K \$24.95  
 War Kings - 16K \$19.95  
 Word Drill - 16K \$19.95  
 Math Drill - 16K \$19.95  
 Mail List - 16K \$19.95  
 Moon Lander - 16K \$15.95  
 Dancin' Devil - 16K \$14.95

**MARK DATA-** Calixto Island — Black Sanctum 16K Machine Language \$19.95 ea. Cave Hunter — Astro Blast — Haywire 16K Machine Language \$24.95 ea.

**CHROMATIC SOFTWARE CO.** — The Spider 16K Machine Language Joystick Controlled \$19.95.

## HARDWARE

**RS-223 Switcher** 2 or 3 plug model available.

Stop straining the connectors.

2-plug model  
\$29.95

3-plug model  
\$39.95

**NANOS SYSTEMS** Cards for the color computer. \$4.95 ea.

## LITERATURE

**Assembly Language Graphics** \$14.95

**Basic Computer Programming for Kids** \$11.95

**The Computer Coloring Book** \$6.95

**TRS-80 Color Computer Graphics** \$14.95

**TRS-80 Programs & Applications for the Color Computer** \$14.95

**Programming in Basic for personal computers** \$9.95

**Income from your home computer** \$12.95

350 GOTO 700

Print the directory listings, two across.

```

400 FOR J=1 TO 128 STEP 64
410 FOR R=1 TO 2
420 Y=(R-1)*32
430 P$(R,1)=MID$(X$,J+Y,8)
440 IF LEFT$(P$(R,1),1)=CHR$(255) THEN 700
450 IF LEFT$(P$(R,1),1) = CHR$(0) THEN P$(R,1) = CHR$(35) + RIGHT$(P$(R,1),7)
460 P$(R,2) = MID$(X$,J+Y+8,3)
470 P$(R,3) = STR$(ASC(MID$(X$,J+Y+11)))
480 X = ASC(MID$(X$,J+Y+12,1))
490 IF X<>0 THEN P$(R,4)="A" ELSE P$(R,4)="B"
500 X = ASC(MID$(X$,J+Y+13,1))
510 P$(R,5)=STR$(X)
520 GOSUB 600
530 PRINT#-2,USINGU$; P$(R,1); P$(R,2); P$(R,3); P$(R,4); P$(R,5); P$(R,6);
540 IF R=1 THEN PRINT#-2,TAB(39); ELSE PRINT#-2
550 NEXT R
560 NEXT J
570 RETURN

```

Calculate the number of granules in each file.

```

600 G=0
610 G=G+1
620 B = ASC(MID$(F$,X+1,1))
630 IF B<70 THEN X=B:GOTO 610
640 P$(R,6)=STR$(G)
650 RETURN

```

Print the free granules of the diskette and the heading for the file allocation table.

```

700 PRINT#-2:PRINT#-2
710 PRINT#-2,FREE(0)"FREE GRANULES"
720 PRINT#-2:PRINT#-2
730 PRINT#-2,"FILE ALLOCATION TABLE"
740 PRINT#-2

```

<b>80C VOICE SYNTHESIS !!!</b>	
<p>BUILD YOUR OWN VOTRAX SC-01 SPEECH MODULE THAT PLUGS INTO THE SERIAL PORT. ENJOY THE FUN THAT COMES WITH BEING ABLE TO PROGRAM YOUR SYSTEM TO SAY ANY TEXT YOU WISH. USE IT TO ENHANCE GAMES, AS A TEACHING AID, OR TO HELP A DISABLED FRIEND. NO SPECIAL TOOLS REQUIRED. SIMPLE STEP BY STEP INSTRUCTIONS USING EASY TO OBTAIN RADIO SHACK STOCK PARTS (Except the VOTRAX chip, for which I provide a supplier's list). COMPLETE INSTRUCTIONS, INCLUDING SAMPLE PROGRAMS. \$5.00</p> <p style="text-align: center;">* OR *</p>	
<p>CUSTOM MADE PRINTED CIRCUIT BOARD. REDUCES WIRING TO A MINIMUM. INCLUDING SAMPLE PROGRAMS AND INSTRUCTIONS. \$15.00 PLUS \$1.00 POSTAGE</p> <p style="text-align: right;">Manitoba residents include 5% sales tax</p>	<p>SEND CHEQUE OR MONEY ORDER TO: B.T.PEARCE 743 MULVEY AVE. WINNIPEG MANITOBA CANADA R3M 1G4</p>

```

750 FOR I=1 TO 6
760 PRINT#-2,TAB(10*I)CHR$(48+I)
;
770 NEXT I
780 PRINT#-2
790 FORJ=1 TO 6
800 PRINT#-2,"0123456789";
810 NEXT J
820 PRINT#-2,"01234567"
830 PRINT#-2
840 PRINT"WAIT A MOMENT"

```

Set up the bytes of the file allocation table to be printed. Convert the bytes in the file allocation table to the ASC equivalent.

```

900 FOR I=1 TO 68
910 Y$=MID$(F$,I,1)
920 Y=ASC(Y$)
930 Y1$=STR$(Y)
940 ON LEN(Y1$) GOTO 950,960,990,1010
950 PRINT"SHOULD NEVER GET HERE"
:STOP
960 Y1$="0"+Y1$
970 MID$(Y1$,2,1)="0"
980 GOTO 1020
990 MID$(Y1$,1,1)="0"
1000 GOTO 1020
1010 Y1$=RIGHT$(Y1$,3)
1020 FORJ=1TO3
1030 Q$(I,J) = MID$(Y1$,J,1)
1040 NEXT J
1050 NEXT I

```

Print the file allocation table.

```

1100 FORJ=1 TO 3
1110 FORI=1 TO 68
1120 PRINT#-2,Q$(I,J);
1130 NEXT I
1140 PRINT#-2
1150 NEXT J

```

Final touches on the print-out to make it look "purty"

```

2000 PRINT#-2:PRINT#-2
2010 PRINT#-2,STRING$(80,61)
2020 PRINT#-2
2030 END

```

<b>\$ STOCK OPTION STRATEGIES \$</b>	
<p>THIS PROGRAM ALLOWS YOU TO DEVISE YOUR OWN STOCK OPTION STRATEGIES. COVERED OPTIONS, STRADDLES, CALLS AND PUTS. % GAINS AND LOSSES VS. FUTURE STOCK PRICES GRAPHED IN COLOR. EASY TO USE, NO DATA BASE REQUIRED, JUST ENTER FROM KEYBOARD. MENU DRIVEN. 16K</p>	
<p>CASSETTE \$14.95 SEND CHECK OR MONEY ORDER TO:</p>	<p>GREENTREE SOFTWARE P.O. BOX 97 GREENWOOD, IN. 46142</p>



# The Platinum Work saver<sup>®</sup>

...Programming Made Easy

## FULL SCREEN EDITING OF BASIC PROGRAMS

With the PLATINUM WORKSAVER'S editor, there's no more counting the numbers of characters to delete or change, or wondering if you deleted too many or too few. You see the whole line as it's edited. Changes, deletes and inserts are automatic and the cursor can be moved anywhere on the screen.

## FULL SCREEN EDITING OF NUMERIC AND STRING ARRAYS

But that's only the beginning! The editor (Written in machine language) also comes with a short, two line BASIC subroutine that will allow you to use the full screen editor on your numeric and string arrays. This is the springboard you need for developing your own VisiCalc™ or word processor.

## SINGLE KEY ENTRIES OF BASIC WORDS

So, the PLATINUM WORKSAVER makes it easier to write useful programs and edit them, but that's not all! Entering programs is a breeze with single entry of over 80 basic words, on a beautifully designed KEYBOARD OVERLAY, color-keyed to function. No need to memorize or consult a conversion chart to find a word.

## PROGRAM CHAINING AND DYNAMIC DEBUGGING

Now you can write, enter and change programs easily, but what about debugging? This is the frustrating, time consuming aspect of programming and frankly, the Color Computer doesn't help you much... you have to start the program over each time you make a change. But not with the PLATINUM WORKSAVER!! With it you can change, delete, add and rearrange or join lines. The special reserved key is excellent for copying or moving parts of lines to other lines... plus, you can even LOAD A WHOLE NEW PROGRAM without disturbing the data you've created.

## NUMERIC KEYPAD

We've solved another Color Computer weakness. Press a control key and letters J, K, L, U, I, O, P become number keys 1-7. Numbers 8-0 remain in their normal positions. The keypad numbers are clearly labeled on the overlay.

- Over 100 programmable keys
- 16 K min. required
- Loads to Disk
- Includes cassette merge

## A COLOR COMPUTER\* MACHINE LANGUAGE ENHANCEMENT PACKAGE THAT PROVIDES:

- Dynamic full screen editing of BASIC programs.
- Dynamic full screen editing of numeric and string arrays. The advanced user will be able to write VisiCalc™, word processor etc.!
- Single key entries for 80 commands and functions.
- Functionally laid out plastic keyboard overlay.
- Numeric Keypad conversion.
- Automatic line numbering.
- Best value per dollar than any other enhancement package available.



**With the Platinum Work saver<sup>®</sup>, programming time and hassle can be cut by 50%. You'll spend less time typing, more time being creative with your Platinum Enhanced 16K Color Computer!**

### LOOK WHAT JUST \$30 CAN DO FOR YOUR 16K COLOR COMPUTER:

Platinum Enhanced 16K Color Computer	vs.	Regular 16K Extended Color Computer
<ul style="list-style-type: none"> <li>• Relocate, join, duplicate individual and unique sets of lines at the push of a button</li> <li>• Create the following using only 31 keystrokes: CLS:AS\$-Strings\$(15"") + MID\$(CLS, 6, 2). To change the — symbol to = requires only 3 keystrokes!!!!</li> <li>• Retain the sequence of commands in temporary memory with special reserved key</li> <li>• One keypush and the right side of the keyboard converts to a numeric Keypad</li> <li>• Correct bugs while your program is running, without losing data.</li> <li>• Edit programs, data and strings using the full screen editor.</li> </ul>		<ul style="list-style-type: none"> <li>• <b>Retype</b> entirely any lines to be moved or joined</li> <li>• <b>Type</b> that line using 47 keystrokes. To change the symbol, <b>Backspace</b> and <b>retype</b> using 33 more strokes!</li> <li>• <b>Retype</b> lost lines!</li> <li>• <b>Stretch</b> those fingers!</li> <li>• Oops! <b>Lost data! Retype, Reload</b> and <b>Save</b> data while swearing a lot.</li> <li>• NO CAN DO!</li> </ul>

### THE PLATINUM WORKSAVER INCLUDES:

- Enhancement program, including a sample array Editor, on a high-quality Agfa Cassette
- Fully labeled acetate keyboard overlay, NOT a cheap stick-on
- Complete instructions
- Loads in seconds, takes less than 2K

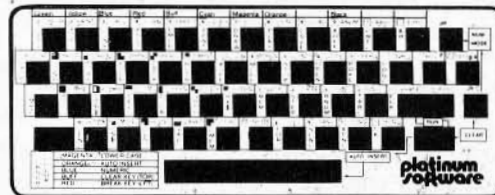

The PLATINUM WORKSAVER costs \$30.00 plus \$3.00 S&H (NY residents add tax). To order write:

**PLATINUM SOFTWARE**  
P.O. Box 833  
Plattsburgh, N.Y. 12901  
Phone orders: (518) 643-2650

VISA, MASTERCARD ACCEPTED PERSONAL CHECKS TAKE 2-3 WEEKS TO PROCESS.



**You're Serious About Your Color Computer?<sup>®</sup>**  
**SO ARE WE.**

\*Color Computer & TRS-80 are registered trademarks of Tandy Corp.

# More Organization: Create A Tape Register

By Joseph Kolar

There *is* light at the end of the tunnel! Now that you have your cassette tapes organized, there is one final household chore to get out of the way.

You are about to create a tape register. The definition and scope of the tape register will become self-evident as you proceed. On the outside cover of the notebook you were asked to purchase, stick two strips of labeling tape (neatly centered!). With a black, felt-tipped pen, neatly letter "tape index" or "tape register."

Open the notebook, and fold it so that you can rule lines on the inside cover. Draw a horizontal line about one inch below the top, across the inside cover, using a black, felt-tipped pen. A half-inch below that line, rule another line. About 1½ inches below that, rule a line. A half-inch lower, rule another line.

About one inch lower, rule a line. A half-inch lower, rule another. About an inch and a half lower, rule a third line. Count up three lines. Make a vertical line, about the width of a ruler, from the left margin and connect the three bottom lines. Make a second vertical connecting line about the width of the ruler, from the last line you drew. About 1½ inches from the right edge of the notebook, rule a third connecting line.

About an inch below the last line you ruled, rule as many lines as space will allow, about a half-inch apart, horizontally, until you reach the bottom of the page. About a ruler's width from the left margin, draw a vertical ruled line, connecting the series of lines that you ruled horizontally.

Using a red, felt-tipped pen, neatly center and print "tape index" or "tape register" between the top two lines. Between the third and fourth lines, print "format." Drop down to the next two lines, which are broken into four segments. With a regular black pen, in the left box, print "name." In the next box, print "comments." In the third, largest box, print "description" and in the right-hand box, print "evaluation."

If you have about ten boxes in the bottom portion of the inside cover, you are in business. Into the small area to the left, copy the first part of the following list, and in the large area, copy in the explanation. Of course, you can improvise your own list that best conforms with your system.

JS Joysticks required  
JS/K Joysticks or keyboard optional  
PCLEAR1 Clear memory required  
\* Graphic hi-res display  
Text Text only  
Graphic Graphics lo-res  
S Sound included  
U Utility program  
T Tutorial program  
X Experimental program  
T/G Graphic/Text combo  
ML Machine language

You will notice 12 categories listed. You may choose the ones you need or add others.

With a black, felt-tipped pen, beginning at the first page, in the lower, right-hand corner, print "A." Flip the page over and in the lower left-hand corner, print "A." Print "B" on both sides of the next sheet and continue through "Z." Letter the next nine sheets "1" through "9" on both sides in a like manner.

Return to page "A." A ruler's width from the red printed line, rule a vertical line from the top blue line to the bottom blue line. A ruler's width from the right edge, rule a second

---

***"Any program that you figure is 'lousy' shouldn't be CSAVED. There is no need to clutter up your personal library with junk."***

---

line. Do the same to all the pages that you lettered or numbered. For now, you need only to rule the right-handed pages. At your option, draw a line in black ink over the top blue printed line. It doesn't cost anything and gives it a finished appearance.

Congratulations! You have just completed your personal index.

For the sake of argument, say that on side two of your "B" labeled tape, you have a program named *Quadstar*. It is a space war type game that has hi-res graphics with sound and you may use either joysticks or arrows on the keyboard. It is an excellent game but you have to *PCLEAR* to get enough memory.

Turn to right-hand page "Q." On the top line, in the box that corresponds to the "name" box under "format" on the inside cover, print in black ink *Quadstar*. On the line underneath it, in red ink, print the address, "B2" (tape B, 2nd side). In the next column, put a "\*" because it is hi-res graphics. Next to it put "S" to designate sound. (Sometimes you forget to turn up the sound!) Underneath, in the same column, put "JS/K" to indicate that joysticks or the keyboard are optional. In the next column, write in "space war game" and some other comments of your choice that you deem necessary. At the end of the second line, print *PCLEAR*. In the last column, print your evaluation of the program. In this instance, it is "excellent." Finally, rule a black line over the blue printed line under the second row, to close out the entry.

You can use designations such as "super," "good," "very

Whether for reasons of feel, appearance, or reliability, you, like most Color Computer owners, would probably prefer a better keyboard.

Now, you can have one.

**\$89.95**



The Color Computer Professional Keyboard, with full stroke, positive action keyswitches, provides a feel normally associated with more expensive microcomputers and terminals. The finely textured keycaps, gray and black with white lettering, nicely complement the Color Computer's sleek appearance. And, the keyboard's high quality construction assures years of reliable operation. A 90-day limited warranty is provided. The four function keys, occupying the extra positions in the keyboard matrix, are an added bonus. Whether with your own software, or with that from vendors who have specially adapted theirs, (such as Frank Hogg Laboratories' FLEX), the function keys enhance the keyboard's utility. BASIC programming examples and assembly language driver listings are included. The keyboard is custom made for the Color Computer by Macrotron, an experienced manufacturer of computer components and peripherals. Consequently, installation is a simple plug-in operation, requiring no soldering or cutting whatsoever. The installation procedure is detailed in an illustrated user's manual, which is included but also available separately for \$2.00 (refundable with purchase). Two versions of the keyboard are available, one for revision E and earlier Color Computers and the other for the revision F (also known as A or ET) Color and TDP-100 computers. Please specify which version you have when ordering, if possible. Otherwise, include the complete catalog number and serial number.

### **Micronix Systems Corporation**

#7 Gibraltar Square  
St. Charles, MO 63301  
(314) 441-1694

Terms: Prepaid check or money order, Mastercard or Visa.  
Shipping Charges: U.S. \$2.00, Canada \$4.00, COD \$3.50 (No COD's to Canada).



good" to describe the rating you give to the quality of the program. Remember, this is your evaluation! Not somebody else's. Any program that you figure is "lousy" shouldn't be *CSAVED*. There is no need to clutter up your personal library with junk.

Go through all your tapes and enter them into the index. You may have to *CLOAD* and *RUN* some of the programs because you have forgotten what they were about. Once you have all of your programs listed and written up, you will have saved a lot of head-scratching.

You have finished your arts and crafts workout. It was fun to do and now your system is operational. Once again, contratulations!

Henceforth, you will be doing a lot of program transcribing. Here is a hint that will help you.

When keying in a long program, put a "scratch tape" into your cassette, (temporary storage), rewind it and set it a few counter numbers after the last program on the tape. Ideally, you should use a fresh tape, rewind it and reset the counter and run it (fast-f) to 003. You will be ready to transfer your work at a moment's notice if you are interrupted for whatever reason and must shut down.

Put a penciled tick mark next to the last line number that you listed before the interruption. Using a blank cassette index card, write in the starting counter number, a temporary program name and after you *CSAVE* what you completed, the ending counter number. Skip some counter numbers and make a second copy. You can *CLOAD* the program at a later time and continue. Do this as many times as necessary until you get a completed program and *CSAVE* it twice elsewhere in your tape library. Finally, erase both the temporary storage tape and the penciled notations on the index card, and the temporary storage tape is ready for its next mission.

## Stinger Bee-neath Reviewer's Expectations

Picture yourself as a bee catcher about to enter a hive of honeybees with your mission to catch as many honeybees as possible without being attacked by the killer bees in the hive. That's the plot in this new arcade-style game, *Stinger*, from Spectrum Projects.

As the game starts, you look down into the hive, which is a maze of concentric circles with the head of the queen bee in the center. The principal difference between this game and all those other maze games you've been playing is that the position of the openings in the circles is constantly changing, making it appear that the hive rotates along with your bee-catcher, the bees, and the killer bees.

Now to grab that joystick and start to play. Better re-read those instructions, because you start on the periphery of the hive and to move inward you must move your joystick to the left, even if the opening is to the right! Then quick, re-center that stick so that you can stay in the circle and grab some of those "X" shaped things which are the honeybees you want to catch.

What's the diamond-shaped thing about to hit me? Must have been a killer bee, because the low buzzing noises just changed as he got me. No matter, a quick check in the upper left shows I've got five catchers left—got to be more careful this time!

I'm doing great, catching bees like fury, when—annoyance! I come upon one fellow who won't let me grab him. Now I know what the directions mean when they say it may happen that I will pass over a bee and not catch him. I consider this a major flaw.

Now, what's this? Everything is speeding up like mad and I'm still on Level 1. That's right; this is one of those games where the fewer the objects on the screen, the faster everything goes. Here's where joystick control is next to impossible. More by chance than skill, I manage to get all the honeybees, and even a time bonus. No cute picture appears between screens, and the game repeats.

The very detailed instructions which come with this game say that after Level 3 the queen may have a surprise for us. Although *Stinger* was given a thorough weekend testing by my children, ages 11 and 13, and their friends, ages 9 to 13, I'm afraid none of us have yet been able to master the joystick after the game speeds up toward the end of each screen.

There was a great deal of "I wish..." going on. "I wish I could move backwards." "I wish there were cute bee pictures." "I wish there were more sound effects." "I wish I could move the joystick the direction I want to go."

All in all, although the circular maze and changing openings make this different, we gamers expect more sophisticated use of graphics, sound and the joystick controls than this game provides.

(Spectrum Projects, 93-15 86th Drive, Woodhaven, NY 11421, \$24.95 on cassette, \$29.95 on disk, \$34.95 for ROM Pack.)

—Carol Kueppers

### POWER LINE PROBLEMS?



### SPIKE-SPIKER® ...THE SOLUTION!

Protects, organizes, controls computers & sensitive, high tech electronic equipment. Helps prevent software "glitches", unexplained memory loss, and equipment damage. Absorbs damaging voltage spikes & surges, reduce costly equipment downtime. Filter models attenuate conducted RF interference. 120V, 15 Amps. Other models available. Ask for free literature for detailed specs. Call your order in today!







**DELUXE POWER CONSOLE**  
**\$79.95**

Transient absorber, dual 5-stage filter. 8 individually switched sockets, fused, main switch, and lite.

**QUAD-II \$59.95**

Transient absorber. Dual 3-stage filter. 4 sockets, lite.

**QUAD-I \$49.95**

Transient absorber, 4 sockets, lite.

**MINI-II \$44.95**

Transient absorber, 3-stage filter, 2 sockets, lite.

**MINI-I \$34.95**

Transient absorber, 2 sockets, lite.



Use your credit card or send check & we pay the shipping.

**215-837-0700**  
Out of state, order toll free

**800-523-9685 • TWX 510-651-2101**

PA Res. add 6% sales tax \* for COD add \$3.00 + shipping \* dealers invited

# WE DO BASIC BETTER!

## Experience High Resolution Graphics and Speed Unsurpassed in Color Computer Extended Basic Software

### GALLOPING GAMBLERS

Those who have tried it agree that *GALLOPING GAMBLERS* is so addictive, so exciting, that you and your whole family will sit cheering for your horse to win.

No joystick is required for this 4 player game. Place your bets on the variable odds and then wait for the sound of post time...and...they're off.

Game includes color graphics with score and birds-eye view of the race track. Can you last all twelve races?

We dare you to try.

\$18.95

### GATOR ZONE-

Is the first video computer game that takes a "byte" out of the Preppy craze! You can finally get even with those pesky Ivy League snobs by blasting away at a host of Preppy Gators on their home planet of "Prepture". You have to be quick, or the gators will gobble up your shirts! This is comic arcade fun at its best. Includes high-resolution graphics, on-screen scoring, joystick action, and three levels of play. An IMB original!

\$18.95

### STAR SIEGE PLUS-

Discussed with Space Battle games in which your space craft looks like an asterisk? *STAR SIEGE* lets you and your friend (or enemy) pilot two high resolution space ships while trading laser blasts. The first to take ten hits loses, but watch out for that pesky alien saucer! He wants to see to it that you both get vaporized.

Also includes two player *TANK TORCHER* game.

\$18.95

### METEOR STORM-

If you are bored with space obstacle games that place you as a distant observer from a point far off in space, then *METEOR STORM* is for you. Enjoy the thrill of blasting the approaching meteors from the cockpit of your own spacecraft. Watch the meteors grow in size until...!

16K Color Extended Required. Includes sound enhanced laser blasts, multi game scoring, and three levels of play.

\$12.95

### SELECT-A-GAME-

combines 3 of IMB's finest bonus games in one simple load! You can switch back and forth from "ALPINE ALIENS", "OH, GOBI!", and "ZELDA'S BAT BOTTLE". All contain stunning color graphics and high speed action. Even if you already own one or more of these games, you will want this fine package.

\$18.95

### MICRO-MATH SKILLS QUIZ-

is a fine math drill for students at or below the 3rd grade math level. includes automatic grade tally, and INKEY entry with large print, high-resolution graphics. This is a must for educators!

\$12.95

### CREATAVADER-

Now you can design your own "Invader-style" game for your Color Computer. Includes all the routines needed for customizing the creatures you hate the most. Full instructions included. Create your own targets or select from a menu of seven pre-designed four color targets.

\$18.95

### COLOR WORDCLONE-

Turn your Color Computer into a supertypewriter. Screen displays 50 characters by 23 lines in real upper and lowercase. User modifiable. Remove our character generator and use it in your own basic program. This is an easy to use word processor. The character generator alone is worth the price of the tape. Works with tape or disk.

\$18.95

### KOSMIC KAMIKAZE-

Our best selling high-resolution, deep space arcade game which the RAINBOW called "...the best spaceship graphics we have seen in a non-machine language program." Battle high speed alien saucers, decoy ships, bonus killer crafts and speeding comets.

\$18.95

ADVANCED

### STAR\*TRENCH WARFARE-

This High Resolution Color Game has the most elaborate graphics of any Color Computer Game created to date. You'll be amazed by the remarkable speed and flicker-free animation found in this graphic space challenge. Program includes a moving trench, cockpit perspective, on-screen rapid scoring, energy and ship gauges, automatic high score tally, joystick control, and a recharge and crash sequence you'll have to see to believe. Use your own 3-D glasses and add an amazing sense of depth to this classic game. Truly a must for every Color Computer.

\$18.95



### STARBASE ATTACK-

Why be a loser? Here's an arcade game you can play to win. In other space city defense games you play until you lose. *STARBASE ATTACK* is totally different. Your mission is to clear a path for the escape vehicles which will carry your people to safety. Not only that, but you must also maneuver your own escape before alien warheads or a wave of killer asteroids level your dome-covered cities. You control high energy laser blasts and expansion shields, but watch out! You might end up the one who doesn't escape.

\$12.95

SUPER DISC WITH ALL 11 PROGRAMS  
A VALUE OF \$171.50 JUST \$59.95 POST. PAID.



ILLUSTRATED MEMORY BANKS

P.O. BOX 289

WILLIAMSTOWN, MA 01267

• VISA AND MASTERCARD ACCEPTED •  
CALL (413) 663-9648 3-7 PM. EST.



MENTION THE RAINBOW AND SELECT ONE FREE PROGRAM FOR EVERY TWO \$18.95 PROGRAMS YOU ORDER.



# Can You Deactivate *The Bomb?*

By David A. Stewart

This is a game of chance. You must guess the correct code in order to deactivate the Atomic Bomb and keep everyone from being blown up. Since the computer is generating the number on a random basis, you can never memorize the winning numbers.

It's a simple game that my children love to play. I think other Color Computer users will enjoy it, too.

## Line Description:

Lines 95-135 print the instructions and set the mood for the game. I used the INKEY function throughout the printed material so that you can read it at your own speed. If you prefer to skip the instructions, just continue to press ENTER until "ENTER YOUR COMBINATION?" appears at the top of your screen.

Lines 150-175 are the GOSUB statements which send you to the random selection of numbers sub-routine. There are five of these lines, which gives you five chances to guess the combination.

Line 177 sends you to line 195. This line is only applicable if you have not guessed the combination.

Lines 180-191 are the WIN routine. It also lets you decide whether or not to play again.

Lines 195-965 are the LOSE routine.

Line 970 sends you to line 187 where you can choose whether or not to play again.

Lines 1500-1530 are the random generator of the combination.

Lines 200 and 2050 are time delays.

## User Modification

If you wish to have more chances at guessing the combination, simply add more lines between lines 150 and 177 that say "GOSUB 1500." If you want less than five chances, delete some of the lines that are already there. You should also change the last part of line 135 from 'You have five chances...' to read the actual amount you are giving them.

If you wish to make it more difficult in another manner, you can change the amount of numbers the computer can choose from. In this listing, the computer will pick a number between 1 and 10 at random. For example, if you wish to

make it pick a number between 1 and 25, you would change line 1520 to: "If X=RND(25) then 180." Then you would change line 135 to read..."it is a number between 1 and 25." If you make the number span too large, you may find it very hard to win with only five chances, so you might want to increase the number of chances at this point.

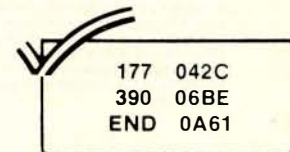

## The listing:

```

75 CLS
80 PRINT@264,"CAN YOU STOP IT?"
82 PRINT@360,"BY DAVE STEWART"
90 PRINT@480,"** AS YOU READ,PRE
SS < ENTER > TO ADVANCE THE MAT
ERIAL **"
100 Z$=INKEY$:IFZ$=""THEN100
110 CLS:PRINT"YOU ARE ON A TOUR
OF AN OLD ATOMIC BOMB CONTRO
L SIGHT. ALL BOMBS CONTAINED TH
EREIN WERE SUPPOSE TO HAVE BE
EN DEACTIVATEDYEARS BEFORE."
119 Z$=INKEY$:IFZ$=""THEN119
120 CLS:PRINT"SUDDENLY LIGHTS BE
GIN FLASHING, BUZZERS ARE GOING
OFF AND THE DOORS OF THE CONTR
OL ROOM ARE SEALED SHUT."
125 PRINT:PRINT"YOU ARE TRAPPED!
WHAT ARE YOU GOING TO DO? NO
ONE CAN EXPLAINHOW IT HAPPENED;
YOU ONLY KNOW YOU MUST STOP IT
SOMEHOW."
127 Z$=INKEY$:IFZ$=""THEN127
130 CLS:PRINT"BELOW THE FLASHING
LIGHTS IS A CONTROL PANEL. THE
SIGN ON THE PANEL READS(IN CAS
E OF EMERGENCY,ENTER SECRET CODE
    
```



```

TO DEACTIVATEBOMBS)HOWEVER,NO O
NE THERE KNOWS THE CODE."
135 PRINT"YOUR ONLY CHANCE IS TO
GUESS THE CODE.YOU HAVE ONLY ON
E CLUE--ITIS A NUMBER BETWEEN 1
AND 10.YOUHAVE FIVE CHANCES TO G
UESS IT----GOOD LUCK!!!"
140 PRINT:PRINT"PRESS <ENTER> WH
EN YOU ARE READY TO START"
145 Z$=INKEY$:IFZ$=""THEN145
150 CLS:GOSUB 1500
165 GOSUB1500
168 GOSUB1500
170 GOSUB1500
175 GOSUB1500
177 GOTO195
180 SOUND100,5:SOUND160,5:SOUND2
00,5
185 CLS:PRINT@264,"YOU WIN!!!":G
OSUB2000
186 CLS:PRINT@264,"YOU SAVED US
ALL":GOSUB2000
187 PRINT@480,"PRESS<ENTER> IF Y
OU WANT TO PLAY AGAIN"
190 Z$=INKEY$:IFZ$=""THEN190
191 CLS:GOTO110
195 PCLS
200 PMODE4,1:SCREEN1,1:PCLS
210 CIRCLE(10,20),10:SOUND10,3:P
CLS
220 CIRCLE(15,25),12:SOUND15,3
225 PCLS
230 CIRCLE(25,32),15:SOUND20,3:P
CLS
240 CIRCLE(35,40),18:SOUND25,3:P
CLS
250 CIRCLE(50,50),20:SOUND30,3:P
CLS
260 CIRCLE(68,60),25:SOUND35,3:P
CLS
270 CIRCLE(86,70),30:SOUND40,3:P
CLS
280 CIRCLE(108,80),35:SOUND45,3:
PCLS
285 CIRCLE(129,90),40:SOUND50,3:
SOUND55,3
305 PCLS(3)
310 PMODE1,1:SCREEN1,1:PCLS
320 DRAW"BM116,192;U16H8E8U4H12E
8H4E20F20G4F8G12D4F8G8D16"
325 FORS=55TO255STEP5:SOUNDS,1:N
EXTS
330 CIRCLE(100,144),20
340 CIRCLE(100,124),15
350 CIRCLE(115,115),20
360 CIRCLE(130,100),30
370 CIRCLE(145,115),20
380 CIRCLE(160,124),15
390 CIRCLE(160,144),20

```

```

400 CIRCLE(80,164),25:CIRCLE(80,
138),18
410 CIRCLE(95,125),25:CIRCLE(155
,125),25
420 CIRCLE(170,138),18:CIRCLE(17
0,164),25
430 CIRCLE(95,100),30:CIRCLE(60,
125),30
440 CIRCLE(165,100),30:CIRCLE(19
5,125),30
450 CIRCLE(30,140),30:CIRCLE(225
,140),30
460 CIRCLE(75,50),30:CIRCLE(100,
50),30
465 CIRCLE(130,50),30:CIRCLE(160
,50),30
470 CIRCLE(45,80),30:CIRCLE(20,1
10),30
475 CIRCLE(200,80),30:CIRCLE(230
,110),30
490 GOSUB2000
585 PCLS
590 PMODE4,1:SCREEN1,1:PCLS
600 DRAW"BM84,68;R85D2L85U2"
610 DRAW"BM120,68;H5E4D7"
620 DRAW"BM123,68;U16H12U2F14D15
"
630 CIRCLE(122,36),5

```

#### TRS-80 COLOR BASIC

by BOB ALBRECHT

*Beginners*

This entertaining self-instructional book is packed with games, experiments, scores of intriguing challenges, and activities related to fantasy role-playing games. The ideal introductory aid for kids, parents and teachers using the Color Computer.

John Wiley & Sons  
605 Third Ave., New York, NY 10158

\$9.95

#### TRS-80 COLOR COMPUTER GRAPHICS

by DON INMAN

*Intermediate*

Explore the creative and imaginative blending of computers and color. This exciting book will enable you to explore all the graphics capabilities of Extended Color BASIC.

Reston Publishing Company  
11480 Sunset Hills Rd., Reston, VA 22090

\$14.95

#### ASSEMBLY LANGUAGE GRAPHICS FOR THE TRS-80 COLOR COMPUTER

by DON INMAN and KURT INMAN

*Advanced*

This book is specific to the TRS-80 Color Computer with applications using sound and graphics to illustrate how an assembler can be used to perform feats that would be quite difficult, if not impossible in the BASIC language.

Reston Publishing Company

\$14.95

#### DYMAX, P.O. 310, MENLO PARK, CA 94025

Dymax orders must be prepaid via check, money order, Visa or Mastercard. Sorry, no Purchase Orders or COD orders. Please add \$2.00 shipping and handling. California residents add 6% sales tax.



# HELP WANTED

Dragon Slayers, Space Pilots, Witch Doctors, Maze Makers, Professors and other creative programmers.

## We Want You!

Your original Color Computer Software program is worth money and we want to discuss it with you...

## Earn Top Buck!



24001 ALICIA PKWY., NO. 226  
MISSION VIEJO, CA 92691  
(714) 768-1551

## COMPUTERS

Growing Company with lots of

635 CIRCLE (116, 35), 3: CIRCLE (130, 35), 3  
640 CIRCLE (117, 40), 3: CIRCLE (122, 44), 3  
650 CIRCLE (127, 40), 3: CIRCLE (118, 30), 3  
660 CIRCLE (125, 30), 3  
670 DRAW"BM126, 52; E6R3D3L1G8D12E6R2G6"  
900 DRAW"BM84, 116; U20R12F4D4G4L4F8L4H8D8L4"  
905 DRAW"BM88, 104; U4R8D4L8"  
910 DRAW"BM106, 116; U3R3D3L3"  
920 DRAW"BM120, 116; U4R4U12L4U4R12D4L4D12R4D4L12"  
930 DRAW"BM138, 116; U3R3D3L3"  
940 DRAW"BM152, 116; U20R12F4D4G4L8D8L3"  
950 DRAW"BM156, 104; U4R8D4L8"  
960 GOSUB2050  
965 PCLS:CLS  
970 GOTO187  
1000 GOTO1000  
1500 INPUT"ENTER YOUR COMBINATIO N"; X  
1520 IFX=RND(10) THEN 180  
1530 RETURN  
2000 FORT=1T0500:NEXTT:RETURN  
2050 FORT=1T01000:NEXTT:RETURN

Software Review...

## Revolution Rolls, Despite A Few 'Rough Spots'

Have you ever wondered what it would be like to drive a race car? Picture this: a car built for speed, no pollution control devices, and a total disregard for the EPA mileage ratings. I don't know about you, but I have always wanted to get behind the wheel of one of these cars and let 'er rip. Most of us will probably never get the chance to live out such a fantasy, but with a little imagination you can come close.

*Revolution* is a game in which you race against the clock in order to record the fastest lap time. It is much like qualifying for a race, because each lap around the track is timed separately. The graphics are similar to those of the arcade games that I have seen. The track moves from side to side, has straightaways and zig-zags, and you have to keep your car on track by moving your joystick left and right. If you go off the track you do not crash, but are slowed down until you get back on course. You can also vary your speed by moving the joystick forward and backward. In addition you have your choice of four cars in which to race, as well as many different tracks on which to qualify. *Revolution* also keeps track of the best times on all the tracks and records them on disk so that your best times are not lost when you end the program.

Playing *Revolution* is easy. First you select the car you wish to drive. Then you choose the track you want to qualify on as well as the number of laps you want to run. After each race, your average lap time and your best lap time is displayed. If your best lap time is a track record, you are then asked to enter your name for the records. At this point you can change cars or try another track if you like. The cars in *Revolution* are a VW (do I detect laughing out there?), a Porsche, a Ferrari and a Lotus. Each of these cars has its own speed and handling characteristics which are not only very different, but seem very realistic (not that I would really know).

When you get tired of racing on the tracks that are provided you can design your own. To do this, you first select the difficulty level of the track. The difficulty level determines how wide the track is. This can vary from very easy to almost impossible. You then map out the track by moving your joystick from left to right to form sweeping curves, straightaways, or whatever. After your track is done, you are given a chance to race on it before you have to decide whether or not to save it to disk.

*Revolution* has good graphics, but I would have liked some additional things on the screen such as road signs, scenery or the like. I also feel that the sound effects could use some improvement. These drawbacks led me to tire of the game after about one hour. The documentation supplied does a good job and, in fact, is better than that supplied with most games I have seen. Without getting into a whole discussion on the issue of software piracy, I do not feel that this review would be complete without making mention of the fact that you cannot make a backup copy of the disk that is supplied. If your disk system is like mine and occasionally wipes out your directory, it will cost you \$4 to get a replacement disk. To me this is a very serious drawback.

All things considered, *Revolution* is a good program. With a few improvements however, it could be an excellent program. If you have racing in your blood you should consider taking it for a spin.

(Inter Action, 113 Ward Street, New Haven, CT 06519,  
\$24.95 disk, \$21.95 tape)

—Gerry Schechter

# COLOR COMPUTER NEW!

## MACRO-80C

The Micro Works is pleased to announce the release of its **disk-based editor, macro assembler and monitor**, written for Color Computer by Andy Phelps. THIS IS IT — The ultimate programming tool!

The powerful 2-pass macro assembler features conditional assembly, local labels, include files and cross referenced symbol tables. MACRO-80C supports the complete Motorola 6809 instruction set in standard source format. There are no changes, constraints or shortcuts in the source language definition. Incorporating all of the features of our Rompack-based assembler (SDS80C), MACRO-80C contains many more useful instructions and pseudo-ops which aid the programmer and add power and flexibility.

The screen-oriented text editor is designed for efficient and easy editing of assembly language programs. The "Help Key" feature makes it simple and fun to learn to use the editor. As the editor requires no line numbers, you can use the arrow keys to position the cursor anywhere in the file. MACRO-80C allows global changes and moving/copying blocks of text. You can edit lines of assembly source which are longer than 32 characters.

DCBUG is a machine language monitor which allows examining and altering of memory, setting break points, etc.

The editor, assembler and monitor — as well as sample programs — come on one Radio Shack compatible disk. Extensive documentation included. **MACRO-80C Price: \$99.95**

## YOU NEED COLOR FORTH!!

Why?

- Forth is faster to program in than Basic
- Forth is easier to learn than Assembly Language
- Forth executes in less time than Basic

Forth is a highly interactive language like Basic, with structure like Pascal and execution speed close to that of Assembly Language. The Micro Works Color Forth is a Rompack containing everything you need to run Forth on your Color Computer.

Color Forth consists of the standard FORTH Interest Group (FIG) implementation of the language plus most of FORTH-79. It has a super screen editor with split screen display. Mass storage is on cassette. Color Forth also contains a decompiler and other aids for learning the inner workings of this fascinating language. It will run on 4K, 16K, and 32K computers. Color Forth contains 10K of ROM, leaving *your* RAM for *your* programs! There are simple words to effectively use the Hi-Res Color Computer graphics, joysticks, and sound. The 112-page manual includes a glossary of the system-specific words, a full standard FIG glossary and complete source listing. **COLOR FORTH ... THE BEST!** From the leader in Forth, Talbot Microsystems. **Price: \$109.95**

## SOFTWARE DEVELOPMENT SYSTEM

The Micro Works Software Development System (SDS80C) is a complete 6809 editor, assembler and monitor package contained in one Color Computer program pack! Vastly superior to RAM-based assemblers/editors, the SDS80C is non-volatile, meaning that if your application program bombs, it can't destroy your editor/assembler. Plus it leaves almost all of 16K or 32K RAM free for *your* program. Since all three programs, editor, assembler and monitor are co-resident, we eliminate tedious program loading when going back and forth from editing to assembly and debugging!

The powerful screen-oriented Editor features finds, changes, moves, copies and much more. All keys have convenient auto repeat (typamatic), and since no line numbers are required, the full width of the screen may be used to generate well commented code.

The Assembler features all of the following: complete 6809 instruction set; conditional assembly; local labels; assembly to cassette tape or to memory; listing to screen or printer; and mnemonic error codes instead of numbers.

The versatile monitor is tailored for debugging programs generated by the Assembler and Editor. It features examine/change of memory or registers, cassette load and save, breakpoints and more. **SDS80C Price: \$89.95**

## MICROTEXT: COMMUNICATIONS VIA YOUR MOEM!

Now you can use your printer with your modem! Your computer can be an intelligent printing terminal. Talk to timeshare services or to other personal computers, print simultaneously through a second printer port, and re-display text stored in memory. Dump to a cassette tape, or printer, or both. Microtext can be used with any printer or no printer at all. It features user-configurable duplex/parity for special applications, and can send any ASCII character. You'll find many uses for this general purpose module! Microtext is available in ROMPACK, ready-to-use, for **\$59.95**.

**PARALLEL PRINTER INTERFACE** — Serial to parallel converter allows use of all standard parallel printers. P180C plugs into the serial output port, leaving your Rompack slot free. You supply the printer cable. **P180C Price: \$69.95**

## GAMES

**Star Blaster** — Blast your way through an asteroid field in this action-packed Hi-Res graphics game. Available in ROMPACK; requires 16K. **Price: \$39.95**

**Pac Attack** — Try your hand at this challenging game by Computerware, with fantastic graphics, sound and action! Cassette requires 16K. **Price: \$24.95**

**Berserk** — Have fun zapping robots with this Hi-Res game by Mark Data Products. Cassette requires 16K. **Price: \$24.95**

**Adventure** — *Black Sanctum* and *Calixto Island* by Mark Data Products. Each cassette requires 16K. **Price: \$19.95 each.**

**Cave Hunter** — Experience vivid colors, bizarre sounds and eerie creatures in hot pursuit as you wind your way through a cave maze in search of gold treasures. This exciting Hi-Res game by Mark Data Products requires 16K for cassette version. **Price: \$24.95**

**Also Available:** Machine Language Monitor ★ 2-Pass Disassembler ★ Memory Upgrade Kits ★ We Stock 64K Chips  
★ Parts and Services ★ Books ★ Call or write for information

THE  
**MICRO  
WORKS**



**GOOD STUFF!**

P.O. BOX 1110, DEL MAR, CA 92014 [619] 942-2400

MasterCharge/Visa Accepted  
California residents add 6% tax.



## Corrections

Stan Peppenhorst's "Make Authoritative Decisions With This Situational Model," (Feb., 1983, page 132), had two REM statements in Lines 10 and 20, both of which landed on our "cutting room floor" by accident. REM statements don't affect the way the program runs, right?

Wrong. Many of the subsequent lines in the program have a GOTO10 at the end of the line. Hard to do with no Line 10.

The correction is simple. Just add a line 10, such as:  
10 REM VROOM

Or, you could change the several GOTO 10 statements to read GOTO30.

Ted Blatt reports the program included in his article, "Print Those Print Statements With This ML Feature," which appeared in our last issue, has an added feature you probably do not expect—or want. While it will change the PRINT statements to PRINT#-2, statements as advertised, it also puts a #-2 on LEN statements.

To rectify the problem, change Lines 140 and 150 and add Lines 142, 145, 148 and 149, as indicated below:

```
140 DATA 38, 42, 252, 62, 135, 195, 0,
1, 253, 62
142 DATA 137, 166, 159, 62, 137, 129,
35, 39, 25, 129
145 DATA 64, 39, 21, 129, 40, 38, 29, 2
52, 62, 137
148 DATA 131, 0, 2, 253, 62, 137, 166,
159, 62, 137
149 DATA 129, 255, 38, 12, 220, 31, 16
, 179, 62, 135
150 DATA 16, 39, 1, 10, 32, 185, 220, 3
1, 253, 62, 137, 252
```

With the additional DATA lines, you will need to change the number 16308 (in lines 60 and 100) to 16350. The program itself is in BASIC, but generates a machine language routine which should be saved to tape and used when the utility is implemented. Prior to CLOADMing the machine language version, you should CLEAR 350,15999.

Errors also appeared in the "Unidatfl" program in December, page 120 and 123. Here are those corrections:

Delete Line 140 and Lines 1800-2060 inclusive

Delete Line 5030

Line 5035 should read: PRINT@230, "o — open new file";

Line 5040 should read PRINT@262, "e — exit to basic";

These lines eliminate the sort function and clean up the screen display.

J.D. Ray writes that in his "Income Tax History" in our February 1983 issue, page 148, you might get an ?FC ERROR message. The problem will only occur if the range of the figures in the data statements are such that the program cannot adequately decide which graph to use. The following additions and corrections should solve any difficulties.

```
611 IF A>15 OR B>15 OR C>15 OR D
>15 OR E>15 THEN G=15 ELSE G=8
630 IF G<9 THEN GOSUB 970
```

M.P. Wilson, whose "Raindex" program was published in the January issue, reports that he has received several calls about an ?OM ERROR in Line 20. The program was written for 32K ECB, not 16K as we mistakenly noted. Even then, says Wilson, it requires a POKE25,6:NEW.

For those with 16K, he suggests the following: Before loading "Raindex," do the POKE25,6:NEW, then reduce the size of the CLEAR15000 and change the size of the array (same line) until the error goes away.

In Burton B. Witham's "Who Knows All Those Callsigns? CoCo Knows!" (Rainbow February 1983) Lines 180 through 235 and a portion of Line 240 were inadvertently left out of the accompanying listing:

```
180 PRINT@288, STRING$(32, 239)
190 K$=INKEY$: IFK$="N" THEN230
200 IFK$="Y" THENRESTORE:CLS:SOU
ND180, 1:SOUND200, 1:GOTO60
210 IFK$="" THEN190
220 GOTO170
225 '* EXIT
230 CLS:PRINT@174, "END":FORTM=1
TO999:NEXT:CLS:END
235 '* DATA LIST
240 DATA A, USA, XX, AP, PAKISTAN, 33
, A2, BOTSWANA, 110, A3, TONGA, 265, A4
, OMAN, 050, A5, BHUTAN, 20, A6, UNITED
ARAB EMIRATES, 50, A7, QATAR, 50, A9
, SAHARA, 50, B, CHINA, 344, BV, TAIWA
N, 344
```

We're sorry about these mistakes and regret any problems they may have caused.

DESERT SOFTWARE		
PRICKLY-PEAR SOFTWARE 15% OFF ALL LIST		
Viking*	19.95	16.95
Gangbuster	19.95	16.95
Football	19.95	16.95
I Ching	19.95	16.95
Numerology	19.95	16.95
Tarot	19.95	16.95
Trilogy (I Ching, Numerology, Tarot)	39.95	33.95
Phonics I	24.95	22.45
8-Bit Bartender	19.95	16.95
<b>Sugar Software</b>		
Silly Syntax	19.95	
Additional S.S. Tapes	9.95	
Fairy Tales		
Sing Along		
X-Rated		
Current Events		
Adventure		
Potpourri		
Auto Run	14.95	
TIMS (32K)	24.95	
<b>Aardvark Products</b>		
Haunted House	9.95	
Killer Bot	13.95	
Labyrinth	14.95	
Starship Herc.	14.95	
Time Trek	14.95	
Escape from Mars	14.95	
Pyramid	14.95	
Quest	14.95	
Trek Adventure	14.95	
Circle World	14.95	
Nuclear Sub	14.95	
Venture	19.95	
Tiny Compiler	24.95	
Tube Frenzy	19.95	
Derelect	14.95	
Caterpillar	19.95	
Space Battler	12.95	
Golf	9.95	
Catchem	19.95	
<b>Special Introductory Price!</b>		
<b>Dairy Educational Software (For Pre-school)</b>		
Shapes		9.95
Letters		9.95
Numbers		9.95
Big, Bigger, Biggest		9.95
All Four		@ 34.95
<b>Eigen Systems</b>		
Basic Aid (cart.)		34.95
Stripper		7.95
ocean		6.95
<b>B5 Company</b>		
Clock		24.95
Money		19.95
Math Fact		16.95
ABC's		9.95
<b>SPECIAL!!</b>		
64K RAMS Set of 8		54.95
<b>Terms:</b> Cash, money order, your personal checks welcome. No waiting to clear. Shipping - \$1.50 per order except where noted. Arizona resident add 4% sales tax. We reserve the right to change prices without notice. All programs 16K Ext. except where noted. *VIC-20 compatible. State computer when ordering.		
<b>Desert Software</b>		
P.O. Box 502, Cortaro, AZ 85230 • (602) 744-1252		



# TOM MIX SOFTWARE

• FOR THE COLOR COMPUTER & TDP 100 • 3424 College N.E., Grand Rapids, MI 49505 (616) 364-4791 •



## DONKEY KING

1982  
32K Machine Language  
**\$26.95 tape**  
**\$29.95 disk**

**ARCADE ACTION** - How high can you climb? Four full graphic screens. Exciting Sound - Realistic graphics. Never before has the color computer seen a game like this. Early reviews say: Just like the arcade - Simply outstanding!

## PROTECTORS

Exciting fast paced arcade game that looks and plays like the popular arcade game "DEFENDER",

Wave after wave of enemy fighters drop bombs on your city. Destroy them before they destroy your city. Soon the mother ships appear firing laser blasts at you. Watch for the heat seeking mines.

Your defense includes your laser cannon plus four smart bombs on each of your four ships. A new ship with each 5,000 points.

High resolution graphics with four colors make this new 32K arcade game the one for others to follow.

**\$24.95 TAPE \$27.95 DISK**



## COLOR GOLF

Now sit at your computer and play nine or eighteen holes. Outstanding graphics in the fairway or on the green. Helps your game.  
**32K EXTENDED BASIC \$17.95**

**BIRD ATTACK**-A fast paced machine language arcade game. Shoot the birdmen before they descend upon you. Watch out for their bombs! **16K Machine Language \$21.95**

**MAZE RACE**-Maze race is a one or two player game. Play either against the built in timer or against your favorite opponent. **16K Machine Code \$17.95**

**SOLO POOL**-Now play pool with your color computer. Two players. Plays like machine language. Super color. High resolution graphics. **16K Ext. Basic \$17.95**

## OTHER GREAT GAMES

ALL PROGRAMS REQUIRE 16K

**MOON LANDER**• Fantastic Graphics. Land on the Moon if you can. 2 Programs. Ext. Basic **\$17.95**

**DANCING DEVIL**• Watch him dance to music or program him yourself. Machine Language. **\$14.95**

**WAR KINGS**• Battle to save your castle and king. High resolution graphics with outstanding sound make this one a real winner. 16K Machine Language **\$17.95**

## ADVENTURES

**TREK-16**-Travel thru space with Spock and Capt. Kirk. Adventure. Tough! Ext. Basic. **\$17.95**

**SHIPWRECK**-Escape from a desert isle if you can. Great Adventure! Ext. Basic. **\$14.95**

**ESCAPE FROM SPECTRE (Graphic Adventure)**-You are a secret agent for British Intelligence sent on a mission to obtain the secret nerve gas formula being developed by S.P.E.C.T.R.E. to destroy the world. 16K Ext. Basic **\$17.95**



## SPACE SHUTTLE

1983  
32K Ext. Basic

**\$28.95 TAPE ONLY**

This program gives you the real feeling of flight. Full instrumentation complete to the max. Actual simulation of space flight. **32K Ext. Basic**



## KATERPILLAR ATTACK

Outstanding graphics and sound will end all of those trips to the arcade. So much like the arcade you have to see it to believe it. Requires Ext. Basic.

**16K MACHINE LANGUAGE \$21.95**  
**DISK \$24.95**



## SEARCH-A-WORD

This Program generates a word search puzzle to your specifications. You specify the size of the puzzle and the number of words that it is to hide within the puzzle. 16K or 32K Ext. Basic.

**TAPE \$17.95**  
**FLEX VERSION \$27.95**

## UTILITIES

**COLOR MONITOR**-Written in position independent code. (May be located in any free memory). Very compact. Only occupies 1174 bytes of memory. Full Featured. Includes Break-Pointing of machine language programs, register display and modify, memory display and modify, and block memory move commands. Displays memory in hex and ascii format on one line 8 bytes long. **MACHINE LANGUAGE \$24.95**

**ROM**-This program is a utility that will move "most" 8K Rom-Packs to disk and allow you to run them from disk. Easy to use. Requires 64K. **\$17.95**

**SCREEN PRINT ROUTINE**-Using your Epson or Microliner Printer. Print the screen contents on a full size 8 1/2 x 11 sheet. 16K Ext. Basic **\$17.95**

**TAPE DUPE**-Brand new machine language program that copies any tape effortlessly. Completely automatic. **\$16.95**

**DISK TO TAPE**-Dump the contents of any disk to tape automatically. Machine Language. **\$17.95**

**TAPE TO DISK**-Load the contents of any tape to disk automatically. Machine Language. **\$17.95**

**MAIL LIST**-Maintain a complete mailing list with phone numbers etc. Ext. Basic. **\$17.95**

**THE FIXER**-Having trouble moving those 600 Hex programs to disk? The fixer will help. Completely automatic. **\$17.95**

**TAPE CAT**-All new machine language program lists contents of tapes to printer. Make a catalog of your tapes. **\$17.95**

**PROGRAM PRINTER UTILITY**-This program will list basic programs to your printer in two column format. Saves paper and makes your listing look professional. Disk based. **\$17.95**



ADD \$1.00 POSTAGE & HANDLING  
MICHIGAN RESIDENTS ADD 4% SALES TAX

• TOP ROYALTIES PAID  
• LOOKING FOR NEW SOFTWARE



## As Arcade Battle Game, Defense Is Strikingly Good

Perhaps in keeping up with the times, Spectral Associates should have named their new program "Dense Pack" instead of *Defense*. This game is very similar to the popular arcade game in which you must defend the friendly cities from a nuclear attack.

In *Defense*, instead of defending cities, you defend outposts. The game instructions claim that you are defending them from a laser attack, but everyone knows that lasers travel at the speed of light and those are really warheads streaking across the screen trying to annihilate your ammo supply and the outposts which you are attempting to defend.

There are three outposts on each side of your main defense base where your ammo is stored. In addition, there are two extra ammo dumps which you can call upon if you run out. The play starts with the enemy "lasers" beaming slowly down onto these targets. Your defense is to fire your laser, which you direct with a joystick controlled cross hair, in front of the downwardly plummeting beam. Your laser blast causes an explosion at the location of the cross hairs which destroys the incoming beam if you are lucky enough to have engulfed it in the blast. This blast lingers on the screen long enough so that if you place it in a strategic location you can destroy several incoming beams. In the early stages of the game you have a luxurious supply of ammo but good gamesmanship dictates that you use it

conservatively because part of the scoring comes from how much ammo is left in reserve after an attack is over.

In any realistic depiction of a battle of this nature, the object is to see how many of the enemy you can take with you before you are destroyed. The attacks occur in waves. After a wave, if any of your outposts have survived you are resupplied with ammo. After every other wave, the level of intensity of the attack increases in both the number and the speed of the incoming "laser beams." At the higher levels, you are subjected to not only the beams streaking across your defense screen but to "flip charges" and "buzz bombs." These weapons are very difficult to defend against because they apparently have some type of radar built into them that senses your laser blast and attempts to outmaneuver your defenses. It requires a very accurate shot to destroy these devices.

Points are scored based on the number of beams, charges, and bombs that you stop on each wave as well as the number of outposts and amount of ammo that is left. For each 10,000 points you receive a bonus outpost.

*Defense* is a very fast machine language program that requires 16K and joysticks. With few exceptions, this game plays like the "missile" arcade game. The graphics display, in multi-color high resolution, is good. The author has built in the ability to toggle between color sets during play by pressing a key. Sound, except as noted below, is integrated very well into the play of the game. The progression of play in terms of difficulty is excellent and will not frustrate first time users. Joystick response is quick and accurate.

I believe that *Defense* is a good piece of software, and would make an excellent addition to any Color Computer game players library. The author has thought about the little things that are often overlooked but make the difference between a good and a great game. It has easy to read on-screen scoring, and the ten highest scores are recorded arcade style with the player's initials. After your impending defeat, you can see if you made the list. The only criticism I have is very minor and is related to the lack of an explosive sound when the "beam" hits an outpost or your ammo dump. It is hard to notice this slight deficiency until you run out of ammo and have to sit back and watch your outposts destroyed by the incoming beams - in silence.

Instructions for the game are complete. Spectral Associates very nicely includes a disk version of the program on the tape, and instructions on how to load it onto a disk. They also give you a number to call if you have problems with their products. And, there is more; if you should accidentally erase the tape, for only \$1.50 and the original tape, they will replace the program. Now, that is what I call "product support."

(Spectral Associates, 141 Harvard Avenue, Tacoma, WA 98466, \$21.95)

-Tom Szlucha

COLOR  
COMPUTER  
WEEKLY

NEW!

CAN YOU AFFORD \$1 A WEEK?

The CCW Newsletter will give you this if you can:

- An issue loaded with program listings of all sorts (for just a buck a week—unbelievable)!
- Latest news and information — if it happens on Monday you'll know about it by Friday (for a mere 100 cents a week)!
- Mailed out to you first class every week! (At last a reason to live from week to week)!
- Free software/hardware manufacturer's directory (This alone is worth the price of the subscription, and we even send regular updates to subscribers.)!

All it takes is ten thin dimes a week to bring meaning to your life. Cumulatively we'll take payment in the following ways:

- Charge my Visa or MasterCard at once for the full amount (\$52/year)
- Charge my Visa or MasterCard quarterly at the rate of \$13 every three months
- Here's my check for \$14 for the first quarter, bill me in three months for the next quarter (we have to charge you extra to send out those bills)
- Here's my check for \$52 for the full year hurry and send me my first issue

Name \_\_\_\_\_

Address \_\_\_\_\_

City \_\_\_\_\_ State \_\_\_\_\_ Zip \_\_\_\_\_

Visa  MC Exp. Date \_\_\_\_\_ # \_\_\_\_\_

Tiny Signature \_\_\_\_\_

Send to: CCW • P.O. Box 1355 • Boston, MA 02205

## 64K for \$99!

We will convert any Radio Shack Color Computer to a full 64K for only \$99.00 plus shipping. (Compare this with RS price of \$149 + \$30 labor for 32K upgrade.) No matter what board you have — No matter what ROM you have — Typically 24 hour turn around — Includes hardware modification to access the entire 64K, with special software and instructions on use of the upper 32K. Pack your computer well. Include cashiers check, money order, or personal check (allow 2 weeks for personal checks) for \$104.00 (\$99.00 + \$5.00 shipping) to PYRAMID. You may pay also by Mastercharge or return COD. We will treat your computer tenderly and rush it back to you.

PYRAMID — 527 Hill St. - Santa Monica, CA - 90405 - (213) 399-2222





# INTERNATIONAL SOFTWARE INC.

(604) 474 2271

771 HOCKLEY AVE, VICTORIA, B.C. V9B 2V5

TOP STIX, IS A JOYSTICK INTERFACE FOR THE COLOR COMPUTER, IT WILL ALLOW YOU TO USE THE FAMOUS ATARI JOYSTICK AND EVEN DATASOFT'S LESTICK, THE TOP STIX WORKS ON MOST PROGRAMS BUT NOT ALL. GET THE FEEL OF ARCADE FUN ORDER YOURS NOW \$29.95

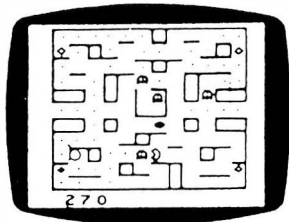

**GHOST GOBLER**  
\$27.95

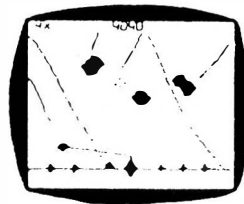

**DEFENSE**  
\$27.95

TO ORDER SEND CHEQUE OR MONEY ORDER, VISA NO#, AND EXP DATE TO ADDRESS ABOVE. PLEASE ALLOW 2 TO 3 WEEKS FOR DELIVERY.

CATALOGUE WITH EVERY ORDER

**PLANET INVASION**  
\$27.95

**CCTHELLO**  
\$22.95

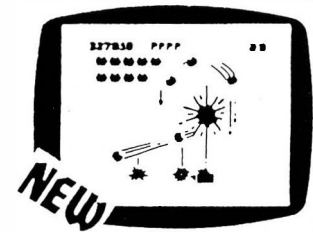

**GALAX ATTAX**  
\$27.95

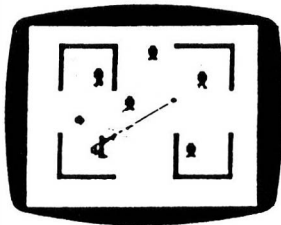

**ROBOT BATTLE**  
\$27.95

**SPACE RACE**  
\$27.95

**PIRATES AHOY**  
\$11.95

**ESCAPE FROM PRISON CITY**  
\$10.95

Please allow 2-3 weeks for delivery

NO C.O.D. ORDERS

- COUPON -

MAIL ORDER ONLY PLEASE

**20% OFF**  
**any order over \$30.00**

*Include this coupon with your order to get this special offer.*

- COUPON -



CANADIANS ORDER IN CANADA AND SAVE. MAIL ORDER OR VISIT THE DEALER NEAREST YOU, ALL PRICES IN CANADIAN FUNDS

DEALERS ON VANCOUVER ISLAND:

IN SIDNEY: SIDNEY RADIO SHACK LTD.  
IN LADYSMITH: LADYSMITH RADIO SHACK LTD.  
IN CAMPBELL RIVER: CAMPBELL RIVER RADIO SHACK LTD.

IN VICTORIA: EXCALIBUR SYSTEMS LTD.  
IN PARKSVILLE: PARKSVILLE RADIO SHACK LTD.  
IN PORT HARDY: PORT HARDY RADIO SHACK LTD.

IN SOOKE: SOOKE RADIO SHACK LTD.  
IN COURTENAY: COURTENAY RADIO SHACK.

## Rise Through the Ranks With *Sub Hunt*

By Carl Shell

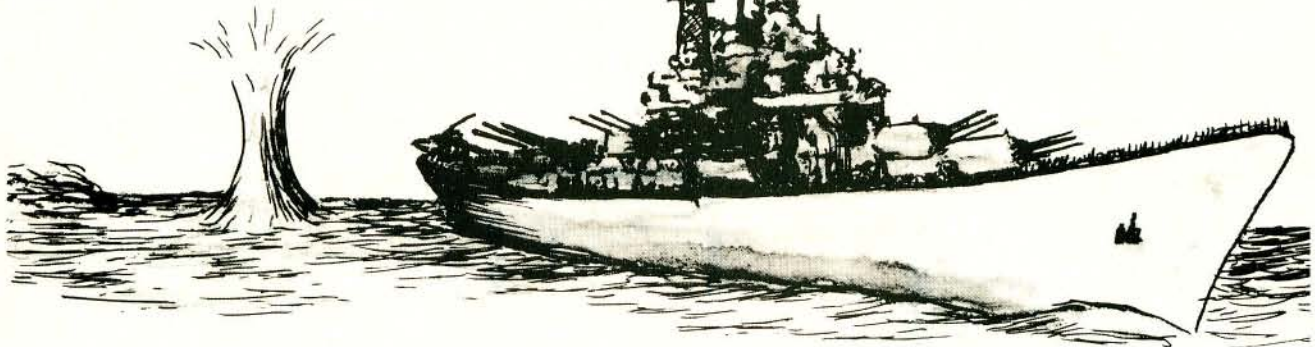

"Two points abaft the starboard beam, mates! She steams at forty fathoms! All hands on deck." Bleep...bleep...bleep...

*Sub Hunt* is a very easy game to learn, but hard enough to master so you won't get bored. I loaded it into a CoCo at a local Radio Shack store a few weeks ago, and the kids were still playing it several hours later when I returned. (Kids? The store manager was right in there with them!)

Instructions are included in the program and move you readily into action. You are the captain of a roving Destroyer, firing depth charges at the enemy submarine fleet in the murky waters beneath your hull. There are 10 subs to a fleet and each one is worth 10 points. If you wipe out an entire fleet, you receive an additional 50 points, and another fleet of 10 subs appears on the screen.

You have 500 units of time to rack up points, which you use to climb in rank to Fleet Commander, to Admiral of the Navy and all the way to Commander in Chief.

While playing *Sub Hunt*, you only have three keys to use to accomplish all the action: the "F" key fires the depth charges, the "G" key moves your Destroyer to the left, and the "H" key moves it to the right.

I hope you enjoy the sound effects and color I've put into the program; some of my friends who own other computers can't believe the CoCo can create the sounds it does in BASIC.

(Mr. Shell is one of the owners of S&S Arcade Supplies.)

2000	021A
4000	0503
11000	092F
12550	0C17
13750	0F25
END	1363

The listing:

```
400 CLS 8
500 PRINT@100,"DO YOU NEED INSTR
UCTIONS";
```

```
550 PRINT@263,"PRESS [Y] FOR YES
";
600 PRINT@327,"PRESS [N] FOR NO
";
650 II$=INKEY$
700 IF II$="" THEN GOTO 500
750 IF II$="Y" THEN GOTO 1000
800 IF II$="N" THEN GOTO 4100
1000 CLS 3
1100 PRINT STRING$(32,"X");
1200 PRINT@96,"      *****SUB-----
-HUNT*****"
1300 PRINT@192,"BY          *CARL
SHELL*"
1400 PRINT@448,"REQUIRES*****EXT
ENDED BASIC-16K"
1500 FOR YYY=1 TO 2000:NEXT YYY
1600 CLS 3:PRINT@32,STRING$(32,"
X");
1700          PRINT@96,"[***]=
YOUR DESTROYER"
1800 PRINT@192,"[G]=          MOVE
SHIP LEFT"
1900 PRINT@288,"[H]=          MOVE
SHIP RIGHT"
2000 PRINT@384,"[F]=          DEPTH
CHARGES"
2100 PRINT@448,"      TO CONTINUE P
RESS [ENTER]"
2200 IF INKEY$="" THEN 2200 ELSE
CLS 3
2300 PRINT@32,"          POINTS TO
REMEMBER"
2400 PRINT@96,"1-GAME IS 500 UNI
TS(SEC.) LONG"
2500 PRINT@160,"2-IF SUB GETS TO
```

```

TOP L. -5 PTS."
2600 PRINT@224,"3-EACH FLEET HAS
10 SUBS"
2700 PRINT@288,"4-EACH SUB WORTH
10 PTS."
2800 PRINT@352,"5-EACH FLEET WOR
TH 50 PTS.
2900 PRINT@416,"6-TIME STOPS UNT
IL CHARGES HIT"
3000 PRINT@480," TO CONTINUE P
RESS [ENTER]"
3100 IF INKEY$="" THEN 3100 ELSE
CLS 3
3200 PRINT@0," *****RATIN
G*****"
3300 PRINT@64," < = LESS TH
AN"
3400 PRINT@128," 500 = COMMAND
ER IN CHIEF"
3500 PRINT@192,"<450 = SECTRET
ARY OF NAVY"
3600 PRINT@256,"<400 = ADMIRAL
OF NAVY"
3700 PRINT@320,"<300 = FLEET C
OMMANDER"
3800 PRINT@384,"<200 = DESTROY
ER CAPTAIN"
3900 PRINT@448," PRESS ANY KEY

```

```

TO CONTINUE"
4000 IF INKEY$="" THEN 4000 ELSE
4100
4100 PMODE 0,1:PCLEAR 1:CLEAR 10
00
4200 QQ=501
4300 DIM P(9)
4400 CLS 3:PRINT STRING$(76,144)
;
4500 PRINT@44,"SUB-HUNT";
4550 FOR X=1 TO 8:NEXT X
4600 PRINT STRING$(12,144);
4700 PRINT STRING$(32,227);
4800 PRINT STRING$(96,159);
5000 PRINT@143,CHR$(158)+CHR$(15
7);
7058 PRINT@174,CHR$(156)+CHR$(14
4)+CHR$(144)+CHR$(156);
5020 FOR R=174 TO 186
5030 FOR L=143 TO 155
10000 FOR X=0 TO 9
10050 P(X)=RND(288)+221
10100 IF X=0 THEN 10200
10150 FOR Q=0 TO X-1:IF P(X)>P(
Q)+4 OR P(X)<P(Q)-4 THEN NEXT Q
ELSE 10050
10200 PRINT@ P(X),CHR$(172)+CHR$(
164);

```

# SOUTHERN SOFTWARE SYSTEMS

SERIOUS SOFTWARE FOR THE COLOR COMPUTER  
 Presenting... **THE GRAPH ZAPPER** and **THE BAR ZAPPER**  
 Line Graphs and Bar Graphs for the Color Computer

- **THE GRAPH ZAPPER** plots line graphs of data and equations - multiple lines with different symbols - mix equations and data on the same graph - plots lines or points - *"The Graph Zapper is one of the most completely documented pieces of software we have seen . . . The Graph Zapper is an outstanding utility and can be a major tool in statistical, business and other uses where graphic representation of numbers is desirable."* The Rainbow, Dec. 1982.
- **THE BAR ZAPPER** creates bar graphs with multiple bars - plenty of options - shaded or light bars - positive and negative bars - a great companion to **THE GRAPH ZAPPER** — same high quality documentation.
- Endless applications - electric consumption, stock prices, math class equations, children's height and weight, data analysis, trend indication, experimental results, statistical analysis.

### Both ZAPPERS Have All These Features:

- High resolution graphs with on screen numbers & labels, with or without grids.
- Sophisticated data editor makes changing data simple.
- Disk version has added features including storing completed graphs on disk and menu driven file loading.
- Detailed user's guides for all features.
- 14 day money back guarantee.
- Requires Ext. Color Basic and delivered on cassette.
- User friendly, easy to understand.
- Thorough error prevention.
- Save data for later graphing or editing.
- Low cost upgrade from tape to disk.
- Hard copies possible with common screen print programs - not supplied.
- Low resolution graphs can't compare.

**\$15.95**

for 16K tape versions

**\$19.95**

for 32K disk versions

add \$1.00 for shipping . . . send check or money order

\$29.95 for both tape versions + \$2.00 shipping

\$37.95 for both disk versions + \$2.00 shipping

Florida residents add 5% sales tax

## SOUTHERN SOFTWARE SYSTEMS

485 South Tropical Trail, Suite 109 • Merritt Island, Florida 32952 • (305) 452-2217





```

10250 NEXT X
10300 FOR X=0 TO 9
10350 IF P(X)=0 THEN 10600
10400 P(X)=P(X)-1
10450 IF P(X)<192 THEN PRINT@192
,CHR$(175);:GOTO 10700
10500 PRINT@ P(X)+2,CHR$(175);
10550 PRINT@ P(X),CHR$(172)+CHR$
(164);
10600 NEXT X
10650 IF A$<>"F" THEN 10750 ELSE
RETURN
10700 PRINT@ P(X)+2,CHR$(175);:X
X=XX-5:P(X)=508:GOTO 10500
10750 A$=INKEY$
10800 QQ=QQ-1:PRINT@ 0,"SCORE="
XX ;:PRINT@21,"TIME="QQ;
10850 IF QQ=0 THEN 12950
10920 IF A$="H" THEN PRINT @96, S
TRING$(96,159);:PRINT@R+2,CHR$(1
56)+CHR$(144)+CHR$(144)+CHR$(156
);:PRINT@L+2,CHR$(158)+CHR$(157)
;
10930 IF A$="H" THEN R=R+2:L=L+2
10940 IF R<162 THEN R=162
10945 IF R>186 THEN R=186
10950 IF L<131 THEN L=131
10955 IF L>155 THEN L=155
10960 IF A$="G" THEN PRINT@96,ST

```

```

RING$(96,159);:PRINT@R-2,CHR$(15
6)+CHR$(144)+CHR$(144)+CHR$(156)
;:PRINT@L-2,CHR$(158)+CHR$(157);
10970 IF A$="G" THEN R=R-2:L=L-2
11000 IF A$="F" THEN GOSUB 11300
11200 GOSUB 10300
11250 GOTO 10750
11300 II=R
11350 FOR I=0 TO 10
11400 IF I=10 THEN SOUND 1,2
11450 II=II+32
11500 IF II>511 THEN 12100
11550 GOSUB 10300
11600 PRINT@II,CHR$(173);:PLAY"T
80;05;G"
11650 FOR T=0 TO9
11700 IF P(T)=II THEN 11750 ELSE
11725
11725 IF P(T)+1=II THEN 11750 EL
SE 11950
11750 GOSUB 13800
11800 IF Z=10 THEN 12150
11825 PRINT@R,CHR$(156)+CHR$(144
)+CHR$(144)+CHR$(156);
11830 PRINT@L,CHR$(158)+CHR$(157
);
11850 P(T)=0:XX=XX+10:Z=Z+1:PRIN
T@II,CHR$(175);
11900 IF Z=10 THEN 12150 ELSE 12
100
11950 NEXT T
12000 PRINT@II,CHR$(175);
12050 NEXT I
12100 A$="":GOTO 10300
12150 Z=0
12200 CLS(0):PRINT@224,"ALL SUBS
DESTROYED!!"
12250 PRINT@32,"SCORE=" XX
"TIME=" QQ
12300 FOR TM=1 TO 15:PLAY"T45CDE
FGAB":NEXT TM
12350 FOR YYY=1 TO 800:NEXT YYY
12400 FOR AA=1 TO 7
12450 PLAY"T75C;05C;01C;05C;01C;
05C;01C;05C;01C;05C;01C;05C"
12500 CLS 3:PRINT@32," --B
ATTLE STATIONS--":PRINT@128,"
***A-L-E-R-T!***"
12550 NEXT AA
12600 CLS 3:PRINT@128," ANOTH
ER FLEET ON RADAR"
12650 PRINT@352," PREPARE DE
PTH-CHARGES!"
12700 PRINT@480," DESTROYED FLEE
T-BONUS-50 POINTS"
12750 FOR YYY=1 TO8
12800 SOUND 110,3:SOUND 10,4
12850 NEXT YYY
12900 XX=XX+50:GOTO4400
12950 FOR YYY=1 TO 8

```

SUPERIOR ORACLE SOFTWARE  
PRESENTS

# THE C C QUBE

A MAGIC CUBE SIMULATION FOR THE COLOR COMPUTER

FEATURING:

- Easy to use commands
- Fast - uses machine language routines
- Random mixes
- Undo moves or random mixes
- See all 6 faces
- Save QUBE to tape for later reload
- Only \$14.95



Send Check or M.O. to:

SUPERIOR ORACLE SOFTWARE  
P.O. Box 1505  
Greenwich, Conn. 06830

Conn. residents add 7% sales tax  
Shipping and handling included  
Personal checks require  
2 weeks to clear  
No C.O.D.s  
Requires 16K Extended Basic



```

13000 CLS 3:PRINT @64,"BATTLE IS
OVER-ENEMY RETREATED!"
13050 SOUND 1,3:SOUND 110,10
13100 FOR YYY=1 TO 600:NEXT YYY
13150 CLS 3
13200 FOR YYY=1 TO 800:NEXT YYY
13250 PRINT@192,"**A REVIEW OF Y
OUR PERFORMANCE**"
13300 FOR YYY=1 TO 800:NEXT YYY
13350 IF XX< 50 THEN PRINT"STICK
TO RAFTS":GOTO 14900
13400 IF XX<100 THEN PRINT"SAFE
IN A ROW BOAT":GOTO14900
13450 IF XX<150 THEN PRINT"DINGH
Y PILOT":GOTO 14900
13500 IF XX<200 THEN PRINT"P.T.C
REWMAN":GOTO 14900
13550 IF XX<300 THEN PRINT"DESTR
OYER CAPTAIN":GOTO 14900
13600 IF XX<400 THEN PRINT"FLEET
COMMANDER":GOTO 14900
13650 IF XX<450 THEN PRINT"ADMIR
AL OF THE NAVY":GOTO14900
13700 IF XX<500 THEN PRINT"SECRE
TARY OF THE NAVY":GOTO14900
13750 PRINT"COMMANDER-IN CHIEF":
GOTO14900
13800 CLS(0)
13850 PCLS
13900 SCREEN 1,1

```

```

13950 FOR I= 2 TO96 STEP 8
14000 CIRCLE (128,96),I:PLAY"T70
CDEFGABC"
14050 NEXT I
14100 CLS(0)
14150 PRINT@32,"      THAT WAS A
DIRECT HIT!"
14200 PRINT@160,"          GOOD S
HOT MATE"
14250 PRINT@384,"          YOU S
UNK IT!"
14300 PLAY"T99C;01C;05C;01C;05C;
01C;05C;01C;05C;01C;05C;01C;05C"
14350 FOR TM=1 TO2
14400 PLAY"T255CDEFGABCDEFGABCDE
FGABCDEFGABC"
14450 NEXT TM
14500 FOR TT=1 TO600:NEXT TT
14550 CLS 3:PRINT STRING$(76,144
);
14600 PRINT@44,"SUB-HUNT";
14650 PRINT STRING$(12,144);
14700 PRINT STRING$(32,227);
14750 PRINT STRING$(96,159);
14850 RETURN
14900 A$="T5;C;E;F;L1;G;P4;L4;C;
E;F;L1;G"
14950 B$="P4;L4;C;E;F;L2;G;E;C;E
;L1;D"
15000 C$="P8;L4;E;E;D;L2.;C;L4;C
;L2;E"
15050 D$="L4;G;G;G;L1;F;L4;E;F"
15100 E$="L2;G;E;L4;C;L8;D;D+;E;
G;L4;A;L1;03;C"
15150 X$="XA$;XB$;XC$;XD$;XE$;"
15200 PLAY X$
15250 CLS 5:PRINT@96,"**WOULD YO
U LIKE TO PLAY AGAIN**"
15300 PRINT@256,"          ENTER [
Y] FOR YES"
15350 PRINT@320,"          ENTER [
N] FOR NO"
15400 II$=INKEY$
15450 IF II$=""THEN 15300
15500 IF II$="N" THEN 15600
15550 IF II$="Y" THEN 15950
15600          CLS 0:PRI
NT@128,"          ***OK MATE***"
15650 PRINT@352,"          ***YOU ARE
DISCHARGED***"
15700 FOR YYY=1 TO 400
15750 NEXT YYY
15800 CLS 0
15850 FOR YYY=1 TO 100:NEXT YYY
15900 GOTO 15600
15950 RUN
16100 PRINT@256,"PRESS          ENT
ER"

```

## H.I.B. presents

### SOFTWARE FOR THE TRS 80 COLOR COMPUTER

#### TALK PROCESSOR ('I CAN TALK!')

Quick and easy to use. Has 26 common words. Just type in 2-letter codes and make hundreds of statements in 3 voices. Uses digitally recorded human speech. "Extremely clear", Rated "good" - *Rainbow Nov. 82* 16K Ext. Basic \$14.95

**SUB-MISSION - HI-RES COLOR ACTION GAME** for 16K Ext. Basic. **BONUS:** Order Sub-Mission and get "Missile Attack Underground" game FREE. **JOYSTICK REQUIRED** \$12.95

**"ADD-A-VOICE"** - to your own basic programs. A machine language utility (uses 4K). Generate clear human speech with just a few simple basic commands. GAME SET ('I', 'WIN', 'GOT', 'YOU', etc.) and QUIZ SET ('YES', 'NO', 'RIGHT', 'GOOD', etc.). You get both sets - over 22 words total. Specify 16K or 32K (Ext. Basic not required). Coming soon. Write H.I.B. for info. on **ADD-A-VOICE**.

For immediate shipment send certified check or money order. Personal check orders shipped in 2 weeks. Send to H.I.B. 3505 Hutch Place, Chevy Chase, MD 20815. Phone 301 656-1825 after 6 p.m. Add \$1.00 for shipping.



# NEW for the Color Computer TRS-80 'COCOCASSETTE' SUBSCRIPTION SOFTWARE

\*TRS-80 IS A TRADEMARK OF TANDY COMPANY



ENJOY A MONTHLY COLLECTION OF 8-10 PROGRAMS!  
Including games, education, home finance and more;  
on cassette for as low as **\$5.00** a month! Add some ac-  
tion and imagination to your Color Computer. . . Best of  
all, we do the work!

## LOOK AT SOME OF THE LETTERS WE RECEIVED FROM OUR SUBSCRIBERS.

"I just thought I'd let you know that your cassettes arrive in good order, load just fine, and I really enjoy your programs!"

MARION, OHIO

"I was extremely impressed by the first tape I received from you. The added extras are just super."

WILLOW GROVE, PENNSYLVANIA

"Seldom do I ever write a fan letter. Usually if something is good, nothing is ever said. I just renew the subscription or buy the product instead. T&D is an exception. I subscribe to several cassette computer magazines. Yours is certainly the most creative. The covers are original and clever. The material covered is excellent!"

PINE BLUFF, ARKANSAS

"I only entered a six-month trial but am already willing to extend my subscription!"

COOLTEWAH, TENNESSEE

## PRICES

1 YR (12 ISSUES) . .	\$55.00
6 MO (6 ISSUES) . .	\$30.00
SINGLE COPIES . . .	\$ 6.00

—MICHIGAN RESIDENTS: ADD 4% TO ORDER

—OVERSEAS: ADD \$10.00 TO SUBSCRIPTION AND \$1.00 TO SINGLE COPIES

**616 396-7577**

PROGRAMS ARE FOR  
EXTENDED BASIC  
MODEL ONLY. ISSUES  
ARE SENT FIRST CLASS.



SUBSCRIPTION SOFTWARE



IMMEDIATE SHIPMENT!  
PERSONAL CHECKS WELCOMED!  
SEND CHECK OR MONEY ORDER TO:



**T & D SOFTWARE P.O. BOX 256-C • HOLLAND, MICH 49423**

## Micro-Doc: An Aid To Organization and Access

Have you ever forgotten which of your disks or tapes held that favorite program? Did you ever forget exactly when the warranty ran out on your recently broken printer? Did you ever forget just where that little bit of crucial information is found? Well, all of the above, and then some, have happened to me. That is, until I received *Micro-Doc*.

"What is *Micro-Doc*?" you ask. *Micro-Doc* is an 8½x11, 29-page, stapled documentation manual which offers easy documentation to keep all of your information about hardware and software.

A general introduction to the use of the manual is followed by some organizational tips, and then three sections on control of your equipment, data files and programs. It also contains a summary, a glossary and a very handy master set of eight forms to aid you in the control and documentation of your efforts.

You don't have to be a technical genius to understand these simple documentation procedures. *Micro-Doc* comes with eight easy to use forms, which you can photocopy or order from *Micro-Doc*. These sheets help you organize and easily access all useful information. After a few tries I started filling out these forms without giving them much thought. They're that easy to use! Many friends found them easy to use also. And the instructions are easily followed and understood.

(*Micro-Doc*, 97 Montowese Trail, Wallingford, CT 06492. \$12.95)

—Dave Mercer

## Clock Gives Reviewer Hard Time—Vice Versa

*Clock* is a program that teaches children to read a clock and teaches the relationship between analog and digital formats. Apparently not a well thought-out educational program, *Clock* starts by asking you if you want just the analog clock or analog and digital. You are then asked how many questions you want to answer before receiving a score. Unfortunately, you are never again allowed to set these parameters, and are stuck with whatever you start with.

You are shown a clock face with a random time. This is always in multiples of five minutes. There is no provision for learning the hours alone or for learning times that aren't multiples of five like 12:33.

The best feature of this program is its ability to accept different forms of time telling. Word inputs like "After, Till, Quarter, and O'clock" can be used. You can say 110, 0110, or 10 After 1 and the program will understand them all. However, you cannot use "50 Till 2" even though it is correct. By the same token, "50 After" the hour is considered wrong even when it is correct.

A big problem is correcting mistakes when keying in an answer. There is no ability to backspace. Instead, the clear key in this 16K Extended BASIC program is used to erase the bottom of the screen where the answer is entered. This is slow and forces the child to start their answer over again completely.

A wrong answer is erased and a sound is heard. A correct answer is erased, the word "GOOD" appears for a moment and a different sound is heard. My daughter, who is learning to tell time but cannot read yet, has trouble telling if an answer is correct or not. In fact, the wrong answer sound is more interesting.

At the end of a round, a score is printed that indicates how well a child has done but not where that child is having trouble. You are then asked if you want to continue. If you say "yes" you are returned to the game you previously set-up with no possibility for changing. (switching to digital for example or changing the length of a round). If you say "no" to the question of continuing, the entire program is erased. There is no way for the program to switch from one type game to the other.

The digital game is just like the analog except that after entering the analog clock time, you must enter the time again in a digital form. This merely consists of learning to put a leading zero in front of single digit hours. For example, 1:10 becomes 01:10.

This program does not work well with children, particularly those who cannot yet read. It does not have interesting graphics, rewards, or goals. In short, there is very little to motivate or to hold the interest of a child. It is not particularly child friendly. It relies on reading ability or the close supervision of an adult. The wrong answer response is at least as much fun as the correct one if not more so, and sometimes correct answers are counted as wrong.

If you plan to teach your child to tell time yourself, and are looking for something to supplement your instruction, then this program may suit you. However, this is not a program that children will choose to play and it does not lend itself well to unsupervised play. I feel that this is not a true educational program and that it fails as a game. I cannot recommend this program.

(Tom Mix Software, 3424 College N.E., Grand Rapids, MI 49505, \$14.95)

—James Ventling

**COLORTERM I.I**

DISK COMPATIBLE VERSION AND  
NEW FEATURES INCLUDED —  
NO PRICE INCREASE

The Color Computer\* as an intelligent terminal  
with 51 or 64 columns by 21 lines  
plus true lowercase! All done in software.

Any data format — 16K or 32K — 300 or 110 Baud  
Print and save host data to cassette  
Encode data for secure storage  
User programmable keys



**Much more!**

- reverse video
- partial screen clear
- 4-way cursor control
- automatic repeat when key is held down
- enter data offline for later uploading to host
- macro buffers for often-used output
- patch the 51 or 64 column display to your own basic and assembly programs
- preserve a "window" of any size.
- new material scrolls through remainder of screen

"...Very impressed..." — The Rainbow  
"...Very pleased...high marks..." — Color Computer News  
"...Easy to use...text densities are high enough to allow doing some serious work..." — 80 Micro

Cassette and disk versions included with all orders  
add \$5.00 if you want programs on a disk

**\$34.95 (U.S.)    \$40.95 (Canadian)**  
M.O., VISA, M/C (include expiry)  
**MARTIN CONSULTING, 94 Macalester Bay**  
**Winnipeg, Man. R3T 2X5 CANADA**  
\*T.M. of Tandy Corp.

# JARB I N C SOFTWARE HARDWARE

## COMPUTER PRODUCTS

### AUX-KEY

*(Auxiliary External Key Board Unit)*

This full size, industrial grade key board unit is P.C. Board mounted for trouble free operation and years of use. Mounted in an attractive aluminum case with a 12 key numeric pad, Aux-Key comes with a long cable for remote location placement of your 80C. Requires no soldering to your computer, and only about 15 minutes for installation. Does not affect normal operation of your original key board.

Add \$4.00 Shipping ..... \$134.95

### PEN-E-ARCADE

*(Light Pen & Arcade System)*

This unique system will allow the light pen (included) to be used with supplied software for many tasks normally requiring key board input. In education, choose answers by just touching pen to correct screen location. Can be easily interfaced to your own programs. All instructions supplied. Also includes the JARB arcade target gun and target software. Shoot targets from across the room. No other unit like this is presently available from anywhere else for the 80C or TDP-100 computers.

Add \$4.00 Shipping ..... \$74.95

### COMREX CR-6500

*(13" Color Monitor)*

High resolution display monitor produces an incredibly sharp image. Includes built-in speaker with audio circuit. Compatible with virtually any microcomputer.

..... \$344.95

### COMREX CR-1

Compact desk-top daisy wheel printer, especially designed for word processing. Assures high reliability, and produces quiet, high quality printing. Complete with RS-232 interface.

..... \$810.00

**U.S FUNDS ONLY**  
**C.O.D. ORDERS ACCEPTED**  
*Sorry, no C.O.D. on printers and monitors.*

**NO CREDIT CARD ORDERS**

### \*VIDEO INTERFACE KIT

Allows the composite video signal to be interfaced directly to a B/W or color monitor. TV and monitor can be used simultaneously. Complete with comprehensive instructions and all parts, including an external sound output. NOTE: May not work with monitors requiring high input drive - call or write for recommended monitors.

..... \$19.95



### DUAL JOYSTICK UNIT (D.J.)

Single unit assembly enhances playability of multi-joystick/player games; convenient press-to-fire buttons

Add \$4.00 shipping ..... \$35.95

### EPSON PRINTERS

MX80FT/Graftrax + ..... \$524.95

MX100FT/Graftrax + ..... \$699.95

Serial Interface w/4K Buffer

Ideal for 80C use ..... \$109.95

80CTO Epson Cable ..... \$19.95

*See shipping info*

### NEW PRICES ON DATA CASSETTES

**C-05**

**C-10**

\$ .65 ..... QTY 1-10..... \$ .70

\$ .60 ..... QTY 11-20..... \$ .65

Soft Poly Cases ..... Ea. \$ .20

Hard Shelled Cases ..... Ea. \$ .22

Cassette Labels (12) ..... Sh. \$ .36

Cassette Labels Tractor (1000) .... \$30.00

*Call or write for quantity prices on all cassette products. Special lengths available, eg., C-02, etc.*

### NANOS COLOR BASIC AND EXTENDED SYSTEM REFERENCE CARD

"The New Industry Standard"  
\$4.95

*(We pay postage on this one)*

All types of Nanos cards available

### MEMORY UPGRADE KITS

#### \*4K/16K MEMORY CHIP SET

Eight 200 NS 4116 Factory Prime Chips, 16K Ram Button, and Upgrade Instructions. No Soldering.

..... \$16.95

#### \*16K/32K MEMORY UPGRADE KIT

Eight 200 NS 4116 Factory Prime Chips with Piggy Backed Sockets, Sam Socket, Bus Wire, and 32K Ram Button. Comprehensive Instructions. Recommended for "D" or earlier, but may be used on "E". Only 9 simple solder connections to kit. None to computer.

..... \$25.95

#### \*64K RAM CHIPS

Eight 200 NS Factory Prime 64K RAM Chips. Allows you to upgrade "E" board easily. No soldering needed.

..... \$69.95

*\*Installation of these items will void the Radio Shack warranty. Radio Shack is a trademark of the Tandy Corp.*

### WABASH DISKETTES

\$25.00 per box of 10

### DISK DOUBLER

\$12.95

### CoCo Chips

Sam, Pia, CPU, Ext. Basic, and 1.1 Standard Available

*We carry products  
from many manufacturers.  
If you don't see it, ask.*

# JARB I N C SOFTWARE HARDWARE

1636 D Avenue, Suite C  
National City, CA 92050  
(619) 474-6213

**SHIPPING AND HANDLING:** Printers and monitors add 3%. Unless otherwise specified, all other orders \$2.00 per order. California Residents add 6% sales tax.



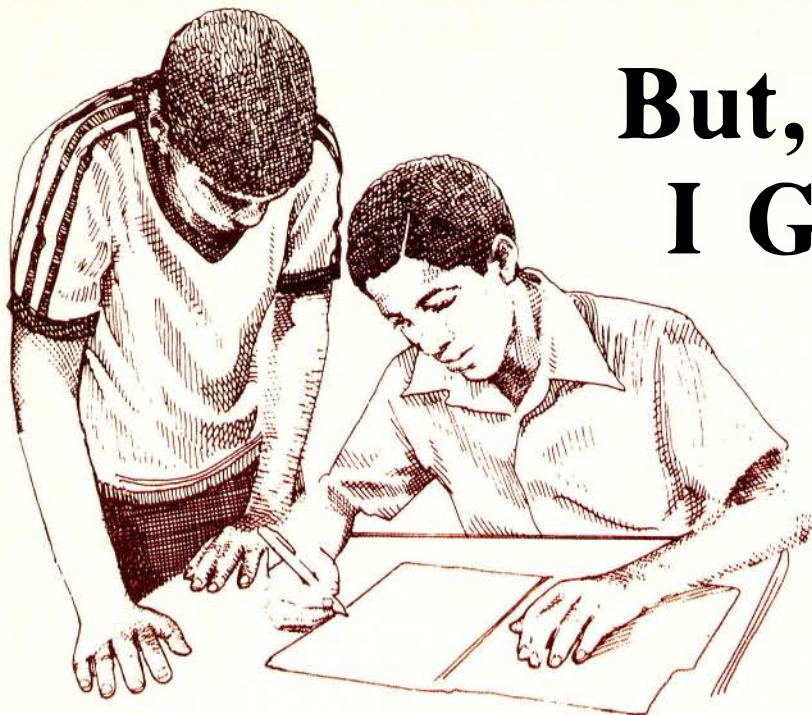

# But, What Did I Get Wrong?

By Steve Blyn

Rainbow Contributing Editor

You've got this great educational game going on your computer. It asks the child some questions in a particular category and everything appears fine. Let's check—the questions are coming up randomly. They are not repeating. You have appropriate reinforcers. Your counters and scorers are giving a correct final tally or score. What more could any kid want?

He may very well want to know which questions he got wrong. Many children cannot remember which questions they got right or wrong or maybe even which questions were asked in the first place. Sometimes children (and adults, too) get so caught up in the excitement of the program that they forget the questions and answers they have already gone through.

It's a good idea, often, to let the computer keep track of the incorrect answers and their accompanying questions. This is a good opportunity for the adult and child, or the child alone, to go over the incorrect answers and see where he went wrong. We don't want the child to merely keep playing the game until he memorizes all of the answers. We always hope for true understanding of the correct answer. A quick review of the wrong responses before proceeding to the next set of questions also acts as an extra incentive for the child to pay close attention to his answers.

Here is a short program to review the symbols for some of the most important of the chemical elements. The point of this program is that it demonstrates one easy way to use the computer to keep track of incorrect responses. If the child makes any mistakes, they are immediately saved by the program by the small array set up at lines 270-290. They are printed out at the end of each round by line 330.

This program will work on any of the CoCo models. The amount of data that you enter can be as large or as small as your needs and your computer's memory will allow. Be careful to have the "L" value on line 50 agree with the total number of your DATA pairs. Twenty-five chemical

elements were used in our program merely as an example for you to key in.

This topic may or may not be suitable for your child. Feel free to enter any data that pertains to what he is currently studying that he wishes to review. If he is having difficulty, stay with him and go over the incorrect responses as they appear on the screen. As he gains confidence, let him work on his own. When he has mastered the set of questions, enter new data in the same subject area for additional review.

*(Mr. Blyn, who teaches both exceptional and gifted children, holds two Master's degrees in the field of education and has won an award for the design of a computer program to aid handicapped children. He and his wife, Cheryl, own Computer Island.)*



100	0179
290	035C
END	05D6

The listing:

```

10 REM"ELEMENTS"
20 'STEVE BLYN -COMPUTER ISLAND,
   NEW YORK-1983
30 CT=0 '***CT IS THE COUNTER
40 W=0 '***W IS THE # OF WRONG
   EXAMPLES
50 L=25 '***L IS THE NUMBER OF D
   ATA PAIRS. IF YOU ADD MORE DATA,
   MERELY ADJUST THIS NUMBER TO MAT
   CH.
60 DIMA$(L),B$(L)
70 FOR T=1TO L:READ A$(T),B$(T):
   NEXTT
80 CLS:FORT=1024TO1119:POKET,207
    
```

```

:NEXT:PRINT@6,"elements and symb
ols";
90 CT=CT+1
100 IF CT>10 THEN 300
110 PRINT@67,"element";:PRINT@83
,"symbol";
120 R=RND(L)
130 A#=A$(R):B#=B$(R)
140 A$(R)=A$(L):B$(R)=B$(L):L=L-
1
150 PRINT@128,A$
160 PRINT@144,"";:INPUT C$
170 IF C$<>B$ THEN 210
180 IF C$=B$ THEN FORT=220T0255S
TEP5:SOUNDT,1:NEXTT
190 PRINT@320,CHR$(255);CHR$(255
);" YAY...PRESS ENTER TO GO ON";
:INPUT EN$
200 CLS:GOTO 80
210 PRINT@320,"SORRY,THE SYMBOL
IS ";B$
220 SOUND20,6:SOUND10,6
230 PRINT@386,"PRESS <ENTER> TO
GO ON";
240 W=W+1:'****# OF WRONG RESPON
ES"
250 GOSUB 270
260 INPUT ENTER$:CLS:GOTO 80
270 'REMEMBER WRONG ANSWERS HERE

```

```

280 X$(W)=A$:Y$(W)=B$
290 RETURN
300 CLS:PRINT" HERE ARE YOUR REV
IEW EXAMPLES "
310 FOR T=1 TO 32:PRINTCHR$(204)
;:SOUND230,1:NEXT
320 IF W=0 THEN FOR T=50T0250STE
P10:SOUNDT,1:NEXT:PRINT" HURRAY,
YOU MADE NO MISTAKES.":GOTO 370
330 FORT=1TOW:PRINTT;X$(T),Y$(T)
:NEXT : '****THIS IS WHERE THE WRO
NG EXAMPLES ARE PRINTED OUT.
340 DATA BROMINE,BR,CALCIUM,CA,C
ARBON,C,COPPER,CU,FLOURINE,F,GOL
D,AU,HYDROGEN,H,IODINE,I,IRON,FE
,LEAD,PB
350 DATA MAGNESIUM,MG,MANGANESE,
MN,MERCURY,HG,NICKEL,NI,NITROGEN
,N,OXYGEN,O,PHOSPHORUS,P,PLATINU
M,PT,POTASSIUM,K,SILVER,AG,SODIU
M,NA,SULPHUR,S,TIN,SN,URANIUM,U,
ZINC,ZN
360 PRINT:PRINT"YOUR SCORE WAS "
;10*(10-W);"%."
370 PRINT"WANT TO PLAY AGAIN (y/
n)";:INPUT EN$
380 IF LEFT$(EN$,1)="Y" THEN RUN
ELSE 390
390 CLS:PRINT" BYE FOR NOW":END

```

## Marymae INDUSTRIES, INC.

In Texas, Orders,  
Questions & Answers  
1-713-392-0747

22511 Katy Freeway  
Katy (Houston), Texas 77450

To Order  
1-800-231-3680  
800-231-3681

### SAVE BIG DOLLARS ON ALL TRS-80® HARDWARE & SOFTWARE

TRS-80® by Radio Shack. Brand new in cartons delivered. Save state sales tax. Texas residents, add only 5% sales tax. Open Mon. - Fri., 9 - 6, Sat., 9 - 1. We pay freight and insurance. Come by, and see us. Call us for a reference in or near your city. Ref: Farmers State Bank, Brookshire, Texas.

### WE OFFER ON REQUEST

Federal Express (overnight delivery)

Houston Intercontinental Airport  
Delivery, Same Day Service

U.P.S. BLUE—Every Day

References from people who have  
bought computers from us probably  
in your city. We have thousands  
of satisfied customers. WE WILL  
NOT BE UNDERSOLD!

ED McMANUS

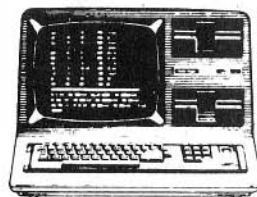

AMERICAN  
EXPRESS  
Cards  
Welcome

In stock TRS-80 Model  
II and III

No Tax on Out of Texas Shipments!

Save  
10% 15%  
OR MORE

Reserve your Model 16 Today!

TELEX: 77-4132 (FLEXS HOU)

### WE ALWAYS OFFER

- We accept MasterCard, Visa and American Express cards
- We use Direct Freight lines. No long waits
- We always pay the freight and insurance
- Toll free order number
- Our capability to go to the giant TRS-80® Computer warehouse 5 hours away, in Ft. Worth, Texas, to keep you in stock.

® TRS-80 is a Registered Trademark of Tandy Corp.

JOE McMANUS



# Homing In On A Guided Missile System

By John W. Fraysse, Jr.

## FEATURES

- \* High resolution four color graphics with random scenes
- \* Five levels of difficulty (three with maneuvering targets)
- \* Action graphics with joystick control
- \* Self explaining instructions
- \* All BASIC programming

*Cadet Trainer* is an attempt (I hope a successful one) to simulate the two phases of a command guided weapon system. That is, lock-on (or target discrimination) and terminal homing. In this game, your weapon is a "photon torpedo." Playing *Cadet Trainer* may develop one's peripheral vision and eye-hand coordination.

The graphics are programmed to simulate the apparent growth of the target as the photon torpedo closes. Note that the player is guiding the torpedo from his fighter craft. The player is *not* the torpedo but is seeing the target through the "eyes" of the torpedo itself.

## PROGRAMMING TECHNIQUES

*Cadet Trainer* is written in BASIC. The only so-called tricks are a *BREAK* key disable and the familiar speed up *POKE 65495,0* to achieve the speed I believe necessary to give good response to joystick inputs.

## PROGRAM FUNCTION

*Cadet Trainer's* initial display identifies itself and its author while playing the Air Force theme song. Optional instructions follow if needed. One must then select the difficulty level (1-5) which will be discussed later. The program will then draw the various perspectives of the target and display a flashing cross on the largest perspective pin pointing your "aim point" on the target. Press the fire button to erase the screen and draw the sector of space in which the smallest image of the target will appear at random for only an extremely short period of time.

You are now in the lock-on phase of your mission. You must position your small orange cross-hair (with the right joystick) to within eight pixels of the target's last position and press the fire button to begin the homing phase. If you achieve this, your booster motor will fire, propelling your torpedo into space where the approaching target will appear first small then progressively larger. Remember you must now position your cross-hair on the correct part of the target—your aim point. After the largest image appears, you have approximately one second before you reach the target. This time gets reduced with the higher difficulty levels. After you have reached the target your simulated warhead explodes and your miss distance for that particular mission and aim point is displayed briefly. The program then displays the aim point for the next mission. A mission consists of one lock-on phase and one homing phase. Five

missions complete one play cycle where your score is totalled. You may then replay and/or change the difficulty level or *BREAK* to exit. Your score for the entire play cycle is the sum of all your lock-on times plus your five "miss distances." Obviously, the lower the score the better. It should also be noted that the lock-on timer does not start until the first target image appears.

## DIFFICULTY LEVELS

- 1) Targets appear every time a random number between 1-20 equals 2. Targets do not maneuver and final homing time is 1.8 seconds.
- 2) Targets appear every time a random number between 1-10 equals 2. Targets do not maneuver and final homing time is 1.6 seconds.
- 3) Targets appear every time a random number between 1-7 equals 2. Targets maneuver plus/minus 50 pixels in a predictable fashion. Final homing time is 1.4 seconds.
- 4) Targets appear every time a random number between 1-5 equals 2. Targets maneuver plus/minus 100 pixels in a predictable fashion. Final homing time is 1.2 seconds.
- 5) Targets appear every time a random number between 1-4 equals 2 (FAST!). Targets maneuver as much as plus/minus 100 pixels in a random fashion. Final homing time is 1.0 seconds.

## HINTS

You may hold your button during the lock-on phase while trying to find the target. During homing the button is not used.

Try to keep the cross-hair slightly off the aim point to keep it from being lost in the target or background as your torpedo closes. Remember the target image grows. Try to anticipate your aim point's next position. Make your move to the aim point after the final (largest) image has appeared.

## SCORING

SKILL LEVEL	YOUR SCORE/DIFFICULTY LEVEL
ACE	12
FIRST CLASS	15
SECOND CLASS	20
THIRD CLASS	25
ROOKIE	30
RE-READ INSTRUCTIONS!	40

## PROGRAM LINE DESCRIPTION

10-30	Credits
40	Subroutine which draws the smallest target image



50 Subroutine which paints orange or blue in PMODE 4  
 60-80 Initial display (song, title, author, instructions?)  
 90-150 instructions  
 160-190 break key disable  
 200 dimension statements  
 210 initialize program—input difficulty level  
 220-240 random graphics background  
 250-330 target graphics  
 340 initial conditions for lock-on phase  
 350 initial conditions for homing phase  
 360-450 lock-on phase program loop  
 460-540 homing phase program loop  
 550 target "hit" display—sound—miss  
 560 increment mission counter—update running score (GOTO 250)  
 570 total score display—replay? (GOTO 210)

```

JOHN FRAYSSE
20 'BOX 822 DAHLGREN VA.22448
30 GOTO60
40 CIRCLE(B,C),2,1,1:LINE(B-6,C+1)-(B+6,C+1),PSET:PSET(B-8,C+1,1):PSET(B+8,C+1,1):PSET(B+2,C-2,1):PSET(B-2,C-2,1):RETURN
50 FOR II=0TO LN STEP2:LINE(B+II,C)-(B+II,C+HT),PSET:NEXTII:RETU
RN
60 CLS0:POKE65495,0:FORI=0TO31ST
EP2:C=RND(7)+1:FORJ=0TO63:SET(J,I,C):NEXTJ:NEXTI:POKE65494,0
70 PRINT@128," cadet tra
iner":PRINT@192," by john
fraysse":PLAY"L8;A;04;L16;C;L4;
C;03;L16;B-;L16;A;L8;G;L4;A;L4;B
-;L4;B;04;L4;C;L8;D;L16;F;L4;F;L
16;G;L16;F;L8;D;L4;C"
80 PRINT@288,"DO YOU NEED INSTRU
CTIONS(Y/N)":INPUTZ$:IFZ$="N"TH
EN160
90 CLS:PRINT"YOU ARE A SPACE CAD
ET AT THE ACADEMY. YOU ARE LE
ARNING TO USEYOUR PHOTON TORPEDO
S. YOUR GOAL IS TO LOCK YOUR TOR
PEDO ON AND GUIDE IT WITH THE R
IGHT JOYSTICKTO A SPECIFIED PART
OF THE TARGET. THE FIRST D

```

90	0306
200	0775
300	0D73
400	1218
END	1618

The listing:

**10 'CADET TRAINER FOR 16K 80C BY**



Artwork By Jack Keller

**ARK ROYAL GAMES**

P.O. Box 14806  
 Jacksonville, FL 32238

Prices on All games include shipping. Florida Resident add 5% tax.

All Programs require Color ComPuter™ (Tandy Corp) or TDP System 100 ComPuter™ (RCA)

**KAMIKAZE 32K EXT** — Fight off Takijiro Onishi's Kamikazes, find and destroy his suicide fleet before it finds you. Hi/res action graphics include: radar, search, mapscreen, fighter vs fighter, torpedo & divebomber, bomber vs ship, Kamikaze attack, and more. Hit table, repair, ready planes, target data, ship vs ship. Joystick option. 4 Levels.

**Cassette** ..... \$24.95

**KAMIKAZE 16K EXT** — Not as extensive as its big brother but with enough 'boardgame' strategy to make it more than another shoot-em-up. Using your 12 ships and 68 fighters, search & destroy Kamikazes. Joystick option, play levels.

**Cassette** ..... \$19.95

**ACROSS THE RUBICON 16K EXT or NON EXT** -- The popular WWII wargame. Break thru the Huertgen Forrest using infantry, heavy and light tanks, air & artillery strikes. Paratroops. Graphics, terrain modifiers, unit designators and 5 minute conversion instructions for 16K NON EXT. State system when ordering.

**Cassette** ..... \$19.95

From STRICTLY COLOR SOFTWARE

**MISSION EMPIRE!** A strategic wargame/strategy game. Starting with one planet, incomplete intelligence and limited resources, you must conquer the rest of your galaxy. Play takes 2-5 hours and is DIFFERENT EVERY TIME! All versions offer GAME SAVE option. Specify 32K disc or 16K-The 32K versions require Extended Basic, the 16K does not. The disc version is shipped on a cassette with instructions for transferring to disk. If you want disc, add \$3.00.

**Cassette** ..... \$19.95





# MONKEY KONG!

By Ken  
Kalish



Mario jumps into action on the Color Computer! Rolling barrels, ramps, ladders, and killer flames must be avoided in order to save the young lady from the monkey's grasp. So true to life, you'll try to insert quarters. How high can you go?



MONKEY KONG Color Computer 16K cassette.....\$24.95  
Please add \$2.00 for shipping and handling



Med Systems Software • P.O. Box 3558 • Chapel Hill, NC 27514  
TO ORDER, CALL: 1-800-334-5470



```

34,69),3,1,1:CIRCLE(164,69),3,1,
1:CIRCLE(179,86),3,1,1:LINE(116,
86)-(176,86),PSET:LINE(149,86)-(
143,80),PSET:LINE(149,86)-(154,8
0),PSET
290 LINE(137,69)-(161,69),PSET:L
INE(149,77)-(149,66),PSET:CIRCLE
(119,86),1,1,1:CIRCLE(179,86),1,
1,1:CIRCLE(134,69),2,1,1:CIRCLE(
164,69),2,1,1:PAINT(149,82),1,1,
B=143:C=86:HT=3:LN=12:GOSUB50:C
IRCLE(186,86),2,1,1:CIRCLE(194,75
),2,1,1:CIRCLE(214,75),2,1,1
300 CIRCLE(222,86),2,1,1:LINE(20
4,86)-(208,82),PSET:LINE(204,86)
-(200,82),PSET:LINE(188,86)-(220
,86),PSET:LINE(204,80)-(204,73),
PSET:LINE(196,75)-(212,75),PSET:
PAINT(204,83),1,1:B=200:C=86:HT=
2:LN=8:GOSUB50:CIRCLE(227,86),1,
1,1:CIRCLE(232,80),1,1,1
310 CIRCLE(244,80),1,1,1:CIRCLE(
249,86),1,1,1:LINE(238,86)-(236,
84),PSET:LINE(238,86)-(240,84),P
SET:LINE(227,86)-(249,86),PSET:L
INE(238,83)-(238,79),PSET:LINE(2
33,80)-(243,80),PSET:LINE(236,86
)-(240,86),PSET
320 GET(4,54)-(114,92),A,G:GET(1
16,66)-(182,92),A1,G:GET(184,72)
-(224,92),A2,G:GET(226,78)-(250,
92),A3,G
330 CIRCLE(XT(IT)+59,86-YT(IT)),
2,1,1:CIRCLE(XT(IT)+59,86-YT(IT)
),2,0,1:TI=0:IC=1:IFPEEK(65280)=
126ORPEEK(65280)=254THEN220ELSE3
30
340 R=20/L:GET(X-2,Y-2)-(X+2,Y+2
),N1,G:GOTO360
350 GOSUB40:GET(X-2,Y-2)-(X+2,Y+
2),N1,G:GOTO460
360 X1=X:Y1=Y:X=JOYSTK(0)*3.95+2
:Y=JOYSTK(1)*2.95+2:PUT(X1-2,Y1-
2)-(X1+2,Y1+2),N1,AND:GET(X-2,Y-
2)-(X+2,Y+2),N1,G:PUT(X-2,Y-2)-(
X+2,Y+2),N,OR:SOUND1,1
370 IF RND(R)=2THEN380ELSE390
380 B=RND(123)+66:C1=RND(4):C=C1
*48-10:GET(B-8,C-2)-(B+8,C+2),A4
,G:XX=B:YY=C:GOSUB40:PUT(B-8,C-2
)-(B+8,C+2),A4,AND:IF TI=0THEN T
IMER=0:TI=1
390 IFABS(X-B)<9ANDABS(Y-C)<9THE
N400ELSE360
400 P=PEEK(65280):IF P=126ORP=2
54THEN410ELSE360
410 IC=2:MM=MM+INT(TIMER/60):PUT
(X-2,Y-2)-(X+2,Y+2),N1,AND:PLAY"
V3101T100L100":FORI=0TO30:Pmode3

```

```

:SCREEN1,1:PLAY"CC+":Pmode4:SCRE
EN1,1:NEXTI:TX=B:TY=C:SX=SGN(128
-B):SY=SGN(96-C)
420 IFL<3THEN440ELSEIFL=5THEN450
ELSE430
430 FORI=1TO4:DX(I)=18*SX*L/16
:DY(I)=25*SY*L/16:NEXTI:GOTO35
0
440 FORI=1TO4:DX(I)=0:DY(I)=0:NE
XTI:GOTO350
450 DX(1)=18*SX:DX(2)=DX(1):DY(1
)=25*SY:DY(2)=DY(1):RD=SGN(RND(3
)-2):DX(3)=DX(1)*RD:DY(3)=DY(1):
DX(4)=DX(3):DY(4)=-DY(1)*RD:GOTO
350
460 FORI=66TO102-L:X1=X:Y1=Y:X=J
OYSTK(0)*3.95+2:Y=JOYSTK(1)*2.95
+2:XX=TX:YY=TY
470 PUT(X1-2,Y1-2)-(X1+2,Y1+2),N
1,AND:GET(X-2,Y-2)-(X+2,Y+2),N1,
G:PUT(X-2,Y-2)-(X+2,Y+2),N,OR:SO
UNDI,1
480 IS=INT(I/7):IFIS-I/7<>0THEN5
40
490 IS=IS-9:ON IS GOTO 500,510,5
20,530,540
500 TX=TX+DX(IS):TY=TY+DY(IS):PU
T(B-8,C-2)-(B+8,C+2),A4,AND:GET(
TX-12,TY-8)-(TX+12,TY+6),AX,G:PU
T(TX-12,TY-8)-(TX+12,TY+6),A3,OR
:GOTO540
510 TX=TX+DX(IS):TY=TY+DY(IS):PU
T(XX-12,YY-8)-(XX+12,YY+6),AX,AN
D:GET(TX-20,TY-14)-(TX+20,TY+6),
AX,G:PUT(TX-20,TY-14)-(TX+20,TY+
6),A2,OR:GOTO540
520 TX=TX+DX(IS):TY=TY+DY(IS):PU
T(XX-20,YY-14)-(XX+20,YY+6),AX,A
ND:GET(TX-33,TY-20)-(TX+33,TY+6)
,AX,G:PUT(TX-33,TY-20)-(TX+33,TY
+6),A1,OR:GOTO540
530 TX=TX+DX(IS):TY=TY+DY(IS):PU
T(XX-33,YY-20)-(XX+33,YY+6),AX,A
ND:PUT(TX-55,TY-32)-(TX+55,TY+6)
,A,OR
540 NEXT I
550 PLAY"V3101T100L100":FORI=0TO
6:Pmode3:SCREEN1,1:PLAY"CC+DD+EF
F+GG+AA+BC":Pmode4:SCREEN1,1:NEX
TI:M=INT(SQR((TX+XT(IT)-X)^2+(TY
-YT(IT)-Y)^2)):CLS0:PRINT@256,"
LEVEL=";L;"MISS=";M:FORI=
0TO2000:NEXT
560 IC=0:IT=IT+1:MM=MM+M:IFIT=5T
HEN570ELSE250
570 CLS0:PRINT@256," SCORE
=";MM;"LEVEL=";L:POKE65494,0:LIN
EINPUT" PRESS <ENTER> TO REPL
AY? ";Z$:GOTO210

```



# Telewriter-64™

## the Color Computer Word Processor

- **3 display formats: 51/64/85 columns × 24 lines**
- **True lower case characters**
- **User-friendly full-screen editor**
- **Right justification**
- **Easy hyphenation**
- **Drives any printer**
- **Embedded format and control codes**
- **Runs in 16K, 32K, or 64K**
- **Menu-driven disk and cassette I/O**
- **No hardware modifications required**

### THE ORIGINAL

Simply stated, Telewriter is the most powerful word processor you can buy for the TRS-80 Color Computer. The original Telewriter has received rave reviews in every major Color Computer and TRS-80 magazine, as well as enthusiastic praise from thousands of satisfied owners. And rightly so.

The standard Color Computer display of 32 characters by 16 lines without lower case is simply inadequate for serious word processing. The checkerboard letters and tiny lines give you no feel for how your writing looks or reads. Telewriter gives the Color Computer a 51 column by 24 line screen display with *true lower case characters*. So a Telewriter screen looks like a printed page, with a good chunk of text on screen at one time. In fact, more on screen text than you'd get with Apple II, Atari, TI, Vic or TRS-80 Model III.

On top of that, the sophisticated Telewriter full-screen editor is so simple to use, it makes writing fun. With single-letter mnemonic commands, and menu-driven I/O and formatting, Telewriter surpasses all others for user friendliness and pure power.

Telewriter's chain printing feature means that the size of your text is never limited by the amount of memory you have, and Telewriter's advanced cassette handler gives you a powerful word processor without the major additional cost of a disk.

*...one of the best programs for the Color Computer I have seen...*

— Color Computer News, Jan. 1982

### TELEWRITER-64

But now we've added more power to Telewriter. Not just bells and whistles, but major features that give you total control over your writing. We call this new supercharged version Telewriter-64. For two reasons.

### 64K COMPATIBLE

Telewriter-64 runs fully in any Color Computer — 16K, 32K, or 64K, with or without Extended Basic, with disk or cassette or both. It automatically configures itself to take optimum advantage of all available memory. That means that when you upgrade your memory, the Telewriter-64 text buffer grows accordingly. In a 64K cassette based system, for example, you get about 40K of memory to store text. So you don't need disk or FLEX to put all your 64K to work immediately.

### 64 COLUMNS (AND 85!)

Besides the original 51 column screen, Telewriter-64 now gives you 2 additional high-density displays: 64 × 24 and 85 × 24!! Both high density modes provide all the standard Telewriter editing capabilities, and you can switch instantly to any of the 3 formats with a single control key command.

The 51 × 24 display is clear and crisp on the screen. The two high density modes are more crowded and less easily readable, but they are perfect for showing you the exact layout of your printed page, *all on the screen at one time*. Compare this with cumbersome "windows" that show you only fragments at a time and don't even allow editing.

### RIGHT JUSTIFICATION & HYPHENATION

One outstanding advantage of the full-width screen display is that you can now set the screen width to match the width of your printed page, so that "what you see is what you get." This makes exact alignment of columns possible and it makes hyphenation simple.

Since short lines are the reason for the large spaces often found in standard right justified text, and since hyphenation is the most effective way to eliminate short lines, Telewriter-64 can now promise you some of the best looking right justification you can get on the Color Computer.

### FEATURES & SPECIFICATIONS:

**Printing and formatting:** Drives any printer (LPV11/VIII, DMP-100/200, Epson, Okidata, Centronics, NEC, C. Itoh, Smith-Corona, Terminet, etc).

Embedded control codes give full dynamic access to intelligent printer features like: underlining, subscript, superscript, variable font and type size, dot-graphics, etc.

Dynamic (embedded) format controls for: top, bottom, and left margins; line length, lines per page, line spacing, new page, change page numbering, conditional new page, enable/disable justification.

Menu-driven control of these parameters, as well as: pause at page bottom, page numbering, baud rate (so you can run your printer at top speed), and Epson font. "Typewriter" feature sends typed lines directly to your printer, and Direct mode sends control codes right from the keyboard. Special Epson driver simplifies use with MX-80.

Supports single and multi-line headers and automatic centering. Print or save all or any section of the text buffer. Chain print any number of files from cassette or disk.

**File and I/O Features:** ASCII format files — create and edit BASIC, Assembly, Pascal, and C programs, Smart Terminal files (for uploading or downloading), even text files from other word processors. Compatible with spelling checkers (like Spell 'n Fix).

Cassette verify command for sure saves. Cassette auto-retry means you type a load command only once no matter where you are in the tape.

Read in, save, partial save, and append files with disk and/or cassette. For disk: print directory with free space to screen or printer, kill and rename files, set default drive. Easily customized to the number of drives in the system.

**Editing features:** Fast, full-screen editor with wordwrap, block copy, block move, block delete, line delete, global search and replace (or delete), wild card search, fast auto-repeat cursor, fast scrolling, cursor up, down, right, left, begin line, end line, top of text, bottom of text; page forward, page backward, align text, tabs, choice of buff or green background, complete error protection, line counter, word counter, space left, current file name, default drive in effect, set line length on screen.

Insert or delete text anywhere on the screen without changing "modes." This fast "free-form" editor provides maximum ease of use. Everything you do appears immediately on the screen in front of you. Commands require only a single key or a single key plus CLEAR.

*...truly a state of the art word processor...  
outstanding in every respect.*

— The RAINBOW, Jan. 1982

### PROFESSIONAL WORD PROCESSING

You can no longer afford to be without the power and efficiency word processing brings to everything you write. The TRS-80 Color Computer is the lowest priced micro with the capability for serious word processing. And only Telewriter-64 fully unleashes that capability.

Telewriter-64 costs \$49.95 on cassette, \$59.95 on disk, and comes complete with over 70 pages of well-written documentation. (The step-by-step tutorial will have your writing with Telewriter-64 in a matter of minutes.)

To order, send check or money order to:

Cognitec  
704 Nob Street  
Del Mar, CA 92014

Or check your local software store. If you have questions, or would like to order by Visa or Mastercard, call us at (619) 755-1258 (weekdays, 8AM-4PM PST). Dealer inquiries invited.

(Add \$2 for shipping. Californians add 6% state tax. Allow 2 weeks for personal checks. Send self-addressed stamped envelope for Telewriter reviews from CCN, RAINBOW, 80-Micro, 80-U.S. Telewriter owners: send SASE or call for information on upgrading to Telewriter-64. Telewriter-compatible spelling checker (Spell 'n Fix) and Smart Terminal program (Colorcom/E) also available. Call or write for more information.)

Apple II is a trademark of Apple Computer, Inc.; Atari is a trademark of Atari, Inc.; TRS-80 is a trademark of Tandy Corp; MX-80 is a trademark of Epson America, Inc.



# Dumb Terminal Routine Is Pretty Smart Program

By Dan Downard

This month we will be discussing how the CoCo outputs a character on the screen. For the sake of using the existing BASIC subroutine for Machine Language programs, we will see how it operates. We will then develop our own character output routine for use with other computers. This routine is called *DMBTRM*, a shortened name for dumb terminal. What is a dumb terminal? A dumb terminal is simply a keyboard and display device that sends and receives (display) characters over a serial/RS-232 interface.

## ROM Character Output Routine

If you were to disassemble the BASIC ROM from \$A30A to \$A35D and \$A92D to \$A936, you would get a listing similar to Listing 1. Comments have been added to explain the operation. As you can see, this routine is called with the character to be output in the A register. All registers are saved. This routine is called using direct addressing at \$A30A or by indirect addressing at \$A002, assuming \$6F is set to 0. As you can see, any character less than \$20 is ignored with two exceptions, \$0D and \$08, the ASCII symbols for carriage return and backspace, respectively. Three routines contained in this listing may be of some use:

\$A30A output char. in a reg. to screen  
\$A34B scroll screen  
\$A92D

Any call to \$A34B must be preceded with a PSHS A,B,X instruction to keep the stack organized. By this time, you should have figured out that the text screen starts at \$400 and ends at \$5FF. The position of the cursor is stored at location \$88 and can be called the screen pointer of SCNPTR. This routine is fine for the majority of Machine Language programs and very convenient to use.

## DMBTRM

While trying to use my Color Computer as a dumb terminal for another computer, the need arose to have full cursor control of the screen. The particular system I was dealing with used the following ASCII codes:

\$0A (LF) line feed  
\$0D (CR) carriage return  
\$08 (BS) backspace

\$07 (BEL) bell  
\$1A (SUB) clear screen  
\$0C (FF) cursor forward  
\$0B (VT) cursor up

The program in Listing 2 is the result of this need. A similar program written for a 6801 processor in Motorola application note AN-798 was used as a guideline for this terminal. More elaborate programs are available on the marketplace that will do the same and much more but there is some satisfaction in writing and debugging your own program.

## Description Of DMBTRM

Lines 140-190 ROM locations  
Lines 190-450 Main timing loop/cursor blinking  
Lines 460-740 Serial output  
Lines 750-770 Scroll decision  
Lines 780-1130 Serial input  
Lines 1140-2140 Display char on screen

DMBTRM uses a non-destructive cursor, that is, the cursor does not erase the character as it moves. It operates at 300 baud and has proved to provide reliable operation with another 68XX computer using the Color Computer as a terminal. The listing is commented so you can pick out any of the major subroutines for use on your own customized terminal.

## How To Input Your System

I realize that many readers are not familiar with machine code programming, so a short explanation of Listing 2 is in order. This program was written using the Radio Shack *EDTASM+* ROM Pac. The listing can be explained for a typical line as follows:

```
3000 8E 0600 00190 START LDX # $600
CLEAR LINE
```

Memory address: 3000  
Machine code: 8E 0600  
Line number: 00190  
Symbol: START



Nemonic operator: LDX  
 Operand: #\\$600  
 Comments: CLEAR LINE

These different locations are called fields and fully explained in the *EDTASM+* manual. The reason I am describing the fields is to point out the different ways of inputting a Machine Language program.

**Method #1—Put Machine Code In Memory**

Using a Machine Language monitor such as *C-BUG*, *SIGMON*, *HUMBUG*, *Z-BUG*, etc., you would input this program by using the *MEMORY EXAMINE* command. Start at memory location \$3000 and input column 2 until you reach memory location \$3196.

**Method #2—Use An Assembler**

Using an Editor/Assembler such as *EDTASM+* or *SDS-80C*, input columns 3 through 6 as a file. For the *SDS-80C*, line numbers are optional so omit column 3. Column 7 is optional on all assemblers. After inputting the text file use the proper command to assemble the file and the assembler will put the program in memory for you.

**Method #3—Poke Using BASIC**

As in method #1, start at memory location \$3000 and using *POKE* or *DATA* statements transfer the machine code into memory.

After you have put the code into memory be sure to save a copy to tape before running. It's a lot easier to find a mistake than to retype the entire code or file. The entry address is \$3000 or *EXEC&H3000* and *ENTER*.

**Conclusion**

As I mentioned before, there are many commercial software programs that perform this task (and probably do a better job). Refinements consist of buffers, variable baud rates and character formats, save and load buffers from tape or disk. They are very reasonable and well worth the investment. At the same time, much can be learned by doing it yourself.

The listing:

```

00100 *DUMB TERMINAL
00110 *DAN DOWNARD
00120 *REV 0 1/83
00130 ORG $3000
00140 POLCAT EQU $A1C1 ROM CALLS
00150 CLS EQU $A928
00160 PIAO EQU $FF20
00170 PIAI EQU $FF22
00180 SOUND EQU $A948
00190 START LDX #\$600 CLEAR LINE AFTER
00200 LDA #\$60 END OF SCREEN
00210 STA CHR FOR SCROLLING
00220 FILL STA ,X+
00230 CMPX #\$620
00240 BNE FILL
00250 JSR CLS
00260 LDX #\$400
00270 WRCUR LDA #\$AF PUT CURSOR
00280 STA 0,X ON SCREEN
00290 BSR TIMER
  
```

```

00300 ERCUR LDA CHR PUT CHAR
00310 STA 0,X ON SCREEN
00320 BSR TIMER
00330 BRA WRCUR
00340 TIMER PSHS X CONTROL LOOP
00350 LDX #\$FF
00360 MORE BRA CHKC KEYBOARD
00370 CONT STX TEMPX
00380 PULS X
00390 BSR SERTST SERIAL IN
00400 PSHS X
00410 LDX TEMPX
00420 LEAX -1,X
00430 BNE MORE
00440 PULS X
00450 RTS
00460 CHKC JSR POLCAT KEY PRESSED?
00470 BNE OUT
00480 BRA CONT
00490 OUT PULS X SEND IT
00500 PSHS A,B,X,CC
00510 DRCC #\$50
00520 BSR OUT2
00530 CLR B
00540 BSR OUT3
00550 LDB #\$08
00560 OUT1 PSHS B
00570 CLR B
00580 LSR A
00590 ROL B
00600 ASL B
00610 BSR OUT3
00620 PULS B
  
```

IT'S HERE!!

**DYNABYTE SOFTWARE™**  
 TSASA, INC. PRESENTS  
**COLOR COMPUTER**  
 BUSINESS & HOME SOFTWARE  
 That'll KNOCK Your Mainframe  
OUT!  
**50 CASSETTES \$8.95-\$29.95**

INCLUDING...

The Accountant	\$29.95	Checkbook Booky	\$12.95
Business Inventory	\$18.95	At Home Inventory	\$12.95
The Billing Solver	\$19.95	Dear Diary	\$12.95
The Client Tickler	\$19.95	The Tape Geni	\$9.95
Cash Flow Model	\$13.95	The Phone Directory	\$9.95
The Bidder	\$14.95	The Mailman	\$13.95
Linear Regress	\$16.95	Home Budget	\$12.95

AND MANY, MANY MORE!  
 (16K Rec.)

**FREE CATALOG**

DYNABYTE 2 Chiple Run, West Berlin, N.J. 08091  
 TELEPHONE 609-346-3063

Add \$1.50 Postage and Handling and \$1.50 C.O.D.

NAME \_\_\_\_\_

ADDRESS \_\_\_\_\_

```

00630      DECB
00640      BNE      OUT1
00650      BSR      OUT2
00660      PULS    A,B,X,CC
00670      BRA      TIMER
00680 OUT2  LDB      #02
00690 OUT3  STB      PIA0
00700      BSR      OUT4
00710 OUT4  LDX      #BE
00720 OUT5  LEAX    -1,X
00730      BNE      OUT5
00740      RTS
00750 ENDSCN CMPX    #600  SCROLL?
00760      LBGE    SCROL
00770      RTS
00780 SERTST LDB      PIA1  SERIAL INPUT?
00790      ASRB
00800      BCC      INCH
00810      RTS
00820 INCH  PSHS    X,B,CC  INPUT CHAR
00830      DRCC    #50
00840 INCH1 LDA      PIA1
00850      ASRA
00860      BCS      INCH1
00870      BSR      WAITH
00880      LDA      PIA1
00890      ASRA
00900      BCS      INCH1
00910      CLRA
00920      PSHS    A
00930      LDB      #7
00940 INCH2 BSR      WAIT1

```

```

00950      LDA      PIA1
00960      NOP
00970      ASRA
00980      ROR      0,S
00990      DECB
01000      BNE      INCH2
01010      BSR      WAIT2
01020      PULS    A
01030      LSRA
01040      PULS    B,X,CC
01050      BSR      SER
01060      BSR      ENDSCN
01070      RTS
01080 WAIT2 BSR      WAIT1
01090 WAIT1 BSR      WAITH
01100 WAITH LDX      #B6
01110 WAIT  LEAX    -1,X
01120      BNE      WAIT
01130      RTS
01140 SER   ANDA    #7F  DISPLAY CHAR
01150      PSHS    A
01160      ANDA    #60  CNTL CHAR?
01170      BEQ    CNTRL
01180      PULS    A
01190      CMPA    #40
01200      BGE    SER1
01210      ORA     #40
01220 SER1 STA     0,X  STORE CHAR
01230      LEAX    1,X  ON SCREEN
01240      BRA     SAND
01250 CNTRL PULS    A
01260      CMPA    #0A  LINE FEED?
01270      BEQ    LINEF
01280      CMPA    #0D  CARRIAGE RETURN?
01290      BEQ    CARRET
01300      CMPA    #08  BACKSPACE?
01310      BEQ    BACKSP
01320      CMPA    #07  BELL?
01330      BNE    CLRSCR
01340      JMP    SOUND
01350 CLRSCR CMPA    #1A  CLR SCREEN?
01360      BNE    MORECH
01370      LDB     #60
01380      STB     CHR
01390      JSR     CLS
01400      LDX     #400
01410      RTS
01420 MORECH CMPA    #0C  FWD CURSOR?
01430      BEQ    FWDC
01440      CMPA    #0B  UP CURSOR?
01450      BEQ    UPCUR
01460      RTS
01470 LINEF LDB     CHR  LINE FEED
01480      STB     0,X
01490      LEAX    32,X
01500      STX     TEMPX
01510      CMPX    #600
01520      BNE    SAND
01530      BSR    SCROL
01540      LDD     TEMPX

```

## Y-PAK Dual Slot Expander for Radio Shack's Color Computer

Have your Disk and Cartridge too!  
Select between 2 Cartridge slots with one  
switch and control the Auto Start with  
the other switch.

**\$70.00** Complete

## USER-PAK for Color Computer

Your own RAM/EPROM Cartridge

Cartridge holds two 2732s, or any combination  
of four 2716s/6116s.

**\$30.00** less RAM/EPROM  
**\$90.00** with 8K RAM

EPROMs burned from your CC cassette.  
Write for details.

**B. Erickson**

P.O. Box 11099 Dept. RB  
Chicago, IL 60611

# INTERNATIONAL COLOR COMPUTER CLUB

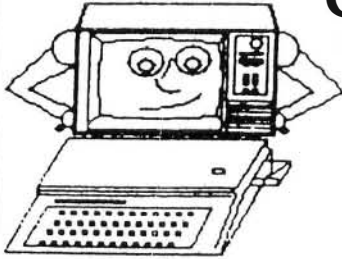

Main Office  
2101 E. Main St., Henderson, Texas 75652  
Canadian Branch  
96 Carleton Dr. Saskatoon, Saskatchewan S7H-3N6

**WORLD'S LARGEST COLOR COMPUTER CLUB**

## HERE ARE SOME GOOD REASONS FOR JOINING

- 1). **FREE PROGRAMS.** Good programs written by our members are contained in the library, in the newsletter, and on the new member tape.
- 2). **NEWSLETTER.** A "magazine" sized newsletter (last issue 80 pages), with programs, tips data, reviews, articles and much more.
- 3). **NEWSLETTER Tape** A tape of all the programs appearing in the newsletter is available from the library for \$2.00 (to members)
- 4). **CLUB LIBRARY.** The club maintains a library of programs, books and Radio Shack ROM-packs. The programs are member written and are yours to keep, there is a small fee to cover postage and tape (\$2.). The books and ROMpacks may be checked out for 3 weeks at a time. (extensions possible)
- 5). **DISCOUNTS.** get large discounts on many software and hardware items for CoCo from some of the MAJOR companies. Also discounts on subscriptions to the RAINBOW, CCN and Chromasette magazines.
- 6). **ADVERTISE FREE** Members may place ads of up to ¼ page per issue in the newsletter FREE. (The ad must be computer related)
- 7). **BORROW PARTS.** Don't wait weeks for the parts to come in from Radio Shack! Just check them out of the Clubs Parts library and return when yours arrive.
- 8). **SURPRISE.** You receive a "New member" package containing many useful items.
- 9). **GET HELP.** This is the worlds largest Color Computer Club. With members in almost every field of expertise. So if you have a problem with the Color Computer, we can almost always get you the answer. Put your problem on the Clubs Bulletin Board, write, or call.
- 10). **FIND FRIENDS** As a new member, you will receive a list of the members in your area whom you may contact for CoCo talk.

## HOW TO BECOME A MEMBER:

Write to the club for an application, there are no conditions for membership other than agreeing to obey the rules, being interested and paying the dues. The membership dues are \$30.00 per year and we believe you get more than your moneys worth. You can save more than the \$30.00 in discounts the club offers you. Example: Subscription to the RAINBOW, 25% off of regular subscription rates. Some members have told me that the new member tape alone is worth the \$ 30. it contains 10, very good programs. Some of the programs contained in the library are, Accounts Receivable, General ledger, Inventory, Sales file and ticket program with automatic Inventory update (for 32 K with 2 disc.)





```

01550   ANDB   #$1F
01560   ABX
01570   RTS
01580 CARRET LDB   CHR   CARRIAGE
01590   STB   0,X   RETURN
01600 MAS5   CMPX   #$400
01610   BNE   MAS3
01620 SAND   LDB   0,X
01630   STB   CHR
01640   RTS
01650 MAS3   PSHS   X
01660   STX   TEMPX
01670   LDD   TEMPX
01680   ANDB   #$1F
01690   BNE   MAS4
01700   PULS  X
01710   BRA   SAND
01720 MAS4   PULS  X
01730   LEAX  -1,X
01740   BRA   MAS5
01750 SCROL  LDB   #$60
01760   STB   CHR
01770   JSR   SCROLL
01780   RTS
01790 BACKSP CMPX   #$400 BACKSPACE
01800   BNE   MAS2
01810   RTS
01820 MAS2   LDB   CHR
01830   STB   0,X
01840   LEAX  -1,X
01850   BRA   SAND
01860 FWDC   LDB   CHR   FORWARD
01870   STB   0,X   CURSOR
01880   CMPX   #$5FF
01890   BNE   MAS6
01900   JSR   SCROLL
01910   LEAX  -1,X
01920 MAS6   LEAX  1,X
01930   BRA   SAND
01940 UPCUR  LDB   CHR   UP CURSOR
01950   STB   0,X
01960   LEAX  -32,X
01970   CMPX   #$400
01980   BLT   LIMIT
01990   BRA   SAND
02000 LIMIT  LEAX  32,X
02010   BRA   SAND
02020 SCROLL STX   TEMPX SCROLL
02030   LDX   #$400
02040 NOTYET LDA   32,X
02050   STA   ,X+
02060   CMPX   #$600
02070   BNE   NOTYET
02080   LDX   TEMPX
02090   LEAX  -32,X
02100   RTS
02110 CHR   RMB   1   CHARACTER
02120 TEMPX RMB   2   X-REGISTER
02130   END   START

```

---

## GRAPHICS

---

### Son Of Graphic Traffic

One of our favorite program quickies is the five-liner sent in to us by John Dana of Hamden, Connecticut. It appeared in our December 1982, issue under the title of *Graphic Traffic*. Now John has created *Graphic Traffic II: Color Crazyiness*. It's a great simulation of a CoCo that's blown its cool.

John added color by adding just two lines to his December version—lines 8 and 15—and by changing line 5 from *CLEAR 100* to *CLEAR 600*. If you missed the earlier version, just key in the lines below and *RUN* it, then hit *ENTER* twice and then a few keys, for instance, your name, for the old version. Hit the space bar several times and watch what happens.

For the color madness, *RUN* the program again, but this time enter a number (96 or above for full color—color only), and then hit *ENTER*. Now, each key on the keyboard, including the shift/zero mode, becomes a color key.

What happens is that the value you input is added to the ASCII value of the key you hit, and the character on the screen has the new ASCII number (the sum of the two values).

Careful: if the sum is greater than 255, you'll get an error code.

The effects are seemingly endless and, when you find a combination you like, you can preserve it in string or data statements—if you can remember what you did. At *Rainbow*, we find it's fun just in itself, but you could add it as a subroutine in a game program you're working on, too.

If things get a bit dizzying, particularly in the December version, add in a line somewhere, say line 35, that reads: *35 FOR X=1 TO 8: NEXT X* (a *FOR-NEXT* loop for time delay). Increase "8" to a larger number for a longer pause.

Here's the listing:

```

1 ' COLOR CRAZINESS
5 CLEAR 600
8 INPUT N
10 A$=INKEY$
15 IF A$<>" " THEN A$=CHR$(ASC(A$)+N)
20 B$=B$+A$
30 PRINT B$;
40 GOTO 10

```

---

## LISTEN UP

---

So, you've got an IO error on the first save of your favorite program, and you can't remember how far in the second save is. What to do? Just keep typing *CLOAD* until the second save finally comes up? Steve Lipps of Circle City Software has a better idea. If you put a little space between your saves, as many of us do, then you can listen for the second save. Says Steve, "Just use *AUDIO ON* and *MOTOR ON* and listen for the silent space. Then you can use *MOTOR OFF*. Even faster than *MOTOR OFF* is to hit any key and then *ENTER*, creating a syntax error which will stop the recorder." Then *CLOAD* the second save.



# From Way Up And Way Over Here's J/K Draw

Program by Aaron Fransen

As you might expect, when we get mail from Cleveland, we don't rush to the road atlas to see if it's the largest city in Ohio. On the other hand, when we get a cute little program sent to us from Revelstoke, British Columbia, it's reach for the World Book time.

Aaron Fransen lives in this westernmost province of Canada and we like to think he uses his CoCo in the seclusion of a small cabin in the Monashee Mountains near Glacier National Park. There's probably a deer grazing in the meadow just outside his window, and maybe he uses his CoCo to plot the migratory patterns of wild geese. He's probably snowed in for the winter and will have his next issue of *the Rainbow* delivered by dogsled.

Yeah, that's what we like to think. Aaron, if you're the manager of the local McDonald's and drive a Dodge, just don't tell us, okay?

More than anything else, what does set Aaron apart from most of our contributors is that he's developed a program in non-Extended BASIC. We agree with him that more programs are needed that do not require ECB.

*J/K Draw* uses both the right joystick and the arrow keys to draw block graphics pictures on the low resolution screen. Once you've completed a masterpiece, you can save it to tape, too.

Writes Aaron, "I have found that young children enjoy this program a lot when they get the hang of it." Some of us who aren't children, but who treasure and cling to those childlike qualities we still manage to possess, like *J/K Draw*, too. The colors are brilliant and clean. Doodling with *J/K Draw* is sort of like playing around with Magic Markers, those felt pens with the wide tips. We tried our hand at drawing a little cabin in the woods.

Now a LOGO for the  
COLOR COMPUTER

\*\*\*TINY TURTLE\*\*\*

TINY TURTLE is an affordable, fully compatible LOGO language with high resolution turtle graphics, music, fast processor operation, and storing and retrieval of user procedures. TINY TURTLE comes complete with soft-copy reference user manual.

32K/EXTD BASIC/CASSETTE \$39.95  
HARD-COPY MANUAL \$4.95  
SDS COMPUTERS BOGOTA, N.J.  
POB 450 07603  
N.J. ADD 5% TAX

```

300 0260
500 03EF
750 070D
END 0A7A
    
```

The listing:

```

10 CLS:PRINT" JOYSTICK/KEYBOA
RD DRAW":PRINT:INPUT" DO YOU NE
ED INSTRUCTIONS";DY$
20 IF DY$="Y"THEN560
30 X=31:Y=15:C=6
40 POKE 65495,0
50 J=1
60 CLS0
70 IFPEEK(341)=247THENY=Y-1
80 IFPEEK(342)=247THENY=Y+1
90 IFPEEK(343)=247THENX=X-1
100 IFPEEK(344)=247THENX=X+1
110 IFINKEY$="S"THEN 470
120 IFX<0THENX=0
130 IFX>63THENX=63
140 IFY<2THENY=2
150 IFY>31THENY=31
160 IFPEEK(339)=239THENC=1
170 IFPEEK(340)=239THENC=2
180 IFPEEK(341)=239THENC=3
190 IFPEEK(342)=239THENC=4
200 IFPEEK(343)=239THENC=5
210 IFPEEK(344)=239THENC=6
220 IFPEEK(345)=239THENC=7
230 IFPEEK(338)=223THENC=8
240 IFPEEK(338)=239THENC=0
250 IFPEEK(340)=253THENJK=1
260 IFINKEY$="L"THEN520
270 IFPEEK(339)=191ORPEEK(341)=2
54THENCLS0
280 IFC=0THENRESET(A1,S1)
290 SET(X,Y,C)
300 A1=X:S1=Y
310 PRINT0,"HORIZONTAL:";X," VE
RTICAL :";Y
320 IFPEEK(340)=251THEN420
330 IFJK=1THEN350
340 GOTO70
350 H=JOYSTK(0):V=JOYSTK(1)
360 IFH<20THENX=X-1
370 IFH>40THENX=X+1
380 IFV<20THENY=Y-1
390 IFV>40THENY=Y+1
400 IFPEEK(341)=253THEN JK=9
410 GOTO110
420 PRINT0,"
";
430 PRINT0,"RELOCATION OF DOT";
440 RESET(X,Y)
450 INPUT X,Y
460 GOTO70
    
```



# YORK 10

# BASF-DPS

WORLD STANDARD TAPE

**MONEY BACK  
GUARANTEE**

## COMPUTER GRADE BLANK CASSETTES

PREMIUM 5-SCREW SHELL WITH LEADER FITS ALL STANDARD RECORDERS  
PREFERRED BY SOFTWARE PRODUCERS, SCHOOLS AND BUSINESSES NATIONWIDE



DATA TRAC / C-05, C-10, C-20

### CASSETTE STORAGE CADDY

**NEW!**

ORGANIZE  
YOUR TAPES!  
**\$2<sup>95</sup> EACH**



STACKABLE

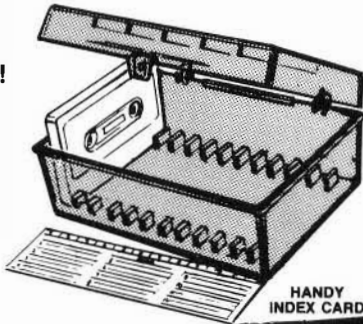

HANDY  
INDEX CARD

**INTRODUCTORY OFFER!**  
ORDER 2 DOZ. CASSETTES, ORDER 1 CADDY  
GET 1 CADDY FREE!  
ORDER 4 DOZ. CASSETTES AND  
2 CADDIES — GET 2 FREE

### HERE'S WHAT USERS SAY ABOUT YORK 10 CASSETTES:

"It's nice to have a tape you can rely on 100% of the time to perform with such quality. And the fast, courteous service was a pleasant surprise."  
Tom Parkinson—Madison, OH

"We monitored the output to the computer with a specially built meter and found absolutely no dropouts throughout the tape . . ."  
Stace Papadopoulos—Beaverton, OR

**"YOU'VE TRIED THE REST, NOW BUY THE BEST"**



FINEST QUALITY  
PHILIPS (NORELCO)  
TYPE HARD BOXES

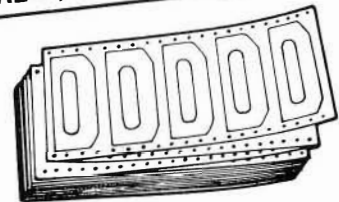

TRACTOR FEED  
DIE-CUT BLANK  
CASSETTE LABELS



**Call: 213/710-1430**  
FOR IMMEDIATE SHIPMENT  
on Credit Card Orders.



**ORDER NOW**  
Mail To . . .

**YORK 10 Computerware**

24573 Kittridge St., #R1 Canoga Park, CA 91307

ITEM	1 DOZEN	2 DOZEN	TOTAL
C-05	<input type="checkbox"/> 7.50	<input type="checkbox"/> 13.50	
C-10	<input type="checkbox"/> 8.00	<input type="checkbox"/> 14.40	
C-20	<input type="checkbox"/> 10.00	<input type="checkbox"/> 18.00	
Hard Box	<input type="checkbox"/> 2.50	<input type="checkbox"/> 4.00	
Storage Caddy @ \$2.95 ea.: Quantity: _____ FREE: Quantity: _____			
Blank labels	<input type="checkbox"/> 4.00/100	<input type="checkbox"/> 30.00/1000	
<b>SUB TOTAL</b>			
Calif. residents add 6% sales tax			
Shipping/handling 1 doz. \$2; 2 doz. \$3.50; 3 doz. \$4.50; each additional doz. \$.50.			
For Parcel Post instead of UPS ADD \$1			
Outside Continental USA, ADD \$2			
<b>TOTAL</b>			

Each cassette includes two YORK 10 labels only. Boxes are sold separately. Shipments are by U.P.S. unless Parcel Post requested. Boxes, caddies, and blank labels are free of shipping charges when ordered with cassettes. When ordered without cassettes, shipping charges: Boxes—\$1.00/doz., Caddies \$1.00 each. MINIMUM SHIPPING/HANDLING ON ANY ORDER—\$2.00.

Check or M.O. enclosed  Charge to Credit Card:  VISA  MASTERCARD

Card No. \_\_\_\_\_ Exp. \_\_\_\_\_

Name \_\_\_\_\_

Address \_\_\_\_\_

City \_\_\_\_\_ State/Zip \_\_\_\_\_

Signature \_\_\_\_\_

Computer make & model \_\_\_\_\_ Disk?(y/n) \_\_\_\_\_

CHECK HERE FOR QUANTITY DISCOUNTS PRICE LIST

```

470 POKE65494,0
480 MOTORON
490 FORDL=33TO255:PRINT@0,CHR$(D
L);:FORD2=@TO5:NEXTD2:NEXTDL
500 CSAVEM"DRAWINGS",1056,1535,4
0999
510 SOUND1,1:GOTO70
520 POKE65494,0
530 PRINT@0,"loading";
540 CLOADM"DRAWINGS"
550 SOUND5,1:GOTO70
560 CLS
570 PRINT"      JOYSTICK/KEYBOARD
DRAW"
580 PRINT"      BY AARON FRANSE
N"
590 PRINT:PRINT" THIS IS A DRAWI
NG PROGRAM"
600 PRINT" WHICH UTILIZES THE KE
YBOARD"
610 PRINT" OR THE JOYSTICK TO MO
VE A"
620 PRINT" COLORED DOT AROUND TH
E "
630 PRINT" SCREEN."
640 PRINT:PRINT" \\PRESS ANY KEY
TO CONTINUE//"
650 IF INKEY$=""THEN650
660 CLS
670 PRINT" HERE IS A LIST"
680 PRINT" OF THE COMMANDS : "
690 PRINT:PRINT" ARROW KEYS -- M
OVE DOT IN          D
IRECTION OF         A
RROW."
700 PRINT" 'S' KEY    -- SAVES D
RAWING              TO TAPE
."
710 PRINT" 'L' KEY    -- LOADS D
RAWING              FROM TA
PE."
720 PRINT" NO.0 TO 8  -- CHANGES
COLOUR              OF DOT.
'0' IS              'BLACKO
UT'DOT."
730 PRINT:PRINT" \\PRESS ANY KEY
TO CONTINUE//"
740 IF INKEY$=""THEN740
750 CLS
760 PRINT:PRINT" 'J' KEY    -- C
HANGES CONTROL     O
F THE DOT TO       T
HE JOYSTICK."
770 PRINT" 'K' KEY    -- CHANGES
CONTROL             OF THE
DOT TO              THE ARR
OW KEYS."
780 PRINT" clear KEY  -- CLEARS
SCREEN."
790 PRINT" FIRE BUTTON-- CLEARS

```

```

SCREEN."
800 PRINT:PRINT" THE HORIZONTAL
AND VERTICAL       LOCATIONS ARE P
RINTED AT THE     TOP OF THE SCRE
EN."
810 PRINT:PRINT" \\PRESS ANY KEY
TO CONTINUE//"
820 IF INKEY$=""THEN820
830 CLS
840 PRINT
850 PRINT" YOU WILL REQUIRE A BL
ANK TAPE TO SAVE THE DRAWN PIC
TURE TO TAPE. WHEN YOU PRESS
THE 'S' KEY, HOLD ON IT UNTIL
YOU SEE CHARACTERS BEING GENE
RATED AT THE TOP LEFT OF TH
E SCREEN."
860 PRINT:PRINT" THE PROGRAM USE
S 64 BY 32        LOW RESOLUTION
GRAPHICS,         ALTHOUGH THE CO
LOURS CAN         BE QUITE DAZZLI
NG AND REAL-     ISTIC."
870 PRINT" 'R' KEY -- RELOCATES
DOT."
880 PRINT" ++PRESS ANY KEY TO
BEGIN++"
890 IF INKEY$=""THEN890
900 GOTO30

```



## Back Issue Availability

Back copies of many issues of *the RAINBOW* are still available.

All back issues sell for the single issue cover price—which is \$2 for copies of Volume 1, Numbers 1-8 (through February, 1982), \$2.50 for Volume 1, Numbers 9, 10 and 12 (through June except May, 1982) and \$2.95 for those issues thereafter. In addition, there is a \$3.50 charge *per order* for postage and handling if sent by United Parcel Service and \$6 for orders sent U.S. Mail. UPS *will not* deliver to a post office box or to another country. This charge applies whether you want one back issue or all of them.

Most back issues are available on white paper in a reprint form. Issues out of print include May, July, August, September, October, November, and December, 1982 and January, February, 1983. VISA, MasterCard and American Express accepted. Kentucky residents please add 5 percent state sales tax.

Due to heavy demand, we suggest you order back issues you want now while supplies last.

In addition, copies of the cover *only* of the July, 1982, Anniversary Issue are available separately for \$1 each, plus 50 cents shipping and handling. These are suitable for framing.

# JUST GOOD SOFTWARE

**DISK DOUBLE ENTRY** - If you have spent hours trying to balance your Debits and Credits, this program is for you! Designed for small business, club, and personal use. Enter transactions in a journal type format. Program will maintain current account balances, produce Trial Balance, Income, and Balance Sheet reports and complete Account Ledgers. Will handle up to 300 accounts including report headings and totals. Up to 1400 average transactions on a diskette. Summary reports and four levels of subtotals available. **REQUIRES 32K** and a user understanding of standard double entry accounting concepts. - \$44.95 in BASIC with Machine Language subroutines.

**DISK DATA HANDLER** - Will allow you to design disk data files for your specific applications. Provides a powerful facility for on-screen input and update, fast selection and sorting, user defined output of reports to screen or printer, and output to disk files which may be read by your BASIC programs for any computational or special formatting requirements. You define a basic record of up to 14 fields and 246 characters. Sort or select records based on any field or combination of fields in this record. Maximum number of records you may work with at one time will depend on record size (500 - 23 char records, 50 - 246 char records). An optional Extended record linked to the basic record may also be defined. The size of the Extended record is not a factor in determining maximum number of records. Disk Data Handler is the type of tool which will provide the growth capability needed for your increasingly sophisticated applications. **REQUIRES 32K**. - \$44.95 in BASIC with Machine Language subroutines.

**NOW** - Also available in a **64K** version. More than three times the number of records shown above **plus** enhanced performance and report formatting capabilities. Uses standard ROM's - No special operating system required!  
**DISK DATA HANDLER - 64K - \$54.95**

**DATE-O-BASE CALENDAR** - Puts you in charge of your schedule! Graphically displays any monthly calendar between 1700 and 2099. You put in up to twelve 28 character memos per day - calendar shows where the memos are - call up of day shows details. Use for appointments and a log of past activity. Study the chronology of the American Revolution or note the day your mortgage will be paid off. Search capability allows you to list or print all memos between two specified dates or only ones meeting key word criteria. Date computation shows elapsed time between two dates in days, weeks, months, and years. **REQUIRES 32K** in BASIC.

**TAPE DATE-O-BASE CALENDAR - \$16.95**  
(max. 400 memos/tape file)

**DISK DATE-O-BASE CALENDAR - \$19.95**  
(over 4,000 memos/disk - max. 300 memos/month)

**MATH TUTOR** - Five programs that go from math fact (+, -, X, /) drill to full addition, subtraction, multiplication, and division at four levels of difficulty. Provides a step by step approach with error correction and rewards for good performance. - \$13.95 in BASIC.

**SPELLING TEACHER** - Up to 200 of their spelling words stored on tape or disk are presented in four lively study modes including a scrambled word game. - \$12.95 in BASIC.

**ALPHA-DRAW** - A subroutine designed to let you easily add characters to your graphic displays. You define X and Y coordinates and a string variable of one or more characters and Alpha-Draw will do the rest. Includes all keyboard characters. Comes with instructions for a true line numbered merge of tape files. Works great with the Screen Print program! - \$8.95 in BASIC.

**GRAPHIC SCREEN PRINT PROGRAM** - Works in ALL PMODES and lets you shift screen image anywhere on the printed page. Relocatable code lets you use all of your 16K or 32K machine. Available for both Color Basic 1.0 and 1.1. Use EXEC 41175 to see which you have and SPECIFY with order. In Machine Language.

\$7.95 - For TRS-80® LP-VII/VIII & DMP 100/200/400

\$9.95 - For Epson GRAFTRAX®, PROWRITER®, NEC® PC 8023A-C (specify printer type)

Microline® 82A/83A (with OKIGRAPH® I), Microline 84

IDS-440/445, Paper Tiger® 460/560, Prism® 80/132 (with dot plotting)

(Trademarks of Tandy Corp., Epson America, Inc., C-Itoh, NEC America, Okidata Corp., Integral Data Systems, Inc.)

ALL PROGRAMS require Extended Color Basic and are delivered on cassette. All, except Tape Date-O-Base Calendar, are DISK System compatible.

*We want your  
SUGGESTIONS!*

## Custom Software Engineering, Inc.

807 Minutemen Causeway (D-2), Cocoa Beach, Florida 32931  
(305) 783-1083



For VISA and Master Card orders:  
Include type, account number, expiration date, signature and phone number.  
Sorry! No COD's.

Add \$1.00 per order for shipping. Florida residents add 5% sales tax. Return within two weeks if not completely satisfied.



**RAINBOW  
CERTIFICATION  
SEAL  
ALL LISTED  
PROGRAMS**

\*RAINBOW  
REVIEW DATES  
\*JAN '83

\*OCT '82

\*JUNE '82

\*SEP '82

\*SEP '82

\*AUG '82

\*MAY '82



## Remote Interest Quickens with *Remoterm*

What do you do on your lunch hour? Well, depending on how much time you have, or maybe depending on whether you have a terminal at your disposal, you can talk to your CoCo at home. Star-Kits has come up with another gem of a program in *Remoterm*. This program allows you to control and run your TRS-80C from a remote terminal or a modem.

*Remoterm* comes on cassette or disk. More than adequate information on its proper operation is given in the 10-page manual. To summarize, after loading the program at the memory location of your choice, it's in position independent code—the TRS-80C is controlled by both the keyboard and the RS-232 port. At the same time all output goes to the screen and the RS-232 port. The program is written in machine code and will run in 4K, although 16K is recommended. Operation is at 300 baud; higher baud rates are mentioned but not recommended.

Well, I guess you're thinking along the same lines as I was: this is great, but there are limitations. As the manual explains, during remote operation there is no way to hit the reset key for a hung-up program. A control-C from the remote terminal will simulate the break key. Maybe the modem you are using has this facility but be careful. The

other problem was discovered quite by accident. I was using a terminal in the same room and tried to load a machine language program from tape. It just so happened that the program was at the same address as *Remoterm* and completely wiped it out, hanging-up the computer. My mistake, but something to remember.

There are several other uses for this program besides remote operation of the computer. Those of you who prefer a professional keyboard while using a word processor will find *Remoterm* the answer. For the same reasons, you may want a screen display different than 32 x 16, even though some other software is available for this purpose. Obviously, no graphic screens are available on the remote terminal and care must be exercised with program selection as various graphic commands will not work through a serial interface.

In summary, I recommend *Remoterm* to anyone interested in remote operation of the CoCo, for whatever purpose. The program does exactly what it is supposed to do. The documentation is excellent, complete with a commented listing of the source code. I would recommend that if remote operation is contemplated, a disk system is almost a necessity due to the mechanics of tape files. I found the program both interesting and valuable.

(Star-Kits, P.O. Box 290-R, Mt. Kisco, NY 10549, \$19.95  
on tape or disk)

—Dan Downard

# TALK IS CHEAP.

You want your color computer to talk, but how much will it cost?

\$50? \$100? \$200? No.

## \$29<sup>95</sup>?

Yes! **SPEAK UP!**<sup>™</sup> from  
*Classical Computing, Inc.*  
is a machine language

Voice Synthesizer program for your TRS-80 Color Computer.\* It is 100% software. Nothing else to buy. Best of all, YOU CAN MAKE BASIC PROGRAMS TALK! It's easy to use, and will say virtually anything.

**SPEAK UP! For \$29.95.**

**Talk really is cheap!**

*Classical Computing, Inc.*  
P.O. Box 12247  
Lexington, Kentucky 40582



\*T.M. Tandy Corp.

16k minimum



# Color Computer Collection For Your TRS 80



## WICO COMMAND CONTROL JOYSTICKS...ALL 10% OFF!

### WICO COMMAND CONTROL Joystick

The ultimate in one-hand control. The bat handle grip fits comfortably in your hand and offers smooth, quick 8-position movement. Two fire buttons, one on the handle, the other on the base, make this a most versatile unit. And the rugged, compact base gives you a feeling of total control, while the 4 rubber grip pads make it ideal for table-top. Yet it's lightweight enough for hours of comfortable hand-held action. Most important, there's WICO's 6-leaf switch assembly — the key to a new dimension of arcade response and control.

With appropriate WICO adaptor, will interface with Radio Shack TRS80 Color Computer.

**\$29.95 (on sale now through April 30 for \$26.95)**

WICO COMMAND CONTROL ADAPTORS are available for each joystick hook-up to Radio Shack Color Computer.

Radio Shack TRS80 Color Computer Adaptor

**\$17.95 each (on sale now through April 30 for \$16.15)**



### WICO COMMAND CONTROL NEW FOR 1983 ANALOG JOYSTICK

Analog style joystick with two fire buttons now available for direct use with TRS80 Color Computers.

**\$49.95 (now on sale through April 30 for \$44.95)**



### WICO COMMAND CONTROL TRACKBALL

Increase the response...the challenge...the fun of home video games. A phenolic ball offers the magic of 360 degree movement to an infinite number of positions, and controls the speed of the objects on the screen, as well. It's the same design that WICO sells to the arcade market! One fire button and 1 computer connection cord. For direct use with Radio Shack TRS80 Color Computers.

**\$69.96 (now on sale through April 30 for \$62.95)**



### WICO COMMAND CONTROL JOYSTICK EXTENSION CORDS

For use with all Command Control joysticks and adaptors, allow you to move freely about as you play your favorite games.

**Six Foot Length, \$4.95 (on sale now through April 30 for \$4.45)**

**Twelve Foot Length, \$7.95 (on sale now through April 30 for \$7.15)**

Over 1500 Programs for TRS-80,

ATARI 400/800, APPLE & IBM.

For Information Call  
202-363-9797

THE PROGRAM STORE T.M.

To Order Call Toll-Free  
800-424-2738

Visit our other stores:  
829 Bethel Rd., Columbus OH  
Seven Corners Center, Falls Church, VA  
W. Bell Plaza, 6600 Security Blvd., Baltimore, MD  
White Flint Mall, Rockville Pike, Rockville, Md.

MAIL ORDERS: Send check or M.O. for total purchase price, plus \$2.00 postage & handling. D.C., MD: & VA: add sales tax. Charge cards: Include all embossed information.

© 1982 The Program Store, Inc.



THE PROGRAM STORE • Dept. 24-03-3 • Box 9582 • 4200 Wisconsin Avenue, N.W. • Washington, D.C. 20016

Item	Tape/Disk/Book	Price	Postage \$2.00	Name _____
_____	_____	_____	Total _____	Address _____
_____	_____	_____	<input type="checkbox"/> CHECK <input type="checkbox"/> VISA	City _____ State _____ Zip _____
_____	_____	_____	<input type="checkbox"/> MASTERCARD	Card # _____ Exp _____
_____	_____	_____	Computer _____	

## Preread Series is Good Head Start Program

If you have a young child you would like to see receive a head start in reading, *Preread* by Prickly-Pear Software is an excellent tool with which to begin. Three programs are contained in the *Preread* package. They can teach the young child from three years up important letter recognition.

*Preread 1* presents the names of the letters of the alphabet auditorially (by voice on tape) and asks the learner to press the letter on the keyboard which corresponds with the letter name. The voice is pleasant and nonthreatening.

*Preread 2* presents the sounds of the letters of the alphabet in the context of words and asks the learner to press the key which corresponds to the sound which that letter makes. Vowel sounds are short and those letters (such as c and g) which have two sounds are prompted with the "hard" sounds. The letter "X" is presented as the "K" sound at the end of the word "box." The Q sound is presented as the first of the two letters at the beginning of the word "quiet." The sounds are presented out of sequence.

*Preread 3* flashes random letters visually at the rate of one-fourth, one-half, or one full second. This rate is preselected. The learner is then to respond by pressing the correct key which corresponds to the letter he or she has just viewed on the screen. You select the number of letters you want the learner to view.

If the learner presses the correct key in any program, a Happy Face appears on the screen. Next the correct letter is graphically presented in both upper and lower case.

In *Preread 1 and 2*, an incorrect key press brings a Sad Face to the screen. Next, the correct letter is graphically presented on the screen. This flashes three times while the sound which accompanies a correct response is repeated. Another sound is used when an incorrect response is given; this allows the parent or teacher to auditorially monitor the learner's progress.

In *Preread 3*, an incorrect response is followed by the same Sad Face, but the letter is repeated until the learner makes the correct response.

The *Preread* package is an excellent group of programs, which a child of three years up to age six would benefit from. It is well documented, with the exception of loading procedures, which should be separated from the text. My son, a kindergartner, thoroughly enjoyed all three programs. They keep the child's interest and are viewed as a game, not a test, although a percentage score is given at the end of each program.

All programs give the learner unlimited time to find the letter asked for, but the original question is not repeated, thus encouraging the child to develop good listening and attention spans.

One additional comment—several of the letter shapes, V and W especially, were confusing to the young learner.

(Prickly-Pear Software, 9822 E. Stella Road, Tucson, AZ 85701, \$24.95)

—Pamela Peitsch

# VOICE RECOGNITION

For your 16K TRS-80 Extended Basic Color Computer

Using your cassette recorder's condenser microphone, the *COLOR TALK TO ME* software package can let you use your own voice as an alternate means of input for any of your BASIC programs. Over 200 words can be stored in 16K RAM. With a little practice, you can attain from 80% to over 90% accuracy for most applications.

The *COLOR TALK TO ME* Software Package includes:

- COLOR TALK TO ME* machine language subroutine
- The BASIC subroutine which can merge *COLOR TALK TO ME* with your programs
- Complete instructions on how to use and incorporate *COLOR TALK TO ME* in BASIC programs

-Two application programs:

1. *VOICE CALC*- Use your voice to enter arithmetic problems and *VOICE CALC* will display the solution.
2. *SCREEN PAINTER*- Say a color and the screen will be painted that color.

ALL OF THIS ON TWO CASSETTES FOR ONLY \$49.95!!!

ColorSoft Software will soon be releasing voice recognition programs which can be used once you buy *COLOR TALK TO ME*. Coming soon: *Connect More*, *Crosswords* & more!

ATTENTION PROGRAMMERS: ColorSoft Software will market original voice recognition programs using *COLOR TALK TO ME* with excellent royalties in return.

Dealer  
Inquiries  
Invited

Send check or money order to: ColorSoft Software Co.  
Add \$2.00 shipping 11764 Raintree Ct.  
MI residents add 4% sales tax Utica, MI 48087

## Inspector Cluseau Is Not Elementary, Sherlock

*Inspector Cluseau* is a mystery game that would tax the deductive reasoning power of Sherlock Holmes. Mr. Goodbody has been murdered and you must solve the mystery. You must discover who committed the murder, the weapon used and in what room the crime occurred. Solving the mystery will not be easy because there are six suspects, eight possible weapons and nine rooms in the mansion.

You will have seventy-five game turns to solve the mystery. Each game turn will randomly place you in a room of the mansion with one randomly selected suspect. A hi-res graphic display will show your location in the mansion. You will have a choice of questioning the suspect, searching for a secret passage, or making an accusation.

Most of the information used to solve the mystery will be derived from questioning the six suspects. You can't trust all of the suspects! Miss Violet might lie or change her mind and Mr. Denton lies all the time.

Each game will have one randomly selected room with a secret passage. Upon entering a new room, search for the secret passage. If you are in the correct room, a secret door will open allowing you to enter a hidden chamber. You will

be given a four letter code to solve. If you successfully solve the code within the allotted ten tries you will receive a CLUE or the message "Clues are getting scarce—try again." You will be returned to the game board after ten unsuccessful tries. One game turn is used each time you search for the secret passage.

You only have one chance to make a correct accusation. If you are wrong you will be given the correct suspect, weapon and room.

The instructions are clearly written and accurate. *Inspector Cluseau* is easy to play, but not necessarily easy to win. Hi-res graphics are used throughout most of the game. I especially liked the use of the hi-res alphanumerics. My wife enjoyed the secret door graphic and sound routines.

*Inspector Cluseau* uses the Auto Run program (copyright Sugar Software). There are some *POKE 65495,0* and *POKE 65494,0* commands used in the program to speed up and slow down computer operation. The speed up command can't be handled by some CoCo's. The Auto Run program prohibits the editing of the *POKE 65495,0* statements. A version of *Inspector Cluseau* could be sold without the speed up *POKE* statements.

Anyone who enjoys adventure or mystery games will have lots of fun playing *Inspector Cluseau*. This game will fine tune your deductive reasoning skills.

(Petrocci Freelance Associates, 651 N. Houghton Rd., Tucson, AZ 85710, \$19.95 32K ECB tape only)

—Gabe Weaver

**NEW!** From **GREAT X·P·T** for TRS 80 Color Computer

# MISSILE BARRAGE

Color Sound  
High Res. Graphics  
Req. 16k Ext Basic  
\$10.95ea.



GREAT X·P·T

P.O. Box 9212  
Livonia, Mi. 48150

CRAPS

BOXCARS



GREAT X·P·T

**FOR THE GAMBLER**  
16k Ext Basic  
High Res. Graphics  
Play Alone  
or Against  
Your Friends  
\$10.95 ea.

SEA BATTLE



GREAT X·P·T

16k  
Color  
Sound  
Graphics  
\$10.95ea.

FREE CATALOG AVAILABLE

HOLIDAY SALE... ALL THREE FOR \$ 25.95

TRS 80 IS A T.M. OF THE TANDY CORP.



## Monitor What is It? Who Needs It?

By Sue Searby

A "monitor" is not always just the kid in charge of checking the balls out and in for recess! In "computerese" the word "monitor" has taken several new meanings.

First, monitor can mean a video screen that hooks to a computer much like a TV on which the computer displays its information. This use of "monitor" could be replaced by the term, "CRT," or screen. The other use of "monitor" in computer jargon is less concrete and we will concentrate on it.

A monitor is a program, software, that communicates directly between you (the user) and the computer (CPU and memory). Like the elementary school's ball monitor, it has the responsibility of "go-between."

When the user types in one of the monitor's commands, the monitor will go to the computer's CPU or memory, fetch the information, and display it on the screen for the user to see. The monitor also has commands to tell the CPU to do something to change values in the memory.

In summary, the monitor is a "low level" communicator program between the user and the computer. Below are some example monitor commands and functions.

- A - Examine and change A register
- F - Find a byte string
- G - Go to user's program
- I - Initialize memory
- J - Jump (subroutine) to address
- K - Set breakpoint
- M - Memory examine and change

- L - Binary load from cassette
- S - Binary save to cassette
- T - Text input to memory
- V - Set breakpoint and begin execution
- W - Warm start into BASIC
- Z - Display formatted memory dump

Who needs or uses a monitor program? A programmer who does machine language or assembly language programming uses the monitor to test his programs and learn about the internal operations of the CPU chip and the memory. Most users or even BASIC programmers do not have a need for a monitor program. Some companies who sell monitor programs use the rule, "If you don't know what a monitor is, you do not need one." Of course, even though you know what a monitor is, you need not assume you need one. And conversely, just because you don't need one does not imply you do not WANT one! A monitor is a very powerful and useful tool for those who are serious about learning the "nitty gritty" about computers and assembly language programming. And isn't this what it is all about—learning about this new technology? So do not be afraid to venture out, make mistakes, and learn new things either with a monitor program or with some other new concept you encounter.

*(Ms. Searby is a principle in Computerware, which publishes a number of monitor programs for the Color Computer.)*



### ARE YOUR WALKING FINGERS GETTING FOOTSORE ?

Tired of typing in those long, but wonderful, programs from each issue of **the RAINBOW**? Now, you can get **RAINBOW ON TAPE** and give those tired fingers a rest. With **RAINBOW ON TAPE**, you'll be able to spend your time enjoying programs instead of just typing...typing...typing them! All you need to do ever again is pop a **RAINBOW ON TAPE** cassette into your recorder. CLOAD and RUN any one you want.

**RAINBOW ON TAPE** is available as a single issue for \$6.50 or on a yearly subscription basis for only \$60. It is the perfect complement for **the RAINBOW** itself.

VISA, MasterCard and American Express accepted. All subscriptions begin with the current issue and back issues are available beginning with April, 1982. Subscriptions are sent first class mail to coincide with the arrival of your current issue of **the RAINBOW**.

**The RAINBOW**  
9529 U.S. Highway 42  
P. O. Box 209  
Prospect, KY 40059

YES! Sign me up for **RAINBOW ON TAPE**. I want:

A Full Year for \$60       A month for \$6.50 (Specify Month \_\_\_\_\_)

Name \_\_\_\_\_

Firm Name \_\_\_\_\_

Address \_\_\_\_\_

City \_\_\_\_\_ State \_\_\_\_\_ Zip \_\_\_\_\_

Payment Enclosed     Charge my VISA account     Charge my MasterCard account     Charge my American Express account

Account # \_\_\_\_\_ Signature \_\_\_\_\_ Card Expires \_\_\_\_\_ Interbank # \_\_\_\_\_

RAINBOW CONNECTION SOFTWARE presents...



5 soundational, colorful, graphic games for your Color Computer including: Brickout, B-17 Bomber, Blackjack, Jackpot and Computation - all for the price you might expect to pay for just one of these games!!! Plus added bonus - Compumind; guess the computer's secret code from clues provided - a game of logic for the whole family. At this price can your library afford to be without them?

All machines - Ext. Basic NOT Required  
\$19.95 Cassette - \$24.95 Disk

RAINBOW CONNECTION SOFTWARE presents...

# CONQUEST OF KZIRGLA



You've traversed the dungeons of Kzirgla and reclaimed the almighty Scepter. Now you must use its invincible powers and all your weapons to slay a myriad of monsters and fireballs in your attempt to destroy the evil wizard. If you like the challenge and mystique but not the boredom of text only adventure games then this real time, hi-res sequel to the ever popular Scepter of Kzirgla is for you!

CONQUEST OF KZIRGLA for the Color Computer

16K Ext Basic Cass - \$21.95  
32K Diskette - \$26.95

RAINBOW CONNECTION SOFTWARE presents...

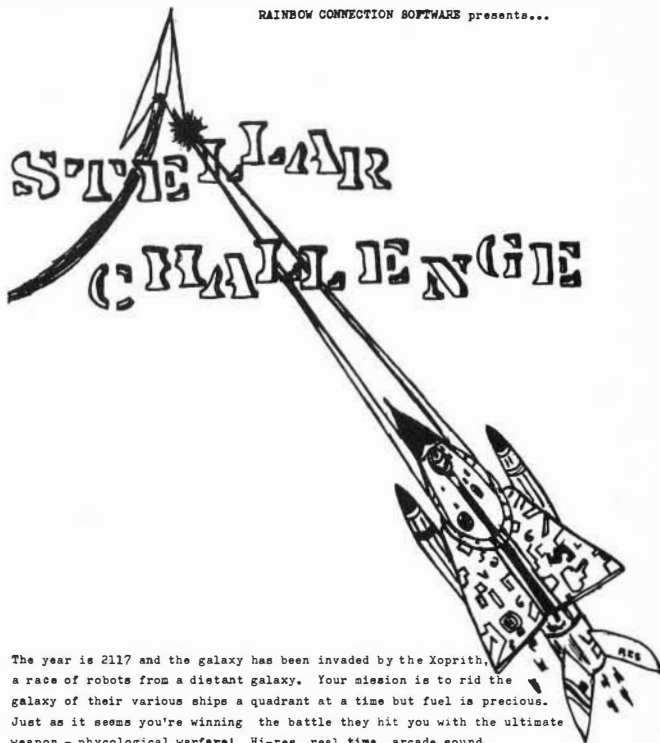

The year is 2117 and the galaxy has been invaded by the Xoprith, a race of robots from a distant galaxy. Your mission is to rid the galaxy of their various ships a quadrant at a time but fuel is precious. Just as it seems you're winning the battle they hit you with the ultimate weapon - psychological warfare! Hi-res, real time, arcade sound.

16K Ext. Basic & Joystick  
\$14.95 Cass

# SCEPTER OF KZIRGLA



RAINBOW CONNECTION SOFTWARE presents...



At last...a real-time graphics adventure game with arcade sound for your Color Computer! If you are bored with silent screens of text but enjoy the challenge and complexity of adventure games then SCEPTER OF KZIRGLA is for you.



16K Ext. Basic Req.  
\$16.95 cass - \$21.95 disk

Include \$2.00 shipping.  
Minn. residents add 5% tax.  
Dealer inquiries invited.



RAINBOW CONNECTION SOFTWARE  
3514 6th Place N.W.  
Rochester, MN 55901

Not affiliated with THE RAINBOW.

## Green On Black Video: 'Eye Friendly' Conversion

By Tony DiStefano

It's two o'clock in the morning and you are typing away on your TRS-80 Color Computer. Your eyes are burning because you've been staring at that bright green screen trying to create your "Do everything program" for hours. So you turn down the color, contrast and brightness of the display but that doesn't help too much. It's still a big square of light. Well...what can you do? Follow these simple instructions and when you are finished you will have a reversed screen like mine.

Though these instructions are simple, only those with soldering experience should attempt this project. You will need a Phillips screwdriver, a grounded soldering iron, solder, an IC extractor, two pieces of thin wire, flux cleaner, and a little patience. And, if you haven't received the warning before, opening your computer may void your warranty.

Before you start tearing into your computer, a bit of background on the VDG (Video Display Generator) is in order. The VDG is a large scale integrated circuit (LSI) chip

that takes care of all the video you see on the screen, be it Alphanumeric or full graphic. The VDG continually scans memory (Via the SAM) and displays what it sees. In the Alphanumeric mode it converts the ASCII code of a byte of memory into a graphic block that looks like the letter it represents. Normally an upper case letter or number is black with a green background. Lower case letters are the opposite, green with a black background. What my circuit modification does is reverse the order so that upper case letters are green with black background and lower case letters are black with green background. This does not change anything in memory nor does it interfere with BASIC. It also does not change any graphic modes or color. Everything stays the same except the letters, numbers and symbols. The diagrams in this article pertain to most versions of the computer. Version 1.1, 1.0, 4K, 16K, 32K, 64K, BASIC, Extended BASIC, and even Disk BASIC are OK. The only version of which I cannot say "it works" is the newest version, the one with the power supply in the bottom left hand corner. It should be the version "F" but it is not written anywhere on the board.

Before you start into this, make sure that you have a large clean work space. Make sure the computer is not plugged in.

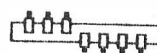

FIG-1

Put the computer upside down on a soft surface. Unscrew the seven screws that hold the cover on. If you haven't opened it before, the seventh screw is under the black sticker that warns you not to open this thing. Turn the unit over again (top side up) and pick up all the screws that fall out. Put them aside in a safe place. Remove the top cover and put that away, too. Lean forward slightly and gently pull up on the keyboard. Unplug the connector that ties the keyboard to the main board. Put the keyboard aside. Now cut the two tie wraps that hold the RF shield in place. That's the big square piece of metal with holes in it. Remove the RF shield and put it with the other parts. You are now ready for part two.

Before you start part two, let me tell you that the board is very sensitive to static electricity. Try to avoid dry areas and avoid touching the contacts on the board whenever possible. OK, let's get going. Locate and pull out the 74LS02 IC marked U29 on the PC board. Carefully bend pins 1, 2 and 3 so they stand straight up in the air upside down. The dot denotes pin #1. If you are facing the computer it is the top left hand corner. See Figure 1. Now solder one end of a four-inch piece of wire to pin #1 of the IC. The best wire to use is a #28 or #30 Wire Wrap wire. Solder another piece of six-inch wire to pins 2 and 3. Yes, both pins together. Now put the IC back in the socket. Make sure it is in the right orientation. The dot should be in the upper left hand corner. Also make sure that the wires and the pins do not touch the side of the RF shield. Now carefully remove the MC6847 IC marked U7 on the PC board. Bend pin #32 outwards just enough so that when you replace it, it does not go into the socket. Replace the MC6847. Again, make sure of the orientation. The dot should be in the upper right hand corner. Take the other end of wire that connects to pin 1 of the 74LS02 and solder it to pin 32 of the MC6847. Take the other end of wire that connects to pins 2 and 3 of the 74LS02 and solder that to

### COLOR COMPUTER SOFTWARE

#### Adventure games

- **THE ALCHEMIST'S LABORATORY - \$14.95**

mix the ingredients that will  
turn lead into gold.

- **LOKAR'S MAGIC STAFF - \$14.95**

can you unlock the deadly secrets of LOKAR'S magic staff?

- **MEGAMAZE - \$14.95**

a wild, five dimensional space maze adventure.

- **SQUEEZE - \$14.95**

arcade style game where aliens close in from both sides at once.

- **GRAPHIC SCREEN EDITOR - \$16.95**

create pictures on the screen using joysticks or arrow keys—save on tape, erase, paint, and many other features.

- **COLOR SHOW DISPLAYS - \$8.95**

five graphics programs that create endless changing patterns.

all programs 16-K extended basic cassette only.

Send for free catalogue. We accept checks, money orders, Visa and Mastercharge. (no C.O.D.'s) Please add \$1.00 for shipping. Send to:

**REAL SOFTWARE CO.**

**P.O. BOX 401 ● HOPEDALE, MA 01747**

**(617) 393-6281**

CIS orders EMAIL to 71505,430

Mass. residents add 5% sales tax

Dealer inquiries welcomed

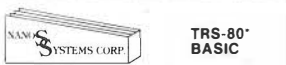

TRS-80<sup>®</sup> BASIC

LEVEL II SYSTEM REFERENCE CARD MODEL I



TRS-80<sup>®</sup> BASIC AND ASSEMBLER

LEVEL II SYSTEM REFERENCE CARD MODEL I

DECIMAL	HEX	DESCRIPTION
0	0000h	BASIC ROM
1296	3000h	RESERVED
1430	3700h	COMMUNICATION STATUS ADDRESS
1430	3700h	COMMUNICATION DATA ADDRESS
1430	3700h	INTERRUPT LATCH ADDRESS
1430	3700h	DISK DRIVE SELECT LATCH ADDRESS
1430	3700h	CASSETTE SELECT LATCH ADDRESS
1431	3700h	LINE PRINTER ADDRESS
1431	3700h	FLOPPY DISK CONTROLLER ADDRESS
1432	3800h	KEYBOARD MEMORY
1530	3C00h	CRT VIDEO MEMORY
1634	4000h	INTERRUPT ADDRESSES (FOR MS-PCARD)
1640	4010h	KEYBOARD DCB
1641	4010h	VIDEO DCB
1642	4020h	PRINTER DCB
1643	4030h	RESERVED
1644	4040h	IOIC INTERRUPT VECTOR
1648	4060h	COMMUNICATIONS INTERRUPT VECTOR
1648	4060h	RESERVED
1648	4060h	25 MSEC HEARTBEAT INTERRUPT
1652	4080h	BASIC RAM
1680	4150h	IO BUFFER
1718	42E0h	ALWAYS ZERO
1719	42E0h	USER PROGRAM MEMORY
2047	4FFFh	END OF MS SYSTEMS
32767	7FFFh	END OF 1M SYSTEMS
49151	0FFFFh	END OF 32K SYSTEMS
65535	FFFFh	END OF 64K SYSTEMS

MAGIC NUMBER IS 319

128	131	140	145	142	138	178	181	176	148	138	129	136	132	168	144
186	153	158	169	162	154	172	156	157	174	187	155	162	163	182	167
138	122	168	168	162	145	181	148	137	154	152	164	163	147	178	171

NEW! QUICK REFERENCE



TRS-80<sup>®</sup> BASIC AND ASSEMBLER

MODEL II SYSTEM REFERENCE CARD

TR8002 VERSION 2.0 © 1981, SHIRLEY A. & PAUL P. NANOS

TR8002 MODEL II MEMORY MAP

ADDRESS	DEC	HEX	DESCRIPTION
0	0000h	0000h	TR8002
3200	0900h	0900h	High priority command line
3200	3000h	3000h	User program area
7200	1000h	1000h	Expanded to TR8002
32767	7FFFh	7FFFh	End of 32K address
65535	FFFFh	FFFFh	End of 64K address

SCREEN LAYOUT

SAVE TIME!



TRS-80<sup>®</sup> BASIC

LEVEL II SYSTEM REFERENCE CARD MODEL III



TRS-80<sup>®</sup> BASIC AND ASSEMBLER

LEVEL II SYSTEM REFERENCE CARD MODEL III

© 1981, SHIRLEY A. & PAUL P. NANOS

TR8003 is a Registered Trademark of Tandy Corp.

TR8003 MODEL III MEMORY MAP

ADDRESS	DEC	HEX	DESCRIPTION
0	0000h	0000h	TR8003
3200	0900h	0900h	High priority command line
3200	3000h	3000h	User program area
7200	1000h	1000h	Expanded to TR8003
32767	7FFFh	7FFFh	End of 32K address
65535	FFFFh	FFFFh	End of 64K address

SPECIAL CHARACTERS

128	131	140	145	142	138	178	181	176	148	138	129	136	132	168	144
186	153	158	169	162	154	172	156	157	174	187	155	162	163	182	167
138	122	168	168	162	145	181	148	137	154	152	164	163	147	178	171

USE THE CARD!

NEW! THROW AWAY THE BOOK



TRS-80<sup>®</sup> COLOR BASIC AND EXTENDED



SYSTEM REFERENCE CARD

© 1981, PHILIP R. FASSNACHT and SHIRLEY A. & PAUL P. NANOS

TR8004 is a Trademark of Tandy Corp.

TR8004 MODEL IV MEMORY MAP

ADDRESS	DEC	HEX	DESCRIPTION
0	0000h	0000h	TR8004
3200	0900h	0900h	High priority command line
3200	3000h	3000h	User program area
7200	1000h	1000h	Expanded to TR8004
32767	7FFFh	7FFFh	End of 32K address
65535	FFFFh	FFFFh	End of 64K address

MAGIC NUMBER IS 271

128	131	140	145	142	138	178	181	176	148	138	129	136	132	168	144
-----	-----	-----	-----	-----	-----	-----	-----	-----	-----	-----	-----	-----	-----	-----	-----

MAGIC NUMBER IS 303

144	147	156	161	148	148	152	148	174	153	160	165	151	158	157	160
-----	-----	-----	-----	-----	-----	-----	-----	-----	-----	-----	-----	-----	-----	-----	-----

MAGIC NUMBER IS 335

160	163	172	181	162	164	188	183	170	168	168	171	167	174	173	176
-----	-----	-----	-----	-----	-----	-----	-----	-----	-----	-----	-----	-----	-----	-----	-----

MAGIC NUMBER IS 367

178	178	188	177	186	184	181	181	188	181	183	183	183	183	183	181
-----	-----	-----	-----	-----	-----	-----	-----	-----	-----	-----	-----	-----	-----	-----	-----

MAGIC NUMBER IS 399

192	195	204	193	194	196	200	187	202	201	198	203	196	200	205	207
-----	-----	-----	-----	-----	-----	-----	-----	-----	-----	-----	-----	-----	-----	-----	-----

MAGIC NUMBER IS 431

198	211	220	208	216	218	218	213	218	217	214	218	215	223	221	223
-----	-----	-----	-----	-----	-----	-----	-----	-----	-----	-----	-----	-----	-----	-----	-----

MAGIC NUMBER IS 483

224	227	236	225	226	230	233	228	234	233	238	233	231	234	237	238
-----	-----	-----	-----	-----	-----	-----	-----	-----	-----	-----	-----	-----	-----	-----	-----

MAGIC NUMBER IS 495

240	243	252	241	242	246	249	245	248	244	251	248	254	247	254	255
-----	-----	-----	-----	-----	-----	-----	-----	-----	-----	-----	-----	-----	-----	-----	-----

USE THE CARD!

MODEL I

MODEL II

MODEL III

COLOR

**BASIC: Buff & Blue 5 Panels, 10 Pages (For the Classroom)**  
Memory Map.  
Easy Graphics.  
Basic Statements.  
Basic Functions.  
Basic Facts.  
Special Characters.  
Basic Commands.  
Edit Subcommands.  
PRINT USING Examples.  
Message & Codes.  
Reserved Words.  
Special Keys.  
Ascii Character Chart, with Space Compression Codes.  
Control Codes.  
Basic Internal Codes.  
Hex/Dec Conversion Chart.  
Screen Line Layout.  
**BASIC & ASSEMBLER: Buff 8 Panels, 16 Pages (For the Pro)**  
Complete 280 Instructions.  
Assembler Instructions.  
Commands, Operators.  
Editor/Assembler Commands, and Edit Subcommands.  
Flags, Conditions, & Chart.  
Internal Routines.  
Assembler Error Msgs.  
Plus all items in the Basic Card, except Internal Codes.

**BASIC & ASSEMBLER: Green 10 Panels, 20 Pages (For the Business)**  
Small Memory Map.  
Screen Layout.  
Easy Graphics.  
Complete 280 Instructions.  
Series-I Assembler Instr.  
Commands, Operators, and Edit Subcommands.  
Assembler Error Msgs.  
Power-up Error Msgs.  
Flags, Conditions, & Chart.  
Wild Cards, DOS Messages.  
SVC Procedure Panel.  
Host Logon Panel.  
Version 2.0 Lib Command Formats and System Utility Formats.  
Basic Functions & Statements.  
DOS File Naming Convention.  
Basic Commands & Edit Subcommands.  
Special Keys.  
Basic Internal Codes and Reserved Words.  
Basic Msgs & Codes.  
PRINT USING Examples.  
Special Characters.  
"DO" Utilities & BASIC Command.  
Ascii Character Chart with SVC Names and Numbers.  
Control Codes.

**BASIC: Blue & Buff 6 Panels, 12 Pages (For the Classroom)**  
Special Characters.  
Kana Characters.  
Euro-Characters.  
Memory Map.  
Special Keyboard Functions.  
Ascii Char Chart w/Space Compression Codes.  
Control Codes.  
Cassette Loading Err Msgs.  
Basic Commands, Edit Subcommands, Special Chars, Basic Statements, Facts, Functions.  
Derived Functions, Special Operations (POKES).  
PRINT USING Examples.  
Basic Msgs & Codes.  
Basic Internal Codes.  
Reserved Words.  
Screen Line Layout.  
**BASIC & ASSEMBLER: Blue 10 Panels, 20 Pages (For the Pro)**  
Complete 280 Instructions.  
Assembler Instructions, Commands, Operators.  
Series I Editor/Assembler Commands & Edit Subcommands.  
Flags, Conditions, & Chart.  
Hex/Dec Conversion Chart.  
Assembler Error Msgs.  
Internal CALL Routines.  
Break Processing Procedure.  
Plus all items in the Basic card.

**BASIC & EXTENDED: Grey + 9 Colors. 8 Panels, 16 Pages (For the Artist)**  
All Color Graphics.  
System Commands.  
PRINT USING Examples.  
Special Characters.  
Special Keys.  
Cassette Loading Err Msgs.  
Basic Functions & Statements.  
Playing Music, Making a Circle, and Drawing Panels.  
Derived Functions.  
Messages & Codes.  
Musical Notes, by Octave, in Color, including Rests and Time.  
Memory Map.  
Reserved Words.  
Internal Codes.  
A Page of Tips.  
Ascii Char Codes Chart, including Inverse Graphics and Color Graphics.  
Control Codes.  
Color Group Chart.  
Pmode Information Summary.  
Screen Line Layout.  
Extended Graphics Pmode Illustrations.

Each card is a complete summary of the reference manuals and the microcomputer. Cards are two or more colors, printed on 80 pound Beckett Antique cover stock or a comparable stock, stretch-wrapped in plastic for shipping. They are accordion-foldup cards, in the same style as the traditional IBM reference cards used on the major computers for years. Fold-up size is eight and one-half by three and three-quarter inches, so they will fit easily into the shirt pocket. These cards provide a complete summary of the manuals plus many extras at your fingertips.

RETAIL ORDER FORM

Please send me:	Card	Price			
( )	Copies of MODEL I BASIC & ASSEMBLER	\$4.95	( )	Copies of COLOR BASIC AND EXTENDED	4.95
( )	Copies of MODEL I BASIC-ONLY	2.95	( )	Copies of POCKET BASIC	2.95
( )	Copies of MODEL II BASIC & ASSEMBLER	5.95	( )	Copies of APPLE II & II PLUS BASIC	3.95
( )	Copies of MODEL II SVC	2.95	( )	Copies of APPLE II & II PLUS BASIC & 6502	4.95
( )	Copies of MODEL II COMMANDS & UTILITIES	3.95	( )	Copies of Z80	4.95
( )	Copies of MODEL III BASIC & ASSEMBLER	5.95	( )	Copies of ZX80/81 & TIMEX-SINCLAIR 1000	5.95
( )	Copies of MODEL III BASIC-ONLY	3.95			

NAME: \_\_\_\_\_  
 ADDRESS: \_\_\_\_\_  
 CITY \_\_\_\_\_ STATE \_\_\_\_\_ ZIP \_\_\_\_\_

Indiana Residents Add 5 Percent for Indiana Sales Tax

Wholesale prices available in quantities over 24.

Send Check or Money Order to:  
NANOS SYSTEMS CORP.  
BOX 24344  
SPEEDWAY, IN 46224  
(317) 244-4078





from  
**MICRO-80™ INC.**



# THE ULTIMATE WORD PROCESSOR

## MICRO-SCRIPT™

A professional word processor at an affordable price! Features enhancements found in programs three times its cost.

Speed typists will appreciate its tracking capability. Novices will enjoy quick familiarity. Regardless of your application, the versatility of MICRO-SCRIPT™ makes it the logical choice for saving time and money for both home and office environments.

Bells and whistles? You bet! MICRO-SCRIPT™ is line-oriented, offers expanded cursor control, user-defined printer and video options; provides character, word and line insertion, correction, mobility, replace and deletion; global search and replace; headers and footers, auto pagination, true justification line and title centering, name and address merging for multiple letters; prints up to four selectable character sizes on command and much more!

MICRO-SCRIPT™ has unlimited applications. It's a serious masterpiece which fills the void in any program library. It is compatible with all major printers on the market today.

Specify  
 Tape or Disk  
 Version

**TOLL-FREE**

(orders only)

**1-800-528-6050**

extension 3005

In Arizona

**1-800-352-0458**

extension 3005



Co-Co  
 Limited  
 Offer  
 \$26.95



**MICRO-80™ INC.**

2665 Busby Rural Road  
 Oak Harbor, WA 98277

— **Distributors Wanted** —

pin 2 on the MC6847. Be careful not to solder the pin to the socket. You won't be able to get the IC out if you do. Check the wiring and make sure that there are no shorts. Your wiring should look like the wiring in Figure 2. Now turn the power on. You should see the normal SIGN ON and copyright notice. Adjust the contrast, brightness and color

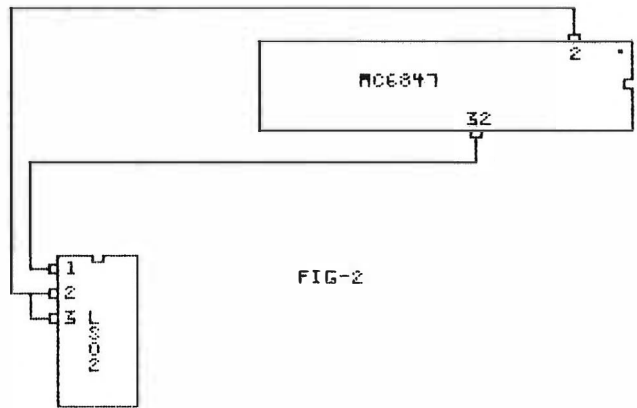

on your TV so that you get crisp green letters with no background shading.

The closing up of the unit is the same as the opening, but in reverse. Turn the power off and replace the RF shield.

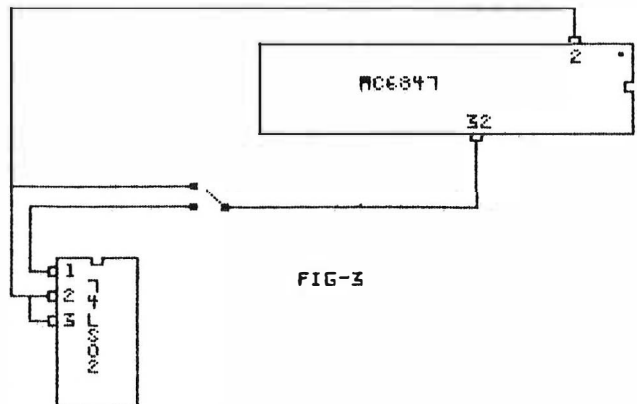

Again, make sure that there are no wires hanging out, and that there are no small pieces of wire or solder left in the closed area. Replace the keyboard and connector and put the lid back on. One thing to note when you are putting the bottom screws on is that there are two short screws. They go under the keyboard. If you put the long ones there you'll pierce a hole in the top cover. Do not overtighten them. After the computer is all back together again check all the functions just to make sure that all is running properly.

The whole operation should go off without a hitch, but if you do have problems retrace all of the above steps. The circuit does work, and if yours doesn't work you may have made a mistake somewhere. Some of you might want to add a switch to be able to change back and forth between normal and reversed screen. To do so, follow the wiring diagram in Figure 3. Make the wires long enough to be able to mount the switch on the outside cover or somewhere accessible when the cover is on. Warning! Wires that run outside of the RF shield can cause interference with your TV. Using a shielded wire will help. Ground the switch cover with a separate wire. This should take care of most of the RF problems.

Good luck.



# TAKE A CLOSER LOOK THERE'S SOMETHING For EVERYONE

## SOFTWARE

### CCM#3

by Charles Santee, Ed.D.

This program allows total communication for special persons and does this with only one joystick. Easy to use, and also recommended for young children; can help teach spelling and sentence structure. Excellent documentation.

32K EXT. . . . . **\$32.95**

### BIGNUM



If you dislike seeing numbers like 1.23045 E 23, and wish you could have **all** the accurate digits instead, then BIGNUM is for you. Add, subtract, multiply, divide and raise BIG numbers to BIG powers and get totally accurate results. Even if you are satisfied with an approximation, without this program the Color Computer would return an "OV ERROR" with this problem: 34↑45. BIGNUM returns the entire 68 digit result! Accurate to 1,024 digits in 16K & about 3,068 digits with 32 RAM.

16K. . . . . **\$9.95**

### SKY-DEFENSE



Can you survive the first wave of attack? Or the next? Or the next? Only your joystick will ever know! Features horizontal flight in highres graphics, and fast-paced action. Machine language; joystick required. 16K. . . . . **\$18.95**

### THE WALL



Here is a 9 color joystick game that isn't another "Breakout" but a new idea. You are a brick shooting Bricks at the WALL to get the brick on the other side! (strange plot) This one's unique. Time limit on play. Joystick required.

16K. . . . . **\$6.95**

## HARDWARE

### AUX-KEY

by JARB

(Auxiliary External Keyboard Unit)

This full size, industrial grade keyboard unit is P.C. board mounted for trouble free operation and years of use. Mounted in an attractive aluminum case with a 19-key numeric pad, AUX-KEY comes with long cable for remote placement of your 80C. No soldering required for installation. Will not affect normal operation of the original keyboard. . . . . **\$134.95**

### 16K-32K UPGRADE KIT

Kit includes 8 200 ns #4116 Factory Prime Chips, piggybacked sockets, SAM socket, and "32K" button to replace the 16K on your computer's case. Easy to remove. No soldering to computer. . . . . **\$25.95**

### 64K RAM CHIPS

200 ns #4164 chip set will upgrade your "E" board easily. Factory Prime Chips. (Compare the price elsewhere!). **\$69.95**

### Nanos Reference Cards

- Model I BASIC & ASSEMBLER. . . . . \$4.96
- Model I BASIC ONLY . . . . . 2.95
- Model II BASIC & ASSEMBLER . . . . . 5.95
- Model II SVC . . . . . 2.95
- Model II Commands & Utilities. . . . . 3.95
- Model III BASIC & ASSEMBLER . . . . . 5.95
- Model III BASIC ONLY . . . . . 3.95
- Color Computer & TDP-100
- Color BASIC & EXTENDED . . . . . 4.95
- POCKET BASIC . . . . . 2.95
- APPLE II & II+ BASIC . . . . . 3.95
- APPLE II & II+ BASIC & 6502 . . . . . 4.95
- Z-80 . . . . . 4.95

Add \$1.50 per software order and \$2.00 per hardware order for postage and handling.

California residents add 6% Sales Tax.

## QUASAR ANIMATIONS

1520 Pacific Beach Drive, San Diego, California 92109  
(619) 274-2202

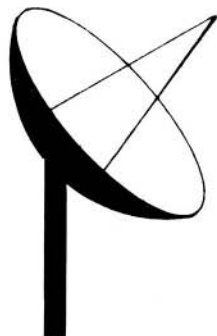

## Rapid Logger Handles Contest 'Heat'

By B. B. Witham, Jr.

W4CNZ

The program listed here is sort of a natural follow up to my *Logsheet* (December '82 *Rainbow*) and *Duper* (January '83 *Rainbow*). It is the fourth in my series of *Hamplication* programs and contains many features of the previous programs, plus some new ones. There seemed to be a need for a specialized contest log that could go beyond a plain log and a separate *Duper* program in providing rapid logging input during the heat of a contest. Most contests have a set of rules that specify purpose, hours of operation, point scoring and the like. Getting all the various rules and scoring details into one program was my aim. The problem is that the differing requirements made it impossible to match all the contest rules. However, most of the factors can be included and the printout can be user modified, if needed. Even the scoring scheme can be changed to fit a particular contest. At least this program will provide a basis for ham operators to use their imagination in modifications.

Prior to running the program, I execute an M/I clock routine to use as a time input to the log. Any clock routine can be used as long as it places the current time in the upper right corner, where the screen addresses are *PEEKed* and relocated into the correct place of the log format. I did not include it as part of the program, because the ones I have are adequately available (*Chromasette* "CoCo-Coocoo", August '82) and (*CCNews* "Time Clock," December '82), and they are copyrighted. Choose your own. Anyway, the time of contact and then the outgoing contact number are automatically entered into the log format and memory.

After the timer is started, the parameters of the contest are entered into memory to use in scoring and printout. A "0" is entered for "not applicable" or "no score" items.

During entry of the scoring scheme, some contest rules specify only adding the total number of scoring points, while others multiply the number of contacts by the scoring points. For instance: *prefixes*—if the score is just 1 point for each prefix worked, then enter "prefix pts:-1 and a '1' under (+) and 'enter' under (X). On the other hand, if the rules state to multiply the QSO's by two for each different prefix, then enter "prefix pts":-2, under (+) 'enter' and under (X) -1'. The scoring computations in lines 180-230 are adjusted accordingly.

The log format guides the operator through each QSO, keeping a record of those items needed for score and record. In the log form an "NA" is entered if the item is not a requirement of the particular contest. Upon entry of the call sign and frequency, the dupe routine checks to see if the station has been worked on that frequency before. If not, the program returns to the logging format for continued entry of data. If it is a dupe, this is reported and the program returns to input another call. On completion of each contact the record is dumped to disk. This is somewhat a waste of disk space, but it is quick, and avoids the problem of a full

buffer and loss of data with variable length records. Since the program is written for two disk drives, I use drive #1 for my data storage. If a single drive is used, then change lines 80 and 98 by dropping the ':1' after the extension. If a cassette system is used, then make the following changes

Line 80 change #1 to #-1, delete /LOG:1  
 Lines 82, 84, and 86 change #1 to #-1  
 Line 98 change #1 to #-1, delete /LOG:1  
 Lines 98, 100, 102, 104, 106, and 108 change #1 to #-1

After the contest completion, the whole file can be reloaded and reviewed and/or printed out. The scoring factors and score are computed and are part of the print out. Of course, change the call sign in line 144. Also, if your computer will not take the speed-up *POKE*, delete these from lines 66, 70, 72, 174, and 214.

If any of you have lazy or tired fingers, these programs are available on tape cassettes. You may send a self-addressed, stamped envelope to B.B. Witham, Jr., 3501 Sea Gull Road, Virginia Beach, VA 23452. Also this, as well as most other programs published in *the Rainbow* are available on *Rainbow on Tape*.

**Editor's Note:** The March issue of *A5 Amateur Television Magazine* is a special computer issue, with much emphasis on CoCo. For a free sample of *A5 ATV*, write Mike Stone, Editor, BDOQCD, P.O. Box H, Lowden, IA 52255-0408. See *A5 ATV's* ad for subscription information.

24	0356
50	0890
78	0CB8
114	0F7F
150	1433
180	17DD
END	1B02

The listing:

```

1 REM*****
2 REM UNIVERSAL CONTEST LOGGER
3 REM BY: BURT WITHAM JR. W4CNZ
4 REM 3501 SEA GULL ROAD
5 REM VIRGINIA BEACH, VA. 23452
6 REM (804)-340-2628
7 REM ALL RIGHTS RESERVED
8 REM VERSION 1.0 1/26/83
9 REM*****
10 CLEAR2000:GOTO234
12 Y=233:CLS2:FORX=1024 TO1055:P
OKEX,Y:POKEX+480,Y:NEXT:FORX=102
4 TO1535STEP32:POKEX,Y:POKEX-1,Y
:NEXT:PRINT@163," UNIVERSAL CONT
EST LOGGER ";:FORTM=1 TOTD:NEXT
14 DIMD$(3),EN$(12,200),ET$(5):J
    
```

```

=0:N=1:U=136:V=137:CT=0:SA=0:PF=
0:ZO=0:MB=0:TD=999:GOTO18
16 A$=INKEY$:IFA$="" THEN16 ELSE
RETURN
18 Q=484:Q$="PRESS ANY KEY TO CO
NTINUE":B=449:B$=" PRESS '# ' TO
RETURN TO MENU"
20 REM MAIN MENU
22 CLS:PRINT@12,"M E N U ":PRINT
@65,"1) ENTER CONTEST DATA":PRIN
T" 2) LOG QSO DATA":PRINT" 3) LO
AD LOG":PRINT" 4) PRINT LOG":PRI
NT" 5) REVIEW LOG":PRINT" 6) EXI
T PROGRAM":PRINT:PRINT" SELECT (
1 - 6)":INPUTM
24 IFM<1 OR M>7 THENSOUND1,5:GOT
022 ELSE ON M GOTO28,46,96,118,1
64,178
26 REM CONTEST DATA
28 CLS:PRINT@33,;:LINEINPUT"CONT
EST NAME AND OBJECT:":CN$
30 PRINT@193,"CATEGORIES: 1) CW
2) PHONE":PRINT" 3) SINGLE
OPER.":PRINT" 4) MULTIPLE OPER.
":PRINT" 5) EMERG. PWR.":PRINT"
6) LOW PWR.":PRINT" 7) FIELD
DAY SITE"
32 PRINT@448,;:INPUT"IF ITEM NOT
APPLICABLE ENTER '# ' OTHERW
ISE ENTER '# ' ". ";CAT(1),C

```

```

AT(2),CAT(3),CAT(4),CAT(5),CAT(6
),CAT(7)
34 CLS:PRINT@33,"MULTIPLIER POIN
TS:":PRINT@97,"(ENTER 0 IF NOT U
SED- NR.OF PTS IF USED -ENTER 1
UNDER EITHER ADD OR MULT.)":PR
INT@206,"(USED) (+) (X)":PRINT
@224,;:INPUT"QSO PTS: "":QP:
PRINT@245,"-----"
36 INPUT"DX PTS: "":DX:PRIN
T@277,;:INPUTDA:PRINT@282,;:INPU
TDM:INPUT"ZONE PTS: "":ZP:PRI
NT@309,;:INPUTZA:PRINT@314,;:INP
UTZM:INPUT"MODE PTS: "":MO:PR
INT@341,;:INPUTMA:PRINT@346,;:IN
PUTMM:INPUT"NR.OP. PTS: "":OP:P
RINT@373,;:INPUTOA:PRINT@378
38 INPUT"PREFIX PTS: "":CP:PRIN
T@405,;:INPUTCA:PRINT@410,;:INPU
TCM:INPUT"STATE PTS: "":SP:PRI
NT@437,;:INPUTSA:PRINT@442,;:INP
UTSM:INPUT"MEMBER PTS: "":MP:PR
INT@469,;:INPUTMA:PRINT@474,;:IN
PUTMM:CLS
40 PRINT@33,"FORMAT FOR CONTEST
NUMBERS: 'XXXXXX'":;:NN=NN+000001.
:FORTM=1 TOTD:NEXT
42 CLS:PRINT@129,;:LINEINPUT"ENT
ER CORRECT DATE TO START. USE
FORMAT: XX/XX/XX "":D

```

# ENTER THE FASCINATING WORLD OF GAME WRITER™

## A SIMPLE TO USE PROGRAM FOR YOUR COLOR COMPUTER

- For writing super-action video games with motion and sound
- For creating high resolution animated graphics scenes
- For experimenting with color, shapes, motion and sound
- For amateur or professional cartooning or commercial game authoring
- For the absolute beginner and for the expert programmer



GAME WRITER is a programming language with all the features you need to write great VIDEO GAMES. It includes a built-in screen oriented text editor, high resolution color graphics support, any number of player-shapes (SPRITES), a shape pattern editor, full TURTLE GRAPHICS, sound effects, support for joy sticks and much, much more. Each player-shape can be given a program to run which tells it what to do. All the player programs run simultaneously to create fantastic game effects. GAME WRITER IS GUARANTEED EASY TO USE. Even if you have never written a program of any kind you will amaze your family, your friends and yourself with the fantastic things you can do with it. The package includes a GAME WRITER rom pak, a complete easy to read manual and a set of sample programs ready to run. GAME WRITER is a great programming language for a child or an adult. GAME WRITER requires a minimum of 16K. Extended BASIC is not required.

### PRICE \$129

Orders must be prepaid via check, money order or major bank card. Phone orders accepted for bank cards only—COD orders not accepted. Quantity discounts available. Orders outside U.S. add \$5 shipping. WA state residents add 6.3% sales tax. Add 2 weeks for delivery if paid by personal check.

### WASHINGTON COMPUTER SERVICES

3028 SILVERN LANE  
BELLINGHAM, WA 98226  
1 (206) 734-8248





**\*\*PEEK AND POKES\*\***

Two of the most fascinating commands in the Basic language are PEEK and POKE. While we can't claim to be experts on the subject, we can offer a few ways to use PEEK and POKE to help you get more out of your CoCo.

The most famous POKE is probably the high-speed, or vitamin-E poke. There are actually two of these-- the well known POKE 65495,0, and the less common POKE 65497,0, which is actually faster. You lose control of the screen, but it can be used for searches, sorts, or calculations where screen control is not necessary.

It should be noted that these speedup techniques do not work on all computers. The following program will let you know if the pokes work on your computer, and will give you an idea of the speed difference of each.

```
10POKE65494,0:CLS:?"THIS PROGRAM
SHOWS HOW LONG IT TAKES THE
COLOR COMPUTER TO COUNT TO 1000
IN THREE DIFFERENT SPEED MODES:"
20GOSUB100:T1=T
30POKE65495,0:GOSUB100:T2=T:POKE
65494,0
40POKE65497,0:GOSUB100:T3=T:POKE
65496,0:POKE65494,0
50?:?"NORMAL SPEED TOOK";T1;
"SECONDS":?"POKE 65495 TOOK";T2;
"SECONDS":?"POKE 65497 TOOK";T3;
"SECONDS":END
100TIMER=0:FORX=1TO1000:NEXTX:T=
TIMER/60:RETURN
```

We went to this type of ad this month because we thought that you, like us, get tired of seeing endless lists of software. And, frankly, we're too small to compete with the folks taking out full-page ads and offering glossy catalogs. But we can offer you one thing--total dedication to the Color Computer and CoCo owner.

And we do have a fine list of CoCo products to choose from, including DONKEY KING, TELEWRITER, PLATINUM WORKSAVER, and the only under \$200.00 HARDWARE speech synthesizer available anywhere. We also stock most back-issues of RAINBOW.

So order from our Feb. ad or send \$.50 for our full catalog (refundable with order). And look for our ad next month for some more PEEKS and POKES.



**PCLEAR 80 SOFTWARE.**



**494 Cline Avenue  
Mansfield, OH 44907  
(419) 756-4873**

Note: We also carry the RAINBOW



Add \$2 shipping on orders less than \$50 Please add \$2 for COD. Ohio residents add 5% state sales tax

```
#:PRINT@Q,Q#;:GOSUB16:GOTO22
44 REM QSO DATA
46 CLS:PRINT@66,"HAVE YOU STARTE
D A M/L TIME ROUTINE?":FORTM=1
TOTD:NEXT:PRINT@129,"WHEN ENTER
ING LOG DATA, IF AN ITEM DOES N
OT PERTAIN TO THIS CONTEST ENT
ER 'NA'.":PRINT@B,B#:PRINT@Q,Q#;
:GOSUB16:IFA#="#" THEN22
48 FORI=1 TO300
50 CLS:PRINT@1,"LOG-":PRINT@8,"D
ATE: ";D#:PRINT@64,"call:-----"
:PRINT@76,"FREQ:----":PRINT@85,"
TIME:-----"
52 POKEU,4:POKEV,69:LINEINPUTEN$
(1,I):IFEN$(1,I)="AA" THEN62 ELS
EPRINT@76,"freq:----":PRINT@85,"
TIME:-----":POKEV,81:LINEINPUTEN
$(2,I):GOSUB70:PRINT@85,"time:--
----"
54 FORR=1051 TO1055:SS=PEEK(R):P
RINT@90+J,CHR$(SS);:ET$(J)=CHR$(
SS):J=J+1:NEXTR:EN$(3,I)=ET$(0)+
ET$(1)+ET$(2)+ET$(3)+ET$(4):J=0
56 :PRINT@96,"nmbr (out):";:PRIN
TUSING"#####";NN:PRINT@114,"(i
n):-----":POKEV,119:LINEINPUTE
N$(4,I):PRINT@128,"my rst:-----
":PRINT@147,"RST:-----":POKEV,1
35:LINEINPUTEN$(5,I):PRINT@147,"
rst:-----":POKEV,151
58 LINEINPUTEN$(6,I):PRINT@160,"
country:-----"
:POKEV,168:LINEINPUTEN$(7,I):PRI
NT@192,"state:-----"
-----":POKEV,198:LINEINPUTEN$(
8,I):PRINT@224,"prefix:-----":PR
INT@242,"ZONE:---":POKEU,4:POKEV
,231:LINEINPUTEN$(9,I)
60 PRINT@242,"zone:---":POKEU,4:
POKEV,247:LINEINPUTEN$(10,I):PRI
NT@256,"mbr nmbr:-----":PRINT@
273,"NOTES:->":PRINT@351,"<":POK
EU,5:POKEV,9:LINEINPUTEN$(11,I):
PRINT@273,"notes:->":PRINT@351,"
<":POKEV,23:LINEINPUTEN$(12,I)
62 PRINT@417,"CALL'AA' ENDS ENTR
Y MODE":GOSUB82:PRINT@B,B#:PRINT
@Q,Q#;:GOSUB16
64 IFA#="#" THEN22
66 NN=NN+1:N=N+1:NEXTI
68 REM DUPE CHECK
70 IFI>1 THEN72 ELSEIFI=1 THEN74
ELSERETURN
72 POKE65495,0:FORDU=1 TOI-1
74 IFEN$(1,DU)=EN$(1,I) AND EN$(
2,DU)=EN$(2,I) THEN76 ELSEIFI=1
THENRETURN ELSENEXTDU
76 POKE65494,0:DU=0:RETURN
78 POKE65494,0:SOUND50,5:PRINT@6
```

# Quality Software Is The Number One Priority At K & K Computerware



**LASER TANK** - Pit yourself in a game of strategy and excitement against the computer. You must defend your flag from attacking tanks and destroy them before they destroy your flag or you!!! High resolution graphics and four levels of difficulty. Only \$14<sup>95</sup>

**GAZON** - A machine language game that is surpassed by none on the market. The deadly Gazonians are trying to steal your supplies and you must stop them by shooting or ramming them. Action increases as fleets of Gazonians are destroyed. Only \$15<sup>95</sup>

**SHOOT TO SPELL AND FLASH MATH** - An educational package that helps kids learn to spell and educate them on elementary math. An absolute must for adults with school aged children. Joysticks required. Only \$12<sup>95</sup>

**SPACE HARVEST** - Pilot your spacecraft above the Planetoid Voltar stealing spacefruit and trying to avoid alien guards and the ground. Fast action machine language programs with high resolution graphics. Only \$14<sup>95</sup>

**HORSE RACE** - Can you pick the next Secretariat among our thoroughbreds? High speed, life like action for people of all ages. High resolution graphics. Only \$12<sup>95</sup>

**SERIAL TO PARELLEL CONVERTER** - Have a printer with a parellel port? Tired of waiting for a line list? With this little hardware device you can make your color computer run at any baud rate between 300 and 9600. Let K & K help your printer to go much faster!!! Only \$69<sup>95</sup>



**BLACKJACK** - A casino game that puts two players against the beady-eyed dealer of the house. This dealer deals the cards as good or even better than Intellivision. If you have any gambling blood at all this game is a must! Same rules as any Las Vegas casino. High resolution graphics. Only \$12<sup>95</sup>

**ALL GAME PROGRAMS** - require 16K extended (prices are set for cassette, add \$4<sup>00</sup> for disk, except business)

**PROGRAMMERS!!!** - K & K pays the highest royalties for your programs. If your program is good, send it to K & K and receive the best possible coverage!

**TRS-80 COLOR COMPUTER USERS** - New programs are added each week. Send \$100 for our complete catalog.



**K & K COMPUTERWARE**  
37326 Gregory Drive • Sterling Heights, Michigan 48077  
Telephone: (313) 264-7345



**POLARIS** - You are under the ocean in a submarine, attacking planes and enemy destroyers dropping depth charges attempting to destroy your sub. Can you destroy them before they destroy you? This is an extremely fast action machine language program with high resolution graphics. Only \$14<sup>95</sup>



**SUPER ZAP** - Enemy spaceships are attacking from all sides and your mission, should you choose to accept it is to defend your starbase from the deadly Armada of Pyrus. This will be a dangerous mission since the Pyrus Armada has never been defeated by any humanoid. Action increases as the game progresses. Only \$14<sup>95</sup>

**HOME HELPERS** - Have problems balancing your checkbook, remembering important dates or phone numbers, and your mailing lists. Let K & K and your color computer help you. Only \$14<sup>95</sup>

**BOWLING SCORED FOR DOLLARS** - Do your leagues bowling averages. This program will keep individual scores, team totals, individual averages, team standings, and print all this information to your line printer. Minimum 16K disk required (on cassette too!). Only \$14<sup>95</sup>

**INVENTORY CONTROL** - This program contains all the necessary features required for all types of inventories, such as sorting of inventory by stock number. This program will list stock number, description, amount in stock, cost, wholesale, profits. Minimum 16K disk required. Only \$39<sup>95</sup>

**PROPERTY INVENTORY** - This program lists inventory by department, date purchased, and property numbers. Minimum 16K disk required. Only \$29<sup>95</sup>

**ACCOUNTS PAYABLE AND RECEIVABLE** - These two programs will control the incoming and outgoing money flows for all your business accounts. Only \$59<sup>95</sup>

```

9, "dupe!!": FORTM=1 TO500: NEXT: DU
=0: GOTO46
80 REM SAVE LOG
82 VERIFY ON
84 FS$="L"+STR$(NN)
86 OPEN"O", #1, FS$+"/LOG:1"
88 IFI=1 THENWRITE#1, CN$: FORP=1
TO7: WRITE#1, CAT(P): NEXTP: WRITE#1
,QP, DX, ZP, MO, OP, PP, CP, SP, MP, D$
90 FORZ=1 TO3: WRITE#1, EN$(Z, I): I
FEN$(1, I)="AA" THENCLOSE#1: GOTO2
2 ELSENEXTZ: WRITE#1, NN: FORZ=4 TO
12: WRITE#1, EN$(Z, I): NEXTZ
92 CLOSE#1: RETURN
94 REM LOAD LOG
96 CLS: PRINT@103, "DISK DRIVE REA
DY?": PRINT@226, "PRESS <ENTER> TO
LOAD LOGS": PRINT@B, B$: GOSUB16
98 IFA$<>CHR$(13) THEN22
100 NR=1: I=1
102 FS$="L"+STR$(NR)
104 PRINT@356, "LOADING LOG: -"; FS
$+"/LOG": OPEN"I", #1, FS$+"/LOG:1"
106 IFEOF(1)=-1 THEN114
108 IFI=1 THENINPUT#1, CN$: FORP=1
TO7: INPUT#1, CAT(P): NEXTP: INPUT#
1, QP, DX, ZP, MO, OP, PP, CP, SP, MP, D$
110 FORZ=1 TO3: INPUT#1, EN$(Z, I):
IFEN$(1, I)="AA" THEN114 ELSENEXT
Z: INPUT#1, NN: FORZ=4 TO12: INPUT#1
, EN$(Z, I): NEXTZ
112 CLOSE#1: I=I+1: NR=NR+1: GOTO10
2
114 CLOSE#1: CLS: SOUND180, 1: PRIN
T@230, "DISK LOAD COMPLETE.": FORT
M=1 TOTD: NEXTTM: GOTO22
116 REM PRINT LOG
118 CLS: PRINT@105, "PRINTER READY
?": PRINT@B, B$: PRINT@Q, Q$: GOSUB
16: IFA$="#" OR A$<>CHR$(13) THEN
22
120 CLS: LN=0: PRINT@171, "PRINTING
": PRINT#-2: PRINT#-2, CHR$(31) "CON
TEST: -"; CHR$(30)
122 X=1: Y=LEN(CN$): LN=LN+2: PRINT
#-2, MID$(CN$, X, 1);
124 PRINT#-2, MID$(CN$, X, 1);
126 IF POS(-2) >70 THENIFMID$(CN$
, X, 1)=CHR$(32) THENPRINT#-2, CHR$
(13): LN=LN+1
128 IFX=Y THEN130 ELSEX=X+1: GOTO
124
130 PRINT#-2, CHR$(13): LN=LN+1
132 PRINT#-2, "STATION INFO: 1) C
W-"; IF CAT(1)=0 THENPRINT#-2, "N
O"; ELSEPRINT#-2, "YES";
134 PRINT#-2, " 2) PHONE-"; IF
CAT(2)=0 THENPRINT#-2, "NO"; ELSE
PRINT#-2, "YES";
136 PRINT#-2, " 3) SINGLE OPE

```

```

RATOR-"; IFCAT(3)=0 THENPRINT#-2
, "NO"; ELSEPRINT#-2, "YES": PRINT#
-2, " 4) MULTIPLE OPERATOR-"; IF
CAT(4)=0 THENPRINT#-2, "NO"; ELSE
PRINT#-2, "YES";
138 PRINT#-2, TAB(15) " 5) EMER
GENCY POWER-"; IFCAT(5)=0 THENPR
INT#-2, "NO"; ELSEPRINT#-2, "YES";
140 PRINT#-2, " 6) LOW POWER (
QRP)-"; IFCAT(6)=0 THENPRINT#-2,
"NO" ELSEPRINT#-2, "YES"
142 PRINT#-2, " 7) FIELD DAY SIT
E-"; IFCAT(7)=0 THENPRINT#-2, "NO
" ELSEPRINT#-2, "YES"
144 PRINT#-2: PRINT#-2, "TOTAL CON
TACTS: "; I-1: LN=LN+5: GOSUB182
146 PRINT#-2, "COUNTRIES WRKD: "; C
T; TAB(21) "STATES WRKD: "; ST-1; TAB
(37) "PREFIXES: "; PF-1; TAB(49) "ZON
ES: "; ZO-1; TAB(59) "MEMBERS WRKD: "
; MB-1: LN=LN+1
148 PRINT#-2: PRINT#-2, "TOTAL SCO
RE: "; TP: LN=LN+2
150 PRINT#-2: PRINT#-2, CHR$(31) "
LOG: -W4CNZ"; CHR$(30); TAB(50) "DAT
E: -"; D$: PRINT#-2: PRINT#-2, TAB(5)
"CALL"; TAB(15) "FREQ"; TAB(22) "TIM
E"; TAB(30) "OUT NR. "; TAB(40) "IN N
R. "; TAB(51) "MY RST"; TAB(59) "RST"
; TAB(66) "MEMBR NR. ": LN=LN+4
152 FORG=1 TOI: IFG=I THEN158
154 PRINT#-2: PRINT#-2, TAB(4) EN$(
1, G); TAB(15) EN$(2, G); TAB(22) EN$(
3, G); TAB(30); PRINT#-2, USING"###
###. "; G; PRINT#-2, TAB(41) EN$(4, G
); TAB(52) EN$(5, G); TAB(59) EN$(6, G
); TAB(67) EN$(11, G): LN=LN+2: IF LN
=>60 THEN156 ELSENEXTG: GOTO158
156 FORSK=1 TO6: PRINT#-2: NEXTSK:
LN=0: NEXTG
158 PRINT#-2: PRINT#-2: PRINT#-2, T
AB(40) "OPERATOR(s): -----
-----": LN=LN+3: SK=66-LN: FO
RLS=1 TOSK: PRINT#-2: NEXT
160 SOUND180, 3: SOUND150, 3: GOTO22
162 REM REVIEW LOG
164 CLS: NB=1: PRINT@1, "LOG-": PRIN
T@8, "DATE: "D$
166 FORK=1 TOI: PRINT@64, "CALL: ";
EN$(1, K): IFEN$(1, K)="AA" THEN174
ELSEPRINT@76, "FREQ: "; EN$(2, K): P
RINT@85, "TIME: "; EN$(3, K): PRINT@9
6, "NMBR (OUT): "; PRINTUSING"####
###"; NB: PRINT@114, "(IN): "; EN$(4, K
)
168 PRINT@128, "MY RST: "; EN$(5, K)
: PRINT@147, "RST: "; EN$(6, K): PRINT
@160, "COUNTRY: "; EN$(7, K): PRINT@1
92, "STATE: "; EN$(8, K): PRINT@224, "
PREFIX: "; EN$(9, K): PRINT@242, "ZON

```

# Four smart ways to make your Atari 400/800, TRS-80 COLOR, VIC-20 and Commodore 64 much more intelligent.

## 1

**The Color Accountant pays for itself.** This *complete* personal financial package is designed to make your money easier to manage. Included are:

1. Checkbook Maintenance
2. Chart of Accounts
3. Check Search
4. Income/Expense Statement
5. Net Worth Statement
6. Color Graph Design Package
7. Home Budget Analysis
8. Color Payments Calendar
9. Mailing List
10. Decision Maker

This unique menu-driven package requires less than one hour data input per month. The Color Accountant has over 60 pages of documentation including examples and step-by-step instructions. TRS-80 COLOR requires Ext. Basic and 16K for cassette, 32K for diskette; Atari 400/800 requires 24K for cassette, 32K for diskette; VIC-20 requires 16K Expander. Now available for Commodore 64.

**\$74.95 cassette;  
\$79.95 diskette**

## 2

**The Tax Handler makes April 15th just another day.**

This is the perfect complement to our Color Accountant. The Tax Handler will help prepare your tax returns and probably save you money. Included are:

1. Form 1040 (Long Form)—*filing status, exemptions, income, income adjustments, computation of tax, tax credits and payments or balance/refund due.*
2. Schedule A (Itemized Deductions)—*medical and dental deductions, taxes, interest expenses, contributions, casualty/theft losses, miscellaneous deductions and summary.*
3. Schedule G (Income Averaging)—*base period income and adjustments, computation of averageable income and computation of tax.*

Additional schedules or alterations to the tax codes will be available separately in our monthly magnetic magazines. Atari 400/800 requires 24K for cassette, 32K for diskette. VIC-20 requires 16K Expander. Now available for Commodore 64.

**\$34.95 cassette;  
\$39.95 diskette**

## 3

**You'll love your computer with The Magnetic Magazine.**

Our magnetic magazines will entertain, inform, educate, challenge and delight you. Each issue contains 4 to 7 ready-to-use quality programs, all fully listable. Every issue includes a newsletter containing instructions, tips on programming techniques and a line-by-line examination of the feature program. And starting with issue number 8, the first in a series of tutorials on machine language programming, Database I with a new application every following issue and a new utility in our Utility-of-The-Month section. And word processing is coming soon!

A full year's subscription consists of 10 issues—over 50 programs a year at a mere fraction of their cost. Available for TRS-80 COLOR Ext. Basic, Atari 400/800; all require 16K. Back issues available.

**One year subscription:  
\$50.00 cassette;  
\$75.00 diskette  
Half year subscription:  
\$30.00 cassette;  
\$45.00 diskette  
Sample issue:  
\$10.00 cassette;  
\$15.00 diskette  
VIK VIDEO issue 1 available  
for VIC-20; \$12.95 cassette**

## 4

**The Learning Center teaches and enlightens children.**

Our exceptional educational programs are classroom designed and tested. These unique packages have been invented to introduce 3 to 9 year olds to the ease of computer learning. Through the use of basic concepts such as colors, shapes, numbers and letters, children understand counting, math and language skills. Each program is designed to develop a specific skill, rewarding each correct answer with music and a happy face. Most are compatible with our new Edumate Light Pen \$34.95.

Available for Atari 400/800, VIC-20 and Commodore 64; all require 8K for cassette, 16K for diskette. Also available for Timex/Sinclair 1000 and TI-99.

**Please ask about programs available and their prices for Pre-School, Kindergarten and Grades 1 & 2. Prices range from \$8.95 for a single cassette to \$79.95 for a complete set on diskette.**

Order now! See your local dealer or order direct. New catalog \$2.00. Visa and MasterCard accepted—please add \$2.00 for postage and handling.  
Call toll free!

# 1-800-334-SOFT

DEALER INQUIRIES INVITED

# programmer's institute

a division of **FUTURE HOUSE** — dept. r  
p.o. box 3470, chapel hill, north carolina 27514, 919-967-0861



# compu•sette®

## TAPES & DISKS

100% ERROR-FREE  
FULLY GUARANTEED



Compu•sette, a product of MICRO-80 INC

### The Micro-Trac™ Generation

Used by Software Firms & Computer Hobbyists  
Choice of School Districts Nationwide

CASSETTES	MINI 12-PAK	STANDARD 24-PAK
C-05 .....	\$ .79	\$ .59
C-10 .....	\$ .89	\$ .69
C-20 .....	\$ .99	\$ .89
C-30 .....	\$1.29	\$1.09
Custom Cases .....	\$ .25	\$ .21

Cases recommended to protect sensitive cassettes.

5 1/4" DISKETTES	MINI 5-PAK	STANDARD 10-PAK*
Soft Sector Single Sided S/D Density .....	\$14.95	\$26.95

\*10 PAK w/custom library case, add \$3.00

— UPS SHIPPING —

(No. P.O. Boxes please)

\$3.00 per pack

— Canadian shipping multiply by 2 —

**No. 1 Magnetic Media in the USA!**

— Write for volume prices —

TOLL-FREE  
(orders only)

1-800-528-6050  
ext. 3005

In Arizona State  
1-800-352-0458  
ext. 3005

# MICRO-80™ INC.

E. 2665 Busby Road  
Oak Harbor, WA 98277  
1 (206) 675-6143



```

E: ";EN$(10,K)
170 PRINT@256,"MBR NMBR:";EN$(11
,K):PRINT@273,"NOTES:";EN$(12,K)
:PRINT@B,B$:PRINT@Q,Q$::GOSUB16:
NB=NB+1:NEXTK
172 IFA$="# " OR A$<>CHR$(13) THE
N22
174 CLS:PRINT@170,"END OF FILE":
FORTM=1T0999:NEXT:GOTO22
176 REM EXIT ROUTINE
178 CLS:PRINT@174,"END":FORTM=1T
OTD:NEXT:CLS:END
180 REM COMPUTATION ROUTINES
182 POKE65495,0:FORCU=1 TOI
184 IFCU>1 THENFORCD=1 TOCU-1:IF
EN$(7,CD)=EN$(7,CU) THEN188 ELSE
EXTCD
186 IFEN$(1,CU)="AA" OREN$(7,CU)
="NA" THEN190 ELSE CT=CT+1
188 NEXTCU
190 FORSU=1 TOI
192 IF SU>1 THENFORSD=1 TOSU-1:I
FEN$(8,SD)=EN$(8,SU) THEN196 EL
S ENEXTSD
194 IFEN$(8,SU)="NA" THEN196 EL
S EST=ST+1
196 NEXTSU
198 FORPU=1 TOI
200 IF PU>1 THENFORPD=1 TOPU-1:I
FEN$(9,PD)=EN$(9,PU) THEN204 EL
S ENEXTPD
202 IFEN$(9,PU)="NA" THEN204 EL
S EPF=PF+1
204 NEXTPU
206 FORZU=1 TOI
208 IF ZU>1 THENFORZD=1 TOZU-1:I
FEN$(10,ZD)=EN$(10,ZU) THEN212 E
L SENEXTZD
210 IFEN$(10,ZU)="NA" THEN214 EL
SEZO=ZO+1
212 NEXTZU
214 FORMU=1 TOI
216 IFEN$(11,MU)="NA" THEN218 EL
SEMB=MB+1
218 NEXTMU
220 IFDA=1 THENDX=(CT-1) ELSEIFD
M=1 THENDX=(DX*CT-1)
222 IFZA=1 THENZP=ZO-1 ELSEIF Z
M=1 THENZP=ZP*(ZO-1)
224 IFSA=1 THENSP=ST-1 ELSESP=SP
*(ST-1)
226 IFCA=1 THENCP=PF-1 ELSEIFSM=
1 THENCP=CP*(PF-1)
228 IFMA=1 THENMP=MB-1 ELSEIFMM=
1 THENMP=MP*(MB-1)
230 TP=QP+DX+SP+CP+ZP+MP+MO+OF+P
P:POKE65494,0:RETURN
232 REM PCLEARER
234 PCLEAR1:GOTO12
    
```



# JARB IN C SOFTWARE HARDWARE

COMPUTER PRODUCTS

## ADVENTURES

### MANSION OF DOOM

by PAL Creations

Rescue the Princess Marlena from the mysterious Count Von Steinoff and reunite her with the townspeople of her village in Transylvania. The Count's mansion has 76 distinct locations for you to explore in your rescue attempt.

32K EXT ..... \$14.95

### S.S. POSEIDON

by Bill & Debbie Cook

You are aboard the S.S. Poseidon when it is capsized by a tidal wave. It is floating bottom-up on the surface and taking on water. Will you survive to tell your tale?

16K EXT ..... \$14.95

### THE FINAL COUNTDOWN

by Bill & Debbie Cook

You are outside a missile base which has just been evacuated because a beserk General has started the countdown on a nuclear missile - target: MOSCOW. Your mission, if you accept it, is to stop the missile launch and prevent WWIII.

16K EXT ..... \$14.95

### STALAG & ENO

by PAL Creations

1) You are an allied POW in a German prison camp in 1944 and were forgotten in the hot box when the camp was evacuated due to unexpected bombing raids. How will you get out ALIVE?

2) Your eccentric old aunt just died and left you a fortune in cash. To prove you deserve it, you must decipher the clues and find your fortune, which she hid in her living room.

32K EXT ..... Both for \$14.95

### BIG NUM

by Quasar Animation

..... \$6.95

### THE WALL

by Quasar Animation

..... \$9.95

### MYSTERY MAZE

by Faith Robinson Enterprises

..... \$14.95

### DOODLE BUG

by Computerware

..... \$24.95

### COLORPEDE

by Intracolor

..... \$29.95

### THE WARRIOR & THE WIZARD

by Jimmy Jones

Choose your character, weapons and armor to battle warlords, pygmies and other foes as well as hidden monsters, snakes, booby traps and numerous other dangers in this disk based graphics assisted adventure. Beware of the EVIL WIZARD!

32K EXT ..... Plus one disk \$19.95

### CCM#3

by Charles Santee, Ed.D.

Using only one joystick, CCM#3 allows total communication for special persons. Contains many features and is easy to use. Excellent for young children. Also helps teach spelling and sentence structure. Complete documentation.

32K EXT ..... \$32.95



### SKY DEFENSE

By Quasar Animations

Fight off the attacking waves of enemy craft in fast realtime combat. Machine language.

16K ..... \$18.95

### BLACK SANCTUM

by Mark Data

..... \$19.95

### CALIXTO ISLAND

by Mark Data

..... \$19.95

### EL DIABLERO

by Computerware

..... \$19.95

# JARB IN C SOFTWARE HARDWARE

COMPUTER PRODUCTS

1636 D Avenue, Suite C  
National City, CA 92050  
(619) 474-6213

Dealer/Author Inquiries Invited

All programs warranted 60 days from date of purchase to original purchaser. Unless otherwise specified, shipping and handling \$2.00 per order. California Residents add 6% sales tax.



### JUNGLE TREK

Lost in a jungle with wild animals lurking; your only survival is to find a safe compound before you are lunch for lions; high resolution; multi-color.

16K EXT ..... \$14.95



### LAZER STAR & HELO BATTLE

1) 2 players avoid destruction by blasts of mysterious lazerstar while battling each other for possession of Lazerstar

16K EXT

2) 1 player/2 joystick combat game to blow up 5 blockhouses while watching fuel, ammo, and avoiding anti-aircraft fire

16K EXT ..... Both for \$14.95



### JARB CODE

Encode/decode important messages or other information in a virtually unbreakable format.

16K Standard/Extended ..... \$15.95



### BIORHYTHM/PSYCHIC APT.

1) Prints biorhythm charts of nearly unlimited length; attractively formatted for use on Line Printer VII.

16K

2) Your psychic ability is determined through questions evaluating your psychic experiences

16K Ext ..... Both for \$15.95

### SCORE-EZ

From 1 to 6 people can play this excellent adaptation of a popular board game. The computer keeps score for all players, and rolls dice. You can roll again just like the original game. Properly position the results of each turn for maximum score. The only thing you will need besides your computer is players. Color graphics and sound will entertain you for hours, and it's EZ to play.

16K EXT ..... \$15.95

U.S FUNDS ONLY  
C.O.D. ORDERS ACCEPTED  
NO CREDIT CARD ORDERS

# -COMPUTER SHACK-

## JOYSTICKS

The Radio Shack joysticks are ok but there are a lot of better ones on the market. Atari has the most joysticks on the market but even their joystick leaves a lot to be desired. Many companies have started making Premium joysticks. We feel that the WICO is the best of the Premium joysticks. The Wico stick will not plug in to the COCO though, you need an adapter. The adapter will work with any Atari type joystick. You could buy one Wico for yourself and use an old Atari stick for your friends (you'll never lose). Or splurge and get two Wicos.

**WICO**

# COMMAND CONTROL™

**The arcade joystick comes to the home.**

The arcade is where the video game craze began... where the most advanced electronic technology was developed.

Now, WICO brings the excitement and challenge of the arcade to your home.

WICO, the world's largest designer and manufacturer of controls for arcade games, brings 42 years of experience to Command Control. You get arcade accuracy... arcade control... arcade durability.

Command Control makes the game more fun... helps make you a better player.

NEW!



**EXCLUSIVE COMMAND CONTROL FEATURES:**

- Two fire buttons
- Extra long 5-foot cord
- 6-leaf switch design for 8-way directional action
- Comfortable bat handle grip
- Compact, rubber grip base
- Works perfectly with 9 home video games and computers
- Full one-year limited warranty

**WICO CONVERTER** · Atari Plug to COCO (CONVERTS TWO STICKS)

ONLY.....	<b>\$17.95</b>
WICO JOYSTICK.....	<b>\$29.95</b>
WICO FAMOUS RED BALL.....	<b>\$34.95</b>

**SPECIAL · BUY TWO STICKS AND A CONVERTER AND TAKE 10% OFF ALL THREE**

## New Low Price - Only \$399 For the Best Printer On The Market!

Now C. Itoh has done it again. They have taken the best selling printer under \$500 and lowered its price to only \$429.95. And as a special discount if you send us a certified check for \$399.95 we will rush you one of these gems within 24 hours. These are parallel printers and have a one year guarantee. If you ever need servicing there are over 500 service centers throughout the U.S. This printer has very good looking printing.

The COCO has a serial printer port and to use a printer you must either buy a serial printer (they cost more) or buy a converter. Computer Shack now has a converter that stores data in its memory until the printer is read for it freeing the computer so that you can use it. This is an outstanding feature as most printers are fairly slow.

Or if you want a regular converter with no internal memory we have them too.

C. ITOH PROWRITER.....	<b>\$429.95</b>
C. ITOH PROWRITER WITH CERT. CHECK.....	<b>\$399.95</b>
COMPULINK SERIAL TO PARELLEL CONVERTER.....	<b>\$259.95</b>
X-TRA 16K OF MEMORY FOR COMPULINK (64k MAX).....	<b>\$30.00</b>
SERIAL TO PARELLEL CONVERTER NO MEMORY.....	<b>\$69.95</b>

## MODEMS

At Computer Shack we sell two different modems. The Hayes Smart Modem at \$239.95 and the Anchor Signalman for only \$99.95.

The Hayes 300 baud is the one we use and recommend. It has all of the features any one could ask for. But if you can't afford this modem then we would like to recommend the Anchor Signalman a direct connect 300 baud modem.

# COMPUTER SHACK

1691 Eason ● Pontiac, Michigan 48054

Info: (313) 673-8700 ● Orders: CALL TOLL FREE (800) 392-8881

MasterCharge and VISA OK. Please add \$3.00 for shipping in the U.S.A. · \$5.00 for Canada or Mexico · Proper postage outside of U.S. · Canada · Mexico.

Dealers: We are distributors for all items in this ad. Write for our catalog and price list. CS 100

## PRINT #-2,

of Spectrum Projects and taking issue with a letter we printed in which the writer expressed dissatisfaction with the Spectrum Stick joystick.

Mr. Cassidy's letter reads in part:

"Over the past twelve months I have had several dealings with Spectrum Projects and purchased many products, including the Spectrum Stick. I agree with your reviewer that it is an excellent joystick. Indeed, I have been satisfied with everything I have purchased from Spectrum Projects.

"However, the satisfaction with a specific product is not the point at hand. I was particularly concerned with the inference that 'Spectrum gets away with taking people.' In my many contacts with Spectrum Projects, I have always found Mr. (Bob) Rosen and his staff extremely friendly, courteous and, more importantly, fair and honest.

"It concerns me that (the writer of the original letter) gets away with a slur on a completely reputable company...I find it completely irresponsible on your part to publish such a potentially damaging letter without having fully researched the matter."

We are glad that this issue came up and that we have an opportunity to explain how we at *the Rainbow* deal with letters of complaint and, finally, how they find their way into our letters column. I want to explain it here, primarily because I think it will help everyone to know about the procedures we are supposed to follow.

But, let me emphasize, we are not a consumer watch-dog agency. In that regard, we certainly will try to help you solve any problem you may have—with an advertiser or, for that matter, with a non-advertiser. The *only* place we draw the line is with other publications. And there is a simple reason for that. To ultimately carry a letter about another publication failing to honor a subscription, being consistently late or the like only sounds—at least to us—like *the Rainbow* trying to knock a competitor, no matter how "friendly" that competitor might be. So, generally speaking, you won't see much here about any other publication.

Aside from that, we have a procedure that we are supposed to follow in every case. Letters of complaint are forwarded to the firm in question, as a matter of information for the firm. We work on the assumption that you would like to have the problem resolved and, frankly, many times a letter to a third party is enough to resolve the issue. Firms are asked to let us know what has been done, or whether they would like to make a response if we print the letter in question.

I am beginning to get really excited about RAINBOWfest—which is, after all, “CoCo’s Very First

Usually, most of the problems our readers experience are resolved in this way: Oftentimes it is only a lack of understanding on the part of one party or another, sometimes a problem with either the Postal Service or another carrier such as UPS.

We have two concerns in issues such as this. The first is for our readers, in terms of assisting them in any way possible. Since *the Rainbow* has been founded, I suspect several hundred disputes have been easily resolved when the two parties talked it out, either by mail or telephone.

The second concern is for the firm in question. We are fully aware of the “power of the press” and we intentionally set up procedures so that the firm has an opportunity to respond. To do otherwise would allow anyone with a “bone to pick” against someone else to simply fire off a letter and do considerable damage to someone’s reputation.

In the case of the letter about which Mr. Cassidy wrote, this system did break down and the letter was printed before we offered Spectrum Projects an opportunity to respond. It was a serious error on our part and for that error, we wish to apologize to Mr. Bob Rosen and to Spectrum Projects. As a footnote, we understand the question has been fully resolved.

We do not wish to set ourselves up as an arbiter of disputes. That isn’t our job. At the same time, we want to help settle any disputes which may arise in any way we can. And, we will publish “Brickbats” when the situation warrants—hopefully, at least, with a response from the other side. In short, we want to protect you, the reader’s, right to complain. But, we also have the responsibility to protect firms from damaging comments which may not be their fault.

We feel, at least I do, that we have a responsibility to all concerned.

Finally, on a less weighty topic, I want to formally announce the beginning of *the Rainbow* Simulation Contest.

We expect the Simulation Contest, in terms of prizes, to be even bigger than the Adventure Contest for which the winners were announced in January. We are aiming for a special “Simulation Issue” this summer and we encourage your entries. To that end, we plan to publish a couple of Simulations to help you in the months ahead. But don’t wait for them! Get going. We expect to set a May 30 deadline for entries. And, the sooner you get working the better.

—Lonnie Falk

## RAINBOWfest

Chicago April 22-24

### GRAB BAG



GRAB BAG IS THE BIGGEST SOFTWARE BARGAIN AROUND. NOT A BUNCH OF SPACE-FILLERS BUT HANDY UTILITIES YOU CAN USE EVERY DAY. INCLUDES OUR EDITOR AND FILESYS, DISK RECOVERY, TAPE UTILITIES, AND MORE! MORE DETAILS IN OUR CATALOG ON TAPE NO 3. GRAB BAG IS \$49.95. GET BOTH GRAB BAG AND MASTER DISK FOR 69.95.

### MASTER DISK

TROUBLE FINDING YOUR DISK PROGRAMS? MASTER DISK TO THE RESCUE! ONCE YOU TRY IT YOU’LL WONDER HOW YOU EVER GOT ALONG WITHOUT IT. NO TYPING REQUIRED! MASTER DISK CREATES FILES DIRECTLY FROM YOUR DISK DIRECTORIES AND SEARCHES THEM IN 5 MODES. READ ANY DIRECTORY WITHOUT SWITCHING DISKS. SEARCH ALL YOUR DISKS FOR A DESIRED FILENAME. FIND DISKS WITH FREE SPACE. INCLUDES ACCESSORY PROGRAMS TO PRINT AN ALPHABETIC LIST OF ALL OF YOUR FILES (32K FOR SORT REQUIRED) OR REBUILD A CRASHED DIRECTORY. NEW UPGRADED VERSION STILL RUNS IN 16K SYSTEMS. \$49.95

### DUNGEON MAZE

TIRED OF READING YOUR WAY THROUGH ADVENTURE GAMES? TAKE A STROLL THROUGH THE DUNGEON MAZE! SEE THE ROOMS, PASSAGES, AND OBJECTS AS YOU PASS THROUGH. SEARCH FOR MAGIC ITEMS YOU NEED TO ESCAPE. FREE THE KIDNAPPED PRINCESS HELD CAPTIVE BY THE EVIL TROLL. BEWARE OF MAGIC TRICKS AND TRAPS! 32K EXTENDED BASIC REQUIRED. \$24.95

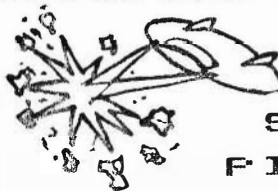

### STAR PILOT

TAKE A TREK INTO OUTER SPACE TO DEFEAT THE ENEMY FROM BEYOND THE GALAXY. THIS IS NOT JUST ANOTHER PUSH THE BUTTON AND SHOOT GAME. TO FIND AND DESTROY THE ENEMY YOU WILL NEED A STEADY HAND AT THE HELM, CLOSE ATTENTION TO YOUR CONTROL PANEL, AND A LITTLE LUCK. CALL YOUR CREW FOR REPAIRS, TRY A RUSE, OR GO IN FIRING TO SAVE OUR GALAXY. “SHIP’S COMPUTER” TELLS YOU SHIP’S STATUS OF A MAP OF THE KNOWN GALAXY. REQUIRES 16K EXTENDED BASIC AND INCLUDES 16K NOVICE VERSION AND 32K VERSION WITH MORE CHALLENGE. \$19.95

THIS IS A PACKAGE OF FOUR SIMPLE GAMES FOR CHILDREN. SOME NON-EXTENDED AND SOME EXTENDED BASIC. \$19.95

### REDUCED PRICES

EDITOR .....\$14.95  
FILESYS .....\$9.95

### CATALOG

OUR LATEST “CATALOG ON TAPE (NO 3) REVISED FOR LATEST PRICES AND PROGRAMS IS \$3. FLIP SIDE HAS 2 NOVELTY PROGRAMS AND A TAPE UTILITY SIMILAR TO THOSE SEEN ADVERTISED FOR TWICE THIS PRICE. (SUCH A DEAL!)

MASTER DISK & GRAB BAG AVAILABLE ON DISK ONLY. CATALOG ON TAPE ONLY. ALL OTHERS, TAKE YOUR CHOICE. SAME PRICE! NO SHIPPING CHARGE. INDIANA RESIDENTS INCLUDE SALES TAX.

Circle City Software

P.O. Box 30166

Indianapolis, Indiana  
46220

COMPUSERVE EMAIL NO. C71645,51





## Stress Evaluator: Coping Techniques Called Helpful

Tension. Pain. Pound. Thump. Sounds like an old familiar commercial for a popular headache remedy. While an analgesic may indeed cover up pain, it does nothing to ameliorate the *cause* of the pain. Taking a pain medication is rather like cutting the wires to a fire alarm—it gets a lot quieter for a while, but watch out, the fire is still burning!

Today, the scientific community recognizes the powerful role that stress can play in bodily discomforts and illnesses. Headache, high blood pressure, lowered resistance to infections, nervous breakdowns, stroke and even cancer are some examples of conditions that may be caused or aggravated by excessive stress. Like any delicate piece of machinery, when the body is over stressed, bits and pieces begin to break down. Inevitably, there are innumerable prescription and non-prescription nostrums whose primary effect is to suppress the symptoms of an over stressed body and mind. It is all too easy to pop a pill or plop a couple of dissolving tablets into a glass of water; in fact, the drug industry heartily encourages you to do this with its high budget advertising. The message seems to be: It doesn't matter if you abuse your body, somewhere there is a pill, tablet or capsule that will take care of your symptoms.

If a philosophy of pill popping does not agree with you, there is an alternative: learn ways to evaluate your stress level and learn techniques for successfully coping with stress.

Petrocci Freelance Associates has recently released *Stress Evaluator*, a cassette based program for the Color Computer. The program incorporates questionnaires for evaluating your stress level, evaluating your ability to cope and assessing your comfort level. Also included are instructions for reducing stress through a meditative technique and a graphics screen to aid the process.

Stress can be physical or mental. Stress can be generated from unpleasant situations. But did you know that stress can also be produced by pleasant phenomena? The actual causative agent in the production of stress is simply a change from the status quo. Death of a spouse, divorce or getting fired from your job could all produce stress; so could marital reconciliation, retirement or an outstanding personal achievement.

Stress in and of itself is neither good nor bad. A moderate amount of stress is necessary for any achievement or increased productivity. Stress has a negative effect only when your ability to cope is exceeded. *Stress Evaluator* helps you determine your coping ability with a separate questionnaire. The program queries you on your virtues and your vices. Are you stubborn? Are you tolerant? Do you get upset easily? Your inmost secrets will be laid bare! Naturally, the CoCo will keep strict confidentiality.

After evaluating your ability to cope, *Stress Evaluator* will help determine your comfort or discomfort levels. You will be able to know whether to balance your level of comfort/discomfort for increased productivity or perhaps you need greater relaxation. For example, a boxer in the 15th round is likely to be experiencing great discomfort but high productivity in going the distance. If your coping ability is high, you, too, may wish to *increase* your discomfort level on the job thereby increasing your

# COMPUKIDS MAGAZINE

### The Computer Magazine for Beginners

Educational articles that are easy to understand  
Game programs  
Computer book reviews  
Program problems

### CompuKids Club

1 year magazine subscription  
Contests with GREAT prizes  
Free computer advice  
Program exchange  
Educational programs  
... and lots more ...

- One year subscription *plus* one year membership in CompuKids Club — \$24.00 (Canada — \$31.00)
- One year subscription only — \$16.00 (Canada — \$20.00)
- Six month trial subscription — \$9.00 (Canada — \$11.00)
- Payment enclosed (check or money order)
- Please bill me later (a \$1.00 billing fee will be added)

(Special School and Group Rates Available)

Name \_\_\_\_\_ Age \_\_\_\_\_ Signature if billing \_\_\_\_\_

Address \_\_\_\_\_ City \_\_\_\_\_ State \_\_\_\_\_

Zip Code \_\_\_\_\_ Phone \_\_\_\_\_

#### Mail Check or Money Order to:

CompuKids Magazine <sup>®</sup>  
P.O. Box 874  
Sedalia, MO 65301

Or Phone TOLL FREE:  
1-800-822-KIDS

productivity. If your coping ability is low, it may be wise to decrease discomfort to avoid possible health problems.

Finally, the simple meditation technique (rhythmic breathing) provided with *Stress Evaluator* may be useful to those who wish to increase their coping ability. A sinusoidal wave form is presented on the graphics screen. You inhale on the rising portion of the curve and exhale on the falling portion of the curve. Very simple indeed! But relaxing.

I found the *Stress Evaluator* relatively easy to use. The colorful graphics output added much to the stress evaluation session. Another useful feature was the printer output of the various stress and coping factors. The software is self-documenting to the point that some users may find the extra written instructions superfluous. For the uninitiated, however, here is a hint: the software is loaded in three separate Extended BASIC programs. Each section must be started by typing the *RUN* command. The main program will tell you that another section is loading. When the load is complete, the Color Computer will print out its familiar OK. That is when you type *RUN* again.

Extended BASIC is required with at least 16K of memory.  
(Petrocci Freelance Associates, 651 N. Houghton Road,  
Tucson, AZ 85748, \$24.95 on cassette)

—Dr. Laurence D. Preble

Hackers Helper...

## This Routine Draws Circles Around The Rest, Randomly

This month's Hackers Helper comes all the way from Humboldt, Saskatchewan, Canada—which, being north of

Moose Jaw and east of Saskatoon, is farther from more places than most places.

Karl Germann, of Humboldt, writes, "This program is designed to shorten time and save memory by inputting all circle positions in a data statement... Use this method and I guarantee you that it will be worth the effort."

The secret to the beautiful patterns generated by the routine is the random coloring. The main purpose of the program is the *READ, DATA* statements. These are easy to execute and run at impressive speed.

Karl is 15 and reports he has just begun experimenting with CoCo. Keep on keeping on, Karl!

The listing:

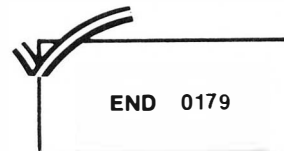

```

1 'BY:KARL GERMANN,BOX 2222,HUMB
OLDT,SASK.,S0K 2A0,CANADA
10 PMODE3,1:PCLS:SCREEN1,0
15 READ R,D:IF R=0 AND D=0 THEN
RESTORE:GOTO10
20 FOR PP=2 TO 16:FOR T=0 TO D S
TEP PP:C=RND(3)+1:CIRCLE(128,96)
,T,C,R:NEXTT,PP
25 FOR T=1 TO 500:NEXT:GOTO10
100 DATA.1,128,.2,128,.3,128,.4,
128,.5,128,.6,128,.7,.128,.8,128
,.9,128,1,96,1.1,90,1.2,84,1.3,8
0,1.4,74,1.5,68,1.6,64,1.7,60,1.
8,58,1.9,56,2,54,2.1,50,2.2,46,2
.3,40,2.4,36,2.5,32,0,0

```

### TRS-80\* COLOR COMPUTER\*

- 16K Extended Basic, Menu-Driven, Well-Documented, Easily-Modified.
- For either cassette or diskette systems (Be sure to specify).
- Place an order of at least \$40 and get one extra of your choice free.
- Orders shipped on cassette - Add \$5 for shipment on diskette.

#### -FURST-



Data Element Dictionary driven File Update and Retrieval SysTem. Create and maintain files according to your specifications. Ideas for applications included. .... \$25

#### -MAILING LABELS-



Generate and maintain mailing label records. Selectively print desired quantities. Can keep several label files if desired. Designed for Printer VII, easily modified. \$20

#### -REPORT WRITER-



Used in conjunction with FURST to selectively format reports on your printer. Includes headings and total capabilities. .... \$15

#### -EXERCISE PLANNER-



Build and maintain complete exercise schedule for regular and/or weight programs. Display guides you through daily-calculated routines. Print complete schedule if desired. .... \$15

#### -DISK DIRECTORY PRINT-



For diskette users only. Get hard copy of disk directories on your printer for easy use and reference. Only \$5

Send check or money order to:



**LAND SYSTEMS**

P.O. Box 232  
Bellbrook, Ohio 45305



\*TRS-80 and COLOR COMPUTER are Trademarks of Tandy Corp.

# Let's Look At Keyboard Input

By Richard A. White

Virtually all but the simplest programs are going to have to get some information from the user. This information can come from the keyboard, the joystick, a tape file, a disk file, or some combination of these. First, let's look at input from the keyboard. It is the first input source the new programmer encounters. There are actually two considerations, how to input data and how to test and use data immediately after it is input. Test? You've never hit the wrong key? Or, if you have and nothing happened, the program tested your response, didn't like it and gave you another chance. How data is input may be determined by how we are going to test and respond to the input.

Color Basic provides *INPUT* and *INKEY\$* commands for keyboard input. Extended Basic adds *LINE INPUT*. Let's dissect them. Following are a number of *INPUT* examples:

```
INPUT IS
INPUT I
INPUT "A CHARACTER STRING":IS
INPUT "ENTER NAME, AGE, WEIGHT AND
TELEPHONE":NAS,A,W,TL$
```

*INPUT* will accept either a character string or a numeric variable. In accepting a string, it will take up to the number of characters the keyboard buffer will accept. Any number up to 1.70E38 may be entered. Numbers larger than this will cause an OV ERROR (overflow) message as the program crashes. A string can be used with *INPUT* to print a message, generally a description of the data to be entered. When the program encounters an *INPUT* statement, it prints whatever character string it is given and a "?". It then waits for a keyboard response. Note that a number of variables may be strung out after an *INPUT*. In the fourth example, the user could have responded:

```
?Jones,29,182,900-6782(ENTER).
```

Each time *INPUT* sees a comma or an *ENTER* it considers it the end of data for the variable it is working on. An alternate user response is to hit *ENTER* after each data item. In this case, *INPUT* prompts with a double question mark (??) for the next item it needs. Here is an example.

```
NAME, AGE, WEIGHT, TELEPHONE ? Jones
?? 26
?? 182
?? 900-6782
```

*INPUT* is not for all occasions because of a few characteristics that can be problems. It will not accept commas or colons in a string entry and is of mixed mind about dealing with quotation marks. It also forgets leading blanks. Finally, when the *ENTER* is pressed, the rest of the line is blanked and the cursor goes to the beginning of the next line. This can be a hair pulling event when you have spent time making an input menu super neat with color background and borders and the *INPUT* wipes part of it out. For the beginning programmer, pretty menus are off in the future. My advice is to learn, and use, *INPUT* though you will probably want to use *LINE INPUT* or *INKEY\$* for most future keyboard entry. You will need it for tape and disk file handling.

We said that commas, quotes and colons give string input problems. Let's look at a few quirks when inputting numbers. One nice one is that *INPUT* overlooks spaces in a numerical entry. You can answer the "?" with 100 247 89; and *INPUT* will make I = 100247892 as if you had typed it that way. Entering a number with spaces can be easier an improve entry accuracy. However if your finger slips so that what you enter is 100 24U 892 *INPUT* will quit when comes to the "U" and return a stern ?REDO. Now this okay if you're entering screen format. But if you have two three variables after an *INPUT* and the error is in the third one, *INPUT* throws out all and starts over with ?REDO. A natural inclination would be to re-*ENTER* the offending entry, but *INPUT* wants all of them over again.

How does one find things like this out? With simple experimentation. You can learn most of what you need to know about how *INPUT* works by playing with the one line program below. It is listed along with a sample session of inputs and results. So, fire up CoCo and push keys with me.

Tired of simplistic Printouts? Want to use your printer's full capacity?

## AT LAST AT LAST

- \* Useful programs for the RS Color Computer
- \* Home & Small Business
- \* Customized for your printer
- \* Easy to use

BUDGET - income & expenditure by month & category Great for taxes	\$17.95*#
REMINDER LIST - the most complete list you will ever have	17.95 #
APPOINTMENT BOOK - Print an appointment calendar with any number of memos	17.95*
CALORIE COUNTER - automatically helps you diet	17.95
WEIGHT GRAPH - graph your daily weight	14.95
ADDRESS LISTER - makes labels, printouts & alphabetized lists	17.95 #
CAR REPAIRS AND MAINTENANCE LOG - graph when maintenance is needed & keep track of repairs	17.95*#
SALES RECORD - List item, date ordered, delivered, client, prices	14.95
PHONE BOOK - Alphabetical list to keep with you	14.95

Programs supplied on disk - add \$4.00 shipping, handling & disk/cassette charge.  
DISCOUNT: \$3.00 off second program \$4.00 off all others ordered at same time. \$110.00 for complete package postpaid. Specify: 16-32K, Cassette or RS disk.  
Type of printer - if possible and send xerox printer manual specifying control codes.

## FREE FREE FREE

Grocery list program (14.95 value) with SASE  
Supplied on disk/cassette with order

Catalogue Available

CALL or WRITE  
BRUCK ASSOCIATES  
6609 Westmoreland Ave.  
Takoma Park, MD 20912  
(301) 270-5822



\* Requires printer with compressed character capability.  
# 32 K recommended

```

10 INPUT I$,J: PRINT I$,J: GOTO10
OK
RUN
? "TEST",9 <ENTER>
TEST          9 (INPUT stripped off the quotes)
? "TEST"-2,9 <ENTER>
? REDO          (INPUT must not like material in and out
                of quotes mixed.)
? 3-"TEST",9 <ENTER>
3-"TEST"      9 (But, it took this and kept the quotes as
                well.)
? 4-"TEST":9 <ENTER>
4-"TEST"      9 (Commas and colons act the same.)
? 5-"TEST:9:SOMETHING <ENTER>
? EXTRA IGNORED
5-"TEST"      9 (INPUT wanted data for two variables, and
                that all it took.)
? 6-"TEST" <ENTER>
??           (Data for only one variable was entered.)
?? 9 <ENTER>
6-"TEST"      9 (Now all is in.)
? 7-"TEST",10000E34 <ENTER>
7-"TEST"      1E38 (Basic has its own styles for numbers-)
? 8-"TEST",1E40
? OV ERROR IN 10 (as long as the numbers are not out of
                limits.)

```

There is no way to keep the user from typing a number that is larger than 1.7E38 mentioned above and bombing the

program. There are ways through character input and testing to avoid damage and we will get to these later.

## TRS-80® COLOR COMPUTER® SWIVEL ORGANIZER

### A REAL VALUE!

ATTRACTIVE AND SOLIDLY BUILT THIS ALL-IN-ONE ORGANIZER IS THE PERFECT WAY TO LEND A PROFESSIONAL INTEGRATED LOOK TO YOUR CC

### CHECK THESE FEATURES!

- Water/stain resistant woodgrain laminate over 1/2" plywood
- Metal ball bearing swivel base permits sharing of the computer while still seated. Great for game playing and multi-use work stations
- Allows TV monitor mounting directly over computer to conserve space
- Storage area in rear with clamps for dressing cables neatly
- Comes fully assembled

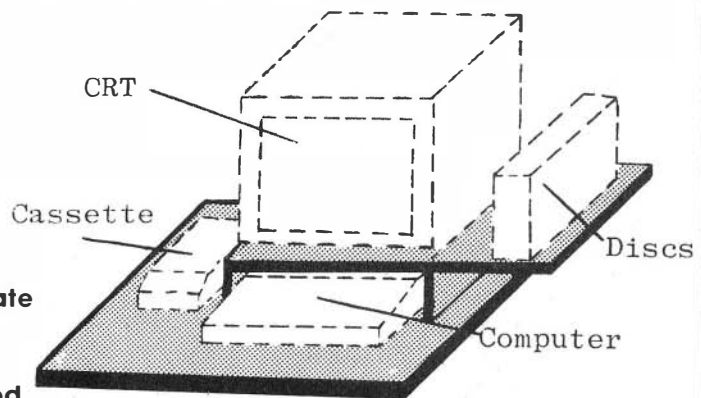

**\$34<sup>95</sup>**  
PLUS SHIPPING

Send Check Or Money Order To:

**SHAUNTRONICS** P.O. BOX 131  
FAIRVIEW, N.J. 07022

N.J. RESIDENTS ADD 5% TAX

TRS-80 & COLOR COMPUTER TRADEMARKS OF TANDY CORP.



*LINE INPUT* accepts only string inputs, one only at a time. Any keyboard character can be typed and *LINE INPUT* will take it. Since the characters are stored in the keyboard buffer before *ENTERing*, the back space acts to erase typed characters and will not be stored, nor will the erased characters. If you are writing a word processing or data management program in BASIC, *LINE INPUT* is mandatory for keyboard input. Try writing English without commas. For these applications, you most likely would find a "?" printed before each entry a pain, so *LINE INPUT*

omits printing the "?". If you want a question mark, you have to put it into your character string. Only the following two forms for *LINE INPUT* are allowed. Note that a space between *LINE* and *INPUT* is optional.

```
LINEINPUT I$
LINE INPUT "A CHARACTER STRING";I$
```

*LINEINPUT I* will cause a TM ERROR when data is entered and does not cause a SN ERROR. To see what *LINEPUT* can do experiment with the following program.

```
10 LINEINPUT"DATA";I$
20PRINT I$, :PRINT VAL(I$) :GOTO10
OK
RUN
DATA <ENTER>
                                0      (I$ contains only a carriage
                                return which VAL calls a 0)

DATA "TEST",,:"TEST" <ENTER>
"TEST",,:"TEST" 0      (Val calls any non-numeral a 0.
                        The text, commas, colons and all
                        was stored and printed as
                        entered.)

DATA 1123R456 <ENTER>
1123R456      1123 (VAL stops converting to a number
                  when it sees a non numeral.
                  We need error trapping.)

DATA 1123E22 <ENTER>
1123E22      1.123E25 (VAL treats an "E" as scientific
                       notation.)

DATA 1123E40 <ENTER>
OV ERROR IN LINE 20      (We need error trapping.)
```

Our experiments above have shown how we can enter nearly any keyboard character into a string using *LINE INPUT*. I leave it to the reader to experiment further and try to prove otherwise. We also built some conversion to numbers into the demonstration. We can do the same thing with converting an *INPUT* produced string to a number with identical results. The program bombs only when we try to convert a string to a number larger than 1.7E38. A keying error like "234U" will not be detected without added code. We would need to take a string apart and test it piece by piece for errors and ask for re-entry if all is not right. You need to make a decision on how important error trapping and user proofing of inputs are. There are two levels. One is catching data errors. The other is catching errors that will break the program and which are much more important to find.

Generally, input testing is best done on a character by character basis, though each need must be evaluated individually. Where user proofing or testing a short sequence of characters is the objective, *INKEY\$* is a convenient tool. Its syntax is *Z\$=INKEY\$*. *INKEY\$* checks to see what if any key has been pressed since the last *INKEY\$* and program execution proceeds. If there has been a keystroke, *Z\$* will contain the character, otherwise *Z\$=""*. Since program execution proceeds, it is generally necessary to put *INKEY\$* in a loop that is exited only when a key is pressed. In other cases, generally games, the loop will contain code causing continuing actions on the screen as well as the *INKEY* sampling so that the program does not wait for a player's response, but checks frequently to see if there is one. Below is a typical data input *INKEY* loop.

```
10 Z$=INKEY$ :IF Z$="" THEN 10 ELSE RETURN
```

**Now! THE MOST COMPLETE LIST OF  
EDUCATIONAL COLOR COMPUTER™  
PROGRAMS IN THE UNITED STATES**

Only **\$6<sup>00</sup>** per cassette

**A partial list —**

- Add
- Algebra
- Alphabet
- Planetary Positions
- Flash cards for German, French, Spanish, States and Capitals
- Biology
- Weather Forecaster
- Physics

Programs for — TRS 80 Color Computer,  
VIC 20, Atari 400, Timex-Sinclair

**Many more!** From Kindergarten through graduate courses. All cassettes \$6<sup>00</sup> each. Write for free list.

**MOSES ENGINEERING COMPANY**

P. O. Box 11038 • Ardmore Hwy. Station  
Huntsville, Alabama 35805  
(205) 837-3356

**AARDVARK**  
**TRS-80 COLOR    COMMODORE 24    VIC-20    SINCLAIR/TIMEX    TI99**



**QUEST** — A NEW IDEA IN ADVENTURE GAMES! Different from all the others. Quest is played on a computer generated map of Alesia. Your job is to gather men and supplies by combat, bargaining, exploration of ruins and temples and outright banditry. When your force is strong enough, you attack the Citadel of Moorlock in a life or death battle to the finish. Playable in 2 to 5 hours, this one is different every time. 16k TI99, TRS-80 Color, and Sinclair, 13K VIC-20. \$14.95 each.

32K TRS 80 COLOR Version \$24.95.  
 Adds a second level with dungeons and more Questing.



**CATERPILLAR**

O.K., the Caterpillar does look a lot like a Centipede. We have spiders, falling fleas, monsters traipsing across the screen, poison mushrooms, and a lot of other familiar stuff. COLOR 80 requires 16k and Joysticks. This is Edson's best game to date. \$19.95 for TRS 80 COLOR.



**ADVENTURES!!!**

The Adventures below are written in BASIC, are full featured, fast action, full plotted adventures that take 30-50 hours to play. (Adventures are interactive fantasies. It's like reading a book except that you are the main character as you give the computer, commands like "Look in the Coffin" and "Light the torch.")

Adventuring requires 16k on Sinclair, TRS-80, and TRS-80 Color. They require 8k on OSI and 13k on VIC-20. Sinclair requires extended BASIC. Now available for TI99. Any Commodore 64.  
 \$14.95 Tape — \$19.95 Disk.

**ESCAPE FROM MARS**

(by Rodger Olsen)

This ADVENTURE takes place on the RED PLANET. You'll have to explore a Martian city and deal with possibly hostile aliens to survive this one. A good first adventure.

**PYRAMID** (by Rodger Olsen)

This is our most challenging ADVENTURE. It is a treasure hunt in a pyramid full of problems. Exciting and tough!

**DERELICT**

(by Rodger Olsen & Bob Anderson)

New winner in the toughest adventure from Aardvark sweepstakes. This one takes place on an alien ship that has been deserted for a thousand years — and is still dangerous!

**Dungeons of Death** — Just for the 16k TRS-80 COLOR, this is the first D&D type game good enough to qualify at Aardvark. This is serious D&D that allows 1 to 6 players to go on a Dragon Hunting, Monster Killing, Dungeon Exploring Quest. Played on an on-screen map, you get a choice of race and character (Human, Dwarf, Soldier, Wizard, etc.), a chance to grow from game to game, and a 15 page manual. At the normal price for an Adventure (\$14.95 tape, \$19.95 disk), this is a giveaway.

**WIZARDS TOWER** — This is very similar to Quest (see above). We added wizards, magic, dragons, and dungeons to come up with a Quest with a D&D flavor. It requires 16k extended color BASIC. \$14.95 Tape, \$19.95 Disk. VIC 20 Commodore 64.



**NEW**

**PLANET RAIDERS** — Not just another defenders copy, this is an original program good in its own right. You pilot a one man ship across a planetary surface dogfighting with alien ships and blasting ground installations while you rescue stranded troopers. Rescue all the troopers and be transported to another harder, faster battle. Joysticks required. ALL MACHINE CODE! EDSONS BEST! 16K Tape TRS80COLOR \$19.95 — 32K Disk \$21.95.

**BASIC THAT ZOOMS!!**

**AT LAST AN AFFORDABLE COMPILER!**

The compiler allows you to write your programs in easy BASIC and then automatically generates a machine code equivalent that runs 50 to 150 times faster.

It does have some limitations. It takes at least 8k of RAM to run the compiler and it does only support a subset of BASIC—about 20 commands including FOR, NEXT, END, GOSUB, GOTO, IF, THEN, RETURN, END, PRINT, STOP, USR (X), PEEK, POKE, \*, /, +, -, >, <, =, VARIABLE NAMES A-Z, SUBSCRIPTED VARIABLES, and INTEGER NUMBERS FORM 0-64K.

**TINY COMPILER** is written in BASIC. It generates native, relocatable 6502 or 6809 code. It comes with a 20-page manual and can be modified or augmented by the user. \$24.95 on tape or disk for OSI, TRS-80 Color, VIC 20, or Commodore 64.

**SEAWOLFE** — ALL MACHINE CODE In this high speed arcade game, you lay out patterns of torpedoes ahead of the attacking PT boats. Requires Joysticks, at least 13k RAM, and fast reflexes. Lots of Color and Sound. A fun game. Tape or Disk for Vic20, Commodore 64, and TRS-80 Color.  
 \$14.95 Tape - \$19.95 Disk.

**Dealers** — We have the best deal going for you. Good discounts, exchange programs, and factory support. Send for Dealer Information.

**Authors** — Aardvark pays the highest commissions in the industry and gives programs the widest possible advertising coverage. Send a Self Addressed Stamped Envelope for our Authors Information Package.

**Adventures and Quest now available for TI99**

*Please specify system on all orders*

**ALSO FROM AARDVARK** — This is only a partial list of what we carry. We have a lot of other games (particularly for the TRS-80 Color and OSI), business programs, blank tapes and disks and hardware. Send \$1.00 for our complete catalog.

**AARDVARK**

**2352 S. Commerce, Walled Lake, MI 48088 / (313) 669-3110**

**Phone Orders Accepted 8:00 a.m. to 4:00 p.m. EST. Mon.-Fri.**

**\$2.00 shipping on each order**



*INKEY\$* may be used frequently in a program for a variety of purposes and is profitably placed in a low numbered subroutine for speed and memory saving. The code should also be kept to its simplest form with most data manipulations done by the calling routine. One exception is to convert *Z\$* to the number *Z* since numbers are frequently used as responses to menus and then decoded using *ON Z GOTO* frequently used as responses to menus and then decoded using *ON Z GOSUB* statements. The following modification fills the bill.

```
10 Z$=INKEY$ :IF Z$="" THEN 10 ELSE Z=VAL(Z$)
:RETURN
```

Now that we have a single character input, how can we use it. The simplest application is to get and act on a single keystroke response to a menu.

#### MAIN MENU

1. INPUT
2. PRINT
3. LOAD
4. SAVE
5. QUIT

If line 1000 printed the menu, the next lines might be as follows.

```
1010 GOSUB10 :ON Z GOTO 100, 200, 300, 400, 500
1020 GOTO1010
```

If *Z* is greater than five, or *Z* equals zero, the program goes to 1020, which goes back to 1010 to get a new entry.

The use of a command line at the top or bottom of a working screen is a user-friendly device to remind the user what control options are available and the keystrokes required to invoke one. In an example from an information management program, the user has just finished entering a record, in either upper or lower case mode, and needs to tell the program what to do next. Options are to continue data entry, modify the record just entered or return to the main menu. This command line is presented:

```
cONTINUE mODIFY rETURN
```

The lower case (reverse video) signals the key to press for each function. Now we need to convert one of the letters "c, C, m, M, r, R" to an action. A neat way to do this that avoids a bunch of *IF THEN* statements is to use *INSTR* as follows:

```
250 GOSUB10 :Z = INSTR(1, "cCmMrR",Z$) :
ON Z GOTO 200, 200, 500, 500, 1000, 1000
255 GOTO250
```

If *Z\$* is not one of the control letters, *INSTR* returns a 0 and the program tries again (Line 255). If a valid letter is returned, *INSTR* returns its count up the string and this number can be used directly in an *ON Z GOTO* or *GOSUB*. The Syntax of *INSTR* is fairly straightforward, the "1" tells *INSTR* to start at the first character of the string. Sorry Color BASIC people, *INSTR* is one of those Extended BASIC jewels, but you can write a short subroutine using *MID\$* to do the same thing. Our Apple friends have to do that all the time.

Another testing task might be to see that only numerals or a period are entered into an accounting routine and recognize the carriage return to end the input. Here is code to do this:

```
250 GOSUB10 :Z = INSTR(1,"234567890.",Z$) :IF Z 0
THEN
PRINT Z$; :A$=A$+Z$ :GOTO250 ELSE
IF Z=0 AND Z$()CHR$(13) THEN 250
```

Here if *Z\$* is a number or a period, *Z\$* is added to *A\$* and *Z\$* is printed to the screen with a semicolon to hold the cursor. If *Z\$* is not a number and it is not a carriage return, the program disregards the input and goes back for another character. The only other possible case is that *Z\$* is a carriage return and the program goes to the next step.

Routines like this which are continually getting a character and adding it to a string generate a lot of garbage in string space. The program must stop occasionally for the computer to clean things up and make room for new strings. This is a major reason not to use *INKEY\$* for extensive string entry such as in a word processor or data file program.

Now for the homework assignment. Suppose you have written a Bulletin Board program and some jerk at the other end of the phone line has discovered he can crash your program by answering 1E40 when the program asks for the number of the message to be read. Write an input and error trapping routine to recognize and discard an out of limits number. Assume that your Bulletin Board is so good that you expect 10E30 messages over the next ten years. (If you believe that, I have a bridge for sale!) The best routine(s) sent to *the Rainbow* will be published in a later BITS AND BYTES OF BASIC.



## CANADIANS! GET YOUR SOFTWARE HERE IN CANADA

*No Hassle, No Duty and  
No Converting the Dollar*

*Soft Sector Marketing*

GALAX ATTAX	\$26.95
SPACE WAR	\$26.95
COLOR SPACE INVADERS	\$26.95
METEOROIDS	\$26.95
KEYS OF THE WIZARD	\$24.95
WAR KINGS	\$24.95
MOON LANDER	\$20.95

All Prices In Canadian Dollars

**We also have Computerware and  
Mark Data Products**

**Order Now or write for our  
complete software list.  
TABBY ENTERPRISES**

Box 1353 R.R. 1  
Yarmouth, Nova Scotia  
B5A 4A5  
(902) 649-2965

## Frog Trek Hops Over High And Low Ground

*Frog Trek* is a program based on the arcade game *Frogger*. The object of *Frog Trek* is to guide your frog (using the keyboard) from the left side of the screen to the right side, without getting killed in the process. Sound easy? It really isn't, since you must shift your way through six lanes of rush hour traffic, dodge a threatening snake and hop from logs to turtles to the frog's home. Once four frogs reach their destinations, a new screen is drawn with faster traffic and a faster river current. After many hours of playing, I was only able to accomplish this screen once.

As is the case in most computer programs, *Frog Trek*, which requires 16K, has its good and bad qualities. Here are a few features and disappointments contained within this machine language program.

**Graphics**—The Graphics in *Frog Trek* are one of the program's attributes. The shapes are very clear and distinct: the frog looks like a frog, the turtles look like turtles, etc. Despite the many objects moving on the screen at once, there is no flicker. The program's author did a good job with the graphics in this game.

**Sound**—Sound is a vital part of any arcade program. Unfortunately, *Frog Trek* falls short in this area - nothing but short beeps and long beeps of different pitches. The documentations says that "if you succeed in bringing froggie home he will reward you with a friendly RIBB-IT." To me, this "RIBB-IT" seemed more like an alarm clock sounding off. I personally feel that the sounds should have been developed more thoroughly.

**Documentation**—The instructions included with this game are adequate. They tell how to play the game in an

understandable manner. There were a couple of things I found missing from the documentation. There was no mention of scoring. I had to figure this out myself. Also, there wasn't any statement regarding the purpose of the timer. I believe the directions can be improved.

**Bugs In The Program**—To be honest, *Frog Trek* needs some major debugging. The bugs aren't that major in the game play, but at times are quite distracting. There are three problems worth noting. First, a few words of instructions are displayed before each game. This is fine, but the problem is the way it is written on the screen. It is shown like this:

USE ARROWKEYS TO CONTROL THE FROG  
HIT ANY KEY TO START GAME

I feel a quality computer program shouldn't have this program. A few more programming instructions would have cured this silly mistake. Second, once the timer runs down from sixty to zero, the computer thinks that the frog has reached its home. You are awarded 90 points, the frog goes back to the start, and best of all, your frog doesn't die. I don't mind this, but I would have found the game more challenging played against time. Finally, the problem I found most distracting was something that prohibits your frog from getting across sometimes. Once your frog reaches the middle island, it must jump from log to turtle. Well, sometimes the frog lands directly on top of the log or turtle and dies. Other times, the frog is not quite on the object and lives. This became more frustrating the more I played.

Despite these problems, I found *Frog Trek* to be enough of a challenge for the price. It seems to me that the author rushed his product out onto the market a little too quickly. If he were to work on his program a bit, and take some time debugging it, *Frog Trek* could be turned from a good program into a great one.

(Oelrich Publications, 4040 N. Nashville Ave., Chicago, IL 60634, \$14.95)

—Ken Coleman

<p>P.O. Box 513 LASALLE QUE. H8P 3J4 CANADA</p>	<p><b>! CANADIANS ! F &amp; T SOFTWARE</b></p>	<p><b>Inquiries and Orders Call (516) 365-5392 Between 1-7 p.m. (E.S.T.)</b></p>
<p>We are Canada's largest importer of software for the Color Computer!</p> <ul style="list-style-type: none"> <li>★ Avoid the hassles and surcharges of importing directly from the U.S.</li> <li>★ Avoid Customs Problems.</li> <li>★ Save Time and Money.</li> </ul> <p>Choose from our vast selection of quality software and pay in <b>CDN FUNDS.</b></p> <p><b>ORDERS:</b> Write or call us</p> <ul style="list-style-type: none"> <li>★ Personal cheques O.K.</li> <li>★ COD's Under \$100 add \$1.50 (Postal Rate)</li> <li>★ Quebec Residents Only Add 9% Sales Tax</li> </ul> <p><b>CATALOGS:</b> Send \$1 (refundable on first order), we'll send you our present catalog and we will insert you in our mailing list for <b>free</b> future updates.</p>	<p>This Month F&amp;T Features <b>SPECTRAL ASSOCIATES</b></p> <p><b>NEW! KEYS OF THE WIZARD</b> Super new text Adventure game, three skill levels and a cassette save feature. An Extremely challenging and gripping game! Clues provided on request. 16K Cassette <b>CDN \$26.00</b></p> <p><b>NEW! GALAX ATTAX</b> Fast, challenging action game with rows of alien attackers swooping down on your ship! Bonus ships. Highest resolution. Machine Language. 16K Cassette <b>CDN \$28.00</b></p> <p><b>SPACE WAR</b> Command only remaining combat viper and break through enemy fighters and the Death Star! Highest resolution. Machine Language. We consider it a classic! 16K Cassette <b>CDN \$29.50</b></p>	<p><b>UTILITIES</b></p> <p>Compuvoice <b>CDN \$55.00</b> Soundsource &amp; Cable <b>CDN \$33.00</b> Bugout Monitor <b>CDN \$28.00</b> Magic Box <b>CDN \$33.00</b></p> <p><b>GAMES</b></p> <p><b>NEW</b> Planet Invasion <b>CDN \$28.00</b> Defense <b>CDN \$28.00</b> CCThelo <b>CDN \$21.00</b></p> <p><b>ALSO</b> Laser Command <b>CDN \$17.50</b> Cosmic Super Bowl <b>CDN \$22.00</b> Minotar <b>CDN \$27.50</b> Ghost Gobbler <b>CDN \$29.50</b> Graphic Animator <b>CDN \$17.00</b></p> <p><b>BOOKS</b></p> <p>Spectral—The Facts <b>CDN \$22.00</b> McGraw-Hill—6809 Assembly Language Programming <b>CDN \$24.00</b> ArcSoft—101 Program Tips &amp; Tricks for the Color Computer <b>CDN \$14.00</b></p>
<p><b>FREE SHIPPING &amp; HANDLING — NO HIDDEN CHARGES — CANADIAN \$\$</b></p>		





## 4K, Non-Extended Tutor Spells 'Help'

By Ronald Pesha

Here is a program I developed to help my 10-year-old son practice his spelling. It is unusual, as I see it, in that the words are spoken to the child. It also scores the child and prints out the scoring at the end.

An important aspect of this program is that it requires only regular, not Extended, Color BASIC, and 4K is more than adequate. A cassette recorder is required, and two cassettes. Load the program on one cassette, using your own list of words. I have put a sample list of 20 spelling words in the program beginning with Line 100; just use *DATA* at Lines 100 to 119 at the rate of five words per line. If your list of spelling words has more or fewer words than 20, you will also need to change Line 130 and Line 220 as explained by the *REMARK* after each.

Now place a fresh cassette in the recorder and *ENTER* RUN 1000. Just follow the instructions. Speak the list of spelling words, in exactly the same order, into the microphone, following the instructions which will appear on the screen. You'll find that it is easy to change this cassette and the *DATA* lines in the program each week for the child to practice.

Type the program listing with spaces exactly as shown for the best appearance on the screen.

The listing:

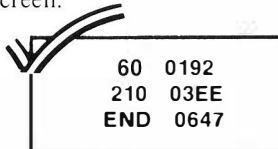

```

1 REM USE SEPARATE CASSETTES FOR
RECORDING PROGRAM AND AURAL WORD
LIST
2 CLS
3 Y=0:Z=0
4 AUDIO ON
5 PRINT @ 7, "SPELLING TEST": PR
INT
10 PRINT "BE SURE CASSETTE IS RE
WOUND AND TAPE MACHINE IS IN 'PL
AY' MODE.": PRINT
12 PRINT "BE SURE VOLUME CONTROL
ON TV IS TURNED UP.": PRINT
15 INPUT "PRESS <ENTER> WHEN YOU
'RE READY, THEN WAIT TILL COMPUTE
R ASKS YOUFOR CORRECT SPELLING."
;E$
20 CLS
30 MOTOR ON
40 FOR X = 1 TO 1800
50 NEXT X
60 MOTOR OFF
70 INPUT "HOW DO YOU SPELL IT";A
$
90 REM TO CHANGE WORD LIST TYPE
NEW WORDS AFTER 'DATA' - 3 WORDS
PER LINE.
    
```

```

100 DATA TOBOGGAN, INDIAN, CABIN
, PELICAN, BUTTON
101 DATA CANNON, DRAGON, PARDON,
RIBBON, WAGON
102 DATA EATEN, GIVEN, HIDDEN, R
IDDEN, OLDEN
103 DATA MITTEN, HEAVEN, OFTEN,
SALMON, MOCCASIN
120 READ F$
121 Y=Y+1
125 IF A$=F$ THEN GOTO 130 ELSE
GOTO 200
130 IF Y=20 GOTO 140
131 REM THE NUMBER IN "Y= " IN
LINE 130 SHOULD BE THE SAME AS
THE NUMBER OF WORDS IN THE LIST.
SAME IN LINE 220.
132 PRINT
133 INPUT "CORRECT. PRESS <ENTER
> FOR NEXT WORD.";E$
135 GOTO 20
140 PRINT "          CORRECT":GOT
O 300
200 PRINT "WRONG. IT IS SPELLED
"F$:PRINT
210 Z=Z+1
220 IF Y=20 GOTO 305
230 INPUT "PRESS <ENTER> FOR NEX
T WORD";E$
240 GOTO 20
300 PRINT
305 PRINT
310 PRINT "          END OF TEST":
PRINT
320 PRINT "HERE IS YOUR SCORE IN
"Y"WORDS.":PRINT
330 PRINT "          INCORRECT:"Z
340 PRINT "          CORRECT:"Y-
Z
350 END
990 REM 1000 BEGINS ROUTINE FOR
RECORDING WORD LIST
1000 PRINT "PUT RECORDER IS RECO
RD MODE BUT WITH 'AUX' PLUG OUT
OF ITS JACK SO MICROPHONE IS ON.
":PRINT
1005 PRINT "TAPE RUNS 4 SECS. FO
R EACH WORD.":PRINT
1010 PRINT "WHEN WORD LIST IS RE
CORDED ENTER 'BREAK' AND REWIND T
APE.":PRINT
1020 INPUT "PUSH <ENTER> WHEN RE
ADY; WAIT 2 SECONDS AND SPEAK ON
E WORD.";E$
1025 CLS
1030 MOTOR ON
1040 FOR X = 1 TO 1840
1050 NEXT X
1060 MOTOR OFF
1070 GOTO 1010
    
```

## Atari Joystick Adapters Endorsed

What is your high score at *Donkey King*? What? Well, there goes that theory. I was assured that after using an Atari joystick with the CoCo, my game scores would show a remarkable improvement. The only problem is that I no longer have the dexterity of a 10-year-old, semi-professional game player. At the same time, I am strong enough to tear the stick right out of its socket in frustration. I would recommend to anyone who enjoys games on his CoCo, that he invest in an adapter for converting the Atari joystick to the CoCo.

Many different manufacturers are now producing plug-compatible interface units for the true game addicts who spend hours trying to squeeze another 100 points out of their computers. As I happened to have more invested in Atari cartridges than in my computer—well, almost—I was very interested in the operation of these units. Two similar units were reviewed. The first was a single stick interface termed *Top Stix* by International Software. The second was the *Double Stick Interface* by Spectrum Projects, featuring two joystick ports. The *Double*, as I call it, comes with optional Atari joysticks. Both units performed as they are advertised.

The *Double* is housed as a 4"x2"x1" heavy plastic box that contains the Atari jacks. This unit is connected by two 36-inch cables to the joystick ports in the rear of the CoCo.

To say the least, this unit is "quality" constructed. Unfortunately the *Top Stix* unit I reviewed is a demo, so I cannot comment on the final product.

Both units performed equally, but I picked up some extra noise on my TV screen with the *Double* in the line. After moving cables all over the place I gave up trying to completely eliminate the problem. I feel the extra lead length invites problems.

Now, for the problems. As you may have guessed, there are certain disadvantages to the use of an Atari joystick for certain games. The Atari units have switches instead of potentiometers inside the black box. What this means is that you don't have a linear or continuous output when you move the handle from right to left or top to bottom. Another way to look at it is to plug in your diagnostic program and look at the position of the joystick is either going to be in the middle of the screen or on one of the edges. There are no positions in between. What does this mean?

Well, for certain games, such as *Donkey King* or one of the Pac Man derivatives, where you just have to move to the right, left or up and down, it is insignificant, but what about *Polaris* or *Football*? These types of games require continuous (linear) motion.

In summary, I say again that I recommend these units to anyone interested in action games. After reviewing my software library I found very few games that would not be compatible with the Atari joystick. Also, in my opinion, the ruggedness of these joysticks is a consideration when compared to some other products on the market.

Now if I could only get to the second screen!

**(Double Stick Interface, Spectrum Projects, 93-15 86th Drive, Woodhaven, NY 11421, \$19.95**

**Top Stix, International Software Inc., 771 Hockley Ave., Victoria, B.C., Canada V9B 2V5, \$29.95)**

—Dan Downard

## ™ TRS80 color

From the January 1981 issue of the CSRA Computer Club newsletter.

There was some amusement at the November meeting when the Radio Shack representatives stated that the software in the ROM cartridges could not be copied. This month's 68 Micro Journal reported they had disassembled the programs on ROM by covering some of the connector pins with tape. They promise details next month. Never tell a hobbyist something can't be done! This magazine seems to be the only source so far of technical informations on the TRS-80 color computer™. Devoted to SS-50 6800 and 6809 machines up to now 68 Micro Journal plans to include the TRS-80 6809 unit in future issues.

NOTE: This and other interesting and needed articles for the Radio Shack TRS-80 color computer™ are being included monthly in 68 Micro Journal—The Largest specialty computer magazine in the world!

### 68 MICRO JOURNAL

5900 Cassandra Smith Road  
Hixson, Tennessee 37343  
615 842-4600

#### Subscription Rates

USA: 1-year \$24.50; 2-year \$42.50; 3-year \$64.50  
CANADA and MEXICO: Add \$5.50 per year to USA Price  
Foreign Surface: Add \$12.00 per year to USA Price  
Foreign AIRMAIL: Add \$36.00 per year to USA Price

\*\* Sample issue - \$3.50

'68' \$2.50

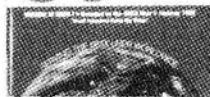

'68' \$2.50

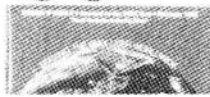

'68' \$2.50



68 Micro Journal™ was established with one objective in mind; to provide a Magazine FOR 68xx Users BY 68xx Users. Because of a strict advertiser policy, 68 Micro Journal™ has gained a strong following WORLDWIDE because the reader KNOWS what he is getting when purchasing from a 68 Micro Journal™ Advertiser. It has gained a strong user following because most of the material published is contributed BY USERS, and, therefore, is relevant to the Users needs.

Currently, and even before the Color Computer™ hit the stores, 68 Micro Journal™ was devoting more space to the TRS-80C Color Computer™ and information concerning the Motorola 6809 (which is the CPU in the Color Computer™) than ANY OTHER Computer Magazine. Examples include:

**REVIEWS** of the three major Disk Control Systems for the Color Computer™, most of the Monitors, Assemblers, and Disassemblers, Word Processors and Editors, "Terminal" Programs (for use with Modems, Communications with other Computers, etc.), and of course, Games.

**HINTS** for Expanding Memory, Power Supply Cooling, repairing sticky keyboards, disabling the ROM PAK "Take Over", hooking up to Printers, etc.

**DISCUSSIONS** of the 6883 Synchronous Address Multiplexer, using the Color Computer™ with 64K and 96K memory (which it is ALREADY capable of handling), thoughts on Programming, etc.

I suggest that you subscribe to 68 Micro Journal™, SOON, as many back issues are sold-out.

We still, and will continue to, lead in the type information you need to FULLY UTILIZE the POWER of the 6809 in the Radio Shack TRS-80 Color Computer™.

*Bob Nay*  
Bob Nay  
Color Computer Editor

## Bigfoot: More Board Game Than Adventure

"Deep in a dark and twisting maze, hiding in his lair, *Bigfoot* waits to ambush careless hunters who enter his domain."

So begins the documentation for the *Bigfoot* adventure. The object of this game is to find your way through a maze of rooms and passages to *Bigfoot's* hiding place and kill the monster. Along the way, you must avoid rooms filled with quicksand which immediately swallow you up into oblivion if you make the mistake of entering the room. Another potential hazard is a room with a giant bat. The bat may or may not be disturbed by your entering the room. If it is, it will pick you up and drop you randomly in another room. When you locate *Bigfoot* using the clues the game provides you get one shot to shoot into his lair and kill him. If you miss, the noise irritates him and he stomps on you—score one for the Sasquatch.

If you accidentally stumble into his lair, he stomps you before you can even think about shooting him. The game plays fairly quickly, usually taking less than five minutes to either kill or be killed. At the end of each round a three entry-score is displayed—"Hunter" (that's you), "Bigfoot," and "Quicksand."

Although the game is presented as a graphic adventure, it plays more like a video board game. The graphics do not display large rooms or dark passages. The rooms are small squares just large enough to hold the figure of the hunter.

The entire maze, which could consist of up to 42 rooms, will fit on one screen. The "dark and twisting passages" are connectors between these rooms. There are three levels of difficulty for the mazes and four types of "mapping" for the hunter's movement through the maze. In normal mapping, when you begin a new maze you are randomly placed into one of the rooms and that room and its position are the only things displayed on an otherwise blank screen. As you move by use of the arrow keys to other rooms, each new room you enter is added to the display. In blind mapping, only the room you are in is displayed—all others are blanked as soon as you leave them. The blind mapping is certainly more challenging, trying to remember the relative locations of the rooms you have explored and their clues to *Bigfoot's* location.

Besides myself, our family has three expert game critics—16-, 14-, and 12-year-old sons. When I polled the boys for their opinions, the 16-year-old said, "It's OK." The 14- and 12-year-olds agreed that it was "pretty good."

They, of course, have many friends to assist them in their game playing. The greatest interest in *Bigfoot* came from the 12- to 14-year-old group. If you are a true adventurer along the lines of *Colossal Cave* or the Scott Adams adventures, *Bigfoot* is not what you are looking for. If you are a board game enthusiast and appreciate the extra dimension that a computer can offer through its graphics and ability to dynamically control the board, you may enjoy *Bigfoot*.

*Bigfoot* is written in Extended Basic and requires 32K.

(Genesis Software, P.O. Box 936, Manchester, MO 63011, \$21.95 on tape)

—James G. Kriz

ACS

Post Office Box 15235  
Plantation, Florida  
33318

**All Color Software**

---

**New! from ACS . . .**

**Give your CoCo an**  
**On/Off light for \$5.00!!**  
**Will NOT Void Warranty!**



Now for only \$5 you can have an on/off light for your CoCo, without voiding your warranty!! If you own a joystick, can drill ONE hole, and make TWO connections, then you are ready for this simple Do-It-Yourself Kit!!

This simple kit comes with the parts to modify 2 joysticks, and clearly written instructions on the procedure, which takes only 10 minutes on the average.

Note: This modification Does NOT impede joystick performance. This kit works with any joystick, and is equally easy to install in each.

**ORDER NOW!!**

**NO Extra Shipping Charges!!**

Florida residents add 5% sales tax. Note: Custom joysticks still available.

## Here's One For You, Roy

Here's a short, no nonsense program that we're quite sure Roy G. Biv, wherever under the sun he may be, will heartily endorse. Thus, the editors of *the Rainbow*, after due deliberation and reflection, have tapped out **David A. Cromley**, of Cheyenne, Wyoming, as the first recipient of the Roy G. Biv Award.

While David is the very first to be recognized with this special citation, the editorial staff of *the Rainbow* fully intends to confer this acknowledgement of meritorious service to others who make significant contributions to the Color Computer community (or who send in nice little programs that we like and think would be helpful to our readers). We believe it is a fitting tribute to Roy G. Biv, whose legendary and colorful name is known by heart, associated with happiness and recalled with fondness by friendly people in all walks of life, most anywhere the sun shines and the rain falls.

In offering to share his short listing with *Rainbow* readers, David A. Cromley writes, "Here is a little utility I frequently use to check the adjustment of the TV set. It also helps when I can't remember what magenta and cyan look like. Hitting the keys '0' through '8' changes the background color."

Here at *the Rainbow*, we enjoy "program quickies" such as David's *ColorCk*, and we hope to receive and print a lot more of them.

*ColorCk!* It's not the NBC peacock, but it is this month's winner of the Roy G. Biv Award.



END 019C

The listing:

```

110 '---COLORCK, D CROMLEY
120 CLS B: RESTORE
130 FOR X4=0 TO 48 STEP 16
140 FOR X2=0 TO 32 STEP 32: K=X2
+X4*4
150 PRINT@74+X2,STRING$(12,CHR$(
128));
160 PRINT @132+K,STRING$(10,CHR$(
143+X4));
170 PRINT @146+K,STRING$(10,CHR$(
207+X4));
180 NEXT X2: READ S1$,S2$
190 PRINT@103+K,S1$;: PRINT@117+
K,S2$;
200 NEXT X4: PRINT@78,"ob1k";
210 PRINT @492,"BG COLOR?";
220 Q$=INKEY$: IF Q$="" THEN 220
230 IF Q$<"0" OR Q$>"8" THEN 220
240 B=ASC(Q$)-48: GOTO 120
250 DATA 1GRN,5BUF,2YEL,6CYN
260 DATA 3BLU,7MAG,4RED,8ORG 

```

# GET YOUR BUGS OFF YOUR HANDS.

Bugs in your programs can really get under your skin. Especially when they've been bugging you for longer than you'd like to think.

So get your bugs off your hands. And onto somebody else's.

Pack them off to DeBug. (On cassette, thank you.) With a description of where you were going. And where you got stuck. If it's an interesting enough program, we'll send it to people who like to stomp on other people's bugs.

If somebody can get all the bugs out of your 16K Extended Basic CoCo program, we'll try to sell it. And everyone shares the profits.

Send \$5 per entry. Or \$9 for a sample cassette of 20 or so very buggy programs. Or \$12 for both.

**DEBUG** 114 West Central St.  
Natick, MA 01760







## Create Character Files With This 'Finished' Program

By Bill Nolan  
Rainbow Contributing Editor

Welcome to the March column. I wish I could say that I finally did this early, but the fact is that as I sit here at my computer, word-processing away in an effort to spruce up this final draft, the people at Federal Express are only two hours away. Yes, the editor of this most respected magazine said "it absolutely, positively had to be there overnight." That's what I get for waiting until the last minute.

As you know, we have been developing a plan for our major record keeping program over the last two months, and the "finished" program is below. I put finished in quotes because I know that no program is ever really finished. The programmer may think it is...

### YOU'LL BE SORRY IF YOU DON'T READ THIS NEXT PART!

The program runs on a 16K Extended BASIC machine—

**OH NOOOO. . . .**

Someone said as I demo'd C. C. Calc at the last meeting of the Northern Illinois Computer Club, "I just spent twice as much for half as much." He bought a copy anyway.... Save, Load, and Merge files - Yes! User specified Decimal Points? - Yes! Can you calculate 3% of \$XX,XXX but not exceed \$150? (Sound like the IRS?) - Yes! Stuck with Row and Column formulas? Not with C.C.Calc! Every cell on the spreadsheet can have its own formula.

C. C. Calc is the full featured, Electronic Spreadsheet that's designed for maximum, user controlled, flexibility on the Color Computer. The Command Summary fills three pages of the documentation but in short you have all the arithmetic operators, summation, replication, calculation order, selected column prints, screen prints and more.

Now the Color Computer has Smarts to match its muscle. C.C.Calc is available on cassette or disk for a ridiculously low \$25.00. Requires 32K.

**C. C. Calc      \$25**

**TransTek  
194 Lockwood  
Bloomington, IL 60108**

barely! Before you type it in type *POKE 25,6:NEW* and *ENTER* to get the most memory, and then type this again every time before you load the program or you will get an *OM ERROR*. If you only have a 16K machine I recommend the following: Leave all *REM* lines out of the program (except line 11000—we jump to that one), and when it is all typed in and working, renumber it by typing *RENUM 0,0,1* and pressing enter. This will make more memory available. Of course you saved it to tape first in case the computer crashed while renumbering. You can then change the *CLEAR* in line 5 to be *CLEAR 1200,16344:GOSUB*.

If you have 32K, change line 5 to read *CLEAR 2000,32344:GOSUB*...Also change line 20 to read *FOR X=32345 TO 32383:READ*...and change the number 16345 in line 11032 to 32345. This will get you all kinds of memory for those changes you'll want to make.

If you have disk, you will have to have 32K to use this program (unless you unplug your disk controller). Make the changes listed above for 32K machines, and in addition make the following changes in several lines between 1000 and 2000. Every time you find a *CLOSE #-1*, *OPEN #-1*, *PRINT #-1*, or *INPUT #-1*, delete the minus sign in front of the one. Also, you will want to change the *PRINT* in line 1030 to something more appropriate such as "MAKE SURE THE PROPER DISK IS IN DRIVE 1, AND THEN HIT ANY KEY TO GO ON."

Now, on to using the program. This program will create and update character records for fantasy games. The operation will be fairly obvious when you run it, but a couple of notes are in order. It allows you to enter up to 60 spells and non-magical possessions, and up to 20 magic items. It sorts the magic spells by level, and it allows you to make changes or deletions easily before saving a character record to tape or disk, or printing it on the screen or printer.

It does not store thieving ability scores since you don't enter them. It computes them when you select "8" on the main menu, so if you print out the information before selecting number 8, all thief scores will still be 0. Just make sure that you go to number 8 before printing out the character information.

This program *POKEs* a short machine language routine into memory. All of the *DATA* for this routine is in line 12050. This little routine puts a nice border around the screen whenever you call it, and it does it instantly! The border can be changed by poking a value other than 169 into memory location 346. The program does this *POKE* in line 20, so just edit that line to get a different border design. Values above 128 are best, but values about 255 will result in an error message. This routine is 37 bytes long and is in position independent code, so if you use it in another program you can put it wherever you want it.

# YOUR COLOR COMPUTER JUST GOT WHEELS!

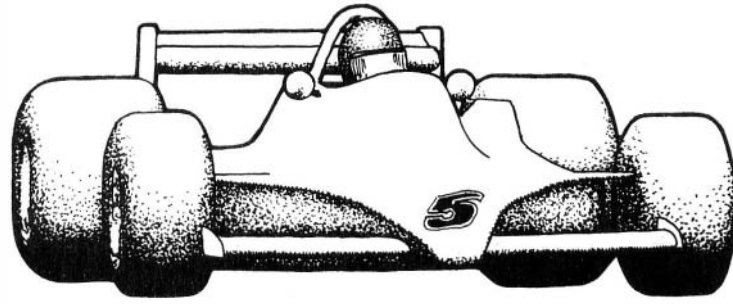

## REVOLUTION!

You accelerate hard down a long straightaway, braking heavily at the end for a hard corner. You slice smoothly through the esses, and then boldly keep the power on for a fast sweeper. The Ferrari drifts dangerously near the edge, but you make a tiny correction in the steering, and you are through.

The finish line flashes by, and suddenly you are in the pits. The car falls silent. You see your lap times being held up. Your final lap was a new lap record! At last, you permit yourself a small smile.

You have mastered this powerful car on a difficult track, driving with the assurance and precision that comes only from long hours of practice.

You are driving an *authentic* race car. You are playing *Revolution*!

### FANTASTIC ACTION

*Revolution* uses high resolution, machine language graphics for action that is smooth and fast. The emphasis is on authenticity in the control and motion of your car. As in driving a real race car, accuracy and precision in your driving are what counts. Frills and non-essentials have been left out.

### PURE COMPETITION

Like a real race driver in practice and qualifying sessions, you compete against the clock and against the existing lap record for that track. *Revolution* records the lap records and the name of the person who set the record, so you always know who reigns supreme on your favorite track!

### DESIGNED WITH YOU IN MIND

*Revolution* is menu-driven, and self explanatory. Information screens tell you what you need to know. When you're ready to play, a menu of the names of all your tracks is displayed, along with the lap record for each track and the name of the person who set that lap record. You select a track with a single keystroke, and *Revolution* takes you there.

### A NEW CONCEPT

*Revolution* is a unique game, because it allows you to create the most important part of any race game: the track itself.

The first time you run *Revolution*, you will be able to choose from several tracks and cars which are included with the game.

But, with *Revolution*, this is only the beginning! You can create as many tracks as you like. You can make each new track as difficult or as easy as you wish. You can make easy ones to begin with, and tougher ones as you become more skilled. You may find creating tracks to be almost as much fun as driving on them!

You can save your favorite tracks to run on again whenever you wish. *Revolution* will automatically add these new tracks to the menu. And you can exchange your favorite tracks with other *Revolution* owners.

Be careful, though, about letting your friends play this game. They may not want to let you have your computer back!

### THE EARLY REVOLUTION

A prototype version of *Revolution* was published in the September, 1982 issue of *Rainbow* magazine, under the name *The Track*. The response to *The Track* has been terrific.

*Revolution* has all the features that have made *The Track* a favorite, and *Revolution's* fast, high-resolution machine language graphics are dramatically improved over the prototype's.

### REVOLUTION NOW!

The original *Revolution* for the TRS-80™ Color Computer requires 32K and one disk drive. A new cassette version has action just like the disk version, and similar track-saving features excluding a menu of available tracks. The cassette version will run on a 16K Color Computer or TDP-100. You can upgrade to the disk version later, too, for a nominal fee.

<b>REVOLUTION</b>		
For 32K Disk . . . . .	\$24.95	Requires Joysticks
For 16K Cassette . . .	\$21.95	& Extended BASIC

Connecticut residents add 7½% sales tax.  
TRS-80 is a trademark of Tandy Corporation.



Inter  Action



113 Ward Street • Dept. R • New Haven, CT 06519 • (203) 562-5748

The print routine located at lines 2000 to 3000 takes advantage of a feature of the Color Computer which isn't mentioned anywhere I have seen. All of the accessories are addressed by the computer by referring to their device number. The disk drive is device number 1, the cassette is number -1, and the printer is number -2. Well, it happens that the television screen is device number 0, so you can print on the screen by doing a PRINT # 0, just as you would print on a printer by doing a PRINT # -2. You can also use a variable as the argument, as in PRINT # DV, and the output will go to the screen or printer depending on the value of the variable. By using this, the program will print on either the screen or printer and yet needs only one print routine. It just asks where you want it printed and sets the variable accordingly.

In the print routine I didn't use any control codes to make the print-out fancy. This was on purpose. (Really!) The control codes vary from machine to machine, and if your printer was a different brand from mine they wouldn't work, so if you want to get fancy on your own, have at it!

There is a two line section at 7300 and 7310 that sorts the magic spells by spell level. This routine is a very simple and short example of a bubble sort (a slow kind of sort, but easy to do) that would be practical for a list up to 100 or so entries long. The same general form could sort most anything.

I hope you will have as much fun using this program as I did writing it. It stores the files under the character name, so you should be able to put more than 50 files on a disk. If you have more than one on a tape, it will search the tape until it finds the correct one. I guess that wraps up this project, so we'll see what next month brings. If you have any suggestions write to me in care of Prickly-Pear Software, 9822 E. Stella Road, Tucson, AZ 85730.

(Mr. Nolan, an experienced Dungeonmaster in a popular fantasy role playing game on a weekly basis, is the president of Prickly-Pear Software.)



1600	0691
2260	0D39
4050	1403
6450	1B68
8340	2441
END	2BD2

The Listing:

```



1  '***COPYRIGHT 1983***
2  '***PRICKLY-PEAR SOFTWARE***
3  '***ALL RIGHTS RESERVED***
5  CLEAR999,16344:GOSUB11030
20  FORX=16345TO16383:READXX:POKE
X,XX:NEXTX:POKE346,169
100  CLS:XJ=USR0(XJ):PRINT@46,"ME
NU";:PRINT@98,"1. LOAD OR SAVE I
NFORMATION";:PRINT@130,"2. PRINT
OUT INFORMATION";:PRINT@162,"3.
START A NEW CHARACTER";:PRINT@1
94,"4. UPDATE BASIC INFORMATION"
;:PRINT@226,"5. NON-MAGICAL POSS
SESSIONS";
110  PRINT@258,"6. MAGICAL POSSES
SIONS";:PRINT@290,"7. SPELL BOOK
";:PRINT@322,"8. THIEF ABILITIES
";:PRINT@354,"9. SAVING THROWS";
:PRINT@386,"0. COMBAT INFORMATIO
N";:PRINT@453,"KEY YOUR CHOICE (
1-0)";:K$=INKEY$
120  K$=INKEY$:IFK$<>"0"ANDVAL(K$
)<1THEN120ELSEK$=VAL(K$):GOSUB110
20:IFK$=0THENK$=10
130  ONK GOTO1000,2000,3000,4000,
5000,6000,7000,8000,9000,10000
999  '***SAVE INFORMATION***
1000  CLS:PRINT" DO YOU WANT TO L
OAD OR SAVE A CHARACTER (L/S)?
":K$=INKEY$
1010  K$=INKEY$:IFK$<>"L"ANDK$<>"
S"THEN1010ELSEGOSUB11020:IFK$="L
"THEN1500
1020  INPUT"CHARACTER NAME (8 OR
FEWER LETTERS PLEASE)";CN$
1030  PRINT"PRESS PLAY AND RECORD
ON THE TAPE RECORDER, AND TH
EN HIT ANY KEY TO SAVE THE CHARA
CTER":K$=INKEY$:GOSUB11000
1040  OPEN"0",#-1,CN$
1050  FORX=0TO18:PRINT#-1,B$(X):N
EXTX
1060  FORX=0TO60:PRINT#-1,NP$(X):
NEXTX:PRINT#-1,NC
1070  FORX=0TO20:PRINT#-1,MP$(X,0
):PRINT#-1,MP$(X,1):NEXTX:PRINT#
-1,MC

```

**PREMIUM SOFTWARE  
FOR THE COLOR COMPUTER**

SISI (16K EXT. BASIC)	\$9.95
Sisi the fortune telling computer uses data that you input to determine a character reading for you.	
COLORHYTHM (16K EXT. BASIC)	\$9.95
Plots your biorhythm in hi-res graphics for 15 days.	
PRESCHOOL PAK (16K EXT. BASIC)	\$8.95
Two preschooler learning drills. Contains ALPHABET & COUNTER. Makes use of hi-res graphics and sound. The kids think it's a game!	
MONEY MINDER II (16K)	\$14.95
A cassette based personal finance program. Up to 56 user definable budget categories. Printout capability. Menu driven—easy to use.	
DISK MONEY MINDER (32K plus disk)	\$19.95
Similar to MONEY MINDER II but for use with disk. Easier and faster to use.	

P. O. BOX 1573  
SALT LAKE CITY, UTAH 84110

# NOVA-PINBALL

AN EXCITING NEW PINBALL SIMULATION FOR THE  
COLOR COMPUTER! WITH ALL THE ACTION THAT'S  
MADE IT AN ALL TIME FAVORITE!

\$20



# NOVA

**HIRES  
COLOR**

### FEATURES.

- Arcade Action Graphics and Sound
- 4 Players
- Live Action Flippers
- Action Bumpers and Thumpers
- Double and Triple Bonus Scores
- Extra Bonus Ball
- Ball Kicker



**CYBORG  
WARS**

LIKE THE ARCADE!  
ROBOTS ARE INVADING EARTH IN  
WAVE AFTER ADVANCING WAVE!  
Your mission is to destroy all robots and save the  
surviving humans. Watch for the missile firing BRAINS  
and the fatal touch of the HULKS!

ALL  
PROGRAMS  
MACHINE  
LANGUAGE  
REQUIRE  
16k

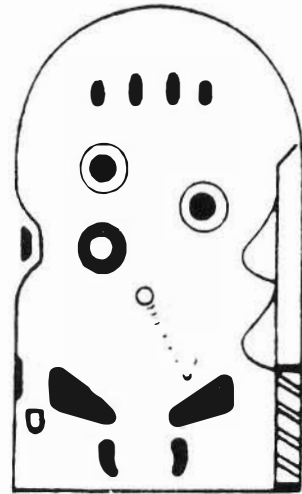

**PAC-MAC**

Great PAC-MAN action!

\$15

**BUG-ZAP**

Shoot bugs in formation, before they swoop down  
to attack you!

\$9

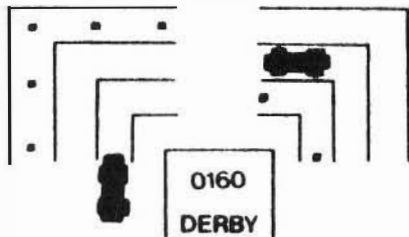

**DERBY**

Race around the track with a computer controlled  
car in pursuit Like the arcade, DODGE-EM! \$14

**BUMBLEBEE SOFTWARE**

Color Computer Machine Language Programs  
P.O. Box 25427  
Chicago, IL 60625

# ARCADE ACTION!

**HOPPY  
NEW!**



GUIDE HOPPY SAFELY HOME TO HIS  
DOCK TRAVEL ACROSS A HIGHWAY AND  
HOP ON LOGS & TURTLES TO GET THERE!  
LIKE THE ARCADE!

\$18

DEALER, AUTHOR INQUIRIES INVITED



```

1080 FORX=0TO60:PRINT#-1,SB$(X,0)
):PRINT#-1,SB$(X,1):NEXTX:PRINT#
-1,SC
1090 FORX=1TO5:PRINT#-1,ST(X):NE
XTX
1100 FORX=0TO20:PRINT#-1,CI$(X):
NEXTX
1200 CLOSE#-1:GOTO100
1500 CLS:PRINT"LOADING A CHARACT
ER WILL ERASE THE CURRENT MEMOR
Y. ARE YOU sure YOU WANT TO
DO THIS (Y/N)?:K$=INKEY$:GOSUB1
1060:IFK$="N"THEN100
1510 CLEAR:GOSUB11030:CLS:INPUT"
NAME OF THE CHARACTER YOU WANT
TO LOAD";CN$:GOSUB11020
1520 OPEN"I",#-1,CN$
1530 FORX=0TO18:INPUT#-1,B$(X):N
EXTX
1540 FORX=0TO60:INPUT#-1,NP$(X):
NEXTX:INPUT#-1,NC
1550 FORX=0TO20:INPUT#-1,MP$(X,0)
):INPUT#-1,MP$(X,1):NEXTX:INPUT#
-1,MC
1560 FORX=0TO60:INPUT#-1,SB$(X,0)
):INPUT#-1,SB$(X,1):NEXTX:INPUT#
-1,SC
1570 FORX=1TO5:INPUT#-1,ST(X):NE
XTX
1580 FORX=0TO20:INPUT#-1,CI$(X):
NEXTX
1600 CLOSE#-1:GOTO100
1999 '***PRINT INFORMATION***
2000 CLS:PRINT"DO YOU WANT THE I
NFORMATION PRINTED ON THE SC
REEN OR ON THE PRINTER? (S/P)":K
$=INKEY$
2010 K$=INKEY$:IFK$<>"S"ANDK$<>"
P"THEN2010ELSEGOSUB11020:IFK$="S
"THENDV=0ELSEDV=-2
2020 CLS:IFDV=-2THENPRINT"MAKE S
URE THE PRINTER IS ON LINEAND TH
EN HIT ANY KEY TO START.":K$=INK
EY$:GOSUB11000
2030 PRINT#DV,C$(7);" = ";B$(7):
FORX=0TO6:PRINT#DV,C$(X);" = ";B
$(X):NEXTX:IFDV=0THENGOSUB11050
2040 FORX=8TO18:PRINT#DV,C$(X);"
 = ";B$(X):NEXTX:IFDV=0THENGOSUB
11050
2050 ZX=0:CLS:PRINT#DV,"NON-MAGI
CAL POSSESSIONS":FORX=0TO60:IFNP
$(X)=""THEN2070
2060 PRINT#DV,NP$(X):ZX=ZX+1:IFZ
X>13ANDDV=0THENGOSUB11050
2070 NEXTX:IFDV=0THENPRINT"HIT A
NY KEY":K$=INKEY$:GOSUB11000
2080 ZX=0:CLS:PRINT#DV,"MAGIC IT
EMS CHARGES":FORX=0TO2
0:IFMP$(X,1)=""THEN2100

```

```

2090 PRINT#DV,MP$(X,0);TAB(27);M
P$(X,1):ZX=ZX+1:IFZX>13ANDDV=0TH
ENGOSUB11050
2100 NEXTX:IFDV=0THENPRINT"HIT A
NY KEY":K$=INKEY$:GOSUB11000
2110 ZX=0:CLS:PRINT#DV,"SPELL BO
OK":FORX=0TO60:IFSB$(X,1)=""THEN
2130
2120 PRINT#DV,SB$(X,0);TAB(4);SB
$(X,1):ZX=ZX+1:IFZX>13ANDDV=0THE
NGOSUB11050
2130 NEXTX:IFDV=0THENPRINT"HIT A
NY KEY":K$=INKEY$:GOSUB11000
2140 IFB$(17)=""ORB$(17)=""THEN
2200
2150 CLS:PRINT#DV,"PICK POCKETS
---- ";PP:PRINT#DV,"OPEN LOCKS -
----- ";OL:PRINT#DV,"FIND TRAPS
----- ";FT
2160 PRINT#DV,"MOVE SILENTLY ---
";MS:PRINT#DV,"HIDE IN SHADOWS
- ";HS:PRINT#DV,"HEAR NOISE ----
-- ";HN:PRINT#DV,"CLIMB WALLS --
--- ";CW:PRINT#DV,"READ LANGUAGE
S -- ";RL
2170 IFDV=0THENPRINT"HIT ANY KEY
":K$=INKEY$:GOSUB11000
2200 CLS:PRINT#DV,"SAVING THROWS
":PRINT#DV,"DEATH, POISON, ETC.
=";ST(1):PRINT#DV,"PETRIFICATION
OR POLY. =";ST(2):PRINT#DV,"ROD
S AND WANDS =";ST(3):PRINT#DV,"B
REATH WEAPONS =";ST(4):PRINT#DV,
"SPELLS =";ST(5)
2210 IFDV=0THENPRINT"HIT ANY KEY
":K$=INKEY$:GOSUB11000
2220 CLS:PRINT#DV,"ARMOR CLASS =
";CI$(0):PRINT#DV,"TO HIT ADJ.
 = ";CI$(1):PRINT#DV,"DAMAGE ADJ.
 = ";CI$(2)
2230 IFDV=0THENPRINT"HIT ANY KEY
":K$=INKEY$:GOSUB11000
2240 CLS:PRINT#DV,"WEAPONS OF PR
OFICIENCY":ZX=0:FORX=3TO20:IFCI$
(X)=""THEN2260
2250 PRINT#DV,CI$(X):ZX=ZX+1:IFZ
X>13ANDDV=0THENGOSUB11050
2260 NEXTX:PRINT"HIT ANY KEY":K$
=INKEY$:GOSUB11000:GOTO100
2999 '***START CHARACTER***
3000 CLS4:PRINT@128,"STARTING A
NEW CHARACTER WILL CLEAR INFOR
MATION CURRENTLY IN MEMORY!!!
ARE YOU sure YOU WANTTO DO THIS
(Y/N)???:K$=INKEY$
3010 K$=INKEY$:IFK$<>"Y"ANDK$<>"
N"THEN3010ELSEGOSUB11020:IFK$="N
"THEN100
3015 CLEAR:GOSUB11030
3020 CLS:INPUT" CHARACTER NAME";

```

The Programmer's Guild Presents . . .

# PAC — DROIDS™

BY  
*Charles Forsythe*

## THE ULTIMATE IN PAC-ACTION

ONLY \$19<sup>95</sup>

UP TO FOUR PLAYERS!!

*Unlike Any Other "PAC" Game You've Ever Seen!!  
Hot Machine Language Multi-Color  
High-Res Graphics For All 16K  
TRS-80 Color Computers*

**MORE SOUND — MORE ACTION  
MORE FEATURES THAN ANY  
"PAC" GAME IN EXISTENCE!!**

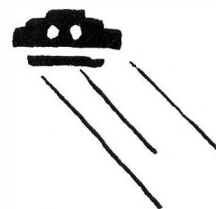

Try PAC-DROIDS™ for the Outer Limit in pure,  
explosive arcade action!!

SEND \$19.95 CHECK/MONEY ORDER or VISA/MC NUMBER  
TO

**THE PROGRAMMER'S GUILD  
P.O. BOX 66  
PETERBOROUGH, NH 03458  
—or Call (603) 924-6065 for COD—**



*AND GET "FREE" SHIPPING ANYWHERE ON THE PLANET  
EARTH OR HER COLONIES*

```

B$(7):GOSUB11020:PRINT:INPUT" ST
RENGTH";B$(0):GOSUB11020:INPUT"
EX. STRENGTH %";B$(1):GOSUB11020
:INPUT" INTELLIGENCE";B$(2):GOSU
B11020:INPUT" WISDOM";B$(3):GOSU
B11020:INPUT" DEXTERITY";B$(4):G
OSUB11020
3030 INPUT" CONSTITUTION";B$(5):
GOSUB11020:INPUT" CHARISMA";B$(6
):GOSUB11020
3040 CLS:PRINT" ";B$(7):PRINT:PR
INT" CLASS OR CLASSES SEPARATED
BY A SLASH (/)":INPUT" ";B$(8)
:GOSUB11020:INPUT" ALIGNMENT";B$
(9):GOSUB11020
3050 CLS:PRINT@68,"INDICATE RACE
";:PRINT@134,"1. DWARF";:PRINT@1
66,"2. ELF";:PRINT@198,"3. GNOME
";:PRINT@230,"4. HALF-ELF";
3060 PRINT@262,"5. HALFLING";:PR
INT@294,"6. HALF-ORC";:PRINT@326
,"7. HUMAN";:K$=INKEY$
3070 K$=INKEY$:K=VAL(K$):IFK<1OR
K>7THEN3070ELSEGOSUB11020:B$(18)
=K$
3080 ONK GOTO3090,3100,3110,3120
,3130,3140,3150
3090 B$(10)="DWARF":GOTO3160
3100 B$(10)="ELF":GOTO3160

```

```

3110 B$(10)="GNOME":GOTO3160
3120 B$(10)="HALF-ELF":GOTO3160
3130 B$(10)="HALFLING":GOTO3160
3140 B$(10)="HALF-ORC":GOTO3160
3150 B$(10)="HUMAN"
3160 CLS:PRINT" ";B$(7):PRINT" "
;B$(8):PRINT:PRINT" LEVEL(S) (SE
PARATE WITH /)":INPUT" ";B$(16):
GOSUB11020:PRINT:PRINT" THIEVING
SKILLS LEVEL":INPUT" ";B$(17):G
OSUB11020:IFVAL(B$(17))>17THENB$
(17)="17"
3170 CLS:PRINT" ";B$(7):PRINT:IN
PUT" AGE";B$(11):GOSUB11020:PRIN
T:INPUT" SEX";B$(14):GOSUB11020:
PRINT:INPUT" HEIGHT";B$(12):GOSU
B11020:PRINT:INPUT" WEIGHT";B$(1
3):GOSUB11020:PRINT:INPUT" HIT P
OINTS";B$(15):GOSUB11020:GOTO100
3999 '***UPDATE INFORMATION***
4000 CLS:XJ=USR0(XJ):FOR X=0 TO
18
4010 PRINT@34,"IS THIS CORRECT?
(Y/N)";
4020 PRINT@98,C$(X);" = ";B$(X);
:K$=INKEY$
4030 K$=INKEY$:IFK$<>"Y"ANDK$<>"
N"THEN4030ELSEGOSUB11020:IFK$="N
"THEN4045
4040 CLS:XJ=USR0(XJ):NEXT X:GOTO
100
4045 IFX=18THENPRINT@353,"1=DWAR
F, 2=ELF, 3=GNOME, 4=HALF
-ELF, 5=HALFLING, 6=HALF
-ORC, 7=HUMAN"
4050 PRINT@162,"ENTER THE NEW ";
C$(X);:PRINT@194,"";:INPUTB$(X):
GOSUB11020:GOTO4040
4999 '***NON-MAGICAL ITEMS***
5000 CLS:XJ=USR0(XJ):PRINT@98,"1
. INVENTORY";:PRINT@162,"2. ADD
ITEMS";:PRINT@226,"3. DELETE ITE
MS";:PRINT@290,"4. RETURN";:PRIN
T@420,"KEY YOUR CHOICE";:K$=INKE
Y$
5010 K$=INKEY$:K=VAL(K$):IFK<1OR
K>4THEN5010ELSEGOSUB11020
5020 ONK GOTO5100,5200,5300,100
5100 ZX=0:CLS:PRINT@10,"INVENTOR
Y":FORX=0TO60
5110 IFNP$(X)=""THEN5150
5120 PRINTNP$(X):ZX=ZX+1:IFZX>13
THENGOSUB11050
5130 NEXTX
5150 PRINT"HIT ANY KEY":K$=INKEY
$:GOSUB11000:GOTO5000
5200 CLS:PRINT"ENTER AN ITEM (Z
TO QUIT)":INPUT" ";K$:GOSUB1102
0:IFK$="ZZ"THEN5000
5205 IFNC>60THEN5230

```

**Chattanooga Choo Choo Software**

*Your One Stop Station  
For Computer Programs*



Track 29

**FREE SOFTWARE!**

Get your name on our mailing list and our CoCo could choose you to receive \$100.00 Credit toward software from our line.

Another name will be chosen to receive a one-year subscription to the **Rainbow**.

Winners will be notified in May and announced in June **Rainbow**.

**DEADLINE APRIL 30, 1983**

**COMING!**

**ZAXXON (32K) & MOON SHUTTLE (16K)**  
Should be available middle of March, be sure and check with us then

We now have ...  
\*Donkey King 32K \$24.95 and Master Control II \$22.95  
Also ... \*Flight Simulator E/B ~~\$24.95~~ \$22.45

\*Also available on disk (32K) at extra charge  
All programs 16K on cassette unless otherwise stated  
Send for our free complete catalog and descriptions!  
WE pay postage, YOU save money! (in the U.S. and Canada)  
TN residents add 6.25% sales tax, C.O.D. orders add \$1.00



(615) 875-8656  
P.O. Box 15892  
Chattanooga, Tn 37415



## THE STEREO COMPOSER

NEW  
PRODUCT!

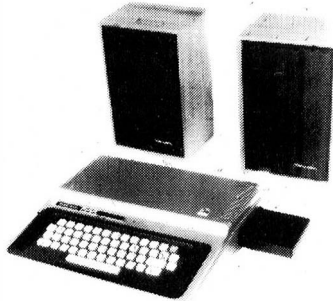

The **STEREO COMPOSER** music synthesizer was developed for the true music lover. All the features available for the **COMPOSER** described below are also available for the **STEREO COMPOSER**. However, instead of using the single 6 bit digital to analog converter built into the computer and the speaker built into your TV, the **STEREO COMPOSER** uses two 8 bit digital to analog converters which drive two audio power amplifiers. These amplifiers supply enough audio power to easily drive your own external speakers. If you like, the output may be connected to your home stereo system to further increase fidelity. Connection is provided by two phono connectors. If the music is too loud, two built-in volume controls are provided to allow you to control the volume of each of the channels separately. The advantage of being able to use external high quality speakers is obvious. The use of higher quality digital to analog converters serves to further increase music fidelity.

The **STEREO COMPOSER** produces music in stereo. Of the 4 voices produced, 2 are directed to each channel. This ability alone increases the realism of the music. You can even move the voices between speakers as the music plays.

The **STEREO COMPOSER** comes assembled, tested, burned in, with all the software and hardware to allow you to immediately start enjoying your music. A complete manual and examples are provided to give you everything you need to know.

The **STEREO COMPOSER** is completely memory decoded so it does not conflict with the Radio Shack disk controller. In this way, disk owners with an expansion interface such as the BT-1000 by Basic Technology can produce music from disk with the **STEREO COMPOSER** in one slot and the disk controller in another. In fact, you can even have **THE VOICE** in another slot without any fears that there will be memory conflicts.

Requires Extended BASIC and Minimum of 16K  
Specify Cassette or Disk

STEREO COMPOSER (Hardware and Software) ..... \$119.95



## THE COMPOSER



The **COMPOSER** is a 4 voice music compiler which easily allows one to develop high quality music. Each voice is programmed separately. In addition, each voice uses its own wave shape table which means a unique sound for each of the 4 voices.

The **COMPOSER** features a 7 octave range. It supports dotted and double dotted notes as well as eighth, quarter, and standard triplet notes. Sixteenth and thirty second notes are also supported.

The **COMPOSER** allows the music to be played at any tempo and in any key. And believe it or not, the tempo and key can be modified as the music plays. This gives the user tremendous versatility in developing music. Key modification also allows the user to move the music up or down one or more octaves.

The **COMPOSER** displays a constantly changing random kaleidoscope pattern as the music plays. In addition, the number of the note being played is displayed which aids one in finding sour notes during music development. Both of these displays can be disabled to allow any screen to be displayed while the music is playing. In this way, one can show the words to a song or display a picture as the music plays.

The **COMPOSER** develops a machine language position independent subroutine that can be Saved, Loaded, and Executed independent of all other software. This means that you can share your music with friends. In fact, you can write your own BASIC programs that call and play the music. Software vendors may include the music in their own product.

The **COMPOSER** is menu driven making it extremely easy and friendly to use and operate. A thick operating manual is also provided. Many examples are given to aid the user in getting started. All you need is provided, no additional hardware is necessary. Don't let the price fool you, the **COMPOSER** has got to be heard to be appreciated.

Requires Extended BASIC and Minimum of 16K

CASSETTE VERSION ..... \$24.95  
DISK VERSION (32K) ..... \$29.95

## THE VOICE

NEW  
PRODUCT!



**SPEECH SYSTEMS** got its start providing high quality speech synthesizers for SS-50 bus computers. We are now proud to announce the same high quality product for the Color Computer and TDP-100.

**THE VOICE** should not be mistaken with software speech synthesizers which require the computer to do all the work in producing speech.

**THE VOICE** uses a special large scale integrated circuit, the SC-01 by VOTRAX, to reproduce any one of 64 phonemes at 4 inflections. Phonemes are basic units of speech which allow one to reproduce any word in English as well as many other languages.

**THE VOICE** has two outputs. Speech may be heard through the user's TV speaker, or the built-in audio power amplifier may be connected to your own external speaker. A phono connector is provided for this purpose and if the volume is too high, a built-in volume control may be used to adjust it to the proper level.

**THE VOICE** comes assembled, tested, burned in, with all the necessary hardware and software. A complete manual with many examples are provided to get you started in developing your own BASIC or machine language programs to use speech.

**THE VOICE** is completely memory decoded so it does not conflict with the Radio Shack disk controller. In this way, disk owners with an expansion interface such as the BT-1000 by Basic Technology can produce speech from disk with **THE VOICE** in one slot and the disk controller in another. In fact, you can even have the **STEREO COMPOSER** in another slot without any fears that there will be memory conflicts.

We are trying to develop a library of software for **THE VOICE**. Toward this end, we will be offering substantial royalties to software authors for their work.

Requires Extended BASIC and Minimum of 16K  
Specify Cassette or Disk

THE VOICE (Hardware and Software) ..... \$179.95

## HOW TO ORDER

We accept CASH, CHECK, COD, VISA, and MASTER CARD orders.

Shipping and handling for all products in the continental US and Canada ..... \$2.00

Shipping and handling for all products outside the continental US and Canada ..... \$5.00

COD charge (requires cash, certified check, or money order) ..... \$2.00

Illinois residents purchasing the **STEREO COMPOSER** or **THE VOICE** please add 5 1/4% sales tax.

Dealer Inquiries Invited

SPECIALISTS IN SYNTHESIZERS  
FOR THE COLOR COMPUTER AND TDP-100.

# Speech Systems

38W255 DEERPATH ROAD  
BATAVIA, ILLINOIS 60510

(312) 879-6880

CALL ANY DAY, ANY TIME TO ORDER. YOU MAY ALSO ORDER BY MAIL.





# DONKEY KING

(C) 1982



32K Machine Language

**\$26.95 TAPE**

**\$29.95 DISK**

## ARCADE ACTION

This game contains all 4 screens like the popular arcade game. The actual screen photos shown are only 2 of the four contained in this program.

Actual T.V. Screen Photos.

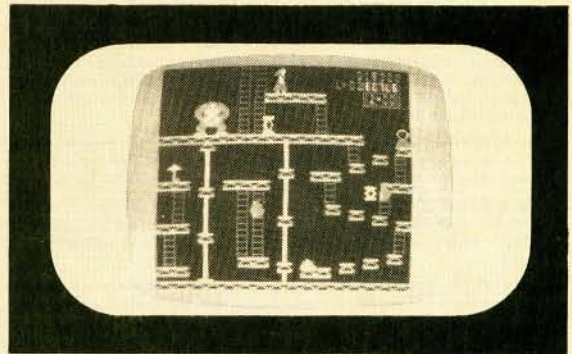

How high can you climb?  
Plays like the popular arcade game!

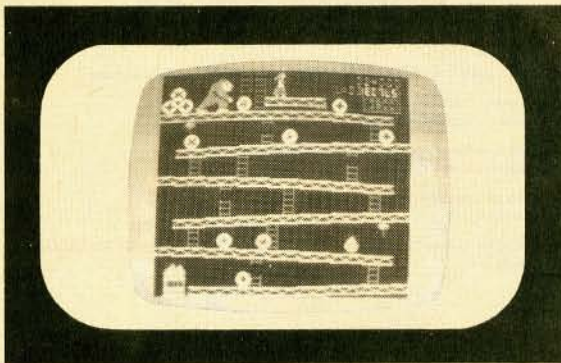

**Four** full graphic screens. Exciting sound and realistic graphics. Never before has the color computer seen a game like this. Early reviews say simply outstanding.

**RAINBOW:** Donkey King is the king of the donkey games and a fantastic rendition of a popular arcade offering.



**COLOR COMPUTER:** Consider the excellence of Donkey King as an example of what the Color Computer is capable of.

# TOM MIX SOFTWARE

For The Color Computer and The TDP-100

3424 College, N.E., Grand Rapids, MI 49505 • (616) 364-4791



Add \$1.00 Postage & Handling  
Michigan Residents Add 4% Sales Tax

- Top Royalties Paid
- Looking For New Software



```

5210 NP$(NC)=K$:NC=NC+1:IFNC>60T
HEN5230
5220 GOT05200
5230 PRINT"FILE FULL":FORX=1T020
00:NEXTX:GOTO5000
5300 CLS:PRINT"WHAT DO YOU WANT
TO DELETE?":INPUTK$:GOSUB11020
5310 FORX=0TONC:IFK$=NP$(X)THEN5
330
5320 NEXTX:PRINT"FILE NOT FOUND"
:FORX=1T02000:NEXTX:GOTO5000
5330 NP$(X)=""
5340 FORY=X TONC:NP$(Y)=NP$(Y+1)
:NEXTY
5350 FORX=0T061:IFNP$(X)=""THENN
C=X:GOTO5000
5360 NEXTX
5999 '***MAGICAL POSSESSIONS***
6000 CLS:XJ=USR0(XJ):PRINT@98,"1
. INVENTORY";:PRINT@162,"2. ADD
ITEMS";:PRINT@226,"3. DELETE ITE
MS";:PRINT@290,"4. CHANGE CHARGE
S";:PRINT@354,"5. RETURN";:PRINT
@420,"KEY YOUR CHOICE";:K$=INKEY
$
6010 K$=INKEY$:K=VAL(K$):IFK<10R
K>5THEN6010ELSEGOSUB11020
6020 ONK GOT06100,6200,6300,6400
,100
6100 ZX=0:CLS:PRINT@10,"INVENTOR
Y":FORX=0T020
6110 IFMP$(X,0)=""THEN6150
6120 PRINTMP$(X,0);TAB(27);MP$(X
,1):ZX=ZX+1:IFZX>13THENGOSUB1105
0
6130 NEXTX
6150 PRINT"HIT ANY KEY":K$=INKEY
$:GOSUB11000:GOTO6000
6200 CLS:PRINT"ENTER AN ITEM (ZZ
TO QUIT)":INPUT" ";K$:GOSUB1102
0:IFK$="ZZ"THEN6000
6205 IFMC>20THEN6230
6207 INPUT"ENTER THE CHARGES";MP
$(MC,1):GOSUB11020
6210 MP$(MC,0)=K$:MC=MC+1:IFMC>2
0THEN6230
6220 GOT06200
6230 PRINT"FILE FULL":FORX=1T020
00:NEXTX:GOTO6000
6300 CLS:PRINT"WHAT DO YOU WANT
TO DELETE?":INPUTK$:GOSUB11020
6310 FORX=0T0MC:IFK$=MP$(X,0)THE
N6330
6320 NEXTX:PRINT"FILE NOT FOUND"
:FORX=1T02000:NEXTX:GOTO6000
6330 MP$(X,0)="" :MP$(X,1)=""
6340 FORY=X T0MC:MP$(Y,1)=MP$(Y+
1,1):MP$(Y,0)=MP$(Y+1,0):NEXTY
6350 FORX=0T021:IFMP$(X,0)=""THE
NMC=X:GOTO6000

```

```

6360 NEXTX
6400 CLS:PRINT" ON WHICH ITEM DO
YOU WANT TO CHANGE THE CHARG
ES?":INPUT" ";K$
6410 FORX=0T021:IFMP$(X,0)=K$THE
N6450
6420 NEXTX
6430 PRINT" ITEM NOT FOUND":FORX
=1T02000:NEXTX:GOTO6000
6450 PRINT:PRINT" THE ITEM HAS "
;MP$(X,1);" CHARGES":PRINT" NOW.
INPUT THE CORRECT.":INPUT" NUM
BER";MP$(X,1):GOSUB11020:GOTO600
0
6999 '***MAGIC SPELLS***
7000 CLS:XJ=USR0(XJ):PRINT@98,"1
. ADD A SPELL";:PRINT@162,"2. DE
LETE A SPELL";:PRINT@226,"3. SOR
T THE SPELLS";:PRINT@290,"4. SPE
LL BOOK";:PRINT@354,"5. RETURN";
:PRINT@450,"KEY YOUR CHOICE";:K$
=INKEY$
7010 K$=INKEY$:K=VAL(K$):IFK<10R
K>5THEN7010ELSEGOSUB11020
7020 ONK GOT07100,7200,7300,7400
,100
7100 CLS:IFSC>60THEN7190
7105 PRINT" ENTER THE SPELL NAME
(ZZ TO QUIT)":INPUT" ";SB$(
SC,1):GOSUB11020:IFSB$(SC,1)=""ZZ
"THENSB$(SC,1)="" :GOTO7000
7110 PRINT:INPUT" WHAT LEVEL";SB
$(SC,0):GOSUB11020:SC=SC+1:IFSC>
60THEN7190
7120 GOT07100
7190 PRINT"FILE FULL":FORX=1T020
00:NEXTX:GOTO7000
7200 CLS:PRINT" SPELL TO DELETE"
:INPUT" ";K$:GOSUB11020
7210 FORX=0T0SC:IFK$=SB$(X,1)THE
N7240
7220 NEXTX:PRINT" FILE NOT FOUND"
:FORX=1T02000:NEXTX:GOTO7000
7240 SB$(X,0)="" :SB$(X,1)="" :FOR
XX=X T060:SB$(XX,0)=SB$(XX+1,0):
SB$(XX,1)=SB$(XX+1,1):NEXTXX
7250 FORX=0T060:IFSB$(X,1)=""THE
NSC=X:GOTO7000
7260 NEXTX
7300 CLS:PRINT" SORTING":FORX=0T
0SC-2:IFSB$(X,0)>SB$(X+1,0)THENK
$=SB$(X,0):SB$(X,0)=SB$(X+1,0):S
B$(X+1,0)=K$:K$=SB$(X,1):SB$(X,1
)=SB$(X+1,1):SB$(X+1,1)=K$:GOTO7
300
7310 NEXTX:GOTO7000
7400 ZX=0:CLS:PRINT@10,"SPELLBOO
K":FORX=0T060
7410 IFSB$(X,1)=""THEN7450
7420 PRINTSB$(X,0);TAB(4);SB$(X,

```



```

1):ZX=ZX+1:IFZX>13THENGOSUB11050
7430 NEXTX
7450 PRINT"HIT ANY KEY":K$=INKEY
$:GOSUB11000:GOTO7000
7999 '***THIEVING SKILLS***
8000 CLS
8020 L=VAL(B$(17)):IFL=0THEN100
8030 PP=DA(L,0):OL=DA(L,1):FT=DA
(L,2):MS=DA(L,3):HS=DA(L,4):HN=D
A(L,5):CW=DA(L,6):RL=DA(L,7)
8040 D=VAL(B$(4)):IFD>18THEND=18
8050 D=D-8:OND GOSUB8180,8190,82
00,8210,8220,8220,8220,8230,8240
,8250
8090 K=VAL(B$(18))
8100 ONK GOSUB8110,8120,8130,814
0,8150,8160,8170:GOTO8260
8110 OL=OL+10:FT=FT+15:CW=CW-10:
RL=RL-5:RETURN
8120 PP=PP+5:OL=OL-5:MS=MS+5:HS=
HS+10:HN=HN+5:RETURN
8130 OL=OL+5:FT=FT+10:MS=MS+5:HS
=HS+5:HN=HN+10:CW=CW-15:RETURN
8140 PP=PP+10:HS=HS+5:RETURN
8150 PP=PP+5:OL=OL+5:FT=FT+5:MS=
MS+10:HS=HS+15:HN=HN+5:CW=CW-15:
RL=RL-5:RETURN
8160 PP=PP-5:OL=OL+5:FT=FT+5:HN=
HN+5:CW=CW+5:RL=RL-10:RETURN
8170 RETURN

```

```

8180 PP=PP-15:OL=OL-10:FT=FT-10:
MS=MS-20:HS=HS-10:RETURN
8190 PP=PP-10:OL=OL-5:FT=FT-10:M
S=MS-15:HS=HS-5:RETURN
8200 PP=PP-5:FT=FT-5:MS=MS-10:RE
TURN
8210 MS=MS-5:RETURN
8220 RETURN
8230 OL=OL+5:RETURN
8240 PP=PP+5:OL=OL+10:MS=MS+5:HS
=HS+5:RETURN
8250 PP=PP+10:OL=OL+15:FT=FT+5:M
S=MS+10:HS=HS+10:RETURN
8260 PRINT@67,"PICK POCKETS ----
";PP
8270 PRINT@99,"OPEN LOCKS -----
";OL
8280 PRINT@131,"FIND TRAPS -----
- ";FT
8290 PRINT@163,"MOVE SILENTLY --
- ";MS
8300 PRINT@195,"HIDE IN SHADOWS
- ";HS
8310 PRINT@227,"HEAR NOISE -----
- ";HN
8320 PRINT@259,"CLIMB WALLS ----
- ";CW
8330 PRINT@291,"READ LANGUAGES -
- ";RL
8340 PRINT@355,"PRESS ANY KEY TO
GO ON";K$=INKEY$:GOSUB11000:GO
TO100
8999 '***SAVING THROWS***
9000 CLS:PRINT"ENTER THE SAVING
THROW AGAINST:":PRINT:INPUT"DEAT
H, POISON, PARALY.":ST(1):GOSUB1
1020
9010 PRINT:INPUT"PETRIFICATION O
R POLY.":ST(2):GOSUB11020:PRINT:
INPUT"RODS AND WANDS":ST(3):GOSU
B11020
9020 PRINT:INPUT"BREATH WEAPONS"
;ST(4):GOSUB11020:PRINT:INPUT"SP
ELLS":ST(5):GOSUB11020:GOTO100
9999 '***COMBAT INFORMATION***
10000 CLS:INPUT"ARMOR CLASS":CI
$(0):GOSUB11020:PRINT:INPUT"ADJ
. TO HIT":CI$(1):GOSUB11020:PRIN
T:INPUT"DAMAGE ADJ.":CI$(2):GOS
UB11020
10010 PRINT:PRINT"DO YOU WANT T
O ADD WEAPONS OF PROFICIENCY?
(Y/N)":K$=INKEY$
10020 GOSUB11060:IFK$="N"THEN100
10030 FORX=3TO20:IFCI$(X)<>"THE
N10060
10040 CLS:INPUT"ENTER THE WEAPO
N YOU WANT TO ADD. (OR ENTER
'ZZ' TO QUIT) ";CI$(X):GOSUB11

```



## COLOR-STICK

### 'HERE AT LAST'

Finally an interface for the TRS-80\* Color Computer to let you use the famous:

### 'ATARI\* JOYSTICK'

Just plug your Atari or Atari like (the Color-Stick enables the use of most joysticks made for the Atari) joystick into the Color-Stick interface and then plug the Color-Stick into an empty joystick port.

The Color-Stick can improve scores 50% and more while making some games more exciting and fun to play.

Color-Stick interface \$19.95 each OR  
Two for \$34.95. (less joysticks)  
Atari Joysticks \$9.95 each.

## Better Software Company

P.O. Box 2770  
Greenville, South Carolina 29602  
(803) 295-3648

Add \$2.00 per order shipping and handling. Bank cards welcomed (please include expiration date). Orders paid by cashiers check, money orders, bank cards and C.O.D. are shipped within 48 hours. Personal checks please allow 1-2 weeks. C.O.D. orders add \$1.50 extra. S.C. residents add 4% sales tax.

\*TRS-80 is a registered trademark of Tandy Corp. Atari is a registered trademark of Atari, Inc.



# ENDICOTT SOFTWARE

## JOYSTICKS

DEALER & CLUB INQUIRIES INVITED



**AFFORDABLE**

**ONLY  
\$19.95**

**TWO FOR  
\$37.95**

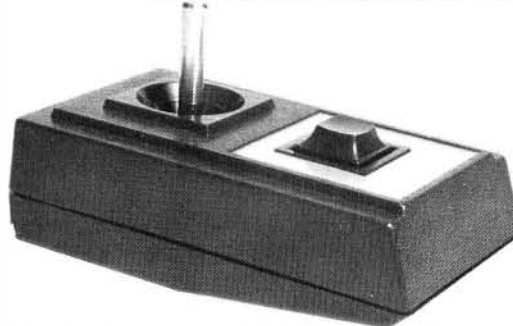

**ACCURATE**

**SMOOTH  
RESPONSE**

**BUILT TO  
LAST**

Tired of broken joysticks? We offer an affordable joystick based on proven components. Each unit is hand assembled and checked to ensure **reliability**. The handles and internal mechanism have proven to be extremely **rugged** and **reliable** under extensive use with arcade-type games. The pots function smoothly to provide excellent cursor/character control. Get your joystick programs working the way they **should!** Our joysticks are backed by a 90 day warranty on material and labor (physical abuse excluded).

### EXCELLENT PROGRAMS FROM LEADING SOFTWARE HOUSES

#### NEW DISCOUNT ON PRICKLY-PEAR SOFTWARE!

**20% OFF UNTIL APRIL 7**

* <b>VIKING</b> Go from peasant to King!	<del>\$19.95</del>	\$15.96	
* <b>GANGBUSTERS</b> Lead a life of crime and win!	<del>\$19.95</del>	\$15.96	
* <b>FANTASY GAMER'S PACKAGE</b> Generates dungeons, characters, and monsters and includes sample module.	<del>\$19.95</del>	\$15.96	
<b>PANDORA'S BOX</b> Includes: "pac" game, "defender-type" game, Divebomb, Blockade, slot machine, and Squares (similar to cube).	<del>\$24.95</del>	\$19.96	
* <b>PREREAD I, II, &amp; III</b> Prepare your preschooler to learn to read (three tapes).	<del>\$24.95</del>	\$19.96	
* <b>PHONICS I</b> 1 tutorial tape, 1 quiz tape. These begin the learning to read process.	<del>\$24.95</del>	\$19.96	
* <b>PHONICS II</b> 1 tutorial tape, 1 quiz tape. Advancement from PHONICS I	<del>\$24.95</del>	\$19.96	

#### TOM MIX SOFTWARE

* <b>KATERPILLAR ATTACK</b> Fast Action!	\$24.95	
* <b>SHIP WRECK</b> Great adventure!	\$14.95	
<b>WAR KINGS</b> Two player action.	\$19.95	
* <b>MOON LANDER</b> 2 games in 1	\$15.95	
* <b>CASINO</b> 3 Game Pack	\$12.95	
<b>TAPE DUPE</b> Copies any ML tape.	\$16.95	
<b>DISK TO TAPE</b> Dump disk to tape	\$19.95	
<b>TAPE TO DISK</b> Load any tape to disk	\$19.95	
* <b>SPELLING TEST</b> Provides a standard oral spelling test. Optional printer output.	\$19.95	

#### COGNITEC

<b>TELEWRITER</b> THE word processor for the CoCo	\$49.95	
---	---------	--

\* Requires 16K Ext. Basic minimum - others 16K Std. Basic minimum.

Call or write for free catalog.

SHIPPING: U.S.A., CANADA AND MEXICO

**WE PAY** postage on all software orders. Add \$2.00 for shipping joysticks (unless purchased with software - then we'll pay). Please add \$2.00 for C.O.D. orders (available in U.S.A. only). Allow 2 weeks for personal checks to clear.

SHIPPING: ALL OTHER COUNTRIES

Add \$2.00 for each software item. Add \$5.00 for each Joystick. Items will be shipped air mail.

ALL PAYMENTS MUST BE IN U.S. FUNDS.

**ENDICOTT SOFTWARE**

P.O. Box 12543, Huntsville, AL 35802

(205) 881-0506

PHONE OPEN 7 DAYS A WEEK!



#### MARK DATA PRODUCTS

**15% OFF UNTIL APRIL 7**

<b>HAYWIRE</b> Will drive you BERZERK!	<del>\$24.95</del>	\$21.20	
<b>BLACK SANCTUM</b> Challenging adventure!	<del>\$19.95</del>	\$16.95	
<b>ASTRO BLAST</b> Fight waves of alien attackers	<del>\$24.95</del>	\$21.20	
<b>CAVE HUNTER</b> Grab the treasure and outrun the creatures.	<del>\$24.95</del>	\$21.20	
<b>SPACE RAIDERS</b> Not just another Invaders game.	<del>\$24.95</del>	\$21.20	

#### COMPUTERWARE

<b>SPACE AMBUSH</b> Action like Galaxian.	\$24.95	
<b>EL DIABLERO</b> Outstanding adventure.	\$19.95	
<b>DOODLE BUG</b> Like Ladybug	\$24.95	
<b>RAIL RUNNER</b> Like Frogger.	\$21.95	
<b>PAC ATTACK</b> Great gobbler.	\$24.95	
<b>STORM</b> A real Tempest!	\$24.95	
<b>COLOR INVADERS</b> Like the original.	\$19.95	

#### COLORSOFT

* <b>MATH DERBY</b> Fun while learning!	\$13.95	
---	---------	--

#### ANTECO SOFTWARE

<b>INTERGALACTIC FORCE</b> Experience trench warfare in your X-Wing fighter.	\$24.95	
* <b>HOUSEHOLD EXPENSE MANAGER</b> Menu-driven with 30 household categories. Screen or printer output.	\$19.95	
* <b>STOCK ANALYZER AND TREND</b> Track your stocks. Disk compatible. Optional printer output.	\$21.95	

### ★ ★ 32 Korner ★ ★

(Requires 32K Ext. Basic)

<b>DONKEY KING</b> 4 Screens - Full action!	\$24.95	
<b>PROTECTORS</b> Excellent Defender type.	\$24.95	
<b>COLOR GOLF</b> Challenging! Uses full set of clubs.	\$16.95	
<b>PRICKLY-PEAR'S 32K FANTASY GAMER'S PACKAGE</b> Like 16K version, but much more!	<del>\$24.95</del> \$19.96	
<b>PETROCCI FREELANCE ASSOCIATES INSPECTOR CLUESEAU</b> You must find the murderer in this excellent graphic adaptation of Clue.	\$19.95	



```

020
10050 IFCI$(X)="ZZ"THENCI$(X)=""
:GOTO100
10060 NEXTX
10070 PRINT"NO MORE SPACE":FORX=
1TO2000:NEXTX:GOTO100
11000 REM***HIT A KEY TO GO ON**
*
11010 IFINKEY$=""THEN11010ELSEGO
SUB11020:RETURN
11019 '***KEY BEEP***
11020 PLAY"T255L25505CDEFGABAGFE
DC":RETURN
11029 '***DIMENSION ARRAYS***
11030 DIMDA(17,7),B$(18),C$(18),
NP$(62),ST(5),CI$(20),MP$(22,1),
SB$(62,1)
11032 DEFUSR0=16345
11035 RESTORE:FORX=1TO17:FORY=0T
07:READDA(X,Y):NEXTY,X
11038 FORX=0TO18:READC$(X):NEXTX
11040 RETURN
11049 '***LIST ROUTINE***
11050 PRINT"HIT ANY KEY FOR MORE
";:K$=INKEY$:GOSUB11000:ZX=0:CLS
:RETURN
11059 '***YES OR NO***
11060 K$=INKEY$:IFK$<>"Y"ANDK$<>
"N"THEN11060ELSEGOSUB11020:RETUR
N

```

```

12000 '***THIEVING DATA***
12010 DATA 30,25,20,15,10,10,85,
0,35,29,25,21,15,10,86,0,40,33,3
0,27,20,15,87,0,45,37,35,33,25,1
5,88,20,50,42,40,40,31,20,90,25,
55,47,45,47,37,20,92,30,60,52,50
,55,43,25,94,35
12020 DATA 65,57,55,62,49,25,96,
40,70,62,60,70,56,30,98,45,80,67
,65,78,63,30,99,50,90,72,70,86,7
0,35,99.1,55,100,77,75,94,77,35,
99.2,60,105,82,80,99,85,40,99.3,
65,110,87,85,99,93,40,99.4,70,11
5,92,90,99,99,50,99.5,75
12030 DATA 125,97,95,99,99,50,99
.6,80,125,99,99,99,99,55,99.7,80
12032 '***CHARACTERISTICS***
12034 DATA STRENGTH,EX.STR. %,IN
TELLIGENCE,WISDOM,DEXTERITY,CONS
TITUTION,CHARISMA,NAME,CLASS,ALI
GNMENT,RACE,AGE,HEIGHT,WEIGHT,SE
X,HIT POINTS,LEVELS,THIEVING LEV
EL,RACE #
12040 '***ML ROUTINE DATA***
12050 DATA 198,32,182,1,90,142,4
,0,167,128,140,4,31,38,249,142,5
,224,167,128,140,6,0,38,249,142,
4,32,167,132,167,31,58,140,6,0,3
8,246,57

```

## YOUR COLOR COMPUTER JUST EARNED A MATH DEGREE!

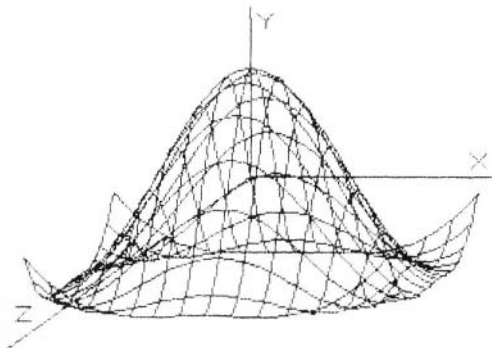

### MATHMENU

Developed by an engineer, *Mathmenu* is a powerful menu-driven system to turn your Color Computer into an intelligent, flexible tool for mathematics and engineering. *Mathmenu* takes the tedium out of math, leaving your full brain power to attack the "meat" of your problems. By rapidly manipulating matrices and vectors, performing integration and differentiation, solving quadratic equations, plotting user defined functions and much more, *Mathmenu* can help simplify the most complex problems. Whether you are a student or a professional, if you use math, you need *Mathmenu*.

#### FEATURING:

- 3D SURFACE PLOTTING — Plots a user defined equation on an X,Y,Z coordinate system in the High-Res graphics mode. Planes, surfaces of revolution, statistical surfaces, etc. can be easily plotted. Surfaces may be saved to disk or tape. We believe this is the only program of its kind commercially available for the Color Computer.

#### PLUS:

- Complete MATRIX Operations (up to 8 x 8)
- Complete VECTOR Operations
- Numerical Differentiation
- Numerical Integration
- Least Squares Curve Fitting
- Binomial Expansion
- Prime Number Expansion
- Main Menu with Single-key Selection and Return (Disk Only)
- 2D Function Plotting
- Rectangular to Polar Conversions
- Base Conversions
- Large Number Addition and Multiplication
- Reverse Polish Logic Calculator with Hexadecimal
- Quadratic Equation Roots

Complete documentation of all functions is included.

For 32K Disk ..... \$49.95  
 For 16K Cassette ..... \$44.95  
 Documentation only ..... \$2.00 (refundable with purchase)

Or write for free brochure.



Inter  Action

113 Ward Street • Dept. R • New Haven, CT 06519 • (203) 562-5748

# NOW THERE ARE TWO TOOLKITS FOR THE COLOR COMPUTER

The software development tools that let you put even more **power** into the already powerful Color Computer. They're full of tools, aids, bells and whistles useful to the BASIC or MACHINE LANGUAGE programmer, in friendly, easy-to-use software packages.

## BOTH TOOLKITS CONTAIN . . .

- **Light characters on dark background with Current Line Highlighting**; or normal characters
- **Full Screen Editor** with **Arrow Key** controlled cursor; **open up space/delete and close up space**
- Enabling selective **Line Renumber/copy/move/merge**; or normal Extended Basic line editor
- **Protect** the current BASIC program from being wiped out with a CLOAD, NEW etc.; or from being LISTed
- **Restore** a protected BASIC program/**Append** any number of BASIC programs together easily
- **Tone** on keypress or normal silent keys (Tone modifiable by use of Sound n,n Command)
- **Global Search** of command or text strings in BASIC programs with **wildcard** character and **next** "."
- **9 Screen Print Delays** with keyboard override (for slow, readable LISTings and DISK DIRectories)
- **Variable Name List/String-Byte** memory usage/Range of FREE MEM/Top of memory address display
- Fast Machine Code to BASIC DATA **converter** for storing machine code visibly in BASIC
- (C)SAVEM address/**Backup Tool** (Last file name, start, end and execute address)
- **Recovery of Lost BASIC** programs after NEW, BACKUP, DSKINI, etc.
- **Break Key Disable/Enable** (Pause keys still available)
- **Modified TRON** display (.LN replaces {LN})

## THE FULL TOOLKIT ALSO CONTAINS . . .

- Merge BASIC** with Machine Code routines so machine code is "invisible" and (C)SAVE/(C)LOADable
- 9 BASIC RUN delays** with keyboard override; **Single Step(s)** mode with current line number display
- Memory Examine/Modify** with HEX/ASCII/DEC/Double Decimal output and HEX/ASCII input
- Memory **Block Move** for relocating machine code programs, DATA blocks, etc.; or the Kit itself
- Ten User Defined Function Keys** accessible with @/number (BASIC Macros/Block storage)
- Automatic linefeed** for printers that don't/double space LISTings; or normal PRINT
- Delete all spaces** (not in PRINT strings, DATA or REMARK lines)
- ASCII/HEX memory **Dumps** to screen or printer
- Delete all REMarks** (either REM or ' type)
- Parallel **ECHO** of screen output to printer

## THESE FEATURES ARE FOUND ON BOTH VERSIONS . . .

- **Transparent** to the user, Install it and forget it until you need it
- BASIC runs up to one-third faster through the Toolkit (5-10% typical)
- **HELP** command lists all Kit commands and current Kit address
- Same program works with tape or disk and in 16 or 32K
- Entire system totally **removable** at any time
- **Compatible** with other utility programs
- Green/Orange text screen capability
- Easily **modifiable** command syntax

The Kits are relocatable programs that load any time without bothering your BASIC program or variables or top of memory address. All tools may be turned on or off at will, including the Kit itself.

The tools are available with simple three or four letter commands entered in the direct mode, with the entire instruction set viewable through the HELP command.

The Colorkit is 5K bytes for \$29.95  
Available on disk with handy BASIC Kit loader for additional \$5



The Microkit is 2.5K bytes for \$27.95  
Manual available separately for \$5

### THE GOOD LIFE

\$16.95

- The Classic Game of Life With:
- 64x64 color symmetrical display
- **3 Selectable birth and old age colors**
- **15 modifiable pre-programmed patterns**
- **Save/Load life screens to tape/disk**
- **Speeds from 8 gen/sec to 1 a second**
- **Joystick or arrow key input**
- **Written in user-modifiable BASIC**
- **With machine code LIFE processor**
- **Help screen command list**
- **Tape/Disk compatible**
- **Selectable color sets**
- **Y&X axis wraparound**



### THE DISK COMMANDER

\$19.95

- Disk File Utility with:
- **One key view/copy/load(m) of files**
- **Two key kill/rename of files**
- **Sort directory on name/extension**
- **Pack directory so new files put at end**
- **Directory keyword search of filename**
- **Print DIR with machine code address**
- **Recover killed files**

### DEER HUNT

\$15.95

- **Arcade shoot-em-up skill game**
- **Aim only for the deer**
- **Avoid hitting people, cars, train**
- **Will not cause tension headache**
- **BASIC/machine code hybrid**
- **Tape/Disk compatible**

**ARIZIN**  
**P. O. Box 8825**  
**Scottsdale, AZ 85252**

## Wormhole Is High-Energy Graphics Game

Now you can tour the depths of space through the miracle of *Wormhole*, a game combining natural curiosity with the color and imagination of the new technology to give you an inside look at what goes on in one of those "black holes." Just climb aboard your spaceship with FTL (faster than light) speed for an adventure.

*Wormhole* is a space game which derives its title from the space-time surrounding the ship, which, in theory, is formed in a "tube," similar to that inhabited by Earthbound worms. As you zoom into the meandering tube, you start collecting points because your ship collects "gold dust" that is formed when the FTL drive compresses space-time into the vacuum. As you attempt to negotiate the course, you are subject to a barrage of gold nodules, which appear when you least expect them. Blasting them into bits transforms them into valued objects, giving you one to nine points for each piece captured in the handy "jaws" attached to the nose of your spaceship. If you are careless and collide with one of them, however, your ship will suddenly drop below light-speed and sustain major damage, costing up to 50,000 points.

The ship is controlled by the right joystick, and easily so, I would add. The problem is when you take your eyes off of it for a second to check your score in the upper right part of the screen: Crash! Blinding lights! The ship blinks off and on, hangs for a second and the screen echoes disaster, displaying a dazzling array of color that is rivaled only by *2001: A Space Odyssey*.

There's really no problem, because as the screen says, you can press any key to continue. You only lose 50,000 points when you're knocked out of the hole. You start with three million and it's easy to recapture lost ground with a feature that enables you to gain speed during the game. Simply pressing "S" allows you to slow down if you feel you're losing control.

If the telephone rings and you're forced to leave the game for a few minutes, pushing the *BREAK* key allows you to freeze the game and retain your points until you return. It's also useful if you feel you're losing your concentration. The game does proceed rather rapidly and you are on constant alert.

You are able to move your ship faster by moving it up and down with your joystick—up or down and backward and forward. The "bursts" of speed gained via this method are recorded in the lower left part of the screen.

Another feature you'll like, and which may explain why you may need to use the *BREAK* key occasionally, is that there is no real end to the game—unless you get a minus score. Scores above 10 million are possible for the expert, but if you go over that figure, the scoreboard will display characters whose codes are 58 and higher (inverse colon ":", etc.). The window can hold only eight characters.

The creators of this fascinating game have been thoughtful enough to see to it that as many of us as possible can enjoy *Wormhole*, providing different commands for 16K Color BASIC, for 16K Extended BASIC, and, for those fortunate enough to have 32K. The man himself, John Bobst, explains that the set-up differences are needed because the game uses the area from 7168 to 16383 for program and Hi-Res screen. For 16K either BASIC or Extended BASIC, the hardware stack would be wiped out if the stack moved up. For 32K systems, the stack is initialized much higher up in memory and is safe from being overwritten.

Showing a strong trust in CoCo owners, Bobst graciously provides details on how to *CSAVEM* (cassette) or *SAVEM* (disk) a game in progress or to make a backup copy, insuring that his creation will have a long life.

*Wormhole* is well-conceived playing wise, has great graphics, strong sound effects, and will keep you transfixed for hours that pass by quickly.

(Zeta Software, P.O. Box 3522, Greenville, SC 29608, \$17.95 on tape, plus \$2.50 S&H)

—Charles Springer

### CZAP

A disk inspect/modify routine. Learn how disks work, fix problems on your disks. \$9.95

### NEATDIR

Places the file names in your disk directories in alphabetical order. Keep your disks in order. \$6.95

### TREK80C

The classic game. Real time, moving Klingons and action graphics. \$14.95

### COPYTAPE

Copy, merge, and backup your tape based software Works even with popular pre-loader tapes. \$9.95

### BACKUP

Speed up disk backups, recover crashed disks. Bypass I/O errors and fix your disks. \$9.95

Send Check or Money Order To:

**A. M. Hearn Software**  
602 S. 43<sup>rd</sup> St.—Dept. R  
Philadelphia, PA 19143  
Write For Free Catalog

### CATALOG

An automatic disk file cataloging system. File the directories of your disks. \$9.95

### OFFLOAD

Create tape backups of your disks. A disk to tape, tape to disk copy system. \$9.95

### WWIII

Save the world from nuclear destruction. Try to win the all out war with the USSR. \$9.95

Write for free catalog of these and other products. Dealer inquiries invited.



## **"TRS-80 COLOR COMPUTER PRODUCTS" "THE 1248-EP EPROM PROGRAMMER"**

The 1248-EP EPROM PROGRAMMER is a full function unit that is compatible with virtually all popular 1K, 2K, 4K & 8K -by-8, 24 pin, 5 volt EPROMS. Compatible devices are 2508's, 2758 -0/1's, 2516's, 2716's, 2532's, 68732-0/1's, 68764's, and 68766's. Components 2732, 2732A, 2564, and 2764 are compatible via adapters (not supplied). The programmer is totally menu driven by resident position independent firmware in EPROM, which makes it suitable for experienced computer operators and novices alike.

Select the device type to be programmed from the device menu. Next, select the function to be performed from the function menu. On your command the 1248-EP will verify EPROM erasure, compare EPROM contents to specified contents of RAM or ROM, program blocks or individual bytes of EPROM memory or copy an EPROM's contents to user specified RAM.

The 1248-EP plugs into the cartridge slot of the Color Computer and is invoked by the user with the "EXEC & HCOO" BASIC command. The 1248-EP contains its own on-board programming power supply, and has a quality "Zero Insertion Force" socket.

The combination of the TRS-80 Color Computer, an editor/assembler/monitor such as the Micro Works SDS80C\*\* and the 1248-EP EPROM programmer, makes a high performance, cost effective software development station for MC-6800/6809 microprocessor based systems. Use the system to store your own games or utility programs in EPROM's for execution from the cartridge slot using the CK4 PROM/RAM card described below.

The cost of the 1248-EP EPROM PROGRAMMER, instructions and adapter diagrams is just \$99.95.

### **"THE CK4 PROM/RAM CARD"**

The CK4 works with 2K, 4K or 8K-by-8 ROM's or EPROM's of the 5 volt only variety in 24 pin packages. In addition, the CK4 may be used with 4 static RAM's such as 6116's to expand the computers memory work space by 8192 bytes. Each of the four on-board sockets can be decoded to any 2K block of the memory map from \$C000 through \$F800 of the Color Computer. In addition, each socket can be configured to respond to address blocks from 2K to 8K bytes in length, thus accommodating 2K, 4K or 8K-by-8 ROM's, EPROM's or RAM's. ROM and RAM can be mixed on the card as well. RAM, on the card, can be written to and then "write protected" via dip switches on the CK4 to emulate ROM.

The instructions include information on how to set up the socket decoding circuitry and how to provide battery backup for programs stored in CMOS static RAM on the CK4 with the computer off or the cartridge removed.

The popular CK4 PROM/RAM card is now available in three versions.

1) The full featured CK4 remains the standard of cartridge board flexibility with the added capability of providing battery backup for CMOS static RAM's such as 6116's. Cost of the CK4 is still just \$29.95.

2) The CK4-1 is a ROM only version of the CK4 card for use with CoCo's with later than "E series" circuit boards. These later versions of CoCo are not able to write to cartridge based RAM without modification. Cost is \$27.95 for the CK4-1.

3) The CK4-2 is the unpopulated CK4 series circuit board only. Buy this version of the CK4 and configure them to meet your specific requirements at a price designed to stretch your dollars value. Cost is \$15.95 each.

### **"MORSE ENCODER/DECODER KIT"**

The MEDK80 Morse En/Decoder Kit consists of a machine code software driver on tape, a schematic diagram of the interface circuitry, component parts, a printed circuit board (PCB), packaging suggestions and complete instructions for building a Morse code transmission and reception system that is compatible with 4K RAM and up models of the TRS-80 Color Computer.

The transmitter/receiver interface circuitry is totally optically isolated and is, therefore, compatible with all receivers and transmitters. Transmitter and receiver both connect to the interface unit and to the Color Computer via the RS-232 port.

The MEDK80 Morse En/Decoder kit operates at speeds up to 70 words per minute and automatically adapts to speed variations of the sender. When transmitting, words are transmitted only when fully formed, i.e., followed by a space, and the transmit text buffer gives visual notification to the operator of what word/character is currently being sent. In addition, the text buffer is 512 characters deep, which is sufficiently large to keep up with the best of "rag-chewers".

Potential purchasers of this product should have previous kit building experience. However, this is not a kit of great complexity, and is well within the abilities of those actively involved in amateur radio or electronic hobbies to construct. To reduce the chance of wiring errors, component placement is indicated on the PCB and detailed assembly instructions are included.

The cost of the MEDK80 software, parts, and instructions is \$39.95.

### **"COCO" GETS A BREADBOARD**

The COCO BREADBOARD is a circuit board that plugs directly into the cartridge slot of the Color Computer and provides the user with 16 square inches of predrilled breadboarding area for circuit development, interfacing experiments, motherboard implementation, or whatever your imagination conjures up. The plated thru holes in the breadboard are wirewrap pin compatible and on 0.10 inch centers.

The COCO BREAD BOARD brings all of the data, address, and control signals available at the cartridge slot outside of the body of the computer and the signal lines are appropriately labeled to facilitate error free wiring of breadboards. A ground plane is provided on the top side of the board and solder pads are provided on the bottom of the board, thus facilitating circuit grounding and point-to-point wiring. In short, the COCO BREADBOARD was designed with the experimenter in mind.

The COCO BREADBOARD is attractively priced to justify its use for even the lowest budget projects. It is an ideal vehicle for learning interfacing techniques. Buy extras to have on hand for those rainy weekends.

The COCO BREADBOARD costs just \$19.95. Price for two (2) or more is \$16.95 each.

### **FACTORY FRESH COMPONENTS:**

ITEM	DESCRIPTION	PRICE
2716 EPROM	2K by 8 Bit, 350 ns	\$4.50 ea.
2532 EPROM	4K by 8 bit, 350 ns	\$6.50 ea.
6821P	P.I.A.	\$3.50 ea.
74LS156	Open collector decoder	\$1.70 ea.
Socket	ZIF, 24 pin, Aries	\$7.95 ea.

Minimum component order: \$25.00

### **ORDERING INFORMATION:**

Add \$3.00 to all orders to cover shipping and handling. Allow two weeks for personal checks. Canadian residents add 5% to cover special handling. Arizona residents add 4% sales tax. Sorry! No charges accepted. All items shipped UPS.

Make checks payable to:

**COMPUTER ACCESSORIES OF ARIZONA  
5801 E. VOLTAIRE DRIVE  
SCOTTSDALE, ARIZONA 85254  
(602) 996-7569**

\* TRS-80 is a trademark of TANDY CORP.  
\*\* SDS80C is a trademark of the MICRO WORKS.  
Prices subject to change without notice.



# Beyond The 'Vaders'

By Dennis S. Lewandowski  
Rainbow Contributing Editor

This month we are going to add a couple of rows to our Invaders, and give them the ability to move to the bottom of the screen (and beyond if we let them). This is also the place where we are going to leave them. Starting next month we are going to switch the format around a little bit. We will take a short BASIC program, and convert it to Machine Language. The reason, it seems, is that we have left many possible programmers out of Machine Language due to the increasing complexity of this game program. This format will be easier to follow as each article will not depend upon the information contained in previous issues. You still will need to know how to use an Editor/Assembler, or a monitor program to enter the programs into the computer. Rather than explaining how an E/A or monitor works each couple of articles, a pamphlet will be made available, with a notice of how to obtain it contained at the end of each article. The pamphlet is still in the works and will be available by April (which is also the month of the RAINBOWfest, what a coincidence!).

Now, about the program. As I said, this is where I shall leave it. However, if someone wishes to finish it, *the Rainbow* and I would be more than happy to publish the listing. The items still needed are: Invaders firing down, Sound, and Scoring. Fairly simple? Good; let's see your version. I'm sure we could arrange some sort of prize or something for anyone who wishes to try their hand at it. The listing itself is rather lengthy and if you have been following the series you know that lines ending in asterisks are additions to the previous listing. So have fun—after all, that's what this computer is for.

The listing:

```

0002 0E00          NAM SPACE
0003 0E00          HYRES EQU $E00
0004 0300          VAR EQU $300
0005 0302          NEWPL EQU $302
0006 0304          COUNT EQU $304
0007 0306          POS EQU $306
0008 030B          NWPOS EQU $30B
0009 030A          HITS EQU $30A
0010 00B0          SHOT EQU $B0
0011 0E00          ORB $1A00
0012 1A00 86C0     START LDA $86C0     MEDIUM BRAFICS
0013 1A02 B7FF22   STA $FF22           SET CONTROL
0014 1A05 B7FFC7   STA $FFC7           MOVE SCREEN UP
0015 1A08 B7FFC9   STA $FFC9           INTO HIGH MEM
0016 1A0B B7FFCB   STA $FFCB           FOR DISK USERS
0017 1A0E B7FFC5   STA $FFC5           SET VDB
0018 1A11 CC0000   SCRN LDD $0         PUT 0 IN D
0019 1A14 B70300   STA VAR            PUT 0 IN VAR
0020 1A17 FD0306   STD POS           ZERO IT
0021 1A1A FD0308   STD NWPOS         ZERO IT
0022 1A1D FD030A   STD HITS          ZERO HITS
0023 1A20 8E0E00   LDX $HYRES        PUT START IN X
0024 1A23 ED01     PCLS STD ,X++      DOUBLE TIME
0025 1A25 8C1A00   CMPX $1A00        END OF SCRNM
0026 1A28 26F9     BNE PCLS          CLEAR THAT SCRNM
0027 1A2A 8E19AE   LDX $19AE         START POS'IN
0028 1A2D BF0302   STX NEWPL         SAVE LOCATION
0029 1A30 100E1ABC LDY $BASE         GET BASE BRAFIC
0030 1A34 8D3B     BSR DRBS          DRAW BASE

```

```

0031 1A36 8608     LDA $0
0032 1A38 B70304   STA COUNT
0033 1A3B 8E0E20   LDX $0E20        VADR START
0034 1A3E BF0306   STX POS          SAVE POS
0035 1A41 8D17     BSR VLOOP        DIPLAY ROW****
0036 1A43 8608     LDA $0           ANOTHER ROW*****
0037 1A45 B70304   STA COUNT        SET#*****
0038 1A48 8E0E00   LDX $EE0        2ND ROW*****
0039 1A4B 8D0D     BSR VLOOP        DISPLAY ROW****
0040 1A4D 8608     LDA $0           THIRD ROW*****
0041 1A4F B70304   STA COUNT        SET #*****
0042 1A52 8E0FA0   LDX $FA0        3RD ROW*****
0043 1A55 8D03     BSR VLOOP        DISPLAY*****
0044 1A57 7E1AA5   JMP GETKEY       START GAME***
0045 1A5A BF0308   VLOOP STX NWPOS    SAVE HERE TO
0046 1A5D 100E1A9C LDY $VADER       GET GRAPHIC
0047 1A61 8D11     BSR LOOP        DISPLAY IT
0048 1A63 7A0304   DEC COUNT       8 YET?
0049 1A66 2708     BEQ NXROW       REPLACE OLD***
0050 1A68 8E0308   LDX NWPOS       GET POS
0051 1A6B C602     LDB $2          NEXT POSITION
0052 1A6D 3A       ABX             ADD TWO
0053 1A6E 20EA     BRA VLOOP       TILL DONE
0054 1A70 39       NXROW RTS        DONE WITH ROW*****
0055 1A71 9E0302   DRBS LDX NEWPL   GET BASE POS'IN
0056 1A74 A6A0     LOOP LDA ,Y+     PUT GRAFIC IN A
0057 1A76 8100     CMPA $0         CLS GRAPHIC
0058 1A78 2708     BEQ OK          LET IT PASS
0059 1A7A 8101     CMPA $1         ARE WE DONE
0060 1A7C 2708     BEQ DONE
0061 1A7E 8120     CMPA $20        IS IT OFFSET
0062 1A80 2505     BLO OFFSET     THEN DOIT
0063 1A82 A780     OK STA ,X+       IF NOT DISPLAY IT
0064 1A84 20EE     BRA LOOP        NEXT BRAPHIC
0065 1A86 39       DONE RTS        RETURN
0066 1A87 1F09     OFFSET TFR A,B  SWITCH A WITH B
0067 1A89 3A       ABX             ADD B & X
0068 1A8A 20E8     BRA LOOP        CONTINUE
0069 1A8C 801E     BASE FCB $0,$1E TOP & OFFSET
0070 1A8E 2AAA1E   FCB $2A,$AA,$1E MIDDLE
0071 1A91 2AAA01   FCB $2A,$AA,1   BOTTOM
0072 1A94 001E     CLNUP FCB 0,$1E  TOP
0073 1A96 00001E   FCB 0,0,$1E    MIDDLE
0074 1A99 000001   FCB 0,0,1      BOTTOM
0075 1A9C 76001E   VADER FCB $76,0,$1E TOP
0076 1A9F 55001E   FCB $55,0,$1E MIDDLE
0077 1AA2 410001   FCB $41,0,1    BOTTOM
0078 1AA5 7C0304   BETKEY INC COUNT  TIMER
0079 1AAB 2771     BEQ CHECK       IS IT TIME?***
0080 1AAA BDA1C1   JSR $A1C1       INKEY$
0081 1AAD 27F6     BEQ BETKEY
0082 1AAF 8109     CMPA $9         RT ARROW?
0083 1AB1 2710     BEQ MOVRT       MOVE RIGHT
0084 1AB3 8108     CMPA $8         LF ARROW?
0085 1AB5 2728     BEQ MOVLF       MOVE LEFT
0086 1AB7 8120     CMPA $120       SPACE?
0087 1AB9 2741     BEQ FIRE        SHOOT SHOT
0088 1ABB 8158     CMPA $158       X?
0089 1ABD 102700C0 LBEO BACK       EXIT
0090 1AC1 20E2     BRA BETKEY      NONE OF ABOVE
0091 1AC3 8E0302   MOVRT LDX NEWPL  BET CURRENT LOC
0092 1AC6 8C19BF   CMPX $19BF     RT LIMIT
0093 1AC9 27DA     BEQ BETKEY     TO FAR
0094 1ACB 100E1A94 LDY $CLNUP     BLANK GRAPHIC
0095 1ACF BDA0     BSR DRBS       ERASE OLD POS'IN
0096 1AD1 7C0303   INC NEWPL+1    ONE PLACE

```

**ADVENTURES**

16K CIRCUS ADVENTURE \$9.95  
A child's adventure game with many songs, graphics, and surprises. Meet all of your circus favorites while searching for the popcorn man. Great family fun for all ages.

16K SCHOOLMAZE ADVENTURE \$11.95  
While in search of a lost computer tape, you travel in a school and draw pictures, compose songs, play basketball, and use the keyboard to travel in the hallways.

**GAMES**

COCO-JOT by Steve Greenberg  
16K \$11.95  
A new version of the famous Jotto word game. A guessing game using your powers of reasoning and deduction. 1 or 2 player game. Different levels of play. Ages 8 to adult. User modifiable.

"FROG-MAN" by Carsten Lawrenz  
16K Ext. Basic \$11.95  
Lively, action packed, joystick controlled game. 7 levels of difficulty and timer. Best score displayed. Get your frogs safely home through several interesting obstacles.

\*\*\* NEW \*\*\*  
**SOFTWARE FOR SPECTRUM'S LIGHT PEN**  
KID'S FUN-PAK: This 3 program game set will entertain you with a great new dimension for your computer. Tutorial included with documentation.  
Kid's Fun-Pak Tape 16K Ext. \$14.95  
Light Pen and Tape \$34.95



**LEARNING PROGRAMS FOR HOME OR SCHOOL**

FOREIGN LANGUAGE GAMES 16K or 16K Ext. \$11.95  
FRENCH BASEBALL — Score base hits or home runs for correct answers. You're out if wrong. Correct answers supplied. Fun way to learn and practice vocabulary. 2 levels.  
SPANISH BASEBALL — Same game using Spanish vocabulary words.  
ITALIAN BASEBALL — Same game using Italian vocabulary words.

User Modifiable.

**PLEASE SPECIFY LANGUAGE AND VERSION**

HEBREW BULLETIN BOARD 16K Ext. \$15.95  
by Joseph Kolar and Steve Blyn  
A utility that will enable YOU to create Hebrew or Hebrew/English words, flash cards, sentences, greeting cards, etc. in Hi-res. Easy to learn-full documentation. For hard copy, use your printer and any screen print program.

Computer Island Presents  
**THE BEST IN SOFTWARE FOR KIDS!**

\*\*\* SPECIAL CLOSEOUT \*\*\*  
\* \* \* \* \*  
\* Two never released hi-res. \*  
\* machine language 2-player, \*  
\* joystick, arcade games from \*  
\* Creative Computing. \*  
\* 1. PICNIC- Escape the evil \*  
\* spider and capture foods. \*  
\* 2. TRICKASHAY- A tank duel \*  
\* in a tricky maze. \*  
\* 16- K Extended \*  
\* Both for an incredibly \*  
\* low price of \$11.95 \*  
\*\*\*\*\*

COMPUTER ISLAND  
DEPT. R  
227 Hampton Green  
Staten Island, N.Y. 10312

(212) 948-2748



DOLLARS AND SENSE 16K Ext. \$11.95  
Learn to make purchases. Graphic displays of items kids love. Player buys using dollars and coins to practice using money correctly. Solutions given.

McCOCO'S MENU 16K Ext. \$11.95  
America's favorite pastime — going out to eat! Learn to buy and add up your purchases from a typical fast food restaurant menu. Gain skill in using money. Different prices each time.

ADDITION AND SUBTRACTION 16K \$11.95  
Menu driven, 2 level program provides practice in adding or subtracting 2 digit numbers. Vertical format for proper entry of digits in the answers. Report card scoring.

READING 2-PAK 4K \$9.95  
POETRY and SILLY SENTENCES: Any child can create his own original reading material about familiar people and things through user input.

READING GAMES 2 Pack 4K \$9.95  
Silly Stories and Wizard: These games provide practice in reading simple stories and phrases. User input make these games personal and fun and keep your child interested in reading the results.

**BOOK**

**A BYTE OF COLOR BASIC**  
by Steve Blyn

A work-text containing — instruction, examples, illustrations, programs, and many practice exercises. 3 Units — Basic, Graphics, and Sound. 24 chapters to teach you what you need to know to begin reading, understanding, and writing your own programs. Answer Key included with each book. Great book for beginners. \$4.95 NEW LOW PRICE

SCHOOL DISCOUNTS

**MUSIC**



**NAME THAT SONG GAMES**

16K Extended \$9.95 each  
1. 72 children's popular songs. 2 levels of difficulty. Timer. Many hours of fun.  
2. 72 all time pop, country, and movie melodies from the last three decades.  
3. 60 Broadway Show tunes to test you on past musicals. Fun for all trivia buffs.

FREE set of BINARY DICE including full directions when ordering any 2 items !!!

DEALERS INQUIRIES INVITED  
N.Y. Residents, please add proper tax  
Please add \$1.00 per order for postage

**PRESCHOOL**

PRESCHOOL PACK 1 by Joseph Kolar  
16K Ext. \$11.95  
Clown and Fish-Mum: Two programs to help your child recognize and count the words and numbers 1 - 10. Hi-res graphics and lively songs help to attract and keep attention.

PRESCHOOL PACK 2 by Joseph Kolar  
16K Ext. \$11.95  
Count Kids and Add Penny: Two programs to help your child count and add up to 10. Beautiful hi-res graphics.

PRESCHOOL PACK 3 by Joseph Kolar  
16K Ext. \$11.95  
Alpha-Byte: Programs designed to teach recognition and identification of the alphabet. Attractive hi-res graphics.

MUSIC MARVEL 16K Ext. Basic \$9.95  
Play 2 familiar children's songs. Large graphic displays. No reading or musical ability needed. Great for pre-schoolers. 16K version also available. Please specify.

Authors: We are seeking quality children's software for leisure or learning. Write for details. Top royalties.

0097 1AD4 BE0302	LDX NEWPL	GET POSITION
0098 1AD7 10BE1ABC	LDY #BASE	GET GRAPHIC
0099 1ADB 8D94	BSR DRBS	DISPLAY IT
0100 1ADD 20C6	BRA GETKEY	DONE
0101 1ADF BE0302	MOVLF LDX NEWPL	GET CURRENT LOC
0102 1AE2 BC19A1	CMPX #19A1	LF LIMIT
0103 1AE5 27BE	BEQ BETKEY	TOO FAR
0104 1AE7 10BE1A94	LDY #CLNUP	BLANK BASE
0105 1AEB 8D84	BSR DRBS	ERASE

0106 1AED 7A0303	DEC NEWPL+1	ONE SPACE
0107 1AF0 BE0302	LDX NEWPL	GET LOCATION
0108 1AF3 10BE1ABC	LDY #BASE	GET GRAPHIC
0109 1AF7 8D1A71	JSR DRBS	DISPLAY
0110 1AFA 20A9	BRA BETKEY	DONE
0111 1AFC FC0302	FIRE LDD NEWPL	BET BASE LOC
0112 1AFF B30020	LOOP1 SUBD #020	NEXT LINE UP
0113 1B02 10B30E00	CMPD #00E00	TOP OF SCREEN
0114 1B06 259D	BLO GETKEY	BACK TO MAIN
0115 1B0B 1F01	TFR D,X	SWITCH X & D
0116 1B0A E6B4	LDB ,X	HIT?
0117 1B0C 2E56	BGT HIT	IF DO IT
0118 1B0E B600	LDA #000	SHOT GRAPHIC
0119 1B10 A7B4	STA ,X	DISPLAY SHOT
0120 1B12 4A	LOOP2 DECA	SMALL WAIT
0121 1B13 26FD	BNE LOOP2	SO WE CAN SEE
0122 1B15 A7B4	STA ,X	CLEAN UP SHOT
0123 1B17 1F10	TFR X,D	SWITCH BACK
0124 1B19 20E4	BRA LOOP1	TO THE TOP
0125 1B1B BE0306	CHECK LDX POS	GET LINE ADR****
0126 1B1E 3610	PSHU X	SAVE ADDRESS*****
0127 1B20 8D24	BSR MOVE	DO FIRST ROW***
0128 1B22 BE0306	LDX POS	GET ADDRESS*****
0129 1B25 C6C0	LDB #0C0	SKIP 2 ROWS*****
0130 1B27 3A	ABX	X+B=NEXT ROW*****
0131 1B28 3610	PSHU X	SAVE ADDRESS*****
0132 1B2A 8D1A	BSR MOVE	DO 2ND ROW*****
0133 1B2C FC0306	LDD POS	GET ADDRESS*****
0134 1B2F C30180	ADD #0180	OFFSET FOR 3*
0135 1B32 1F01	TFR D,X	PUT RESULT IN X*
0136 1B34 3610	PSHU X	SAVE ADDRESS*****
0137 1B36 8D0E	BSR MOVE	DO 3RD ROW*****
0138 1B3B 7C0307	INC POS+1	ADVANCE*****
0139 1B3B 2703	BEQ FIX	MOVED 255 YET?*
0140 1B3D 7E1AA5	JMP GETKEY	RET TO MAIN**
0141 1B40 7C0306	FIX INC POS	ADJUST MSB*****
0142 1B43 7E1AA5	JMP GETKEY	RET TO MAIN**
0143 1B46 B660	MOVE LDA #060	# OF BYTES
0144 1B4B B70301	STA VAR+1	SAVE #
0145 1B4B A680	LDA ,X+	GET BYTE
0146 1B4D E6B4	AA LDB ,X	GET NEXT BYTE
0147 1B4F A7B0	STA ,X+	MOVE BYTE
0148 1B51 7A0301	DEC VAR+1	COUNTER-1
0149 1B5A A684	LDA ,X	GET ANOTHER
0150 1B56 E780	STB ,X+	PUT IN POS'N
0151 1B58 7A0301	DEC VAR+1	ONE DONE
0152 1B58 26F0	BNE AA	DONE YET?
0153 1B5D 3710	PULU X	GET LINE ADR*****
0154 1B5F B600	LDA #0	BLANK GRAPHIC
0155 1B61 A7B4	STA ,X	CLEAN START POS
0156 1B63 39	RTS	THIS IS NOW A SUB***
0157 1B64 7C030A	HIT INC HITS	# OF HITS
0158 1B67 1F10	TFR X,D	SWITCH X&D
0159 1B69 830040	SUBD #040	POSITION
0160 1B6C 1F01	TFR D,X	BACK IN X
0161 1B6E 10BE1A94	LDY #CLNUP	GET BLANK
0162 1B72 8D1A74	JSR LOOP	ERASE VADER
0163 1B75 B6030A	LDA HITS	GET NUMBER
0164 1B78 8118	CMPA #018	ALL DONE?*****
0165 1B7A 1027FE82	LBER START	GO AGAIN
0166 1B7E 7E1AA5	JMP GETKEY	GOTO MAIN
0167 1B81 0A71	BACK DEC \$71	-1 RESTART VECTOR
0168 1B83 7EA027	JMP #A027	BACK TO BASIC
0169 1B86	END START	

# GOLDLABEL™ BLANK CASSETTES

★PREMIUM 5 SCREW SHELL  
★COMPUTER DATA QUALITY ★LOW NOISE  
★MADE IN USA ★GUARANTEED

1 DOZEN C-10 LENGTH \$8.50 + \$2.50 shpg.  
2 DOZEN C-10 LENGTH \$16.00 + \$3.50 shpg.

1 DOZEN C-30 LENGTH \$12.50 + \$2.50 shpg.  
2 DOZEN C-30 LENGTH \$23.50 + \$3.50 shpg.

Individual storage boxes (sold only with cassettes) \$2.40 per dozen.  
CASSETTE CADDY: \$3.95 + \$2.00 shpg.  
2 for \$7.00 + \$3.00 shpg.

Free shipping on one caddy with each dozen cassettes.

Foreign orders include shipping at 16 oz. per dozen tapes/9 oz. per caddy/13 oz. per dozen boxes. Shipped in U.S. by UPS.

## CASSETTE CADDY

TIRED OF MISPLACED TAPES AND A CLUTTERED WORK AREA? TRY OUR HINGED TOP SMOKED PLASTIC CADDY THAT HOLDS 12 TAPES IN ONE HANDY LOCATION. EDGE LABELS INCLUDED TO IDENTIFY TAPES.

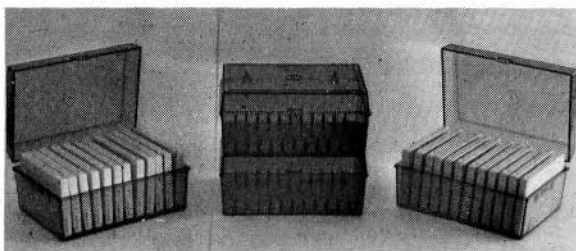

Visa and Mastercard accepted (include expiration date) Orders paid by cashier's check, money order or bankcard are shipped within 48 hours. Personal check takes 1-2 wks. No COD. Some foreign sales are restricted. Texas residents add 5% tax.

**COLOR SOFTWARE SERVICES**  
P.O. BOX 1708, DEPT. R  
GREENVILLE, TEXAS 75401

Telephone Orders: (214) 454-3674 9-4 Monday-Saturday

★DEALER INQUIRIES INVITED ★QUANTITY DISCOUNTS AVAILABLE

NO ERRORS FOUND

# 80-U.S.

THE TRS-80 USERS JOURNAL

If you own a TRS-80® Model I, Model II, Model III, the Color Computer, or the new Pocket Computer, YOU NEED 80-U.S.!

## The 80-U.S. Journal has

programs for your enjoyment and enlightenment. Every issue contains several Basic or machine language program listings. It contains Business articles and program listings. No matter where you are, there is something for YOU in the Journal!

*and...*

The Journal contains reviews of hardware and software. Our "Evaluation Reports" will help you make the best choice in selecting additions to your system.

## Save Over 50%

You can save over 50% off the cover price of *80-U.S. Journal*. For the remarkably low price of *only* \$16.00, a savings of \$20.00 (cover price), you will receive a wealth of useful information every month. As a special **BONUS**, if you enclose payment with your order, you will receive an extra issue for each year of your subscription order. *Order three years of 80-U.S. and receive three extra issues! At no cost to you!*

Is your  
TRS-80  
Lonely?

Write today for  
our  
"No Risk Offer"

SEND TO:

80-U.S. Journal  
3838 South Warner Street  
Tacoma, Washington 98409  
Phone (206) 475-2219

Name \_\_\_\_\_

Address \_\_\_\_\_

City \_\_\_\_\_ State \_\_\_\_\_ Zip \_\_\_\_\_

Visa/MC \_\_\_\_\_

Exp. Date \_\_\_\_\_

1 yr. \$16     2 yrs. \$31     3 yrs. \$45

Please allow 6 to 8 weeks for your first issue.

TRS-80 is a Registered Trademark of the Tandy Corp.



## "Pac" Up Your Scuba Gear

*Nibbler* and *Ms. Nibbler*, by Thomas Czarnecki, are a matched pair of maze games in which the scene of the action is an undersea pearl bed and you are a hungry oyster merrily eating sand to make your pearls. But, all is not well in "oyster-dom," for lurking in a cave in the center of your pearl bed are three Sand Monsters who just *love* raw oysters. Your only hope for survival is to evade your pursuers until you can get to one of the four Magic Catalyzer pellets which lie in the four corners of the maze. Then you become not only immune to the Monsters, but also suddenly hungry *for them!* Well, if this scenario doesn't seem vaguely familiar, then you *obviously* haven't been inside an arcade in quite a while.

Both of these Machine Language games are basically the same except that *Nibbler* uses color-set one while *Ms. Nibbler* offers color-set two, a different maze and *Ms. Nibbler* wearing pink lipstick. The programs are auto-executing with very good title graphics that really show what can be done with Color BASIC's CHR\$ graphics. The animation is smooth with very little flicker and the game

graphics are good, especially the Sand Monsters, which are slightly "space invaderish." The joystick action is *quite* good and won't "hang up" on those quick corners (unlike some "Pac" games I've seen) even with "Shack" joysticks.

The scoring is well explained in the documentation which is identical for both games. You get 15 points for each pile of sand (dot) turned into a pearl and there is a starfish worth 500 points that randomly appears for short lengths of time just below the Monster Cave. The catalyzers are worth 30 points, and while "catalyzed," the value for eating Sand Monsters is 100 for the first one and then doubles for each additional one you get before the effect wears off (you can tell when your time is running out because your shell "clatters" audibly). There is on-screen scoring and a "Top Ten" roster at the end of the game where up to three initials may be entered.

Due to the similarity of these two games I would really recommend buying only one or the other (unless you have the \$\$\$...but, they *are* different). As to which one, it all depends. *Nibbler*, due to its color set, is a better choice if you are limited to a B/W TV, but I found the *Ms.-Maze* to be a little tighter and more of a challenge. All in all, they are both good renditions of the arcade game and would make a nice addition to the game shelf of anyone looking for an enjoyable "Pac" type game.

Happy Nibbling!

(Nelson Software System, 9072 Lyndale Ave. So.,  
Minneapolis, MN 55420, \$24.95 tape, \$29.95 disk plus  
\$3.00 p/h)

—Bruce Sterling

# The Original FLEX for Color Computers

- \* Upgrade to 64K
  - \* RS to FLEX, FLEX to RS file transfer ability
  - \* Create your own character set
  - \* Automatic recognition of single or double density and single or doubled sided
  - \* All features available for either single or multiple drive systems
  - \* Settable Disk Drive Seek Rates
  - \* Faster High Resolution Video Display with 5 different formats
  - \* Save RS Basic from RAM to Disk
  - \* Move RS Basic to RAM
  - \* Load and save function on FLEX disk
  - \* 13 Support Commands 8 with Source Text
- Languages Available

Pascal, Fortran, RS Basic, RS Assembler, TSC Basic, TSC Assembler, Relocating Assembler, Macro Assembler, Mumps

If you are tired of playing games on your TRS-80C™ Color Computer, or find that you are handicapped by the limitations of the RS BASIC in trying to write a program that will allow you to actually USE the Color Computer as a COMPUTER, YOU ARE READY TO MOVE UP TO THE FLEX9™ Operating System. If you want to have REAL PROGRAMMING POWER, using an Extremely Powerful Business BASIC, PASCALS, C Compilers, a full-blown Macro Assembler with a Library capability so you are not continuously reinventing the wheel, YOU ARE READY TO MOVE UP TO THE FLEX9™ Operating System. If you would like to see if YOU REALLY COULD USE A COMPUTER IN YOUR BUSINESS, or begin to make your Computer start PAYING ITS OWN WAY by doing some Computer Work for the millions of small businesses around you, such as Wordprocessing, Payroll, Accounting, Inventory, etc., then YOU ARE READY TO MOVE UP TO THE FLEX9™ Operating System. How?? DATA-COMP has the way!

DATA-COMP's FLEX9™ Conversion for the TRS-80C™ Color Computer was designed for the SERIOUS COMPUTER USER, with features like greatly increased Display Screens, WITH Lower Case Letters, so you can put a FULL Menu on ONE Screen, or see SEVERAL Paragraphs at the same time, with features like providing a FULL Keyboard so you have FULL Control of your Computer AND its Programs NATURALLY, without needing a chart to see what Key Combination will give you what function; with USER ORIENTED functions to make using the Operating System natural, like having the Computer AUTOMATICALLY determine what type of Disk is being used in what type of Disk Drive and working accordingly, rather than you have to specify each and every thing for it, or like having the Computer work with the Printer you have been using all along without you having to tell the new Operating System what is there, etc., etc., etc.

DATA-COMP has everything you need to make your TRS-80C™ Color Computer WORK for YOU, from Parts and Pieces to Full, Ready To Use SYSTEMS, DATA-COMP designs, sells, services, and SUPPORTS Computer SYSTEMS, not just Software. CALL DATA-COMP TODAY to make your Computer WORK FOR YOU!

### System Requirements

FLEX9 Special General Version x Editor & Assembler (which normally sell for \$50.00 ea.)	\$150.00
F-MATE(RS) Conversion Rout. for the RS Disk Controller when purchased with Special General FLEX9 Sys	\$69.95
when purchased without the General FLEX9 Sys	\$79.95
Set of Eight 64K RAM Chips w Mod Instructions	\$99.95
Color Computer with 64K RAM and EXT. BASIC	\$549.95
Color Computer with 16K RAM	\$375.95
Color Computer with 16K RAM and EXT. BASIC	\$465.95

### Now Available Enhanced F-MATE Version 2.1

#### SPECIAL SYSTEM PACKAGES

64K Radio Shack COLOR COMPUTER, Radio Shack COLOR DISK CONTROLLER, a Disk Drive System, Special General Version of FLEX9™, F-MATE(RS)™ and a Box of 10 Double Density Diskettes: a COMPLETE, ready to run SYSTEM on your Color TV Set. \$1249.95

#### DISK DRIVE PACKAGES, etc.

These Packages include the Radio Shack Disk Controller, Disk Drives with Power Supply and Cabinet, and Disk Drive Cable:	
PAK #1 — 1 Single Sided, Double Density Sys.	\$499.95
PAK #2 — 2 Single Sided, Double Density Sys.	\$769.95
PAK #3 — 1 Double Sided, Double Density Sys.	\$599.95
PAK #4 — 2 Double Sided, Double Density Sys.	\$949.95

#### PARTS AND PIECES

Radio Shack Disk Controller	\$179.95
1 ea. Single Sided, Double Density Disk Drive	\$249.95
1 ea. Double Sided, Double Density Disk Drive	\$349.95
Single Drive Cabinet with Power Supply	\$89.95
Double Drive Cabinet with Power Supply	\$109.95
Single Drive Disk Cable for RS Controller	\$24.95
Double Drive Disk Cable for RS Controller	\$34.95
Micro Tech. Prods., Inc. LOWER CASE ROM Adapter	\$74.95
Radio Shack BASIC Version 1.1 ROM	\$34.95

**DATA-COMP**

P.O. Box 794 HIXSON, TN 37343

1-615-842-4601



# TRS-80C<sup>®</sup> and TDP 100<sup>®</sup> SPECIALISTS

## COLORFORTH<sup>™</sup>

**IS THERE LIFE AFTER BASIC?** Yes! with **COLORFORTH**, a new, high level language for the color computer. **COLORFORTH**, a figFORTH compiler, has an execution time as much as 10 to 20 times faster than Basic, and can be programmed faster than Basic. **COLORFORTH** is highly modular for easy testing and debugging. **COLORFORTH** has been specially customized for the color computer and requires only 16K. It **does not** require Extended Basic. When you purchase **COLORFORTH**, you receive both cassette and RS/DISK versions, the figEDITOR and an extensive instruction manual. Both versions and 75 page manual, all for only . . . . . \$49.95

## PCFORTH

FORTH for the IBM PC<sup>®</sup> and Zenith Z-100<sup>®</sup>. All the features of **COLORFORTH**, but customized for the IBM<sup>®</sup> and Zenith Z-100<sup>®</sup> personal computers. Requires 32K and MS/DOS or IBM/PCDOS. On 5-1/4" SSDD diskette. Complete with 75 page manual, just . . . \$59.95

**new!**

## MASTER MIXOLOGIST<sup>™</sup> The Bartenders' Guide

This disk based program contains recipes for over 150 of your favorite bar drinks-both alcoholic and non-alcoholic. **MASTER MIXOLOGIST** is menu driven for ease of use. Requires 16K and one RS/DOS drive. Get this one today, it will be great for your next party . . . . . \$19.95

## ARMADILLO BUG<sup>™</sup> MACHINE LANGUAGE MONITOR

More and more programs are appearing in magazines written in Machine Language. Now with **ARMADILLO BUG**, you can easily enter Machine Language programs without a lot of time consuming "pokes". **ARMADILLO BUG** is an excellent system for beginners to learn to write and debug their own Machine Language programs as well. This package includes: Memory examine and change; Move; Punch and Load; Fill commands; and more! Runs in 16K, and **DOES NOT** require Extended Basic. Complete on cassette with printed manual. Just . . . . . \$14.95

## OTHER ITEMS OF INTEREST

"**STARTING FORTH**", a book by Leo Brodie. The best introductory Forth text available. 384 pages. Soft cover . . . . . \$16.00

## DEALER and AUTHOR INQUIRES INVITED

Please add \$2.00 shipping in U.S.

Texas residents add 5%

Foreign orders must be in U.S. funds drawn on U.S. banks, or Mastercard and VISA

## ARMADILLO INT'L SOFTWARE

P.O. BOX 7661  
AUSTIN, TEXAS 78712

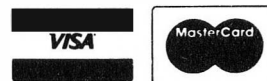

PHONE (512)459-7325



# NEW for your COLOR COMPUTER

## Release the potential of your Color Computer. . .

Use up to 5 compatible Color Computer cartridges at the same time with the BT-1000 Expansion Interface Unit.

- **The BT-1000 is limitless combinations.** Plug in your disk controller, memory boards, Real Time Clock/Calendar, printer interface, experimental boards—all at one time.
- **The BT-1000 is adaptable.** Up to five functional peripheral cartridges, in your choice of combinations, will run with any configuration, any size memory of the Color Computer.
- **The BT-1000 is flexible.** Four 24-pin sockets hold up to 8K static RAM or EPROM (can be supplied with an extra 8K RAM).
- **The BT-1000 is safe.** It will not overload, overheat or damage your Color Computer in any way.
  1. Has own built-in power supply.
  2. Effectively isolated by a buffered cable.

## That's not all Basic Technology has to offer. . .

Record date and time on all programs, files, letters, with the accurate, programmable BT-1020 Real Time Clock/Calendar.

- Plugs into your BT-1000 or directly into the Color Computer expansion slot.
- Adds day, date, month, year, hours, minutes, seconds (12/24 hr.)
- Includes internal NiCad battery, crystal controlled to 0.001% accuracy (charges when your computer is on)
- Has 50 bytes of battery backed general purpose memory

## All Basic Technology components are first-line quality.

- gold board-edge connectors
- glass epoxy PC boards
- 180-day full parts and labor warranty on all components



Your **Basic Technology** components arrive assembled, tested, ready to plug in and turn on. A comprehensive User/Service Manual is included with complete schematics, PC component layouts, parts lists and hints on mapping your peripheral additions anywhere in the CPU addressable memory. Write for free brochure.

BT-1000 incl. cable \$270      BT-1020 Clock/Calendar \$109  
BT-1000 w/8K RAM \$300

Add \$5.00 shipping & handling for BT-1000, \$2.50 for BT-1020. Michigan residents add 4% sales tax. Shipping & handling for residents of Canada, Hawaii, Alaska is \$10.00. Overseas orders add 15%. Check, money order, VISA, MC (give account no., expiration date, phone no.). Personal checks allow 2-3 weeks to clear. COD charge \$2.00 (requires certified check or money order).

*"Watch for more peripherals from Basic Technology."*

**basic**  
**TECHNOLOGY**

Dept. Q P.O. Box 511 Ortonville, MI 48462

(313) 627-6146

# THESE FINE STORES CARRY THE RAINBOW

The retail stores listed below carry **the RAINBOW** on a regular basis and may have other products of interest to Color Computer users. We suggest you patronize those in your area.

- Abacus Computers**  
S. Holland, Mich.
- Accolade Distributors**  
San Diego, Calif.
- Acorn Computer Systems**  
Wauwatosa, Wisc.
- Acme Book Co.**  
Baton Rouge, La.
- A Computer Store**  
Indianapolis, Ind.
- Act One Video**  
Marietta, Ga.
- Adventure International Store**  
Longwood, Fla.
- All-Pro Souvenirs**  
Pittsburgh, Pa.
- All Systems Go**  
Orlando, Fla.
- Tempe, Ariz.**
- Alonzo Book & Periodical**  
Alexandria, Va.
- Amateur Radio Equipment Co.**  
Wichita, Kan.
- Anderson Electronics**  
Benton, Ky.
- Appalachian Computing**  
Kingwood, W. Va.
- Applefree Computers**  
DeKalb, Ill.
- Atlantic News**  
Halifax, N.S.
- Audio Concepts Unlimited**  
Denton, Tex.
- Aurora Newsland**  
Aurora, Col.
- Bauer Electronics**  
Lawrenceburg, Ind.
- B. Dalton Booksellers**  
West Jackson St. - Chicago, Ill.  
N. Wabash St. - Chicago, Ill.  
Milwaukee, Wisc.  
Peoria, Ill.
- Begley Drugs**  
Crestwood, Ky.
- B.I.E.S. Systems**  
Oak Park, Ill.
- Bits, Bytes & Nibbles**  
Spokane, Wash.
- Bill's TV Radio Shack**  
Newton, Ill.
- Bob's in Newtown**  
Chicago, Ill.
- Bob's News Emporium**  
Chicago, Ill.
- Bob's Rogers Park**  
Chicago, Ill.
- Book Market**  
East Cedar - Chicago, Ill.  
North Cicero - Chicago, Ill.  
West Diversy - Chicago, Ill.  
Peoria, Ill.
- Champaign, Ill.**
- Danville, Ill.**
- Book Nook**  
Lisle, Ill.
- Book Tree**  
Milwaukee, Wisc.
- Booked Solid**  
Milwaukee, Wisc.
- Booked Solid II**  
Milwaukee, Wisc.
- Bookland, Inc.**  
Indianapolis, Ind.
- Buffalo Technologies**  
Amherst, N.Y.
- Byte By Byte**  
Utica, Mich.
- Campus Computer Corp.**  
Nashville, Tenn.
- C&J Electronics Computer Center**  
Richland, Wash.
- C/C Computer Systems**  
Owosso, Mich.
- Capital Microcomputers**  
Austin, Tex.
- Caribbean Engineering Corp.**  
Stuart, Fla.
- Caves Books Co.**  
Hong Kong
- Chattanooga Chao-Chao**  
Chattanooga, Tenn.
- Chester Electronic Supply**  
Kenosha, Wisc.
- Chicago-Main News**  
Evanston, Ill.
- Chips, Inc.**  
Atlanta, Ga.
- CMD Micro**  
Edmonton, Alta.
- Coast Electronics**  
Morro Bay, Calif.
- Color Computing**  
Southgate, Calif.
- Color Products Unalike**  
Vancouver, B.C.
- Community News Center**  
Ann Arbor, Mich.
- Compulit**  
Burnaby, B.C.
- Computer Center**  
Albuquerque, N.M.
- The Computer Center**  
New York, N.Y.
- The Computer Center of York**  
York, Pa.
- The Computer Connection**  
Boulder, Col.
- Computer Corner**  
Lapeer, Mich.
- The Computer Experience**  
Greenwood, Ind.
- Computer Shack**  
Pontiac, Mich.
- The Computer Store**  
Louisville, Ky.
- The Computer Store**  
Phoenix, Ariz.
- The Computer Store**  
San Diego, Calif.
- The Computer Store**  
Tulsa, Okla.
- The Computer Store**  
Casper, Wyo.
- Computer Resource**  
Williamsville, N.Y.
- CompServ of Danbury**  
Danbury, Conn.
- Computer Concerns**  
Havlock, N.C.
- Computer Services**  
Lawrenceburg, Ind.
- Computer SOS**  
Shreveport, La.
- Computer Town**  
Coral Springs, Fla.
- Computers 'N' Stuff**  
Duncan, Okla.
- Computerware Store**  
Encinitas, Calif.
- Computerworx**  
Knoxville, Tenn.
- Cosmos Computers**  
Bethendorf, Iowa
- Croucher Electronics**  
Conroe, Texas
- Cudahy News & Hobby**  
Cudahy, Wisc.
- Dallas Computer Center**  
Dallas, Tex.
- Data Barn**  
Renton, Wash.
- Data Byte Computer Center**  
Beaufort, S.C.
- Data Concepts**  
Scottsdale, Ariz.
- Data Domain**  
Schauenberg, Ill.
- Data Equipment Co.**  
Downey, Calif.
- Data Link**  
Dayton, Ohio
- The Data/Phile Co.**  
East Syracuse, N.Y.
- Dave's Elect. Radio Shack**  
Pennsville, NJ
- D. Data**  
Shillwater, Okla.
- Delker Electronics**  
Smyrna, Tenn.
- Disney's Electronics**  
San Diego, Calif.
- Dimensional Software**  
San Diego, Calif.
- DSL Computer Products**  
Dearborn, Mich.
- E. B. Garcia & Associates**  
Chicago, Ill.
- The Eight Bit Corner**  
Muskegon, Mich.
- Electrobrain**  
Alwata, Calif.
- Electronic World**  
Fairbanks, Alaska
- Elx Mart**  
Jasper, Ind.
- F.M. Electronics**  
Jay, Maine
- Final Edition**  
University City, Mo.
- The Floppi Disk**  
Downey, Calif.
- Frank Hogg Laboratory**  
Syracuse, N.Y.
- Galls Book World**  
Hamilton, Ont.
- Game Preserve**  
Indianapolis, Ind.
- Gopher Hole**  
Brooklyn Center, Minn.
- The Green Dragon**  
N. Charleston, S.C.
- Guild Books and Periodicals**  
Chicago, Ill.
- Guild News Agency**  
Atlanta, Ga.
- Gulliver's Inc.**  
Hays, Kan.
- Gus-Stan Enterprises**  
Pikeville, Ky.
- H&H Co.**  
Whitehorse, Yukon
- H&H Electronics**  
Woodward, Okla.
- Hands On Computer**  
Atlanta, Ga.
- Hawley-Cook Booksellers**  
Louisville, Ky.
- Hathaway's Magazines**  
Colorado Springs, Col.
- Hi-Fi Audio Co.**  
Owosso, Mich.
- Hobby Shop**  
Hopkinsville, Ky.
- Home Computer Store**  
Westerville, Ohio
- Home Brew Computers**  
Phoenix, Ariz.
- The Homing Pigeon**  
Elgin, Tex.
- Howson's**  
Joplin, Mo.
- Hurley Electronics**  
Santa Anna, Calif.
- HW Electronics**  
Northridge, Calif.
- Independent Computer Systems**  
Winter Park, Fla.
- Indiana News**  
Indianapolis, Ind.
- Interstate Distributors**  
Billings, Mont.
- J&J Electronics Ltd.**  
Winnipeg, Man.
- John's News Stand**  
Medford, Ore.
- K&S News Stand**  
Winston-Salem, N.C.
- Kona Recreation**  
Kailua-Kona, Hawaii
- Kelly Software Distributors**  
Edmonton, Alta.
- Kroch's & Brentano's**  
South Wabash - Chicago, Ill.  
West Jackson, Chicago, Ill.  
835 N. Michigan - Chicago, Ill.  
516 N. Michigan - Chicago, Ill.  
Oak Park, Ill.  
Oak Brook, Ill.  
Skokie, Ill.  
Aurora, Ill.
- L&R Electronics**  
Grant's Pass, Ore.
- Lakewood International News**  
Lakewood, Ohio
- Leo's Book & Wine Shop**  
Toledo, Ohio
- Level IV Products**  
Livonia, Mich.
- Lewy Distributors**  
Hollywood, Calif.
- Libra Books**  
Eugene, Ore.
- Little Professor Book Center**  
Philadelphia, Ohio
- Lloyd's Radio**  
Wichita, Kan.
- Madison Books**  
Madison, Ala.
- M&W Electronics**  
Harrodsburg, Ky.
- Magnum Computer Products**  
Boise, Idaho
- Markline**  
Cincinnati, Ohio
- Merit Micro Software**  
Oklahoma City, Okla.
- Micro Byte**  
Miami, Fla.
- Microcomputer Software Center**  
Manchester, N.H.
- Microtronics**  
Lawrenceville, N.J.
- Micro Con Software Cntr.**  
Woburn, Mass.
- Microwest Distributors**  
N. Vancouver, B.C.
- Micro World II**  
Clinton, N.J.
- Mike's Electronics Distributor**  
Ft. Lauderdale, Fla.
- Mills Book Store**  
Nashville, Tenn.
- Milling's Electronics**  
Wabash, Ind.
- Steven Moreno**  
Stockton, Calif.
- Mosko's Book Store**  
Nashville, Tenn.
- Multi-Mag**  
London, Ont.
- The News Rack**  
Miami, Fla.
- News-Readers**  
Fairborn, Ohio
- Newsy**  
Philadelphia, Pa.
- Ninis Corner, Inc.**  
Cambridge, Mass.
- NORMAR**  
Wilmington, Del.
- OPAMP Technical Books**  
Los Angeles, Calif.
- Out Of Town News**  
Cambridge, Mass.
- Parkwest Books**  
Chicago, Ill.
- Parkway Drugs**  
Chicago
- PCLAR80**  
Mansfield, Ohio
- Perry's News Shop**  
Avondale, Pa.
- Personal Computer Place**  
Mesa, Ariz.
- Personal Software**  
Malvern, Pa.
- Pitt Computer & Software**  
Pleasant Hills, Pa.
- Poling Place**  
Pinellas Park, Fla.
- South Pasadena, Fla.**
- Portsmouth Computers**  
Portsmouth, N.H.
- Printers, Inc.**  
Palo Alto, Calif.
- Prism Software**  
Kincardine, Ont.
- Pro Am Electronics**  
Pacific Beach, Calif.
- Pro Electronics**  
Wayzata, Mich.
- The Program Store**  
Baltimore, Md.
- Falls Church, Va.**
- Columbus, Ohio**
- Kensington, Md.**
- Washington, D.C.**
- Programs Plus**  
Tukwila, Wash.
- Programs Unlimited**  
Mayfield Heights, Ohio
- Prospect News & Magazines**  
Milwaukee, Wisc.
- Quality Technology**  
Salt Lake City, Utah
- Radio Shack F756**  
Artesia, N.M.
- Radio Shack**  
El Cajon, Calif.
- Radio Shack**  
Freehold, N.J.
- Radio Shack**  
Martinsville, Ind.
- Radio Shack**  
Paducah, Ky.
- Radio Shack**  
Peterborough, N.H.
- Radio Shack**  
San Diego, Calif.
- Radio Shack of Scottsburg**  
Scottsburg, Ind.
- Radio Shack 7181**  
Stidell, La.
- Radio Shack & Elec. Hut**  
Kissimmee, Fla.
- Rainbow Software Services**  
Calgary, Alta.
- R&V Sound**  
Fortuna, Calif.
- Recycle Computers**  
Houston, Tex.
- Read-More News**  
Minneapolis, Minn.
- RFI Electronics**  
Ft. Worth, Tex.
- Reitz Electronics**  
Toledo, Ohio
- Road Runner Computer Products**  
Glendale, Ariz.
- Robbins Electronics**  
Durand, Mich.
- John Rollins**  
Kalamazoo, Mich.
- Sail of the Earth**  
Albuquerque, N.M.
- Sandmeyer's Bookstore**  
Chicago, Ill.
- Harry Schwartz Bookshop**  
Milwaukee, Wisc.
- Sewing Center**  
Orlando, Fla.
- Soenen & Wilmoth Books**  
Clearwater, Fla.
- Soft Sector Marketing**  
Garden City, Mich.
- Software Access**  
Irving, Tex.
- Software 'n' Suds**  
E. Windsor, N.J.
- Soft Shop**  
Yuma, Ariz.
- Software Centre**  
Torrance, Calif.
- Software City**  
Fairview, N.J.
- Midland Park, N.J.**
- Manhale, N.J.**
- Pinebrook, N.J.**
- River Edge, N.J.**
- Summit, N.J.**
- Technek, N.J.**
- Software Concepts**  
Dallas, Tex.
- Software Connection**  
Ft. Lauderdale, Fla.
- Software, Etc.**  
Houston, Tex.
- Software 1st**  
Santa Rosa, Calif.
- Software Plus**  
Citrus Heights, Calif.
- Software Shop**  
Mansfield, Mass.
- Software Station**  
Rockaway, N.J.
- Software Store**  
Tampa, Fla.
- The Software Store**  
Rockville, Md.
- Software Unlimited**  
Tucson, Ariz.
- Software Unlimited**  
Orlando, Fla.
- Sound Trader & Computer Center**  
Tampa, Fla.
- Sound Video Ltd.**  
Niles, Ill.
- Spectrum Projects**  
Woodhaven, N.Y.
- Sterling Book Center**  
Sterling Heights, Mich.
- Stevens Radio Shack**  
Phoenixville, Pa.
- Strawflower Electronics**  
Jaffa, Milwaukee, Calif.
- Tobacco Corner Newsroom**  
Memphis, Tenn.
- T. M. Computers**  
Kingstons, Ont.
- Total Circulation Services**  
New York, N.Y.
- Trade 'N' Books**  
Montgomery, Ala.
- Tri-Count Electronic Radio Shack**  
Fenton, Mich.
- Tri-Tek Computers**  
Phoenix, Ariz.
- Unilex Software**  
Crown Point, Ind.
- Unicorn Electronics**  
Johnson City, N.Y.
- University of Chicago Bookstore**  
Chicago, Ill.
- University of Illinois Bookstore**  
Chicago, Ill.
- University of Wisconsin Bookstore**  
Milwaukee, Wisc.
- Videomat, Inc.**  
Chicago, Ill.
- Village Green**  
Rochester, N.Y.
- Village Computer & Software**  
Cedar Knolls, N.J.
- Wayne Software**  
Wayne, N.J.
- Wholelife Dist.**  
Denver, Colo.
- Willy's Electronics**  
National City, Calif.

# RAINBOWfest

Regency-Hyatt Woodfield

Chicago

April 22-24



# ADVERTISER'S INDEX

We encourage you to patronize our advertisers—all of whom support the TRS-80 Color and TDP System-100 computers. We will appreciate your mentioning the RAINBOW when you contact these firms.

Aardvark 80.....	195	DSL Computer Products.....	129	PCLEAR 80.....	182
A5 Magazine.....	116	Dugger's Growing Systems....	54	Peacock Enterprises.....	124
All American Ultra-Light Industry.....	62	Dymax.....	137	B.T. Pearce.....	130
All Color Software.....	200	Dynamic Electronics.....	114	Petrocci Freelance Associates .....	46
A. M. Hearn Software.....	216	80-U.S. Journal.....	221	Platinum Software.....	131
American Library & Info Services .....	80	Elite Software.....	11	Prickly-Pear Software .....	35, 38, 75, 99
Anteco.....	9	Emerald Computer Service... ..	108	Prism Software.....	16
Arizin.....	215	Endicott Software.....	213	Programs By Mr. Bob.....	66
Ark Royal Games.....	155	Erickson, B.....	128, 162	The Program Store.....	171
Armadillo International.....	222	Federal Hill Software.....	120	The Programmer's Guild..	101, 207
Aurora Software.....	98	General Automation.....	97	The Programmer's Institute..	185
Basic Programs.....	113	Genesis Software.....	50	Pyramid Distributors.....	31, 142
Basic Technology.....	224	Great X•P•T.....	173	Q-Soft.....	86
Bear Bones Software.....	90	Greentree Software.....	130	Q Systems.....	58
Bertamax.....	53	Harmonycs.....	204	Quasar Animations.....	179
Better Software.....	212	HIB Software.....	148	Radio Shack.....	37
B5 Software.....	41	Home Base Systems.....	92	Rainbow Connection Software .....	175
Botek Instruments.....	109	Home Run Software.....	87	RAINBOWfest.....	111
Boudoir Software.....	110	F & T Software.....	197	Rainbow On Tape.....	174
Bruck Associates.....	192	Frank Hogg Laboratory..	21, 22, 23	Real Software.....	176
Bumblebee Software.....	205	Illustrated Memory Banks.....	135	S & S Arcade.....	91
Calc-Soft.....	13	Ilume Design.....	49	SDS Computers.....	166
Cer-Comp.....	47	Intellectronics.....	25	Selected Software.....	107
Chattanooga Choo-Choo Software .....	208	Inter+Action.....	203, 214	Shauntronics.....	193
Chromasette.....	55	International Software.....	143	Silver Spring Software.....	19
Circle City Software.....	189	Intracolor.....	85	Snake Mountain Software....	147
Classical Computing.....	170	International Color Computer Club.....	163	Soft City.....	77
CoCoData Enterprises.....	112	JARB Software.....	151, 187	Soft Sector Marketing.....	15
CoCo Hut.....	36	JMN.....	52	Software Options.....	104
CoCo Pro.....	60	JPC.....	82	Software Shop.....	96
CoCo Warehouse.....	79	Kalglo Electronics.....	134	Softwride.....	81
Cognitec.....	159	K&K Computerware.....	183	Southco Sales.....	59
Color Computer Weekly.....	142	KRT Software.....	51	Southern Software.....	145
Color Software Services .....	17, 103, 220	Land Systems.....	191	Spectral Associates.....	45, BC
Color Soft Software.....	172	Mark Data Products..	127, 138, IBC	Spectrum Projects .....	115, 117, 118, 119, 121, 123, 125
Comp-U-Kids.....	190	Mars Software.....	48	Speech Systems.....	205
Compukit.....	39	Martin Consulting.....	150	Star-Kits.....	83
Computer Accessories of Arizona.....	217	Marymac Industries.....	153	Hoyt Stearns Electronics.....	76
Computer Island.....	219	Med Systems Software.....	157	Strictly Color.....	57
Computer Plus.....	3	Micro-80.....	178, 186	Sugar Software.....	105
Computer Shack .....	67, 69, 71, 73, 156, 188	Micrologic.....	68	Superior Graphic Software....	93
Computerware.....	61	Micronix.....	133	Superior Oracle Software.....	146
Custom Software Engineering .....	169	Micro Product Division.....	14	Tabby Enterprises.....	196
Data-Comp.....	199, 223	Micro Technical Products....	165	TASADA.....	161
Dataman.....	43	The Micro Works.....	139	T&D Software.....	149
Debug.....	201	Tom Mix Software .....	29, 141, 210, IFC	Transformation Technologies..	202
Delker Electronics.....	33	Moreton Bay Laboratory....	42, 44	Universal Data Research Inc.....	72
Desert Software.....	140	Moses Engineering.....	194	Washington Computer Services .....	181
Double Density Software.....	63	Nanos Systems Corp.....	177	York-10.....	167
		Nelson Software Systems .....	26, 27, 88, 89	Zeta Software.....	95
		Oelrich Publications.....	32		
		Owl-Ware.....	30		
		Parsons Software.....	106		



# COLOR COMPUTER ACTION GAMES

FAST / EFFICIENT / MACHINE LANGUAGE

## COLOR

# HAYWIRE

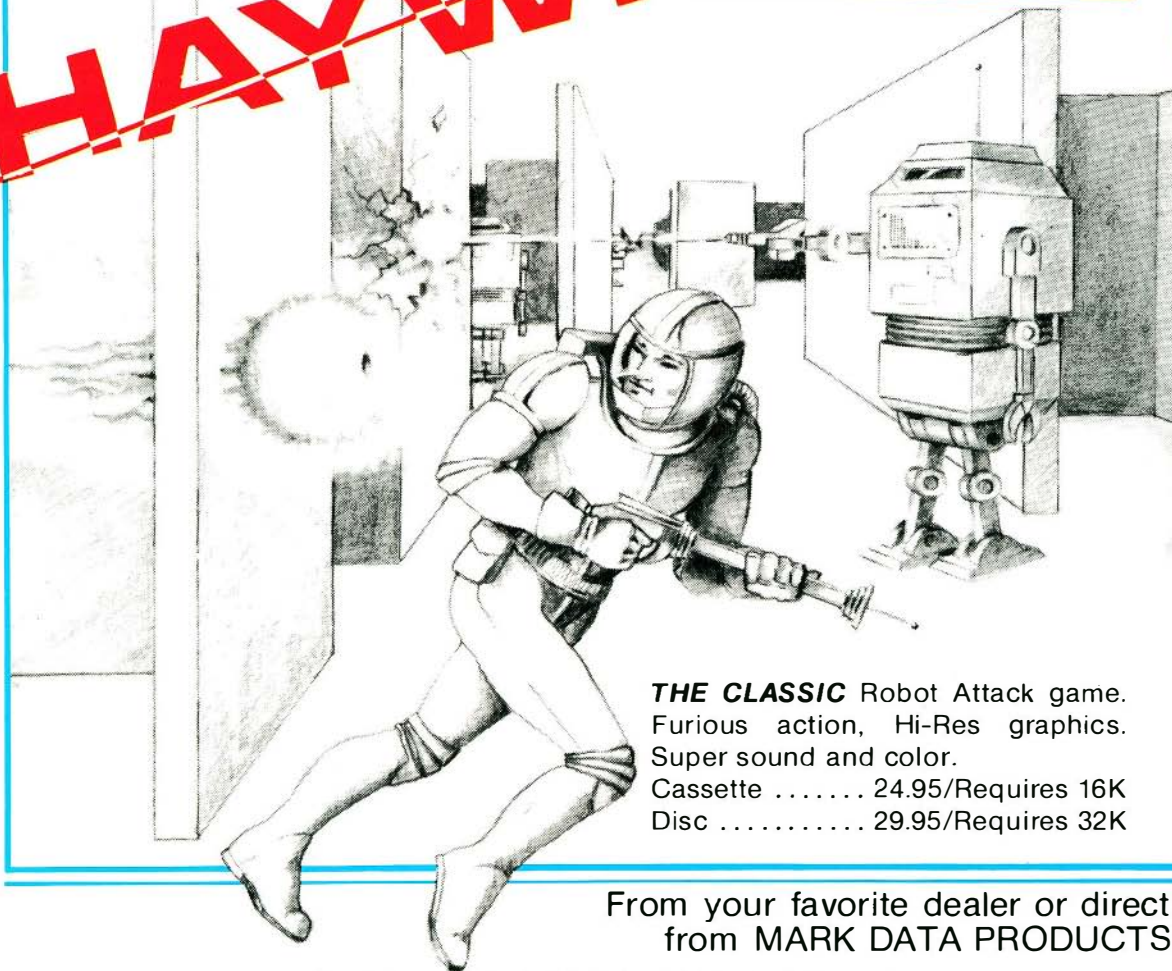

**THE CLASSIC** Robot Attack game.  
Furious action, Hi-Res graphics.  
Super sound and color.  
Cassette ..... 24.95/Requires 16K  
Disc ..... 29.95/Requires 32K

From your favorite dealer or direct  
from MARK DATA PRODUCTS.

## OTHER GAMES AVAILABLE

**ARCADE GAMES:** SPACE RAIDERS / ASTRO BLAST / CAVE HUNTER

CASSETTES: 24.95 Requires 16K / DISCS: 29.95 Requires 32K

**ADVENTURE GAMES:** CALIXTO ISLAND / THE BLACK SANCTUM

CASSETTE VERSION: 19.95 each

**SEND FOR OUR FREE FLYER**



## Mark Data Products

24001 ALICIA PKWY., NO. 226, MISSION VIEJO, CA 92691 • (714) 768-1551

We pay shipping on all orders in the continental U.S. and Canada. Overseas add \$3.00. California residents, please add 6% sales tax. We accept MasterCard and VISA. We are always looking for quality machine language programs. Contact us for details.



# SPECTRAL ASSOCIATES

16K Arcade Quality Games  
For TRS-80 Color Computer

Only  
\$21.95

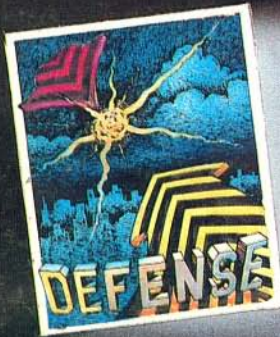

SPECTRAL ASSOCIATES, 141 HARVARD AVE., TACOMA, WA. 98466

**BEST SELECTION ANYWHERE**

GREAT UTILITIES

FLEX+ DOS

BEST EDITOR/ASSEMBLER

SUPER MACHINE LANGUAGE GAMES

FANTASTIC BASIC GAMES

BOOKS

TOLL FREE FOR ORDERS ONLY: **1-800-426-1830** 8:30-4:30 P.S.T.

Except WA, AK, HI

**BUSINESS OFFICE: 206-565-8483**

We accept VISA, MASTERCARD, AMERICAN EXPRESS.

Add 3% for shipping, NO C.O.D. All prices U.S. FUNDS.

**To find out about our other products, write or call for catalog.**