

OS-9 Newsletter[®]

Volume V Issue 4

Bellingham OS-9 Users Forum

April 30, 1994

Latest High Speed Computers run OS-9

Heurikon Corporation has just introduced their Nitro 68040 and 68060 VMEbus CPU boards. They feature an optimized VME64 system-bus interface, an 80 megabyte/s Corebus mezzanine (local-bus) interface, on-board Ethernet and SCSI-2 interfaces with direct memory access and two high-speed serial ports. 8 or 16 megabytes of 70-ns DRAM, 4 megabytes of flash memory for applications storage, 512 kilobytes of ROM, and 2 kilobytes of nonvolatile RAM.

The Motorola 68040 and 68060 chips are built with a clock-doubling technique. They run at an internal clock rate twice as fast as their external speed. The 68060 has a peak performance of 100 MIPS (million instructions per second) with an external clock (I/O speed) of 25MHz. The chips contain an 8 kilobyte instruction cache, an 8 kilobyte data cache and a 256-entry branch cache.

To speed memory accesses, the chips DRAM employs a two-way bank-interleaved architecture with write-posting buffers. This architecture enables the main-memory subsystem to support burst-mode write operations with no wait states. Data movement and I/O operations are expedited by the DMA-intensive architecture that encompasses the high-speed system bus, as well as the Ethernet, serial, and mezzanine-bus interfaces. The VME64 interface, which is based on the standard Cypress VIC64 VME interface chip, employs FIFO buffers to decouple the local bus and VMEbus. As a result, both buses can run simultaneously at their maximum speeds.

The Nitro CPU boards are designed for graphics oriented applications that require high-speed I/O and data transfers. Software support for the Nitros boards includes two real-time operating systems: **VxWorks** developed by Wind River Systems Inc., Alameda, California; and **OS-9** from Microware Systems Corp., Des Moines, Iowa.

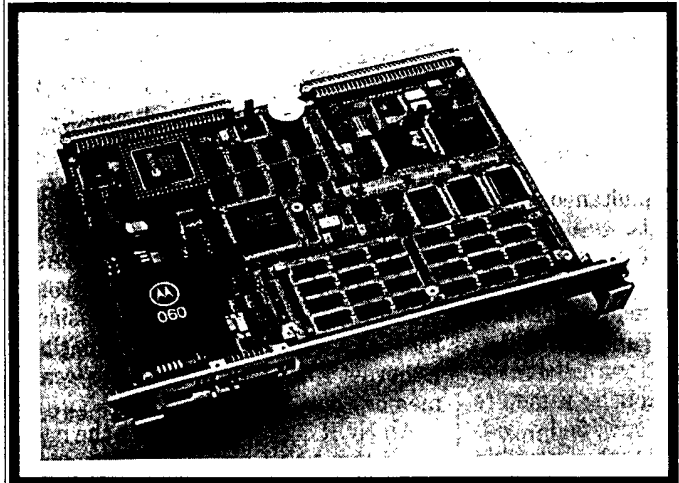

Heurikon's Nitro60

Features a VME64 interface, 80-Mbyte's Corebus mezzanine bus, on-board Ethernet and SCSI 2 interfaces and two high-speed serial ports. It also holds 8 or 16 Mbytes of 70-ns DRAM, 4 Mbytes of flash memory, 512 kbytes of ROM, and 2 kbytes of nonvolatile RAM.

*** IN THIS ISSUE ***

Newest High Speed OS-9 Computers Heurikon's Nitro40 & Nitro60 CPU Boards	Pg. 1
Questions & Answers Do All Archive Utility, Proper use of XMOIDE, Shell+ Bug?	Pg. 2
CoCo to PC Case Installation Step by step instructions with wiring diagrams	Pg. 3
Third LAST CoCoFEST Latest listing of speakers and vendors	Pg. 9
Puppo CoCo/PC Keyboard Interface Corrections to Schematic diagram	Pg. 9
Club Activities Report Port O'CoCo and Seattle 68xxxMUG "PNW CoCoFEST is a Go"	Pg. 10

Q&A

Q: I remember some time ago asking if there was an automatic archive conversion utility that could convert any archive to any type automatically. On My old ibm when I had one, I used to use a tool called *zzap*. It converted archives based on the information that I provided in a file called *zzap.dat*. Meaning if an archiver existed for a specific extension, it

would know what to do with it. I used to use this program automatically when my BBS was running on my XT to automatically convert archives on the fly as an event. I use LHA 2.11 both on my IBM and the Coco 3. Since I no longer have an IBM compatible. I no longer have *ZZAP*.

I would Kill for a *ZZAP* processor system for my coco! I am phasing out AR and guess what? I have to process over 5,000 .AR files! Now if there was a time I needed a robot batch file converter system.... It is now! Will one of you great hackers create one?

==Michele Marie Dalene==
Delphi, OS-9 Forum

A: Actually, Michele, there is a package under OS-9 which, I think, will almost do what you want. I THINK it's called *archiveutil*. It was available from OCN libraries.

==Bob Devries==
@paxnet.com.au
Australian National OS9 Usergroup|

Q: Under OS9 68020 v2.4, when I xmode any of the terminal descriptors (to change the baud rate) the CRC is no updated... What's the deal? I find it hard to believe Microware would have not caught that, was it maybe done for a purpose? If not, is there a replacement xmode that does update the CRC's?

==Timothy Johns==
@atanasoff.sfasu.edu

A: Make sure you deiniz before your xmode, then iniz for the new settings to take effect...

```
deiniz /t1
xmode /t1 baud=9600
shell -l <>>/t1&
```

==Tony==

Q: I am running *Shell+* on my CoCo-3 with Kevin Darling's keyboard buffer enhancement so that I press [Shift]+[Right Arrow] instead of [CTRL]+[A] to display the last keyboard entry. However, sometimes this feature is completely dead until I reboot the computer. Does anyone know the problem or the solution?

==Anonymous==

A: What has happened is that somewhere along the line you have enabled the keyboard mouse function which is done by pressing the combination of [CTRL]+[CLEAR] keys. Simply press this key combination again to restore you enhanced SCF editor functions.

==Rodger Alexander==

OS-9 Newsletter

Editor: Rodger Alexander

OS-9 Newsletter is published monthly by the **Bellingham OS-9 Users Forum** and is protected under United States Copyright Laws. No material may be reproduced or copied in whole or in part without the expressed written permission of the Bellingham OS-9 Users Forum, 3404 Illinois Lane, Bellingham WA 98226

Submissions are welcomed in any format and can be mailed to the above address or sent via electronic mail to the editor: Rodger Alexander, on Delphi (UserID: SALZARD) or FidoNET (1:301/3401@fidonet.org) or Internet (ralexander@nikita.bham.wednet.edu). Unfortunately, we do not have funds to reimburse authors of selected articles. However, a complimentary copy of the *OS-9 Newsletter* containing your article will be mailed to you, PLUS the satisfaction that you will have the admiration and appreciation of all of our readers.

The *Bellingham OS-9 Users Forum* is a hobbyist club, organized for the purpose of providing information, services, products and events that support the OS-9 operating system for 6809/68xxx based computers. Our efforts are not intended to earn or generate any profit for the club or any of it's members.

TO SUBSCRIBE

For 12 monthly issues of the *OS-9 Newsletter*, please send a US check or money order for \$12 or \$7 for a 6 month subscription. Mail your subscription order to:
OS-9 Newsletter
3404 Illinois Lane
Bellingham, WA 98226

Include your name, address and telephone number. You will receive your *OS-9 Newsletter* no later than the 10th of each month. Canadian orders, \$13.50 for 1 yr. or \$7.60 for 6 mo. Foreign orders \$18 for 1 yr. or \$10 for 6 mo.

CoCo to PC-Case Installation

by Rodger Alexander

DISCLAIMER:

The installation of your color computer into a PC type case may require minor or major modification to your color computer hardware. It is understood that any modification voids all warranties and may result to inadvertent damage to components and/or circuit traces on the circuit boards. Every effort should be made to limit board modifications. All modifications to the circuit boards in this text are restricted to only those necessary to permit installation into appropriate PC cases.

TOOLS:

1. Electric Drill (Drilling mounting holes in PC Case)
2. Hack Saw (For cutting older style Multipak Circuit Board)
3. Soldering Iron (15-25 watt) and fine electronic solder
4. Screwdrivers (small-medium straight edge and phillips)
5. Wire cutter (stripper)
6. Needle nose pliers or surgical forceps
7. File to reduce thickness of rom-pak card edge
8. Vise to press on solderless connectors

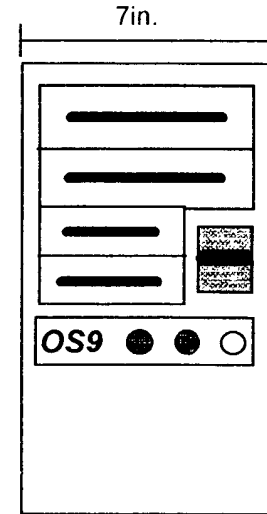
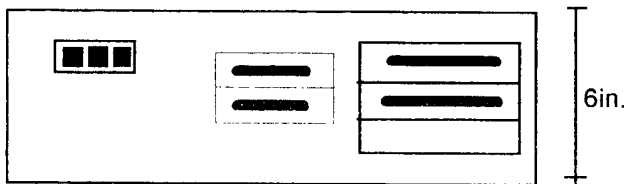

NOTE: *Minimum height/width required is 6 inches to accommodate the width of the Color Computer and multipak circuit boards.*

PARTS:

1. Mini or Midi Tower or standard horizontal AT IBM clone PC Case
2. Multipak Interface (Preferably the newer/smaller model) OR the Disto 3-in-1 or 4-in-1 board OR one of the more recent multipak replacements now on the market.
3. Color Computer-3.

NOTE: *It is assumed this will be for OS-9 Operation. Rom-Pak's will not be easily accessible in this installation. Also, the slot select switch will be permanently fixed at slot 4 although you could design a front panel switch on your own.*

4. "S-Cable" made up of 3 to 6 inches of 40 conductor ribbon cable and a male and female "KEL-AM" connectors. (Special connectors are available from Terry Laraway, *Small GrafX Ect.* (See Add). Standard female card edge connectors will not work!.)
5. Disk Controller and associated Disk Drives
- *6. Hard Drive Interface and Controller and associated Hard Drive IF you plan to use a Hard drive....this can be installed at a later date.
- *7. Hi-Res Joystick Interface (If desired)
- *8. Printer Interface (Serial to Parallel) if you want a parallel printer port output from the case, otherwise you will have a serial printer port.
- *9. "Y-extension power cable". (This may be needed if you have more than 3 drives.)
10. 6 - 4/40 x 2inch bolts and nuts for mounting circuit boards
11. 4ft. of 4 conductor (22 gauge) wire (Radio Shack Cat# 278-858)
12. 4 pin amphenol jack and plug (Radio Shack Cat# 274-224 & 274-234)

Continued on page 4

I/O Port Options:

13. D-sub type chassis mounted jacks (may be supplied with case) 2 - 9 pin male solder type (Radio Shack Cat.# 276-1537) and 2 - 25 pin male solder type (RadioShack Cat# 276-1547)

NOTE: You may wish to use a 5-pin chassis mounted DIN connector instead of one of the 25-p Dsubconnector for the printer port and a 6-pin DIN connector instead of one of the 9-pin D-sub connector for the joystick port. See step 15 and 16 in the PROCEDURE section for more information.

14. D-sub type IDC female connectors: 2 - 25 pin (Radio Shack Cat# 276-1565) and 2 - 9 pin (not available from Radio Shack)
15. 2 - RCA type 1/4 inch panel mount jacks (Radio Shack Cat# 274-346)
- *16. 1 - 36 position Male Printer (Centronics) solderless connector (Radio Shack Cat# 276-1533)
[Note: See #8 above]
17. 4 - 6 feet of 34 conductor ribbon cable (Keyboard extension Kit)
18. 4 - 6 feet of 25 conductor ribbon cable (Misc. I/O extension)
19. 1 - 2 feet of 10 conductor ribbon cable (Joystick I/O extension)
- *20. 4 - 6 feet of 9 conductor ribbon cable (RGB Monitor extension)
- *21. 1 - 10-pin solderless (IDC type) female header for the RGB terminal on the computer circuit board.
- *22. 1 - 10-pin male chassi mount header connector for RGB monitor.

Keyboard Extension Kit:

23. 1 - discarded rom-pack circuit board **OR** 1 - 1 inch length of 17 conductor single sided (34 conductor double sided) circuit board. (Conductors width and spacing must match the keyboard jack on the CoCo-3 motherboard.)
24. 1 - 34 pin card edge (IDC type) connector (Radio Shack Cat.# 276-1533).

* = Optional parts. See procedures below.

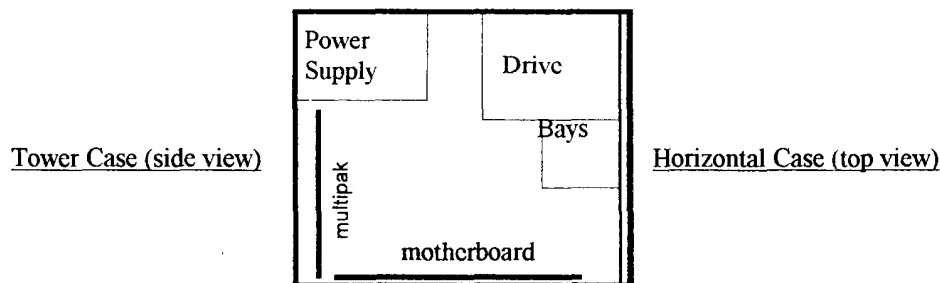
**PROCEDURE:**

- Determine desired orientation of computer and multipak circuit boards (See pictorial diagrams)
- Remove the Voltage regulator IC and the associated heat sink from the multipak circuit board and the Color Computer-3.
- It may be necessary to cut off the end of the reset switch on the Color Computer-3 that extends beyond the edge of the circuit board, also the power switch on both the Color Computer-3 and the Multipak **IF** the switches extend beyond the dimensions of the PC Case. The power switches no longer function anyway, and the reset lines will be wired to the reset switch on the front panel of the PC Case.
- IF USING THE OLDER LARGER MULTIPAK:** Remove the slot select switch and resistors R-1 & R-2. Cut off 3/4 inch from the bottom side, 2-1/4 inch on the right side (power supply components) (See next month's installment)

DANGER: Excessive flexing of the circuit board and vibration may cause damage to solder joints, circuit traces and integrated circuit components.

- IF USING THE OLDER LARGER MULTIPAK:** Solder a jumper to the appropriate slot select trace lines to achieve the same logic function accomplished by the slot select switch when positioned for slot-4. (See next month's installment)
 - Use circuit board templates to determine the location of mounting holes to be drilled through the chassis of the PC case. Drill mounting holes with appropriate size drill bit to match the size of your mounting bolts.
 - Assemble an "S-Cable" using the *KEL-AM* connectors and approximately 2 to 4 inches of 40 conductor cable.
- WARNING:** You cannot use standard card edge connectors. *KEL-AM* connectors are available from *Small GrafX Etc.*
- Mount Disk Drives (and Hard Drive) with hardware screws from their original mountings.

-
10. **CONNECTING PC POWER SUPPLY:** Solder approximately 1 foot of hook up wire to the +12 vdc, -12 vdc, +5 vdc and Ground traces on the multipak, and the Color Computer circuit board. 12. Solder a short length of wire from the +12 vdc connection on the Color Computer to the +8 vdc regulator on the Color Computer circuit board. (See pages 6, 7 & 8, Fig. 1, 2, 3, 4 & 5)
 13. Determine which of the 6-pin connectors from the PC Power Supply contains the following potentials: +12, -12, +5 and Ground. Cut off the original connector and replace with either the male or female 4-pin amphenol connector. (Fig. 4&5)
 14. Solder the wires in step 10 above to the appropriate connections on the remaining 4-pin amphenol connector.
 15. **IF YOU ARE NOT GOING TO MOUNT YOUR PRINTER INTERFACE IN THE COMPUTER:** Solder approximately 1 foot of wire to each of the corresponding trace lines on the bottom of the computer circuit board directly below the printer I/O jack. Solder the other end of each wire to one of the 25-pin D-sub chassis mounted jacks. Press fit (with a vise) 4 to 6 feet of 25 conductor ribbon cable to the 25-pin D-sub solderless connector. Solder the 5 corresponding conductors to your serial/parallel interface. (You may choose to use a 5-pin chassis mounted DIN connector instead of the 25-pin D-sub connector.)
IF YOU ARE GOING TO MOUNT YOUR PRINTER INTERFACE IN THE COMPUTER: Solder approximately 1 foot of wire to each of the corresponding trace lines on the bottom of the computer circuit board directly below the printer I/O jack. Solder the other end of each wire to the correct input line on the serial/parallel interface. Solder the parallel output lines to one of the 25-pin D-sub chassis mounted jacks observing the correct pin numbers to correspond to the centronics printer connector. Press fit (with a vise) the 36 pin centronics connector to 4 - 6 feet of 36 conductor ribbon cable. At the other end, trim conductors 26-36 and press on (with a vise) the solderless D-sub 25-pin connector. Mount the interface in an appropriate location. If you want to have access to the baud switch, you might consider mounting the interface to the chassis with a switch extension shaft extending through the front of the case.
 16. **IF YOU ARE GOING TO USE THE HI-RES JOYSTICK INTERFACE:** Solder approximately 1 foot of wire to each of the corresponding trace lines on the bottom of the computer circuit board directly below the cassette port and one of the joystick ports. Solder the other end to the appropriate connections on the Hi-Res Joystick Interface circuit board. Solder approximately 2 feet of wire to the output a 6-pin DIN jack plugged into the interface circuit board. Solder the other end of each wire to one of the 9-pin D-sub chassis mounted jacks. (You may choose to use a 6-pin DIN chassis mounted jack instead of the D-sub jack.) (See next month's installment for relay operation of hi-res interface)
IF YOU ARE NOT GOING TO USE THE JOYSTICK INTERFACE: Solder approximately 1 - 2 feet of wire to each of the corresponding trace lines on the bottom of the computer circuit board directly below the joystick ports. Solder the other end of each wire to one of the 9-pin D-sub chassis mounted jacks. (You may choose to use a 6-pin DIN chassis mounted jack instead of the D-sub jack.)
 17. **COMPOSITE MONITOR:** Solder approximately 1 foot of shielded wire to the appropriate circuit trace lines on the bottom of the computer circuit board directly below the composite video I/O jack. Solder the other end of each wire to one of the 1/4 inch panel mounted RCA type jacks. Be sure the grounded conductor is connected to the grounded terminal on the jack.
 18. **AUDIO I/O:** Solder approximately 1 foot of shielded wire to the appropriate circuit trace lines on the bottom of the computer circuit board directly below the audio I/O jack. Solder the other end of each wire to one of the 1/4 inch panel mounted RCA type jacks. Be sure the grounded conductor is connected to the grounded terminal on the jack.
 19. **RGB MONITOR:** Press on the 10-pin solderless header connector to approximately 1 foot of 10 conductor ribbon cable. Solder the other end of the cable to a 10 pin male chassis mount header jack on the rear of the case. Check continuity to make sure the pin-outs on the back of the case match the pin-outs on the CoCo motherboard.
 20. **IF YOU ARE USING A MAGNAVOX MONITOR:** Press on (with a vise) a solderless female 10 pin header to 4 feet of 10 conductor ribbon cable. At the other end solder a 6-pin male DIN connector. Check continuity to make sure input and output lines match.
IF YOU ARE USING A TANDY CM-8 MONITOR: Press on (with a vise) a solderless female 10 pin header to 4 feet of 10 conductor ribbon cable. At the other end, press on (with a vise) a solderless 10 pin male header connector. Check continuity to make sure input and output lines match.
 21. Connect the multipak and the color computer circuit boards together via the short "S-Cable" and mount the two circuit boards into the PC chassis. Use the shielded backings on the circuit boards as templates to provide accurate locations for drill holes in the PC Chassi. Re-attach the shielded backings before mounting the circuit boards with the 2 inch 4/40 bolts. Use extra nuts to provide desired mounting height.
 22. Do a continuity test between the different voltage trace lines and the amphenol connectors. Connect disk drive power connectors to disk drive(s)...Then turn power on and check for proper voltages on both circuit boards. If no voltage is present then there is a short and the PC power supply will automatically shut off.

NOTE: *It is very important that the disk drives be connected to provide a load for the power supply. The CoCo and Multipak will not provide sufficient load to the power supply. Without sufficient load, the power supply may be damaged. You may want to place a 5 ohm 10watt resistor across the power supply to increase the load.*

23. Plug in your Disk controller and connect to the disk drive(s). Connect monitor to appropriate jack(s).
24. **KEYBOARD EXTENSION KIT** : Cut 1 inch off the end of a discarded rom-pak (preferably Spectaculator). Cut the card edge so that only 16 trace lines will fit into the keyboard jack on the computer circuit board. Then file, sand or grind down one side only until the card edge is the correct thickness to insert firmly into the keyboard jack without forcing or damaging the jack. (See next month's installment)
25. Press on (with a vise) a 34 pin card edge connector (female) on one end of a 4 to 6 ft. length of 34 conductor ribbon cable. Identify one side of the connector as the "Top Side" and at the other end cut the insulation off the 16 conductors that match the "Top Side" pins connectors. (See next month's installment)
26. Solder the 16 wires to the circuit board matching the keyboard conductors with the circuit board conductors.
27. Glue, or otherwise attach a thin piece of cardboard to the back side of the mylar keyboard cable and plug the keyboard into the other 34 pin card edge connector. (See next month's installment)
28. Do a continuity test so that each trace line on the keyboard mylar cable corresponds to the proper pin on the keyboard jack on the computer.

SMOKING TEST:

After all voltage checks and continuity test have been made (with proper results), plug in the keyboard and monitor, then apply power. **Watch for smoke!** If power levels remain constant at the right levels and you get the Color Computer "Disk Extended Basic" screen.....you're lucky! And you have succeeded with your installation! **CONGRATULATIONS! ! ! !**

PC Power Supply Connections

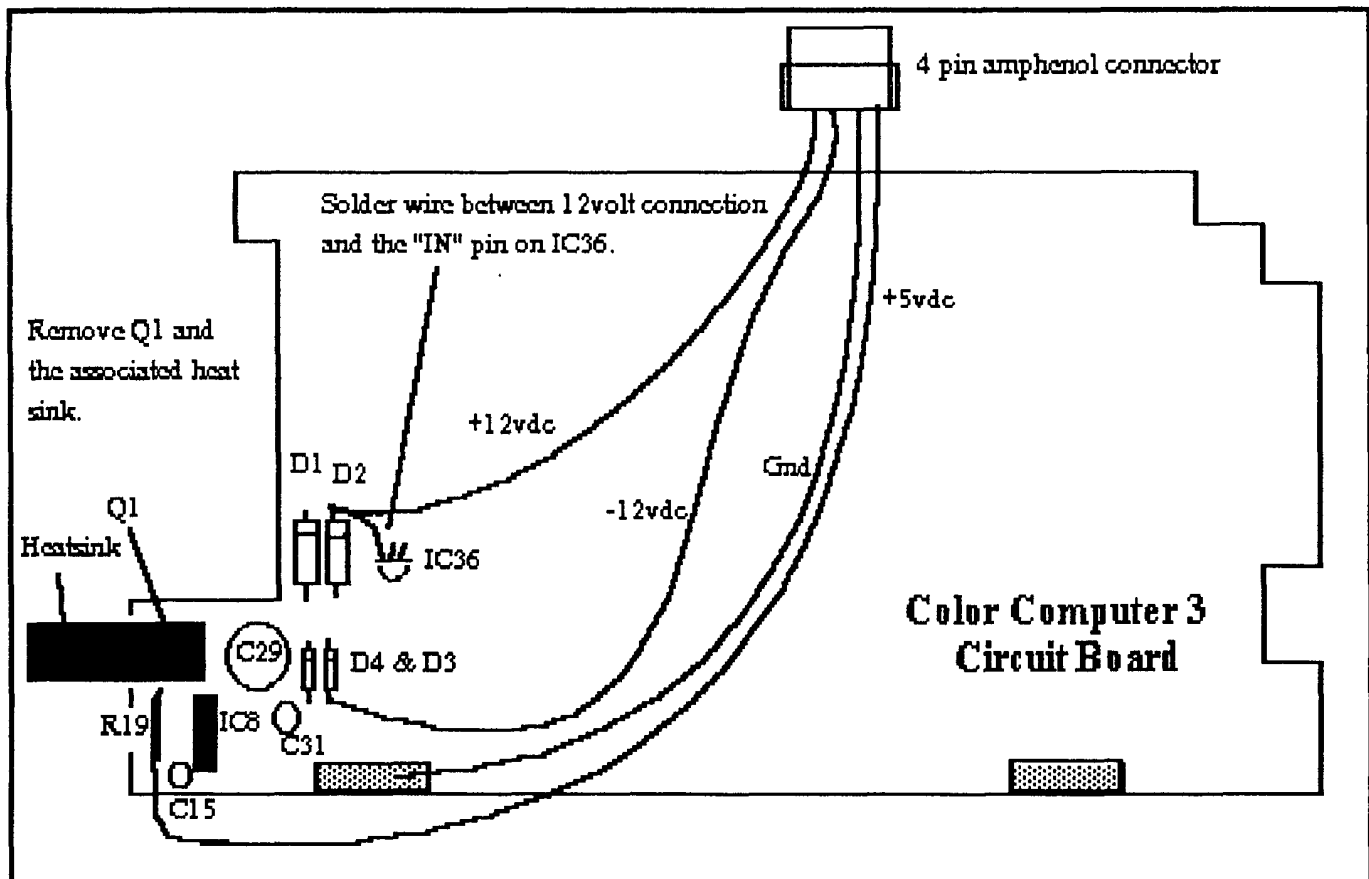

Fig 1.

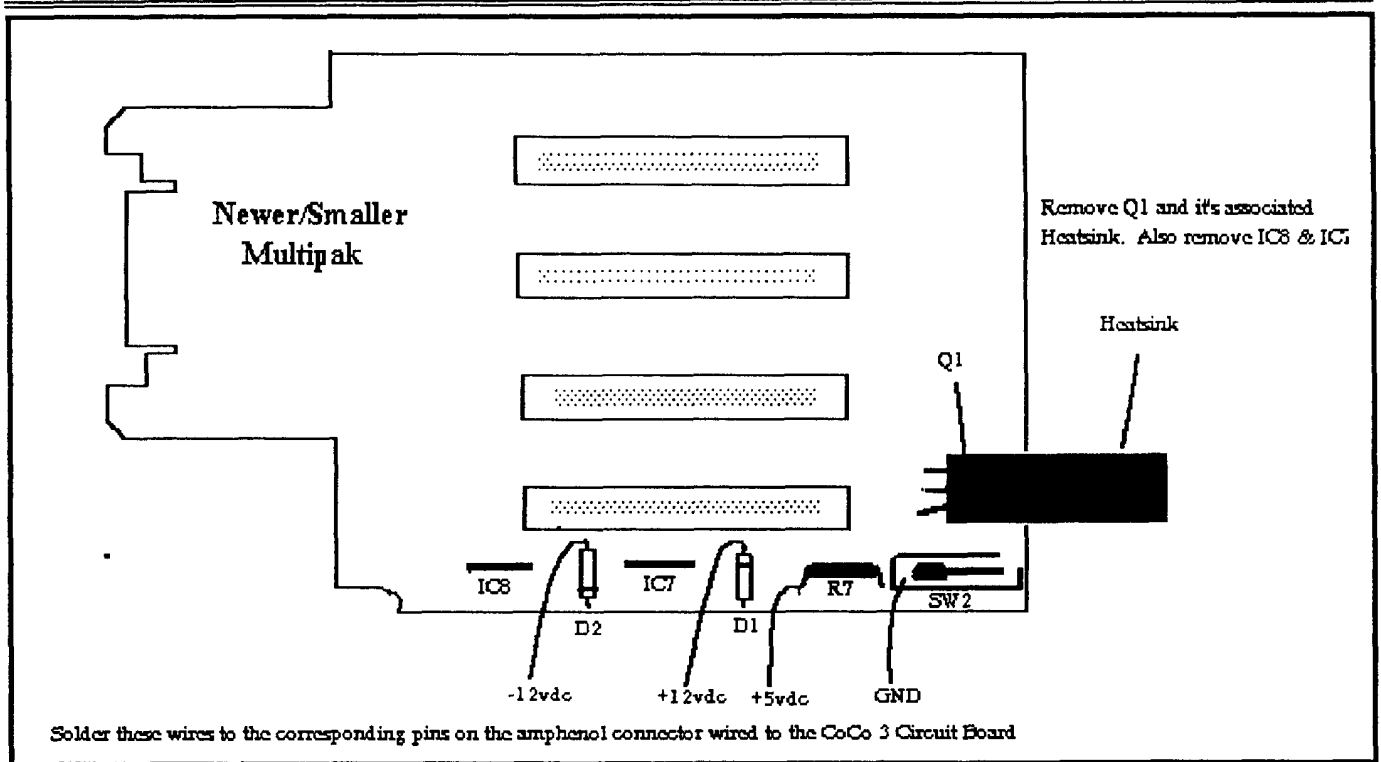

Fig. 2

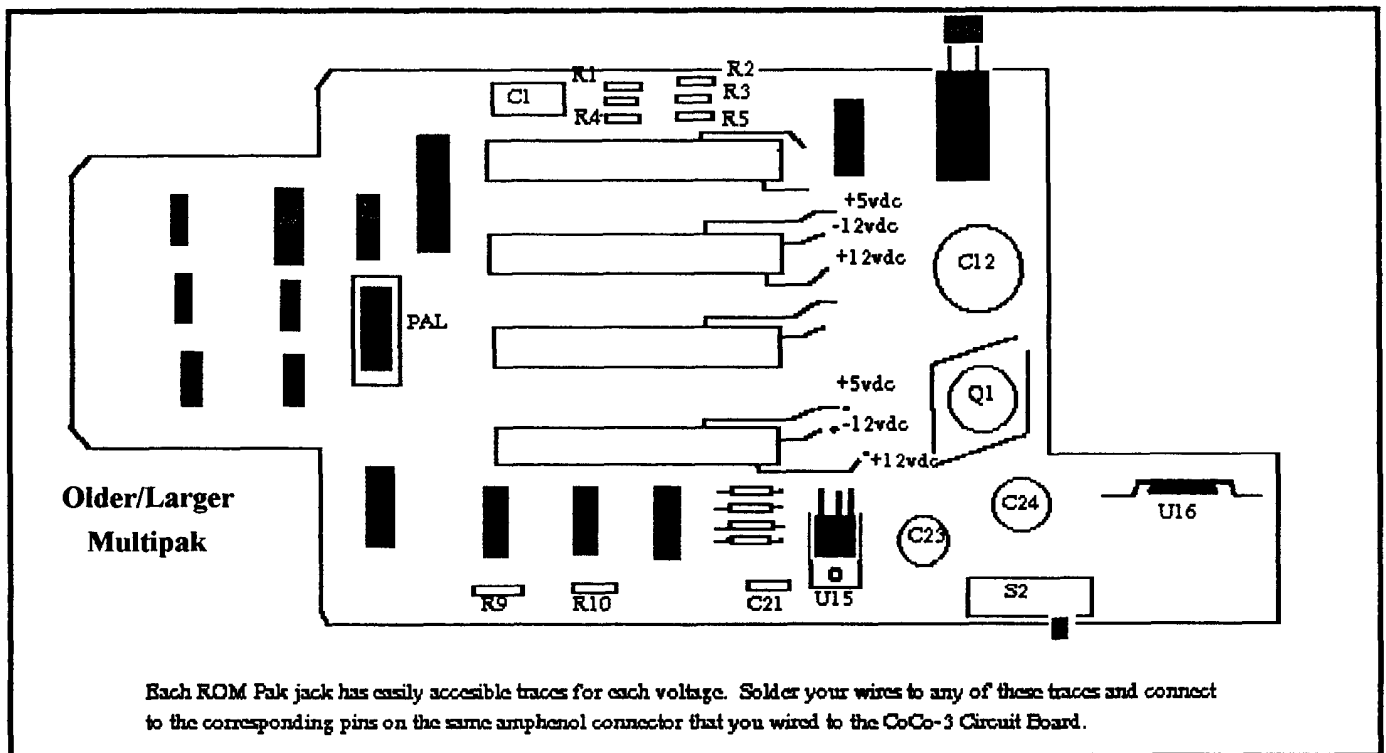

Fig. 3

REGARDLESS OF WHICH MULTIPAK YOU USE, connect the wires to the same amphenol connector that you attached to the CoCo-3 Circuit Board (See Figure 1). Check your work using an ohm meter/continuity checker to be sure that the corresponding voltage lines on both the Multipak and the CoCo-3 are connected to the same pins on the amphenol connector.

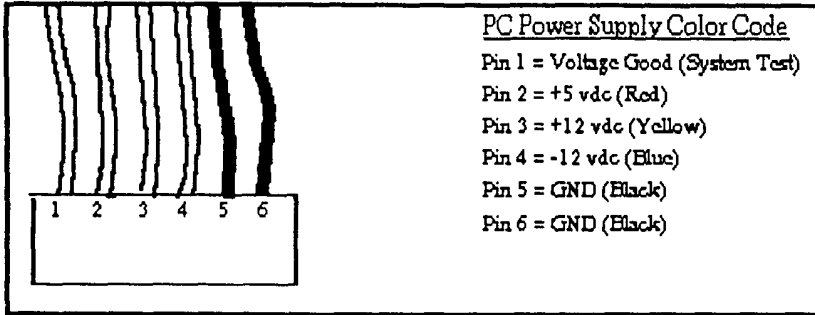

Fig. 4

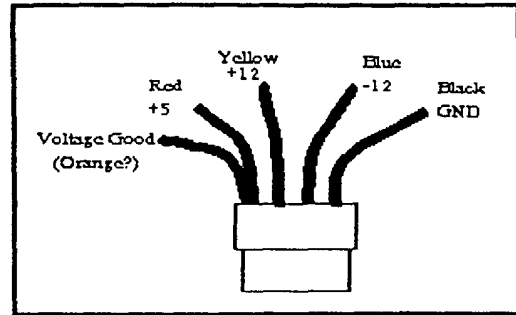

Fig. 5

Your PC Power Supply will have two 6-pin connectors designed to plug into a PC Circuit board. If your power supply is for an AT machine (80286, 80386, 80486) then you will see the above color coded wires on one of the two 6-pin connectors. *The Black ground wires will always be pins 5 & 6.* Cut this connector off and replace with a male 4-pin amphenol connector. Solder the "Voltage Good" wire to the Red wire (5volts) before soldering the Red wire to one of the amphenol pins. If your Power Supply is for an XT machine (8088, 8086) then simply ignore the "Voltage Good" wire. Solder the Black, Blue and Yellow wires to the remaining amphenol pins and insert the pins into the amphenol casing so that they will match the corresponding wires on the female amphenol connector attached to the CoCo/Multipak Circuit Boards.

FINAL POINT: I have specified using D-sub type chassis mounted connectors (jacks) on the back of the PC case. This is because knock-out panels already exist for these specific connectors. However, this requires that you make adaptors for you mouse, joysticks and printer. The 4, 5 and 6 pin DIN connectors would make more sense except for the fact that the steel chassis is very hard to drill and make holes of the proper size unless you have access to a chassis punch set. The decision is yours!

NEXT MONTH:

I will include instructions and diagrams of how to physically "chop" the older/larger Multipak so that it will be small enough to fit into the computer case. In fact it will be about 30% smaller than the new model of the Multipak. Also an article by T. Warren that was printed in the OS-9 Newsletter three years ago that shows how to modify the hi-resolution interface so that it can be switched from "low" to "hi" without unplugging any of the cables. This is done simply by one of the front panel switches on your PC case and a very small relay that fits into the interface. The article even includes schematics for a sensing circuit so that the switching can be done automatically when your graphics software requires the hi-res interface.

KCS Welcomes
Port O' CoCo
 for the Tandy Color Computer
 as a SIG!
7 p.m. 3rd Monday of month
Stock Market Foods, Port Orchard

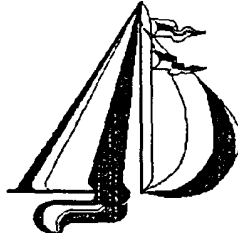

PNW Community Computer Festival IV
June 24 & 25

- Famous Swap Meet!
- Expert Speakers
- Keynote Speech
- Breakfast & Lunch
- Collectable Mug
- Hands-on Demos

Marcus Whitman Jr. High
 Port Orchard
871-6535
 Info & Suggestions

\$20 before June 1st, \$25 at the door
3046 Banner Rd SE, Port Orchard 98366-8810

68K Products
 from
Bob van der Poel Software

Ved/68xxx Text Editor	\$59.95
Update to current version	\$19.95
Vprint/68xxx Text Formatter	\$59.95
Update to current version	\$19.95
Vmail/68xxx Mailing List	\$49.95
Update to current version	\$15.95
Cribbage for Kwindows	\$19.95
Magazine Index System	\$19.95
Disk Catalogue System	FREE with any order

Add \$3.00 for shipping in Canada and USA

P.O. Box 355 Porthill, ID USA 83853-0355 (604) 866-5772	P.O. Box 57 Wynndel, B.C. Canada V0B 2N0 CIS 76510,2203
--	--

3rd LAST Annual CoCo FEST

by Tony Podraza

DATELINE: April 18, 1994

As of this writing, there are twenty-two official exhibitors. They are:

- 1) Barsoft, Dave Barnes
- 2) ColorSystems, Zack Sessions
- 3) DELMAR, Ed Gressick
- 4) Hawksoft, Chris Hawks
- 5) Farna Systems, Frank Swygert
- 6) Crystal Palace BBS, Nelson Howard et al
- 7) DISTO, Tony Distefano
- 8) Budgetware, Brian Kitt
- 9) JWT Enterprises, Jordan Tsvetkoff
- 10) Adventure Survivors, L. E. & Nan Padgett
- 11) The Chicago OS9 User's Group
- 12) The National OS9 User's Group
- 13) StrongWare, John Strong et al
- 14) SBUG, Andre Levalle
- 15) Blackhawk Enterprises, David Graham
- 16) Northern Xposure, Colin McKay et al
- 17) Dirt Cheap Computer Stuff Co., Mark Griffith
- 18) Glenside Color Computer Club of Illinois
- 19) JoTA Productions, Timothy Johns
- 20) Frank Hogg Laboratories, Frank Hogg
- 21) Digigrade Productions, Dave Pellerito
- 22) Ken-Ton Electronics Inc, Joe Scinta

In addition, there have been verbal intentions of attendance by Kala Software, CoNect, Animajik Productions, Sub-Etha, DALTRUG, and one or two others whose names escape me at this time. And the list continues to grow. Time is getting short! Be sure that you are going to be represented at the greatest CoCo/OS9 event of Spring 1994!

Admission: \$15.00 at the door

2-day pass only; sorry, no 1-day passes
 Advance ticket sales: \$10.00 + SASE or \$10.00 + \$.50 postage

Children 5 and under FREE
 Ages 6 - 16 \$5.00 Discount when accompanied by an adult
 Contact: George Schneeweiss, Treasurer
 Glenside Color Computer Club
 RR#2 Box 67
 Forrest, IL 61741-9629

For further information, general or exhibitor, contact:

Tony Podraza, Fest Chairman
 708-428-3576, VOICE
 708-428-0436, BBS

Puppo Update

Last Fall, the schematic diagram of the Puppo CoCo/IBM Keyboard Adapter was published in *The World of 68' Micros*. Unfortunately, the promised circuit board diagram and/or kit did not come about and we have been pondering the possibility of designing our own circuit board. I had come across a very sophisticated public domain circuit board designing program for my PC computer (*very slow 286*) and this would be the perfect challenge.

MISTAKES IN THE SCHEMATIC

While drawing in the lines on the cad portion of the program it became obvious that there was some mislabeling. Pin numbers were incorrectly labeled and there was some confusion regarding the circuit traces to the keyboard connector. The routing program caught some of the

(Continued on page 10)

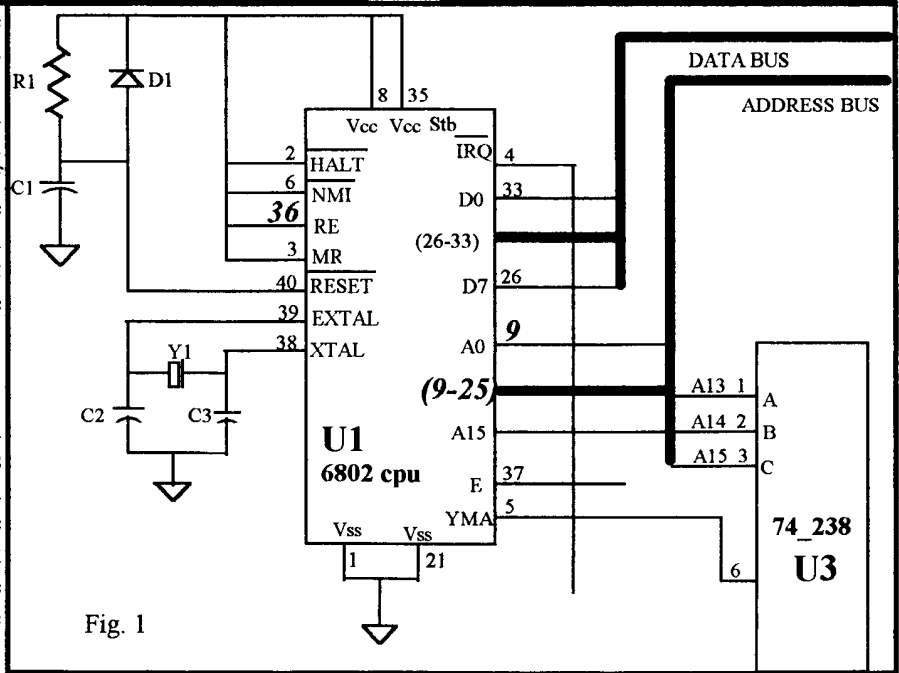

Fig. 1

mistakes and others were so obvious that even I caught them. The most glaring mistake was the mislabeling of D3, since there are only two diodes on the schematic.

In Fig. 1 I have highlighted the mistakes found around the processor section of the schematic diagram. The first error is the mislabeling of pin 36 on the left side of the cpu chip. The second error is the mislabeling of pin 9 on the right side of the cpu chip.

In Fig. 2 I have highlighted pin 16 on U7. This is the B+ or Vcc line on all of the decoder chips so it became quickly obvious that one of the chips was incorrectly marked. The other corrections are more for clarification. Pins 10, 11, and 14 on U6 connect to the same pins on U7. Pins 10, 11, 14 and 15 on U8 connect to the same pins on U9

Nest month I will hopefully have gotten rid of the "Out of Data Lines" error that keeps haunting me and be able to have the complete circuit board diagram ready for the May OS-9 Newsletter.

==Mike Pleas==
Bellingham OS-9 Users Forum

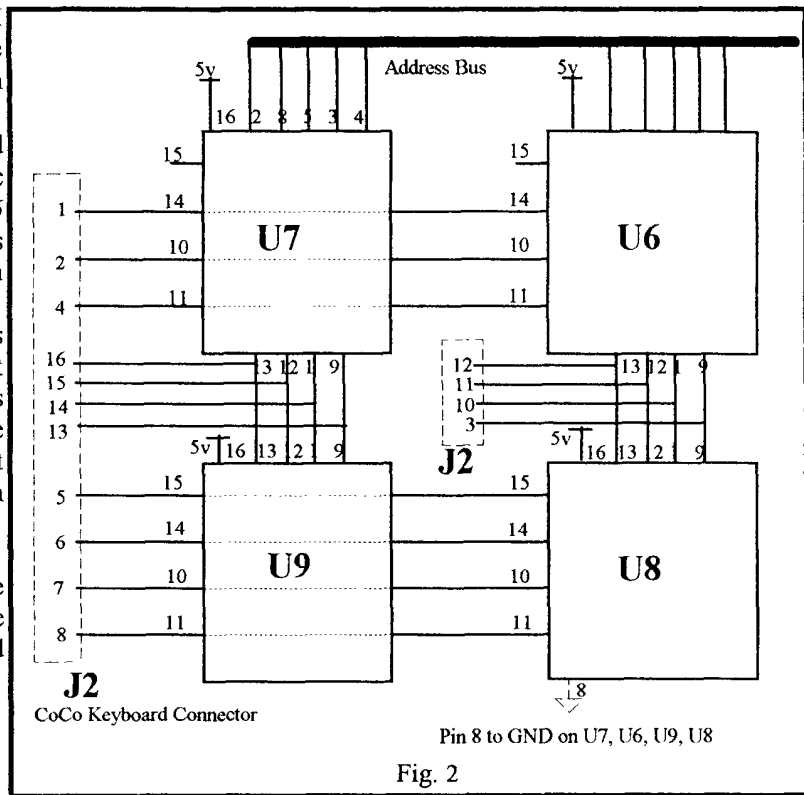

Fig. 2



OS-9 Clubs "Activity Report"

Bellingham OS9 Users Group - Longview/Kelso CoCo Club
Mt. Rainier CoCo Club - Port O'CoCo Club - Seattle 68xxxMug

Port O'CoCo

The April meeting was a double header and the beginning of a new era for at least Port O' CoCo and maybe for the CoCo community in the Pacific Northwest. The first of the double headers was the board meeting of Kitsap Computing Seniors in Silverdale during the afternoon. The purpose of attending this meeting was to propose to the board that Port O' CoCo become part of this larger, well organized and legal, IRS non-profit registered group.

Over the last six months and after several meetings and calls to CPA and the IRS it became apparent that we were either going to spend at least \$300 to become a 501(c)3 non-profit or we were going to toss logic and care to the wind by not bothering to do anything. The third option was to find a similar organization that had already done what had to be done and become part of it. That's where KCS comes in.

The board was kind enough to put our request at the top of the meeting. Buzz Jones gave of his time and participated in the discussion of what this merger would mean. After fully airing the issue, concerns and informational questions, the board

voted to accept our request to allow us to become part, a SIG (special interest group), of KCS.

Part of the agreement is that anyone who has been a part of our organization may join KCS for one year for free when they request to become a member in writing and mail in a special postcard along with their written request. Those card should be in the hands of those who have been involved with Port O' CoCo by now.

Do not feel that you should not take advantage of this offer if you only attended a few meetings! Also, being outside Kitsap County does not disqualify membership. By joining you automatically receive KCS's excellent newsletter with news about all kinds of computing issues. There are advertisers who offer special deals to this LARGE group (at last count 437). So If you are sitting outside Kitsap County and still have an interest in the CoCo and/or computing in general, just take a moment to take advantage of the deal we negotiated. At the end of the year if you have found your interest to be so low that you don't pay the dues yourself, so be it.

Another point to be made clear for those who have put lots of

(Continued on page 11)

(Continued from page 10)

effort into the CoCo community. The funds we have on hand now are not just being given to KCS and that's the end of it. No, those funds are to be used as seed money for the next PNW CoCo FEST! That is, The Pacific Northwest Community Computer Festival IV. It will definitely be bigger and better than anything we have had before. Not only will we have a CoCo FEST going on, but also we will have speakers and presentations designed and conducted by the PC community and probably the Mac and maybe other platforms as well. So mark your calendars for the dates announced last year . . . June 24th (Friday) and 25th (Saturday) for the CoCo event of the year west of the Mississippi!

If you have any hot ideas for the FEST now is the time to voice them so we can consider them. Write, call, anything to get your ideas to us!

The usual meeting at 7 p.m. focused on three topics. 1) The announcement of Port O' CoCo becoming part of KCS, 2) Our commitment to get our club's system completed in the next 60 days, and 3) the look and organization of the PNW CoCo FEST IV. We agreed to have a very similar structure to last year's FEST. The three common observations were 1) the need for repeat presentations of topics so participants don't have to choose between two or three topics with no chance of getting his second choice at some later time, 2) smoother delivery of the two meals and 3) the swap meet and the breakfast need to be in two different areas so they don't conflict with each other.

Anyone wanting more information may mail their request to 3046 Banner Rd SE, Port Orchard WA 98366-8810 or call anytime (206) 871-6535 and leave your name and address.

==Donald Zimmerman==

Seattle 68xxxMUG

The April meeting of the Seattle 68xxxMUG started at 7:30 in Guggenheim Hall on the University of Washington campus. We began with the continued installation of Donald Zongker's CoCo-3 into a PC tower case. Last month **Rodger Alexander** wired the CoCo motherboard to accept regulated voltages from a PC power supply. This included removing the CoCo's power transistor and heat sink and adding a jumper between the 12 volt and 8 volt regulators on the motherboard.

At this meeting, Rodger jumpered the plus and minus 12 volt potentials to pin 1 and 2 of the ROMPAK port. This will necessitate that line 1 and line 2 traces be added to the card edge of the multipak. From the new trace lines on the multipak, jumpers were added to bring the voltage potentials to the 4 I/O slots. The result of all of this jumpering was to provide regulated voltages to the multipak directly from the CoCo's motherboard when the multipak is plugged into the CoCo. This eliminated the need to wire a separate plug assembly just for the multipak.

A demonstration of wireless networking a CoCo to a PC was scrapped when it was not possible to get the RS-232 to work with the CoCo under OS-9. Later it was determined that

the updated ACIA driver was bad. Hopefully this demonstration will be on tap for next month's meeting.

There was interest at the last meeting in the patches available to Multivuc. Did it really make a difference? So a demonstration of patching procedures and a disk with all of the current patches available from the club's public domain library was made available for all that had disk at the meeting. Included on the disk is a Basic09 program that automatically does all of the patches and then OS9Gen's a new Multivuc boot disk. Still to come is a demonstration running Multivuc with all of the ICONS loaded onto the RAM disk. Should make Multivuc really take off.

Donald Zimmerman gave a quick update report on the status of the Port O-CoCo Club joining with the Kitsap Computer Seniors. They have a membership of 450 and are legally organized as a non-profit group under the terms of the State of Washington and the IRS. Does this mean no PNW CoCoFEST this year?

Donald Zongker gave Donald Zimmerman a mail list of present, past and interested individuals. In an attempt to improve attendance numbers, Donald will be sending invitation/reminder notices to all those on the list. Money for postage is available in the club's account and is sufficient to cover a couple of months worth of mailing postcards. After that.....?

==Barbara Alexander==

SMALL GRAFX ECT.



"Y" & "TRI" cables, Special 40 pin	
MALE/FEMALE end connectors EA.	\$6.50
Rainbow 40 wire ribbon cable per/ft.	\$1.00
Hitachi HD63C09E CPU & Socket.	\$13.00
512K Upgrades.	\$72.00
MPI Pal upgarde. #26-3024 (chip),	
#26-3124 (Satellite Board).	\$10.00
Serial to Parallel w/64k Buffer	
Interface w/cables/ps	\$50.00
2400 Baud Hayes comb. Extl. Modems	\$40.00
<small>S&H EACH ORDER \$2.00</small>	
SERVICE, PARTS, & HARD TO FIND SOFTWARE, COMPLETE DOCUMENTATION AVAILABLE. INKS & REFILL KITS FOR CGP-220, CANNON & HP INKJET PRINTERS, RIBBONS, & Ver.6 EPROM FOR CGP-220 PRINTER(BOLD MODE). COLOR PRINTING.	
<p>TERRY LARAWAY N.W. 41 DONCEE DRIVE BREMERTON, WA 98310 206-692-5374</p>	

Washington State BBS List

COLUMBIA HTS. BBS

-- Longview/Kelso --
RiBBS (FidoNET)
(206) 425-5804

DATA WAREHOUSE BBS

-- Spokane --
RiBBS (FidoNET)
(509) 325-6787

TOP HAT BBS

-- Seattle --
PC-Board (PC-Net)
(206) 244-9661

PERMANENT CREW REST

-- Tacoma --
RiBBS (FidoNET)
(206) 472-6805

ULTIMATE EXPERIENCE BBS

-- Anacortes --
RiBBS (MaxNET)
(206) 299-0491

Bellingham OS-9 Users Forum

OS-9 and the Color Computer **\$7**
Tutorial and Hardware Hacker's Manual.
Includes 5-1/4 Disk of (360K) of upgrade software

Color Computer Video Library **\$10**
Fixing the MultiPak IRQ * Installing Floppy Drives
Installing 512K Memory * Installing B&B Hard Drive

OS-9 Newsletter **\$12/yr.**
12 monthly issues packed with OS9 Update, Tutorials,
Listings, Classifieds and PNW "Club Activity Reports"
Subscriber's Technical Support (206) 734-5806

Mail your order to: *Bellingham OS-9 Users Forum*
3404 Illinois Lane, Bellingham WA 98226

COPYRIGHT NOTICE

The *OS-9 Newsletter* is a copyrighted publication by the Bellingham OS-9 Users Forum; Rodger Alexander, Editor. Duplication and/or distribution is prohibited without written permission of the editor.

OS-9 Newsletter
3404 Illinois Lane
Bellingham, WA 98226-4238