

# CoCo~123

A publication of the Glenside Color Computer Club

Volume 41

Number 2

In this issue:

- Exploring Mega Mini MPI Sound
- Operating System Nine
- CoCoFEST! updates
- CoCo News from around the world
- And more!



Summer 2021



<http://lcurtisboyle.com/nitros9/nitros9.html>



<http://cloud9tech.com/>

**COCOMAN.BIZ**

maker of the switch-a-roo

<http://cocoman.biz>



<http://store.go4retro.com/>



<http://cocovga.com/>



The Zippster Zone

<https://thezipsterzone.com/>



<http://cococrew.org/>



<http://cocotalk.live/>



<https://anchor.fm/thecocoshow>



<http://www.tindie.com/stores/fiscap0768/>

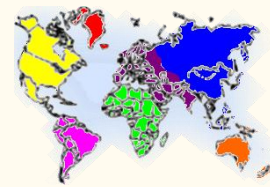

Glenside Color Computer Club, Inc.  
Volume 41, Number 2

Chicago, Illinois  
Summer 2021

## Memory Map

PRODUCTS, SERVICES, AND CONTENT	2
G.C.C.C. MEETINGS	3
G.C.C.C. OFFICERS	3
COCO~123 INFORMATION	4
COCO~123 CONTRIBUTORS	4
TREASURY NOTE\$	4
GCCC MEETINGS	4
THE COCO~123 DREAM TEAM	4
FROM THE EDITOR'S CLIPBOARD	4
FROM THE PRESIDENT'S PLATEN	5
SECRETARY'S SCROLL	6
2021 WEBMASTER UPDATE	6
WHERE IT ALL BEGAN	7
VICE PRESIDENT CHANGES	7
EXPLORING MEGA MINI MPI SOUND	8
COCOFEST! UPDATE	22
OPERATING SYSTEM NINE	23
COCO NEWS!	25
CALENDAR OF EVENTS	59
COCO COMMUNITY CORNER	60
(CLOSED PARENTHESES)	60

## G.C.C.C. Meetings

GCCC meetings are the 3<sup>rd</sup> Thursday of each month and are being held virtually via Blue Jeans until further notice. Upcoming meetings: July 15<sup>th</sup>, August 19<sup>th</sup>, and September 16<sup>th</sup> 2021.

## G.C.C.C. OFFICERS

If you have questions about the association, contact one of the officers for the answers.

<u>POSITION</u>	<u>NAME</u>	<u>E-MAIL</u>	<u>PRIMARY FUNCTION</u>
President	Jim Brain	<a href="mailto:president@glensideccc.com">president@glensideccc.com</a>	The buck stops here...
Vice-President	John Mark Mobley	<a href="mailto:vice-president@glensideccc.com">vice-president@glensideccc.com</a>	Meeting planning, etc.
Treasurer	Brian Goers	<a href="mailto:treasurer@glensideccc.com">treasurer@glensideccc.com</a>	Dues and purchasing
Secretary	Rich Bair	<a href="mailto:secretary@glensideccc.com">secretary@glensideccc.com</a>	Records and Reporting



Jim Brain



John Mark Mobley



Brian Goers



Rich Bair

## CoCo~123 Information

CoCo~123 is the newsletter of the Glenside Color Computer Club. Your annual contribution of \$15.00 helps to keep our club going. Send your check or online payment to:

Brian Goers, Glenside Treasurer  
PayPal to [Brian7eg@gmail.com](mailto:Brian7eg@gmail.com)  
Email [treasurer@glensideccc.com](mailto:treasurer@glensideccc.com)

Our treasury provides newsletters and good times with fellow CoCo users at our Annual "Last" Chicago CoCoFEST! and our Annual Glenside Picnic. Should you attend the Annual CoCoFEST! your annual contribution will be covered for that year.

## CoCo~123 Contributors

Special thanks to our contributors this issue: R. Allen Murphy and Rick Ulland,

## TREASURY NOTES



### March

Beginning Balance	\$ 14,088.91
Income	\$ 71.62
Expenses	\$ (5.00)
Ending Balance	\$ 14,155.53

### April

Beginning Balance	\$ 14,155.53
Income	\$ 7.58
Expenses	\$ (370.90)
Ending Balance	\$ 13,792.21

### May

Beginning Balance	\$ 13,792.21
Income	\$ 144.05
Expenses	\$ (283.24)
Ending Balance	\$ 13,653.02

Brian Goers, Treasurer  
Glenside Color Computer Club

## GCCC MEETINGS

The Glenside Color Computer Club meets the third Thursday of each month and are currently being held virtually through the BlueJeans video conference service.

<https://bluejeans.com/889394355>

Visit our website at:

<http://glensideccc.com>

## The CoCo~123 Dream Team

This publication is a joint effort of R. Allen Murphey, Tim Lindner, Paul Thayer, L. Curtis Boyle, and Salvador Garcia. Arranged and edited by Steve Strowbridge.

## From the Editor's Clipboard



The dog days of summer are here, and so is the latest issue of CoCo~123, a joint effort of our newsletter dream team, I continue to be impressed with what we're able to pull off, especially given the budget! The CoCo community continues to be active and thriving, lots of projects taking place in both hardware and software, and even a new series on programming in Assembly Language is starting on CoCoTALK! So, there's lots to keep us engaged with our CoCo hobby.

I'd like to give a super special thanks to Allen Murphey for tirelessly distilling all of the news content these past 3 months, gathering screen shots, putting them in a document, etc., and Tim Linder for helping to massage and proof the document. The source of the news comes from Curtis Boyle as he procures news from around the world for CoCoTALK! But we need to make this information more print friendly for the newsletter which can be quite time consuming.

It's looking a lot like an In-person CoCoFEST! this year, which I for one, am super excited about, so I hope to see as many people as possible this November. Until then, we've got a few more newsletters to work on, so I better get back on task with that. See y'all in the Fall!

Steve Strowbridge,  
Editor

Help us make CoCo~123 better each issue, send us submissions. Email your suggestions and contributions to [newsletter@glensideccc.com](mailto:newsletter@glensideccc.com)

## From the president's platen



If I'm honest, I'm struggling to keep up with the new projects, podcasts, and video offerings catering to the Color Computer lately. While some are from established CoCo enthusiasts, a number of them are from new faces I've not seen before. If you're one of those folks, welcome and thanks for spending some time with the CoCo or Dragon (Or MC-10, we're not judging). For everyone, I know there's lots of competition for your time and energy, and I'm glad you're focusing some of it here with us!

Though no CoCoFEST! event is ever 100% guaranteed, I am now extremely positive we'll meet in person come this November for the first time in over 2 years. Since the CoCo missed out on a great 40<sup>th</sup> birthday celebration in 2020, we'll belatedly congratulate the platform on reaching the big "4" "0" in style this year. Some may chide us for the levity, but I say any opportunity to eat cake is a good day. Send me flavor suggestions.

I know there's still almost 5 months between now and the Fest!, but if you have a project or presentation that's still but a thought in your mind, the time will disappear before you know it. We've opened table reservations on tandylist.com for the show, and Tony Podraza continues to solicit for speaker and presentations for the upcoming event. Please consider reserving a table for your project effort and/or a speaking time to share your CoCo thoughts. If you have already reserved a spot, thanks, and I'll try to gently nudge you to finish up your project or presentation. I'm as guilty as others in leaving far too much for the weeks before the fest, so let's all help each other stay focused as the beautiful weather and outdoor activities compete for our attention.

I mentioned this at the conclusion of the June general meeting, but I simply cannot wait to experience CoCoFEST! with all of you at our new location, the Holiday Inn at Elk Grove Village. As an attendee of a multi-platform classic computer festival in the Fall, the Vintage Computer Festival Midwest, I've already had the privilege of visiting and enjoying this venue during the years VCF Midwest utilized the facility (they've recently outgrown the venue due to increased popularity). Mind you, Heron Point will always hold a special place for me (many classic computer events in addition to CoCoFEST! have been held there over the years), with its revolving door, basement location, speedy (though sometimes unreliable) elevators, contemporary décor, and "comfy" size. And, I'll not soon forget the Fairfield Inn sharing the parking lot, with its foyer where everyone congregates for social discussions after the fest doors close for the night; Portillo's, just a couple miles East on North Avenue; and the restaurants across the street, which rather involved playing a real-life game of "Frogger" across North Avenue to reach by foot. Still, the new facility has its own charms, with more conference room space, direct attachment to the hotel, an on-premise restaurant, main floor location with "park at the door" loading directly into the venue, and (most importantly for some folks) a Portillo's a mere few blocks south of the venue right by a Taco Bell and McDonald's. Change is hard, I know, but I do hope you'll take this opportunity to visit us in 2021 at this incredible new location.

I want to take this opportunity to thank Terry Steege for his assistance as our 2020-21 Vice President. One can't always predict the future, and Terry's personal situation has become a bit too hectic as of late. Terry asked that we transition his duties to someone who can put a bit more focus on the club's efforts, and John Mark Mobley has graciously agreed to step in and carry the role forward. John Mark's well acquainted with the club, having fulfilled a number of roles such as newsletter editor and vice-president in the past, and I'm thankful he is able to assist.



Jim Brain  
Glenside President 2020-2021  
[president@glensideccc.com](mailto:president@glensideccc.com)

## Secretary's Scroll



The good news: There will be a 2021 CoCoFEST! Save the weekend of November 6 & 7, with Friday night setup for vendors on the 5th. Your officers are working hard to make this the best FEST! ever.

Several members who couldn't imagine an April without a CoCoFEST! also held an informal virtual "meet-up" via BlueJeans on the evening of April 24th, and a good time was had by all.

Glenside has now made our application to the IRS to be an approved 501c(3) non-profit organization. It's a serious matter. Assuming we are approved, we will need to keep more careful and detailed records, and there are annual reporting requirements, both to the IRS and to Illinois. Even the application fee to the IRS was a non-trivial \$275. But the club was incorporated in 1995 in Illinois as a not-for-profit, so this is a move to normalize our status between the two levels of government.

A change has occurred in the way the minutes of our monthly meetings are distributed, starting with the month of March. In the past I maintained an email list of those I thought would like to receive the reports (subject to feedback), but this responsibility has now been transferred to our Director of Digital Media, Eric Canales.

Our goal is to have a setting in each member's profile on TandyList which specifies whether that member wishes to receive (digitally) copies of the monthly meeting minutes (or a link to them). Eric will then use those settings to do a mailing. So as soon as these details are implemented by Randy Weaver, you will be able to opt in or opt out by updating your TandyList profile.

Happy CoCoing!



Rich Bair, Secretary  
Glenside Color Computer Club  
[mgdoc1@sbcglobal.net](mailto:mgdoc1@sbcglobal.net)

## 2021 Webmaster Update



Hello everyone to another quarterly newsletter. The sun is out and the temps are rising, so I've been making sure to run the AC so I can bring you all some more website updates!

Recently we've added more up to date details to our CoCoFEST! 2021 pages, so be sure to check that out. Randy Weaver has also launched CoCoFEST! registration so be sure to check that out.

For everyone as impatient as I am, we have also added a countdown timer so you can know down to the second how long it will be until CoCoFEST! 2021.

We hope to see you all there in November! Be sure to keep checking back on the website as we continually keep it up to date.



Eric Canales  
GCCC Webmaster  
[webmaster@glensideccc.com](mailto:webmaster@glensideccc.com)

## Where it all began



Glenside Public Library District in in Glendale Heights, Illinois. Photo Courtesy of Annette Swoger.

B.C. (That's before COVID), people used to do this thing called meeting in person, and back in those days, the Glenside Color Computer Club members would meet, in person at the public library.

# Exploring MEGA Mini MPI Sound

By R. Allen Murphey for Glenside Color Computer Club (GCCC)

## 1967-1971: Origins of Frequency Modulation (FM) Synthesis

The basis of the sound generation circuitry of the MEGAmulti-Pak Interface (MMMPI) draws from analog radio broadcasting dating back to 1914 and research into spatial audio acoustics in the late 1960s.

In 1967, John Chowning, a researcher at the Stanford Artificial Intelligence Lab discovered a novel combination of the the mathematics of Frequency Modulation and his passion for music.

In 1972, he composed Turenas (an anagram of Natures) as a demonstration of his ideas on FM Synthesis and sound spatialization.

In 1973 he published the fundamental paper on how to create these new sounds using FM synthesis, The Synthesis of Complex Audio Spectra by Means of Frequency Modulation.

\_Turenas\_: The Realization of a Dream

<https://ccrma.stanford.edu/~cc/deck.js/surroundSnd2018/pdf/turenas- the realization of a dream.pdf>

John Chowning performs Turenas:

<https://www.youtube.com/watch?v=kSbTOB5ft5c>

John M. Chowning,

"The Synthesis of Complex Audio Spectra by Means of Frequency Modulation," Journal of the Audio Engineering Society Vol. 21, # 7 pp 526-534 (Sept. 1973); reprinted in Computer Music Journal, Vol. 1, # 1, pp 46-54 (April 1977).

[https://ccrma.stanford.edu/sites/default/files/user/jc/fm\\_synthesispaper-2.pdf](https://ccrma.stanford.edu/sites/default/files/user/jc/fm_synthesispaper-2.pdf)

## Frequency Generation = Oscillation

A signal, such as audible sound, is fundamentally a medium changing back and forth smoothly between two values. This is known as oscillation, such as an oscillating fan turning back and forth. With sound, the medium that moves back and forth are pressure waves in the air. In electronics, the medium that moves back and forth are the electrons in the wire. If a wire with an oscillating signal is connected to a transducer (such as an audio speaker) then the oscillating electrical signal is converted into movement of the speaker, generating pressure waves which match the signal, producing a sound if the frequency is low enough to be in the range of human hearing.

Frequency is the measure of the number of times a wave oscillates, or cycles, back and forth in a given amount of time.

The measurement unit of frequency is the Hertz (Hz), named after Heinrich Hertz the discoverer of electromagnetic waves.

## Modulation

A simple oscillating signal or sound is a useful, but not dramatically exciting thing. Many folks have heard the test tone broadcast by a television station when it is off the air. This is a simple oscillating sinusoidal wave at 1000 cycles per second. It is a "pure" tone. To make it more exciting, we need to mix in additional signals to change that simple sine wave into something more dynamic. Early electric organs also used simple sine waves for their sound generation.

## Additive Synthesis

For our first trick, we can simply add two different sine wave signals together. This creates a much more dynamic signal by varying the predictability of the sound, and creating harmonics where the waves generated by the two different signals adding and canceling parts of each other.

## FM Synthesis

What John Chowning came up with was the next step in creating or shaping dynamic sounds by varying one sine wave frequency using the shape of another sine wave as an input to the first sign wave. By mathematically varying the terms of the formula to generate the "carrier" sine wave, and the values of the "modulating" sine wave, he could mathematically "shape" the signal into complex sounds that resembled a large number of naturalistic sounds and traditional instruments. The sounds of an instrument's fundamental and harmonic frequency characteristics is known as its "timbre."

## Amplitude = Loudness

In addition to varying the frequency of a signal, you can also vary the amplitude. For audible signals, amplitude is the loudness of the sound. The amplitude of a sound wave is measured in decibels (dB) which are tenths of a bel named after Alexander Graham Bell.

## Envelope

Playing the same note on different instruments results in many different kinds of sound. When you look at how the loudness of a note produced by an instrument changes over time, you find that some instruments make a sudden changes in loudness producing sharp, sudden sounds while others smoothly ramp their loudness up and down over time. The "shape" of that loudness change is known as the envelope of the sound, and is another component you can control to generate complex sounds as well.



Typical measurements for the envelope “shape” of a sound are attack (how fast the sound rises to maximum volume), decay (how fast the sound “falls off” in volume from maximum), sustain (the volume level a sound stays at while continuing to sound), and release (how fast the volume falls back to zero once the sound is stopped playing).

A percussion instrument or string, for example, has a fast attack. When the drum is hit or the string plucked or hammered, the sound immediately goes to its full sound. However, what happens next can be totally different between the two. A percussion sound immediately decays back to zero, usually with little or no sustain or release. However a piano string may continue vibrating or oscillating for quite a long time after being hammered. Using the sustain pedal removes the damping effect letting the string sound for as long as possible. When you let off the sustain pedal, the damper then mutes the string quickly. These are examples of how these four characteristics combine to shape the volume or loudness of sounds.

### **1983: FM Meets MIDI: The Yamaha DX7 Synthesizer**

Ironically, Stanford denied John Chowning’s tenure and professorship after this new sound generation capability was rejected by the (then) largest electric instrument maker, Hammond Organs. The technology was too new, and too different from what Hammond had built their entire business on and they were not visionary or risk-taking enough to try it. However, John Chowning’s discovery was the solution to a problem that an overseas piano and synthesizer maker had spent decades trying to solve. The Yamaha corporation licensed John Chowning’s discovery from Stanford, becoming one of its most lucrative licenses ever and earning John Chowning his professorship.

Throughout the 1970’s Yamaha began building and expanding on the core FM Synthesis line of circuits and synths. Meanwhile, Dave Smith of Sequential Circuits presents the [Universal Synthesizer Interface](#) and Roland’s Ikutaro Kakehashi drives the effort standardize it into what became MIDI 1.0 in 1982. In 1983, Yamaha merged FM Synthesis with this new MIDI standard to unleash what would become one of the most recognizable and iconic synthesizers in history: the Yamaha DX-7.

Five large-scale integrated (LSI) chips form the core of the DX-7: The 6303 main processor, the 6805 sub-processor, the YM21280 OPS Operator-S, the YM21290 EGS Envelope Generator-S, and the BA9221 Digital-to-Audio Converter (DAC).

The DX-7 creates sound using a sine wave oscillator feeding six “operators” which are the combination of an FM “carrier” modulated by a second FM signal and an envelope generator.

The resulting digital signal representing the sounds to output is fed to the DAC and out to the speakers.

A key capability of the DX-7 is a very large number of ways to combine “operators” for even more complex sound generating. The DX-7 comes with 32 “algorithms” which combine the operators with feedback loops letting the signals from operators modulator or change signals in one or more other operators.

Luckily for the world of 1980’s music, the DX-7 also came with preset sounds carefully worked out by the Yamaha engineers. Given the complexity of all of these operator and algorithm choices, combined with the fact the machine was built on entirely new principles of sound generation basically resulted in a beast that was fearsome and confusing to program. That reputation exists to this day.

Musicians who did experiment with and master this new machine, such as the legendary Herbie Hancock, fell in love with it and the infinitely complex arrays of new sounds it could create with patience and practice. But there are a legion of artists who were able to become household names using just the presets.

The Sound of One Chip Clapping: Yamaha and FM Synthesis  
[https://www.academia.edu/2680140/The\\_sound\\_of\\_one\\_chip\\_clapping\\_Yamaha\\_and\\_FM\\_synthesis](https://www.academia.edu/2680140/The_sound_of_one_chip_clapping_Yamaha_and_FM_synthesis)

A Brief History of MIDI:  
<https://www.midi.org/midi-articles/a-brief-history-of-midi>

### **1985: CAPTAIN and the Yamaha YM3526 (OPL)**

In the late 1970s and early 1980s, Yamaha also applied this FM Synthesis technology to other projects requiring sounds. One project was a Japanese videotex service called CAPTAIN: Character and Pattern Telephone Access Information Network. The CAPTAIN service went through two trials from 1979 to 1981 and 1981 to 1983 when it finally launched as a commercial videotext service. By December 1985 it had 650 information providers, and was in 245 cities by 1986. The service closed in 2002. CAPTAIN was unique in that it required a whole different approach to send Japanese kanji characters over the network. Rather than include a bitmap ROM font generator like European and American videotex systems, CAPTAIN sent facsimile-style pictures of the characters.

To support CAPTAIN, Yamaha created an FM Synthesis sound chip based on its FM Operator-L (OPL) circuit. The chip was the Yamaha YM3526 which would be paired with the Yamaha YM3014 DAC to generate sound. The YM3526 implements a scaled-down version of the FM Operator and Envelope Generator chips which powered the mighty Yamaha DX-7, but this time in a single chip. Like the DX-7, the YM3526 has a

single sine wave generator powering the operators. Unlike the DX-7 with 6 operators and 32 algorithms, the YM3526 has 18 operators but only 2 algorithms for generating sounds which are similar to, but not as mathematically complex as, the DX-7's output. Also unlike the DX-7, the YM3526 did support a new feature for CAPTAIN: Complex Sinusoidal Modeling (CSM), where all of the operators combined into a single complex sound generation system capable of being software controlled to reproduce speech. This was likely a requirement for the videotex service to use in automated messaging, and will be dropped by the time we get to the chip in the MEGAmimi-MPI.

The good news for us is that everything available to program the YM3526 (except CSM) is available to us for programming the MMMPI's sound. The YM3526's OPL sound standard is the basis for later sound chips which are backwards compatible to

OPL but add new features. We can use this as a way to learn about the programming in stages. This first means tackling the initially confusing and complex-looking data sheet.

One excellent source for the data sheet and information about this chip is the Video Game Music Preservation Foundation:

<http://www.vgmpf.com/Wiki/index.php?title=YM3526>

IMPORTANT NOTE: Bear with me for the next bits as we wade into the deep end of the pool – just keep paddling to the end and hopefully it will all make sense by then. It took me quite a bit of head-scratching to assimilate how this works, but it does all logically come together once you get past what each new unfamiliar part is. This next bit is looking at all of the pieces of the puzzle before we get to what the puzzle looks like when put together.

### Tour of the Block Diagram

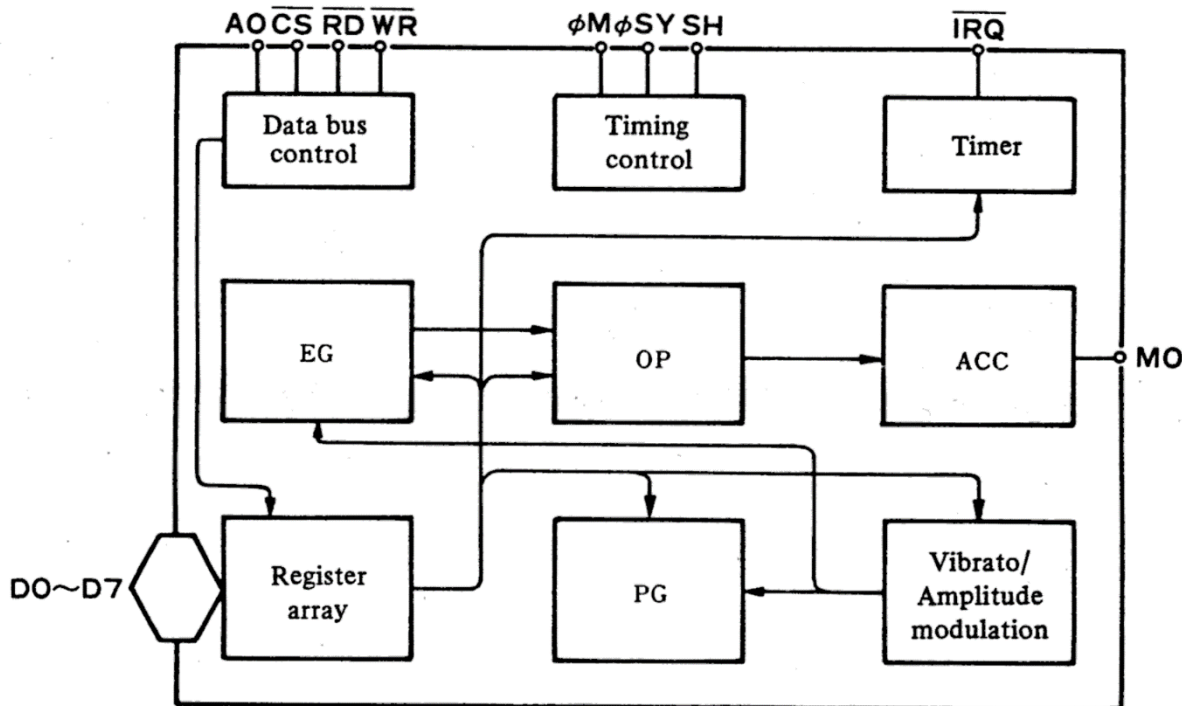

Generating sound with the YM3526 requires configuring the Operators (OP) and Envelope Generators (EG) using the Register Array connected to a microcomputer bus (D7-D0 are data lines back to the computer). Internally, the YM3526 uses its Phase Generator (PG) to create the core sine wave steps for the Operators to modulate, and includes additional circuits for Vibrato and other effects. All of the generated sound steps feed digitally into the Accumulator (ACC) and out to an external DAC to become sound.

OPL works in one of two main "configurations":

1. The 18 "operators" in the chip are used in pairs to generate up to 9 simultaneous "melody" or non-percussion instrument sounds (also known as timbres).
2. The 18 operators are used in two groups: 12 of the operators are paired to generate up to 6 simultaneous "melody" sounds, while the remaining 6 operators are used to generate up to 5 simultaneous "rhythm" or percussion sounds at the same time as the melodies.

## An Operator with Feedback

The YM3526 contains 18 FM Operators which all include feedback control for additional sound complexity.

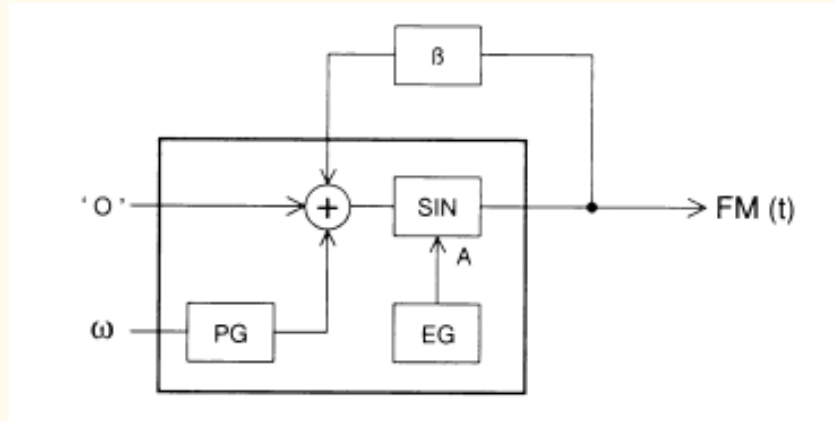

## Algorithms

Two or more operators chained together form an "algorithm" combining a Carrier and a Modulator to create more complex harmonics.

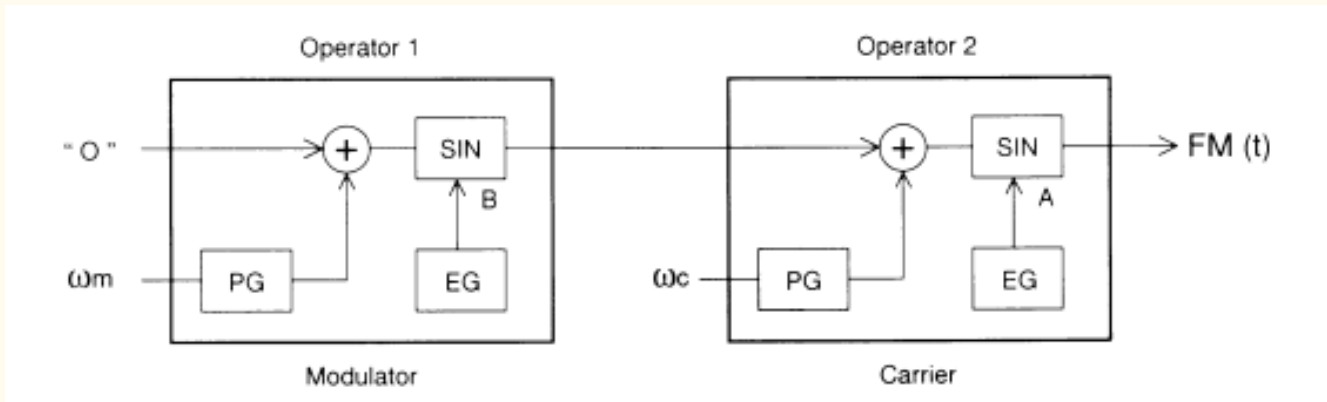

The YM3525 also offers a channel configuring adding the two wave forms to allow you to use more traditional FM additive synthesis as well.

The sound produced from the additive synthesis is simpler and sounds a bit like the sounds generated from the Programmable Sound Generators which came before FM Synthesizers.

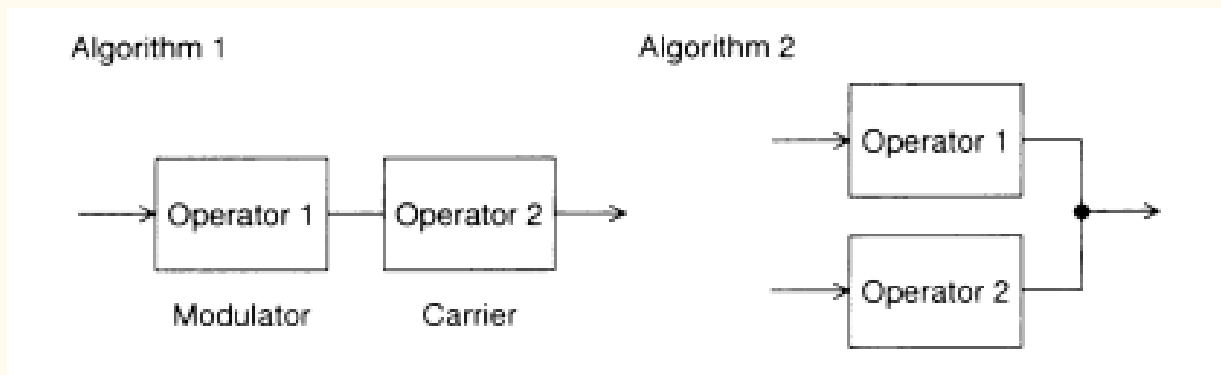

The Register Array

ADDRESS	D <sub>7</sub>	D <sub>6</sub>	D <sub>5</sub>	D <sub>4</sub>	D <sub>3</sub>	D <sub>2</sub>	D <sub>1</sub>	D <sub>0</sub>	COMMENT
01	TEST								LSI TEST DATA
02	TIMER - 1								TIMER - 1 DATA
03	TIMER - 2								TIMER - 2 DATA
04	RST	MASK T1 T2						ST2ST1	IRQ RESET/TIMER CONTROL
08	CSM	SEL							CSM speech synthesis mode/Note Select.
20	AM	VIB	EG-TYP	KSR	MULTI				AM/VIB/EG-TYPE/KSR/MULTIPLE
35									
40	KSL		TL						KSL/TOTAL LEVEL
55									
60	A R				D R				ATTACK RATE/DECAY RATE
75									
80	S L				R R				SUSTAIN RATE/RELEASE RATE
95									
A0	F-Number (L)								
A8									
B0			KON	BLOCK			F-Num (H)		KON/BLOCK/F-Number
B8									
BD	DEP AM VIB	R	BD	SD	TOM	TC	HH		DEPTH (AM/VIB)/RHYTHM (BD·SD·TOM·TC·HH)
C0					F B		C		FEEDBACK/CONNECTION
C8									

■ STATUS REGISTER

IRQ	FLAG T1 T2					
-----	---------------	--	--	--	--	--

IRQ/FLAG (T1, T2)

## Group 1: Chip Controls (Register Address 00-08)

Carefully hidden in the “Address” column is the fact that there are 3 different groupings of registers here. The first grouping are “chip control” where the register affects the configuration of the entire chip at once: Registers 01-08.

## Register Group 2: Operator Controls (Register Address 20-95)

The second grouping are registers that control each of the 18 FM Operators: addresses 20-95. The diagram shows the layout and content of one operator’s worth of registers. For example, FM Operator 0 is configured with Register 20, 40, 60, and 80. FM Operator 3 is configured with Register 23, 43, 63, and 83. FM Operator 0 and 3 are paired together to create one resulting sound channel (more on this in a bit). FM Operator 0 is used as the Modulator of the pair, with FM Operator 3 used as the Carrier.

The first annoying headache in the data sheet is that the registers for operators are subdivided into 3 groups with gaps in the registers used. This means you cannot simply fire off 18 writes in a row starting at operator 0’s register and sequentially step through programming all 18 operators in a simple loop.

Instead, Operators 0-6 use Registers 20-25, 40-45, 60-65, and 80-85.

The Registers 26-27, 46-47, 66-67, and 86-87 are skipped and unused.

Next Operators 7-12 use Registers 28-2D, 48-4D, 68-6D, and 88-8D.

The Registers 2E-2F, 4E-4F, 6E-6F, and 6E,8F are skipped and unused.

Finally, Operators 13-18 use Registers 30-35, 50-55, 70-75, and 90-95.

This mapping of Operator registers took me quite a while to get my head around.

Some examples:

Operator 0: Registers 20, 40, 60, and 80.

...

Operator 5: Registers 25, 45, 65, and 85.

<skip>

Operator 6: Registers 28, 48, 68, and 88.

...

Operator 11: Registers 2D, 4D, 6D, and 8D.

<skip>

Operator 12: Registers 30, 50, 70, and 90.

...

Operator 17: Registers 35, 55, 75, and 95.

## Tour of the Operator Registers

I am not going to include the full register programming information here. Instead, I will include the link (later) to an application guide which covers all of the necessary details far more fully than I can cover here.

Instead, I will focus on the main registers needed to get started creating sounds, which can hopefully give you the basis to go as far as you like with the full chip reference in hand.

Let’s look at what it takes to program the Operator 0 (Modulator) and Operator 3 (Carrier) Registers with instrument or timbre data to generate sound on channel 0.

Register 20 gives us 5 controls

Bit 7 turns on and off Amplitude Modulation which causes a periodic warble in the volume, also known as Tremolo.

Bit 6 turns on and off Vibrato, which is a periodic warble in the frequency.

Bit 5 selects one of two Envelope Generators, 0 for Percussive, and 1 for Non-Percussive.

Bit 4 turns on and off Key Scaling Rate which simulates how higher pitched sounds play faster, or not.

Bits 3 through 0 control the Frequency Multiplier which change the relationships (ratios) between the fundamental and harmonic waves in the sound generated.

Register 40 gives us 2 controls:

Bit 7-6 are the Key Scaling Level

Bits 5-0 are the Total Level, which is really how much sound attenuation (volume control) you want on the sound.

Register 60 gives us two controls:

Bits 7-4 are the Attack Rate (AR) which is how fast the sound rises from zero to peak.

Bits 3-0 are the Decay Rate (DR) which is how fast the sound falls from peak to sustain level.

Register 80 gives us two controls:

Bit 7-4 are the Sustain Level (SL) which is how loud the sound us while you “hold” the note playing.

Bit 3-0 are the Release Rate (RR) which is how fast the sound volume fades to zero once you stop holding the note playing.

Registers 60 and 80 combine with the EG-type bit in Register 20 to control the overall volume envelope “shape” of the sound, visualized like this:

This configures the Modulator half of sound channel 0. The same settings can be configured independently on registers 23, 43, 63, and 83 to configure the Carrier half of sound channel 0.

### ☐ Percussive sound

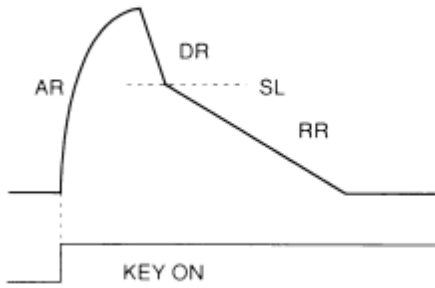

### ☐ Non-percussive sound

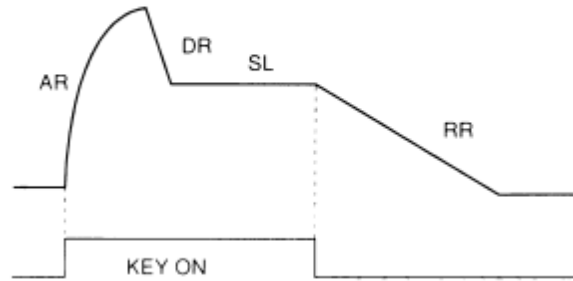

## An Example Instrument Timbre

Decoded below is an instrument definition for an Accordion. Operator 0 is used for the FM Modulation and Operator 3 is used for the FM Carrier. The register numbers and related bit numbers are shown for each part of the timbre definition. The variables I used start with MOD for Modulator and CAR for Carrier.

```
Instrument: 0 NAME .....: ACCORDN
Instrument: 0 IPERCUSSIVE .....: 0
Instrument: 0 IVOICENUM .....: 0
Instrument: 0 0x40 [7:6] OP0 MODKSL .....: 1
Instrument: 0 0x20 [3:0] OP0 MODMULTIPLE ...: 4
Instrument: 0 0xC0 [3:1] OP0 MODFEEDBACK ...: 7
Instrument: 0 0x60 [7:4] OP0 MODATTACK .....: 15
Instrument: 0 0x80 [7:4] OP0 MODSUSTAIN .....: 0
Instrument: 0 0x20 [5] OP0 MODEG .....: 1
Instrument: 0 0x60 [3:0] OP0 MODDECAY .....: 2
Instrument: 0 0x80 [3:0] OP0 MODRELEASE .....: 11
Instrument: 0 0x40 [5:0] OP0 MODLEVEL .....: 15
Instrument: 0 0x20 [7] OP0 MODAM .....: 0
Instrument: 0 0x20 [6] OP0 MODVIB .....: 0
Instrument: 0 0x20 [4] OP0 MODKSR .....: 0
Instrument: 0 0xC0 [0] OP0 MODCON .....: 1
Instrument: 0 0x43 [7:6] OP1 CARKSL .....: 0
Instrument: 0 0x23 [3:0] OP1 CARMULTIPLE ...: 1
Instrument: 0 0xC0 [3:1] OP1 CARFEEDBACK ...: 4
Instrument: 0 0x63 [7:4] OP1 CARATTACK .....: 5
Instrument: 0 0x83 [7:4] OP1 CARSUSTAIN .....: 0
Instrument: 0 0x23 [5] OP1 CAREG .....: 1
Instrument: 0 0x63 [3:0] OP1 CARDECAY .....: 2
Instrument: 0 0x83 [3:0] OP1 CARRELEASE .....: 11
Instrument: 0 0x43 [5:0] OP1 CARLEVEL .....: 0
Instrument: 0 0x23 [7] OP1 CARAM .....: 0
Instrument: 0 0x23 [6] OP1 CARVIB .....: 0
Instrument: 0 0x23 [4] OP1 CARKSR .....: 1
Instrument: 0 0xC0 [0] OP1 CARCON .....: 1
```

Luckily for everyone involved, we don't have to create these ourselves in code. More on that in a bit.

### Register Group 3: Channel Controls (Register Address A0-C8)

The third group control the 9 or 11 sound channels created by combining pairs of operators into sound channels: A0-C8. If you configure the chip's 18 operators into 9 melody channels, then Registers A0, B0, and C0 configure sound channel 0. Registers A1, B1, and C1 control sound channel 1 and so on up to Registers A8, B8, and C8 configuring sound on channel 8.

If you configure the chip for 6 melody and 5 rhythm channels, then A0,B0,C0 are sound channel 0 are before. But, sound channel 6 (Registers A6,B6,C6) is now configured for the Bass Drum (BD). Channel 7 (Registers A7, B7, C7) configures the Snare Drum and Tom Tom using 1 operator each. And Channel 8 (Registers A8,B8,C8) configure settings for the Top Cymbal and High-Hat rhythm sounds.

The second annoying and confusing part of the data sheets come from the Yamaha engineers using and reusing the term "slot" to refer to individual operators in a pair, as well as the sound channel resulting from a pair of operators working together. For my own sanity, I stopped using the term "slot" at all, and instead focus on configuring one of the 18 operators, or one of the 9 / 11 sound channels created from operators.

The third annoying thing, for a programmer at least, is that register numbers for things are assigned and counted starting from zero but documented with counts starting at 1. Where I describe Channel 0-9, the documentation from Yamaha will describe Channels 1-9. I've counted from zero in these examples to align channels and Register Addresses logically together.

This also took me a bit of time to fully grasp.

In 9-channel mode:

Operator 0 and 3 combine into Channel 0 controlled by Register A0, B0, and C0.

Operator 1 and 4 combine into Channel 1 controlled by Register A1, B1, and C1.

Operator 2 and 5 combine into Channel 2 controlled by Register A2, B2, and C2.

Operator 6 and 9 combine into Channel 3 controlled by Register A3, B3, and C3.

Operator 7 and 10 combine into Channel 4 controlled by Register A4, B4, and C4.

Operator 8 and 11 combine into Channel 5 controlled by Register A5, B5, and C5.

Operator 12 and 15 combine into Channel 6 controlled by Register A6, B6, and C6.

Operator 13 and 16 combine into Channel 7 controlled by Register A7, B7, and C7.

Operator 14 and 17 combine into Channel 8 configured by Register A8, B8, and C8.

The main use of these registers is to set the frequency (note) to generate, and turn on and off generating the sound itself.

Registers A8-A8 and B0-B8 bits 1-0 are where you program the 10-bit "F-Number" within an octave.

Registers B0-B8, bits 4-2 select which Block, or Octave you are generating notes in.

Middle C and A440 are in "Block 4"

With Block 4 set, the F-Numbers for the 12-note scale are:

Note	Frequency (Hz)	F-Number
C	261.6	346
C#	277.2	367
D	293.7	389
D#	311.1	412
E	329.6	436
F	349.2	462
F#	370.0	490
G	392.0	519
G#	415.3	550
A	440.0	582
A#	466.2	617
B	523.3	654

Full note tables are provided in the references described at the end.

To simulate pressing a piano key and turn on playing a melody sound, set the Key On (KON) bit of the Register B0-B8. This will trigger the sound to start playing using all of the timbre and envelope settings we previously setup. Turn off the KON bit to simulate releasing the piano key and let the sound release according to the timbre and envelope settings.

In 11-channel mode, you program sounds from channels 0-5 as described above.

Operators 12 and 15 combine into the Bass Drum percussion channel.

Operator 13 is for the Snare Drum percussion channel.

Operator 14 is for the Top Cymbal percussion channel.

Operator 16 is for the Hi-Hat percussion channel.

Operator 17 is for the Tom Tom percussion channel.

To trigger a sound on each of the percussion channels, the appropriate bit of Register BD is toggled on and off instead of using the Key-On bit for the channel (Registers B6-B8) which is left off.

### Programming the YM3526 from your CoCo

Congratulations, you have made it through the worst.

Despite the complexity, once I got my head around the stuff above, it turns out to be surprisingly easy to program this chip.

You “design” a sound (timbre) and program it into the operators on the channel you want to generate the sound with Registers 20-95.

Then you program the sound channel with the note frequency data, “key it on” to start it making noise on that channel, and later “key it off” to stop the noise from that channel with Registers A0-C8.

The fun starts in designing the timbres from the modulator and carrier shaping all sorts of traditional or new and unique sounds.

To do that, we need to some setup then fire off some notes.

1. Configure the CoCo to route sound from Cartridge Port to TV.
2. Configure the MMMPI to route sound from its OPL chip to the Cartridge Port.
3. Configure the MMMPI to map the OPL chip registers into CoCo memory at FF50-FF55.
4. Reset the OPL chip.
5. Configure the OPL for 9 melody channels or 6 melody with 5 rhythm.
6. Configure an instrument timbre for the OPL to generate sounds with.
7. Finally, play some notes!

To program sound on the MEGAmimi, we can use \$FF50 to select which register in the OPL chip to read or write, and \$FF51 to set or get the data to and from the selected register.

But first, we can use \$FF54 to reset the sound chip and the MMMPI uses the same \$FF7F to select the MPI slot as the traditional Tandy MPI does.

### BASIC

In the interest of focus, excerpts from a much larger BASIC example posted to the CoCo Discord (<https://discord.cocotalk.live>) #mmpmi-sdc-extender-opl3 channel are displayed here.

1. Configure the CoCo Multiplexer for Cartridge Port Sound

```
30 X1=PEEK (&HFF01) :X1=X1 AND &HF7:POKE
&HFF01,X1
40 X2=PEEK (&HFF03) :X2=X2 OR &H08:POKE
&HFF03,X2
50 X3=PEEK (&HFF23) :X3=X3 OR &H08:POKE
&HFF23,X3
```

2. Configure the MEGAmimi MPI Multiplexer for internal OPL using Virtual Slot 16

```
60 X4=PEEK (&HFF7F) :X4=X4 AND &HF0:X4=X4
OR &H0F:POKE &HFF7F,X4
70 POKE &HFF42,&H04
```

3. Select the MMMPI Virtual Slot 5

```
80 X5=PEEK (&HFF7F) :X5=X5 AND &HF0:X5=X5
OR &H04:POKE &HFF7F,X5
```

4. Reset the OPL Chip

```
85 POKE &HFF54,&H00
```

5. Configure Synthesizer Chip for 6 melody and 5 rhythm channels

```
90 POKE &HFF50,&HBD: POKE &HFF51,
&H20:'BIT 5 RHY MODE
```

6. Configure Instrument Timbre

The choice of instrument data goes in R2, R4, R6, and R8.

The full demo program on the Discord uses lines 100-499 to decode and setup the instrument data. Ouch.

```
RUN
INSTRUMENT: ACCORDN
MR2:F4
MR4:4F
MR6:F2
MR8:B
MRC:0
CR2:F1
CR4:0
CR6:52
CR8:B
CRC:0
MRE:0
CRE:0
PLAYING SCALE...
NEXT?
```



Fill in Register Values for your Instrument (Accordion shown above)

```
R2=&HF4:R4=&H4F:R6=&HF2:R8=&H0B:RA=0:RC=0:RE=0
```

Melodic Instrument Registers (20, 40, 60, 80)

```
520 POKE&HFF50,&H20:POKE&HFF51,R2:
PRINT"MR2:";HEX$(R2)
530 POKE&HFF50,&H40:POKE&HFF51,R4:
PRINT"MR4:";HEX$(R4)
540 POKE&HFF50,&H60:POKE&HFF51,R6:
PRINT"MR6:";HEX$(R6)
550 POKE&HFF50,&H80:POKE&HFF51,R8:
PRINT"MR8:";HEX$(R8)

560 POKE&HFF50,&HC0:POKE&HFF51,RC:
PRINT"MRC:";HEX$(RC)

940 POKE&HFF50,&HE0:POKE&HFF51,RE:
PRINT"MRE:";RE
```

Now set the register values for the Carrier Operator:

```
R2=&HF1:R4=&H00:R6=&H52:R8=&H0B
```

Program the Carrier Operator

```
880 POKE&HFF50,&H23:POKE&HFF51,R2:
PRINT"CR2:";HEX$(R2)
890 POKE&HFF50,&H43:POKE&HFF51,R4:
PRINT"CR4:";HEX$(R4)
900 POKE&HFF50,&H63:POKE&HFF51,R6:
PRINT"CR6:";HEX$(R6)
910 POKE&HFF50,&H83:POKE&HFF51,R8:
PRINT"CR8:";HEX$(R8)
920 POKE&HFF50,&HC3:POKE&HFF51,RC:
PRINT"CRC:";HEX$(RC)
```

Percussion Instrument Registers (Modulator 30,50,70,90 and Carrier 33,53,73,93)

NOTE: This is programming a Melody channel for complex percussion without added noise. The Percussion mode channels 6-8 internally add noise for those percussion timbres. These are two ways to get the same end, whether you need noise added or not.

```
562 POKE&HFF50,&H30:POKE&HFF51,R2:
PRINT"MR2:";HEX$(R2)
563 POKE&HFF50,&H50:POKE&HFF51,R4:
PRINT"MR4:";HEX$(R4)
564 POKE&HFF50,&H70:POKE&HFF51,R6:
PRINT"MR6:";HEX$(R6)
```

```
565 POKE&HFF50,&H90:POKE&HFF51,R8:
PRINT"MR8:";HEX$(R8)
566 POKE&HFF50,&HC6:POKE&HFF51,RC:
PRINT"MRC:";HEX$(RC)
922 POKE&HFF50,&H33:POKE&HFF51,R2:
PRINT"CR2:";HEX$(R2)
923 POKE&HFF50,&H53:POKE&HFF51,R4:
PRINT"CR4:";HEX$(R4)
924 POKE&HFF50,&H73:POKE&HFF51,R6:
PRINT"CR6:";HEX$(R6)
925 POKE&HFF50,&H93:POKE&HFF51,R8:
PRINT"CR8:";HEX$(R8)
926 POKE&HFF50,&HC6:POKE&HFF51,RC:
PRINT"CRC:";HEX$(RC)
```

7. Configure Voice Registers: Note On and Off

Playing the Scale using a Melody Channel

The delay loop L is used to give the envelope time to play after KEY ON and before KEY OFF.

```
980 POKE &HFF50,&HA0: POKE &HFF51,&H6B:
POKE&HFF50,&HB0: POKE &HFF51,&H31: FOR
L=0 TO 250:NEXT: POKE &HFF50,&HB0: POKE
&HFF51,&H00: 'C#
990 POKE &HFF50,&HA0: POKE &HFF51,&H81:
POKE&HFF50,&HB0: POKE &HFF51,&H31: FOR
L=0 TO 250:NEXT: POKE &HFF50,&HB0: POKE
&HFF51,&H00: 'D
1000 POKE &HFF50,&HA0: POKE &HFF51,&H98:
POKE&HFF50,&HB0: POKE &HFF51,&H31: FOR
L=0 TO 250:NEXT: POKE &HFF50,&HB0: POKE
&HFF51,&H00: 'D#
1010 POKE &HFF50,&HA0: POKE &HFF51,&HB0:
POKE&HFF50,&HB0: POKE &HFF51,&H31: FOR
L=0 TO 250:NEXT: POKE &HFF50,&HB0: POKE
&HFF51,&H00: 'E
1020 POKE &HFF50,&HA0: POKE &HFF51,&HCA:
POKE&HFF50,&HB0: POKE &HFF51,&H31: FOR
L=0 TO 250:NEXT: POKE &HFF50,&HB0: POKE
&HFF51,&H00: 'F
1030 POKE &HFF50,&HA0: POKE &HFF51,&HE5:
POKE&HFF50,&HB0: POKE &HFF51,&H31: FOR
L=0 TO 250:NEXT: POKE &HFF50,&HB0: POKE
&HFF51,&H00: 'F#
1040 POKE &HFF50,&HA0: POKE &HFF51,&H02:
POKE&HFF50,&HB0: POKE &HFF51,&H32: FOR
L=0 TO 250:NEXT: POKE &HFF50,&HB0: POKE
&HFF51,&H00: 'G
1050 POKE &HFF50,&HA0: POKE &HFF51,&H20:
POKE&HFF50,&HB0: POKE &HFF51,&H32: FOR
L=0 TO 250:NEXT: POKE &HFF50,&HB0: POKE
&HFF51,&H00: 'G#
1060 POKE &HFF50,&HA0: POKE &HFF51,&H41:
POKE&HFF50,&HB0: POKE &HFF51,&H32: FOR
L=0 TO 250:NEXT: POKE &HFF50,&HB0: POKE
&HFF51,&H00: 'A
```

```

1070 POKE &HFF50,&HA0: POKE &HFF51,&H63:
POKE&HFF50,&HB0: POKE &HFF51,&H32: FOR
L=0 TO 250:NEXT: POKE &HFF50,&HB0: POKE
&HFF51,&H00: 'A#
1080 POKE &HFF50,&HA0: POKE &HFF51,&H87:
POKE&HFF50,&HB0: POKE &HFF51,&H32: FOR
L=0 TO 250:NEXT: POKE &HFF50,&HB0: POKE
&HFF51,&H00: 'B
1090 POKE &HFF50,&HA0: POKE &HFF51,&HAE:
POKE&HFF50,&HB0: POKE &HFF51,&H32: FOR
L=0 TO 250:NEXT: POKE &HFF50,&HB0: POKE
&HFF51,&H00: 'C

```

Playing A Percussion Sound on the dedicated percussion channels.

NOTE: B=# refers to Instrument Maker / Bank data format for timbres shown later.

```

1092 IF B=6 THEN POKE &HFF50, &HBD: POKE
&HFF51, &H30: FOR L=0 TO 100:NEXT: POKE
&HFF50, &HBD: POKE &HFF51, &H20
1092 IF B=7 THEN POKE &HFF50, &HBD: POKE
&HFF51, &H28: FOR L=0 TO 100:NEXT: POKE
&HFF50, &HBD: POKE &HFF51, &H20
1092 IF B=8 THEN POKE &HFF50, &HBD: POKE
&HFF51, &H24: FOR L=0 TO 100:NEXT: POKE
&HFF50, &HBD: POKE &HFF51, &H20
1092 IF B=9 THEN POKE &HFF50, &HBD: POKE
&HFF51, &H22: FOR L=0 TO 100:NEXT: POKE
&HFF50, &HBD: POKE &HFF51, &H20
1092 IF B=10 THEN POKE &HFF50, &HBD:
POKE &HFF51, &H21: FOR L=0 TO 100:NEXT:
POKE &HFF50, &HBD: POKE &HFF51, &H20

```

### 1987 Yamaha YM3812 (OPLII) – Ad Lib Sound





In 1987, Yamaha updated their FM Operator-L standard to add additional sine wave generation options and faster programming of the registers.

This is known as the OPLII standard, implemented in the Yamaha YM3812.

Everything described above for programming OPL sound applies to OPLII.

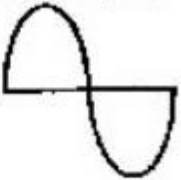
### Additional Feature of OPLII – More Waves!

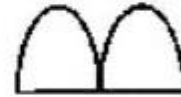
With the YM3812, bits 0 and 1 of Registers E0-E8 can choose between 4 wave forms for each output sound channel compared to the YM3526 which only offered the full sine wave.

D1	D0	Waveform
0	0	
0	1	
1	0	
1	1	

Video Game Music Preservation Foundation wiki page on the YM3812

<http://www.vgmpf.com/Wiki/index.php?title=YM3812>

Yamaha\_YM3812\_Application\_Manual.pdf

<https://archive.org/details/YamahaYM3812ApplicationManual>

### Good News For Us

The Ad Lib Music Synthesizer popularized the use of the YM3812 in the IBM line of personal computers which were widely used by DOS game programmers for much improved game sounds compared to the IBM's built in beeper.

This means we can use the Ad Lib tools like Instrument Maker to create instrument sounds or Visual Composer to create whole songs.

Here's what the Accordion example data looks like in Ad Lib Instrument Maker:

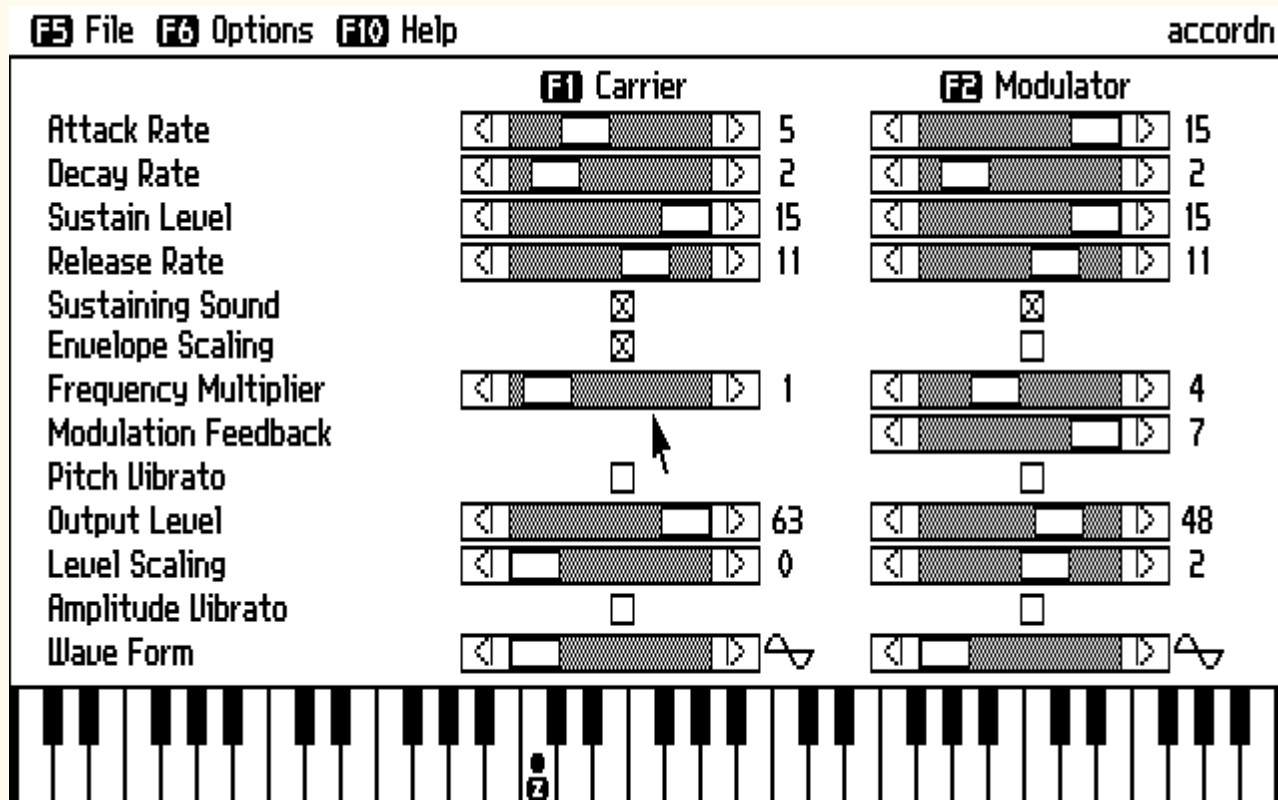

All of the wide world of the Internet's programming information and archived tools for the Adlib are ours to use as well! The DOSBOX emulator easily accommodates providing an emulated Ad Lib synthesizer card and DOS environment to run the original tools on.

AdLib\_Programming\_Guide.pdf

[http://www.vgmpf.com/Wiki/images/4/48/AdLib\\_-\\_Programming\\_Guide.pdf](http://www.vgmpf.com/Wiki/images/4/48/AdLib_-_Programming_Guide.pdf)

ROL Format for Song Data

[https://moddingwiki.shikadi.net/wiki/ROL\\_Format](https://moddingwiki.shikadi.net/wiki/ROL_Format)

BNK Format for Instrument Data

[https://moddingwiki.shikadi.net/wiki/AdLib\\_Instrument\\_Bank\\_Format](https://moddingwiki.shikadi.net/wiki/AdLib_Instrument_Bank_Format)

The DEMO.BAS through DEMO6A.BAS/DEMO6B.BAS in the CoCo Discord (linked above) include BASIC code to decode all

145 of the Ad Lib STANDARD.BNK instrument definitions and play the note scale with them. [#mmmpi-sdc-extender-opl3](https://discord.cocotalk.live)

### 1988 The Yamaha YMF262 (OPL3) – Ad Lib Gold

And now we finally get current with the true synthesizer chip in the MEGAmimi MPI: the Yamaha YMF-262 OPL3. Yamaha again extended the FM Operator-L standard, adding even more features to OPLII.

### Additional Features of OPL3

Perhaps the biggest news for the OPL3 is that it doubles the number of operators from 18 to 36 while remaining backwards compatible with the OPLII and OPL register layout.

This means rhythm channels stay at channels 5-8, and new channels 9+ are more melody.

## The New Register Array

Address (HEX)	REGISTER ARRAY 0 (A1='1')								REGISTER ARRAY 1 (A1='H')									
	D7	D6	D5	D4	D3	D2	D1	D0	D7	D6	D5	D4	D3	D2	D1	D0		
00-01H	LSI TEST								LSI TEST									
02H	TIMER 1																	
03H	TIMER 2																	
04H	RST	MT1	MT2					ST2	ST1	CONNECTION SEL								
05H															NEW2	NEW		
08H	NTS																	
20H-35H	AM	VIB	EGT	KSR	MULT				AM	VIB	EGT	KSR	MULT					
					3	2	1	0					3	2	1	0		
40H-55H	KSL		TL						KSL		TL							
	1	0	L5	L4	L3	L2	L1	L0	1	0	L5	L4	L3	L2	L1	L0		
60H-75H	AR			DR					AR			DR						
	3	2	1	0	3	2	1	0	3	2	1	0	3	2	1	0		
80H-95H	SL			RR					SL			RR						
	3	2	1	0	3	2	1	0	3	2	1	0	3	2	1	0		
A0H-A8H	F NUMBER (L)								F NUMBER (L)									
	F7	F6	F5	F4	F3	F2	F1	F0	F7	F6	F5	F4	F3	F2	F1	F0		
B0H-B8H			KON	BLOCK			FNUM (H)				KON	BLOCK			FNUM (H)			
				B2	B1	B0	F9	F8				B2	B1	B0	F9	F8		
BDH	DAM	DVB	RYT	BD	SD	TOM	TC	HH										
C0H-C8H	CHD	CHC	CHB	CHA	FB		CNT		CHD	CHC	CHB	CHA	FB		CNT			
					2	1	0							2	1	0		
E0H-F5H					WS								WS					
					W2	W1	W0					W2	W1	W0				

The left-hand layout of registers is really the same as OPL and OPLII with a couple of additions. All of the new channels are configured the same way as you've previously seen with the OPL, we just write to 2 additional memory mapped addresses on the CoCo (\$FF52-\$FF53) to select the Register Address in the second (right hand) register array, and move data to and from that.

- \$FF50 Register Array 0 (left side) Register Select (00-F5)
- \$FF51 Register Array 0 Data Read/Write
- \$FF52 Register Array 1 (right side) Register Select (00-F5)
- \$FF53 Register Array 1 Data Read/Write
- \$FF54 YMF262 Reset

Registers C0-C9 also include a simple stereo channel control where you can place a sound channel on the left output, right output, or center (both) outputs.

### 4-Operator Algorithms

OPL3 It also adds 2 new modes with 4-operator algorithms with Feedback.

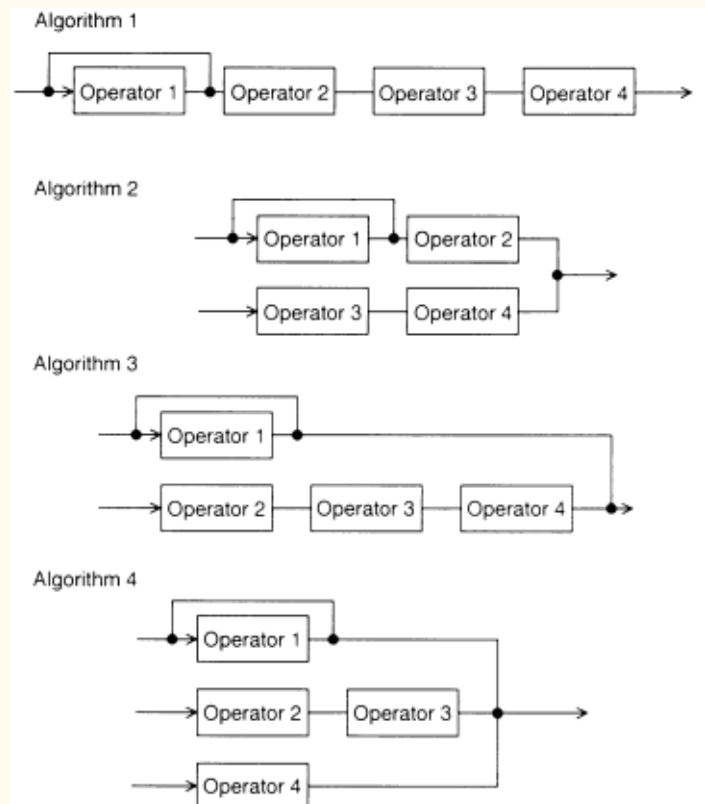

## 4 More Wave forms including Square Waves

Bits 0-2 of Registers E0-E8 now allow a choice of 8 wave forms for each operator.

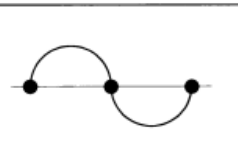
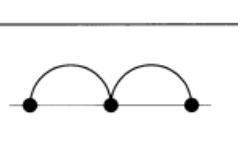
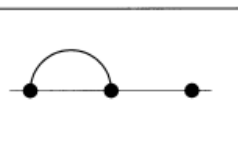
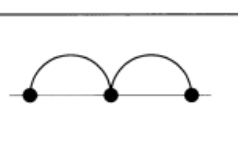
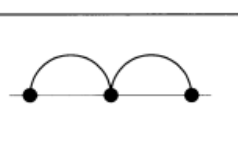
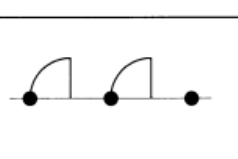
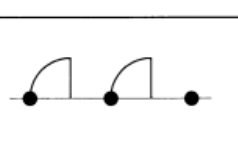
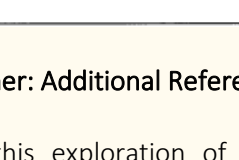
WS=0		WS=4	
WS=1		WS=5	
WS=2		WS=6	
WS=3		WS=7	

### Going Further: Additional References and Things To Do

Hopefully this exploration of the background and initial programming gotchas and how-to provides you a basis to start your own programming of the Yamaha YMF262 in the MEGAmi MPI.

As promised above there is an excellent programming reference that I found indispensable to finally getting my programming going for this chip: the OPL4 Application Manual.

Yamaha kept going, introducing the OPL4 standard (which continued to build on OPL3) and implemented it in the YMF278B, for which Yamaha wrote an excellent Application Manual:

YMF278B Application Manual  
<https://download.file-hunter.com/Manuals/Yamaha%20YMF278B%20OPL4%20Application%20Manual.pdf>

This has become my go-to reference for YMF262 programming... just skip past the new Wave table stuff added

in OPL4. The FM Synthesis core in OPL4 is ... OPL3 as implemented in the YMF262.

Pages 33-56 of the PDF starts with Overview of FM Synthesizer and covers every aspect as completely as you ever need as a reference.

### Zipster Zone

Ed "Zipster" Snider's web log of developing the MEGAmi MPI is worth reading.

<https://thezipsterzone.com/2018/05/09/mega-mini-mpi/>

For assembly language programmers, Zipster provides an excellent example of playing the scale on the YMF262:

Programming the OPL3 Chip with the Color Computer

<https://thezipsterzone.com/2018/12/01/programming-the-opl3-chip-with-the-color-computer/>

Zipster also began working on a "tracker" style music composer, which I hope he will finish or release as source to be finished.

CoCo OPL Composer

<https://thezipsterzone.com/2019/02/01/coco-opl-composer/>

Zipster even built us a chip tune player!

CoCo Chip tunes Player

<https://thezipsterzone.com/2019/02/14/coco-chiptunes-player/>

### NitROS9 Chip Tunes

Todd "LordDragon" Wallace had built a CoCo Chip tune player for NitROS9 which uses the MEGAmi MPI sound:

Updated Coco Chip Tunes Player To Version 1.3:

<https://tektodd.com/category/color-computer/>

### Other References

Programmer's Guide to Yamaha YMF 262/OPL3 FM Music Synthesizer

<http://www.fit.vutbr.cz/~arnost/opl/opl3.html>

# CoCoFEST!

November 6th & 7th, 2021 at  
**Holiday Inn Elk Grove Village, Illinois**  
1000 Busse Road  
Elk Grove Village, IL 60007  
Phone: 847-437-6010 - [Website](#)

## Tickets

Tickets at the door for the entire two-day event are \$15 for the 1st family member, \$10 for the 2nd family member and beyond. Sunday-only tickets are \$10 for the 1st family member, \$5 for the 2nd family member and beyond. Children aged 12 and younger are admitted for free. Pre-registration is encouraged for all visitors to avoid long lines Saturday morning. Pre-registering is required for all vendors.

## Schedule

Vendor set-up Friday the 5th until 9 PM – Saturday 7 to 9 AM  
Public sign-in starts Saturday 8 AM  
Show time Saturday 9 AM to Midnight  
Sunday 9 AM to 3 PM  
Take-down/Clean-up Sunday 3 PM to 5 PM SHARP!

## Food

Catered Dinner on Saturday at 6PM (\$20) if you preregister. We will use the food service of the Holiday Inn. It will be the buffet style, free for children 12 and under, \$20 otherwise. The club is subsidizing the dinner (“list” cost is ~\$48 per person); so don’t pass up this bargain when you preregister! If you register at the door, catered dinner will be \$25 only while spots are available. We expect to run out so make sure you preregister so we have enough food!!

## Booking

You can pre-register at [TandyList](#) or by contacting [Tony Podraza](#) if you cannot register online.

You can also book your room online [by clicking here](#) (before the cut off date of Midnight Chicago time, October 22), for the special CoCoFEST! rate of \$99 a night plus fees and taxes (expected total \$111.87), for a king-sized room. You must select any days between and including the 4th and 7th.

You may alternatively call the Front Desk to book your room at 847-437-6010 and providing the Group Code of CCC or by calling IHG’s Central Reservation Center (877-424-2449), requesting the group rate for CoCoFEST! or referring to the supplied group code of CCC.

For those who have booked rooms, breakfast vouchers can be purchased at the Front Desk for \$10.00 per person, per day, for Shelby Campbell’s Restaurant on site.

The Holiday Inn Elk Grove will continue to accept reservations after October 22, subject to availability.

Shuttle service is offered by the Holiday Inn Elk Grove using their Local Shuttle and Airport Shuttle, with both vehicles having a maximum fourteen (14) passenger capacity. Local Shuttle service only travels within a five (5) mile radius and is on a first come, first serve basis, with trips booked based on availability, with multiple trips if needed. The Airport Shuttle is available for O’Hare International Airport [ORD] ONLY and runs every day between the hours of 5:00am and 12:00am, Midnight, local hotel time. Should either shuttle service not be available at the required time needed or if you are flying in or out of Midway International Airport [MDW], you are responsible for arranging your own transportation which the Hotel can assist in arranging. Contact the hotel for more details and to reserve/verify a spot.

Due to the ongoing pandemic worldwide, some services provided to guests described above may change, be cancelled, or may not be offered. Please call ahead to verify any plans, prices, services, etc.

## Operating System Nine

### 'Das Boot' – by Rick Ulland

Last issue, we introduced the three primary ways to config the OS9 operating system- startup, env.file, and OS9Boot. The first two are standard stuff- a list of things to load or do at startup, and a list of settings to apply. Then we have OS9boot, a collection of OS pieces. You might wonder, why isn't that just another list?

In short, it's the hardware. We start small - the CoCo3 only guarantees 128K total RAM, maybe 512K. And then get smaller - the 6x09 CPU can only see 64K at a time. Large enough to hold a carefully crafted OS, but not large enough to include a snazzy OS9 builder and configurator.

Once the OS is loaded our horizons expand, thanks to the GIMEs bag of tricks. First, it can build a virtual 64K window from 8K blocks scattered all around the physical RAM. And best, it has two of those windows and can rapidly switch between them. So original ECB has to load everything in 64K, but SECB is able to use the entire 64 for code, and the entire 64K for graphics. Making 128K the minimum size.

Like the original ECB, OS9 Level One is limited to the CPUs native 64K space, but with a wrinkle. To allow multiprogramming, program code is loaded as separate modules, each being fit into a number of 256 byte pages. This leaves a tiny bit of wasted space at the end, but only for now. When the process is done, those pages can be freed up for reuse. Except for one small problem - code cannot be broken up. Each process must be loaded into sequential pages start to finish. Imagine 3 programs have been loaded, leaving unused space after the last one. User drops program 2 and tries to load a different program that is slightly larger, but small enough to fit in the total RAM available. Will it fit? Maybe not. Program 3 is splitting the available RAM into two sections.

When the CoCo3 came out, there was an expanded OS9 available, OS9 Level Two. It will use an MMU to map different areas of physical RAM into the virtual 64K the 6x09 can see, theoretically avoiding the fragmentation issue Lvl1 faces. There is, of course, a new problem. Inside a single process OS9 may have 256-byte pages, but the whole process has to be loaded into MMU size chunks - a rather large 8K in the case of the GIME. In MMU math,  $8K + 1 \text{ byte} = 16K$ . With only 8 of these pages in view at one time, this is something to plan around.

The pmap command displays the MMUs ability, 8K pages. My CoCo3 says the SYSTEM process has used up 7 of the 8 blocks available, leaving one block, or 8K free. That might as well be

zero, some system utilities will need to map into this space and according to MMU math that last block is it.

In contrast the smap command shows OS9s internal assignments, in 256 byte pages. On a CoCo3 one MMU block in pmap is two whole lines of smap, or 32 pages. And sure enough my CoCo3 displays the two empty lines we don't want to touch, but also reveals a little bit of pocket change pmap doesn't see. There are 12 pages available before grabbing that last MMU block. A couple three pages have been stranded and might not be useful, but we are looking at close to... 3K.

NitROS9 has obviously filled the available RAM as efficiently as possible. Just loading in more stuff would negate that. So lets jump into the rabbit hole.

The DOS command built into DECB loads a single disk track, then executes it. In this track, OS9 crams the start of a kernel, a simple boot screen driver, and a dedicated boot loader that can read one device - a floppy, hard disk, SDC card, drivewire... whatever the rest of OS9 is stored on.

Then we load the real OS, in the form of an OS9Boot file. With only a simple bootloader to read it, and a small yet complicated area to store it, OS9Boot cannot be auto-assembled on the fly. It has to be prepared ahead of time. So we need to know about the list of pieces parts.

We get the boot track by default, and the first user spec items come easy. We always need the rest of the kernel (krnp2) and its startup data (init). There is a low level error handler and reporter (krnp3) that is nice to have. Finally, we will need a way to connect this inner core to everything hardware, in the form of the head manager IOMan.

This group can be thought of as the front office. And if you've ever been near a front office, you know those guys don't go out in the plant to deal with low level worker bees like disk drivers. We are going to need some middle management.

Branching out from IOMan, the first of the middle managers is RBFMan. Random block files would be disk sectors or anything else that exists as separately addressable blocks of data.

Next is SCFMan. Sequential character files are any serial data stream from an actual serial port to keyboards, text screens and sound cards.

Finally, we have PipeMan, which handles communication between processes (programs). This might not sound

important at first, but turns out to be awfully handy when each process has to fit in 64K.

Low level drivers will need to be listed immediately under their manager, and below each of them is a number of hardware descriptors explaining each device the driver can handle.

This tree structure of managers containing drivers containing descriptors is awfully handy on a small computer. For special purpose boots, you are free saw off any parts you do not need, from the smallest device descriptor up to and including one of the middle managers.

If you are using NitrOS9 Ease of Use (and you should be) each of these managers, the drivers it controls and the descriptors those rely on are detailed in the file `/dd/MODULES/NitrOS9_L2_BootFile_Dependacy_Tree.txt`. Or to have a look at the current boot, with all the bits listed in order, run this:

```
ident -s /dd/OS9Boot
```

Do you even need to know this stuff? Maybe not. Ease of Use does manage to do a little auto-config despite the Coco's limitations, a standard desktop probably works fine. And there have always been alternative ways to make minor changes.

For example, you could load a new driver and descriptor in the startup file. Or you could run a utility like `xmode` to change an existing descriptor on the fly. Or hand tweak a running system, then write a new boot disk. For that last option all you need is the `cobbler` utility. A `cobbler` makes boots. It does not design new boots. It does not check the fit. It hammers out a boot track and load file exactly like the live boot it is running under.

On a real floppy drive, you would not use the current boot disk. There is a chance `cobbler` could delete the current OS9boot file, fragment the new one, and brick the disk. The safe thing to do is run `cobbler` on a newly formatted floppy disk then use `dsave` to copy the rest of the files from the original boot floppy. Everything gets defragmented, and having both copies has saved my butt more than a few times!

```
cobbler /d1
```

```
dsave /dd /d1 ! shell
```

If `/dd` is a hard drive image like the EOU image, the first way would still work, but `dsave` will be running for a while. Instead copy the entire VHD file to a new name, mount that as `/d1`, and skip the `dsave` step.

More complex changes were originally done with OS9gen. There are more capable replacements like `KwikGen` but lets start at the beginning. As with `cobbler`, it's best to do this on a copy, not your current boot image.

To add a driver to your boot while keeping all of the existing stuff, start `os9gen`, feed it the current `os9boot` file, and follow that with the files containing a new driver and its descriptor(s). End the list with the ESC key. For example, to add a Deluxe RS232 you might run this:

```
os9gen /d1
/d0/OS9Boot
/dd/MODULES/6309L2/MODULES/SCF/sc6551.dr
/dd/MODULES/6309L2/MODULES/SCF/t2_sc6551
.dd
[ESC]
```

I'm not totally a fan of this idea, I like to load things in order. To make a totally new boot, `cd` to `/dd/MODULES` and have a look at `/dd/MODULES/EOU_special_notes.txt` for luck. Now copy the list of everything EOU provides to a work file:

```
cd /dd/MODULES
copy filelist6309.txt bootlist.txt
tmode pause
ident -s /dd/OS9Boot
```

Now you can open an editor in another window and compare `bootlist.txt` with the contents of your current boot file, as provided by `ident`. Delete everything you don't need, and add the full path to any third-party drivers under the proper manager. Finally, mount your boot image copy as `/d1` and feed the whole thing to `os9gen`:

```
cd /dd/MODULES
os9gen /d1<bootlist.txt
```

Enough of this. Next time, we actually do stuff.





## CoCo News!

Curated by L. Curtis Boyle

Cherry picked by:

R. Allen Murphey

Tim Lindner & Salvador Garcia

### CoCo Digital Video New PCBs

Alan of AC's 8-Bit Zone showed his first tests of prototype CoCo 1 and 2 digital video output boards for direct to DVI output and more with no analog signal processing circuitry:

[YouTube link](#)



### Zero Hour

Nick Marentes put up his 2nd blog entry for his new game called Zero Hour:

[Blog link](#)



### Card Deck Demo

Paul Shoemaker put up a graphics demo of some playing card designs that he has running with a machine language subroutine for a CoCo 1/2, and is thinking of porting some of his CoCo 3 card games back to the CoCo 1/2 with this engine:

[Facebook link](#). He then did a further update, redesigning the deck slightly, and played around with different speeds of display: [Facebook link](#)



### Semigraphics Fighters

Erico Patricio Monteiro put up an animated GIF demo on Facebook showing 6 sets of moves for his upcoming semigraphics fighter game (not shown at actual speed, but greatly sped up): [Facebook link](#)

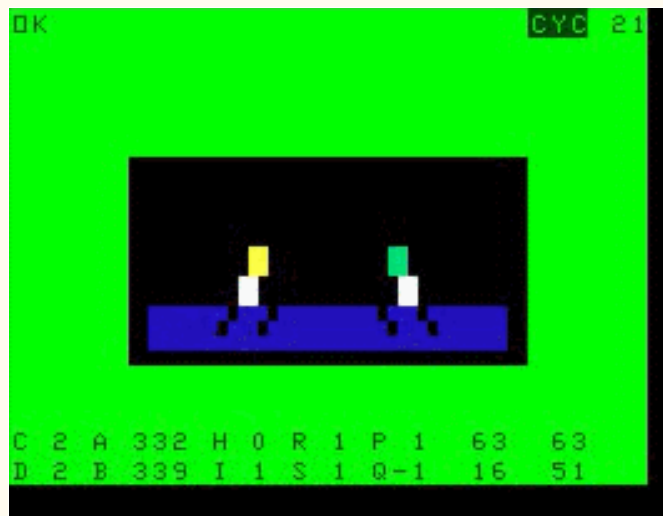

## Dropship

Darren Ottery put up a cool video showing his new MC-10 game "Dropship" (which requires an MCX-32, for fast loading the screens) (Note: he has a spoiler video in the comments showing the end of the game, too): [Facebook link](#)



## Closeout

Jim Gerrie has ported and extended another old game to the MC-10, this time Closeout, based partially on the original Vic-20 version from COMPUTE! magazine from March 1983: [YouTube link](#)

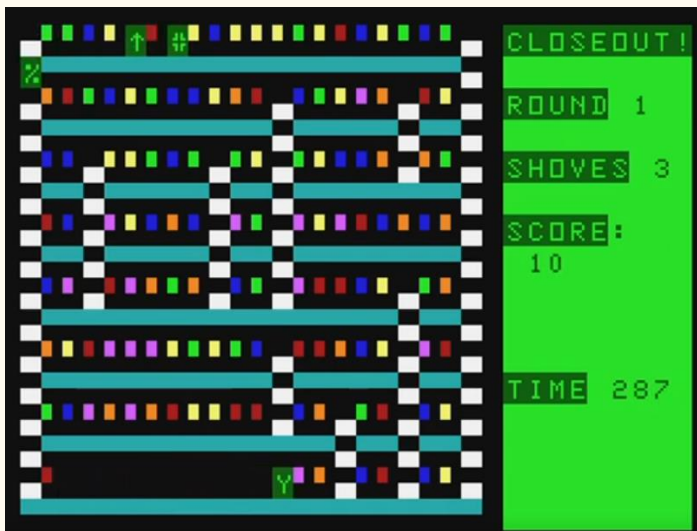

## COCO SCROLLER

Ciaran Anscomb posted a demo download (compatible even down to a 4K CoCo 1!), showing a hardware scrolling trick on the VDG (works with Dragons or CoCo's): [download link](#)

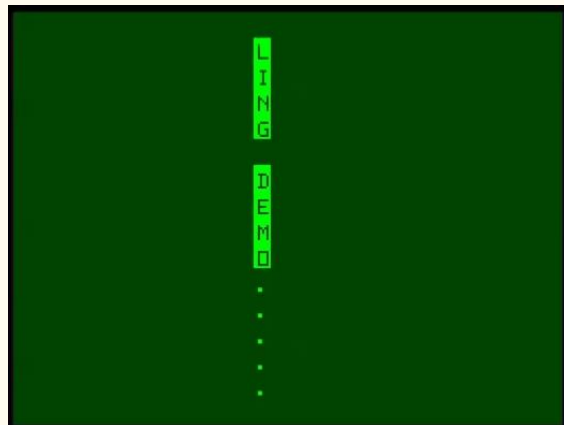

(Screenshot of Ciaran's scrolling demo)

## GIME-X IN THE WILD

John Laury is one of the people to get in on Ed Sniders "early release" versions of the GIME-X with 8 MB RAM board (he also got a 6309 & CocoMech keyboard), and he posted a bunch of pictures of it for people to check out what the release versions look like in the wild: [Facebook link](#)



## MRDAVE6309 ROMPAK

"This new ROM pak lets you load 32k size games thru a normally 16k cart if you're using a coco1 or 2, also works for coco3 bank switching and lights are hooked up to SCS line so it's easy to use" The boards are available thru Dave. \$10 as a kit with EPROM and chips. You can catch Mr. Dave on the [CoCo Discord](#) server as "MrDave6309"

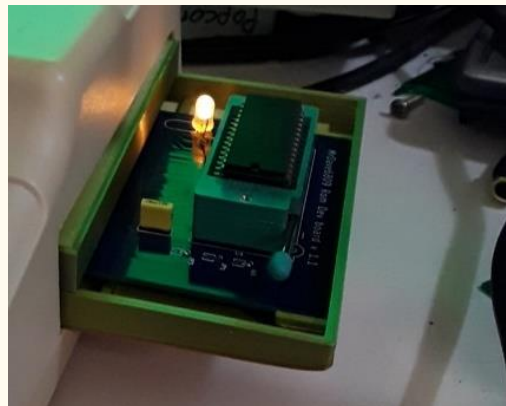

### CP400 JOYSTICK

Ermani Cioffi posted a video demonstrating his new CoCo / CP400 joystick, that uses an Arduino, and also supports 2 buttons for the CoCo 3. Google Translate of his YouTube description says:

"This is the new joystick for CP400 and Color Computer. It has 2 buttons, which can be used with Coco3 games. Using an Arduino analog, just like PS2, is much more accurate. Are you interested? Talk to me." [YouTube link](#)



### MC10 MCX32 EDITOR

Robert Sieg has released a video & download of the start of his high res editor for the MC-10 MCX32. It shows the whole 128x96x4 screen, and lets you edit it in 32x16 chunks, using the regular semigraphics mode to show the "zoomed" in bits: [Facebook link](#) | [Download link](#)

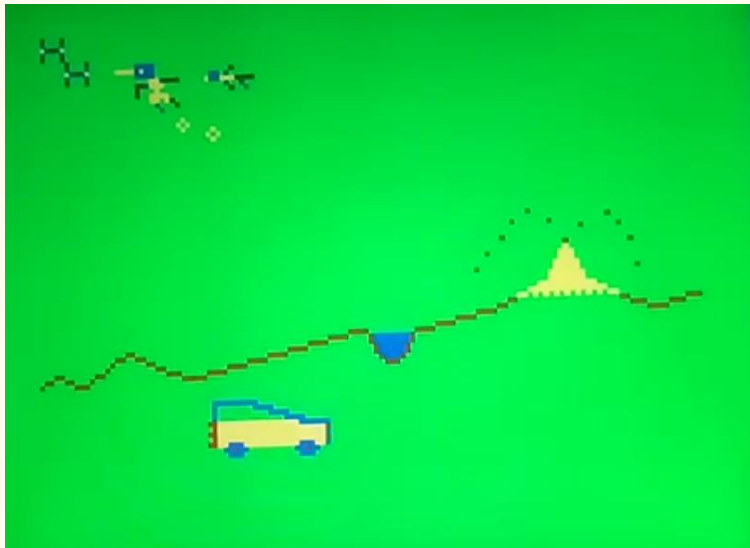

### JOGOS 80

Erico Patricio Monteiro, who has been working on the Semigraphics-4 fighting game, had the game in progress featured on the cover of Brazilian retro magazine, "Jogos 80": [Facebook link](#)



### GALAXY JAILBREAK

Jim Gerrie has released a beta of "Galaxy Jailbreak" for the MC-10, based on the Sinclair ZX-81 original, but is using the new MC-10 BASIC compiler by Greg Dionne (actually, he released 3 updates as the week went on; this is the latest one): [YouTube link](#)



He has also produced a 15 minute "Medly" video of games for the MC-10 that he now has compiled BASIC versions of (And a link in the description of where to get these games): [YouTube link](#)

(This includes: Galaxy Jailbreak, Alpha Force, Closeout, Defcon1, Coloroid, MC Lode Runner, Q\*Bert, MC-Scramble and Swell Foop)

### ZERO HOUR #3

Nick Marentes has posted his 3rd chapter to his CoCo 3 game in development, showing off his animated backgrounds in a video (If we used this in a game on segment with Nick explaining it, throw in the "Extra" story of the accidental shaking cogs that looked better than the intended smooth original): [Blog link](#)

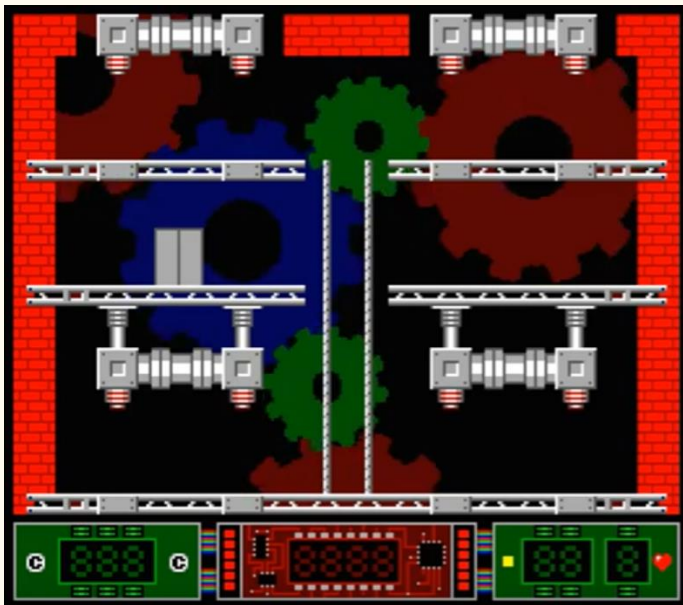

### GRAPHICS SPLITS

Simon Jonassen put up a couple of screen shots showing a teaser to a demo he is working on, showing 32 graphics mode splits per 2 scan lines: [Facebook link 1](#)



And then a video showing mixed modes, with smooth offsetting by scanline: [Facebook link 2](#)

### COCO CGA

Trey Tomes has put up a download on his github for the entire CGA character set, that you can use in your own programs. This has the full 256 character set (Todd Wallace's NitrOS9 one, included in EOU, has 224 characters from CHR\$(32) to CHR\$(255)): [Facebook link](#)

Download ASM source code for the full character set: [github link](#)

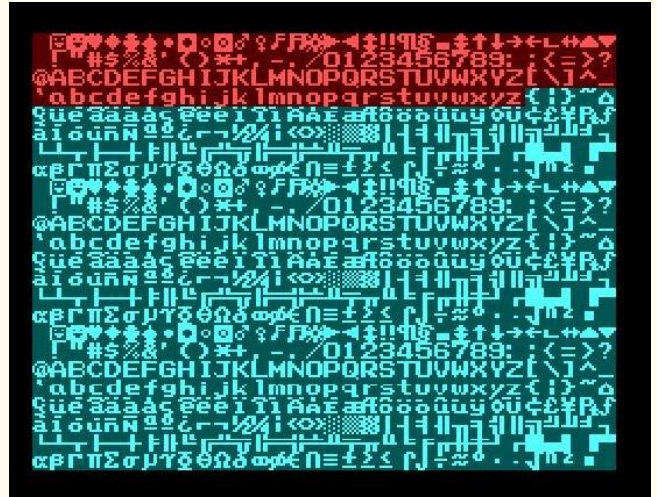

### OS9 AWK

Walter Zambotti has released his port of the V7/32V version of Unix AWK to NitrOS-9. It took some effort to get it to run in a 64K workspace, so this requires Level II OS-9/NitrOS-9 (won't work on level 1). Link to his Github to get the sourcecode is also in the post: [Facebook link](#)

```
<Term!02>/DD:cd user/c/awk
<Term!02>/DD/USER/C/AWK:list testawk
awk '/manager/{print$1,$4}' employees
<Term!02>/DD/USER/C/AWK:list employees
ajay manager account 45000
sunil clerk account 25000
varun manager sales 50000
amit manager account 47000
tarun peon sales 15000
deepak clerk sales 23000
sunil peon sales 13000
satvik director purchase 80000
<Term!02>/DD/USER/C/AWK:testawk
ajay 45000
varun 50000
amit 47000
<Term!02>/DD/USER/C/AWK:█
```

## CALL FOR SPEAKERS

Tandy Assembly is looking for speakers for this October's show in Springfield, Ohio. You can read the guidelines and email the link provided here: [web link](#)

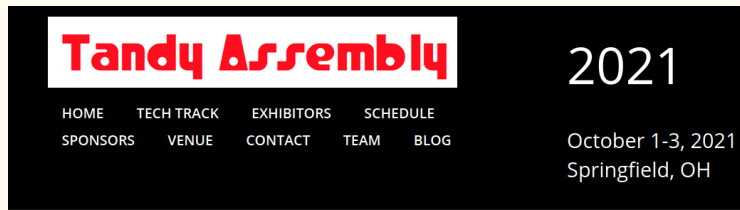

CALL FOR SPEAKERS!

## COCO MOTHERBOARD

Rocky Hill on YouTube put up a video showing his receiving of some clone boards of a CoCo 2 that he ordered to make sure a KiCad schematic works properly, as part of the Bit-Preserve project. For a first revision board, it required surprisingly few fixes, and works well enough to run Mega Bug and use a joystick: [YouTube link](#)



## THE SOLAR SYSTEM

Michael Pittsley has uploaded an almost 30 minute video showing the CoCo program (with audio on the cassette) for the Radio Shack Talk/Tutor educational program, "The Solar System: Featuring the Discovery of the Planet Pluto", which includes the real voice of Clyde Tombaugh (starting at 17:35), who discovered Pluto in 1930: [YouTube link](#)



## MC10 TP10 BANNERS

Jim McClellan has started working on an MC-10 banner maker (including showing a sample from his TP-10 thermal printer) on the MC-10 Facebook page: [Facebook link](#)



## ALICE 90

"retrolimber 2018" on YouTube put up this Italian video of the French Alice 90 computer, which was the successor to the Alice (an MC-10 clone) that came out in 1985. It has improvements, though - including 32K RAM onboard and a full keyboard. It also had 8K allocatable for video RAM, which means that it should be able to handle PMODE 3 and 4 graphics fine as well (unlike the stock MC-10, which can only use up to 4K for video RAM): [YouTube link](#)



## POKER SQUARES



Paul Shoemaker posted a couple of videos showing his porting his Poker Squares game back from the CoCo 3 to the CoCo 1/2 (and thanks Simon Jonassen for helping track down an insidious bug): [Facebook link](#)

And on Friday, he released it in our Discord, in the general-game-posts channel. It should be up on the Color Computer Archive soon. He has also started working on a CocoVGA version; his first screenshot of imported cards from the CoCo 3 is on Facebook: [Facebook link](#)

### TREASURE ISLAND DEFENCE

Sheldon MacDonald has now started rolling out his new CoCo 3 and CoCo 1/2 with CocoVGA game, Treasure Island Defence. The game will come on the Game MAster ROM cartridge and fully utilizes the sound chip on the card, as well as 16 color graphics on a CoCo 1/2 with the CocoVGA (and the ROM double speed that putting the game on a cartridge allows). The cartridge will be \$20 USD, plus shipping. You can also request the source code from Sheldon as well. It is possible to run it off of disk, but it won't have sound. He showed a picture of the the complete "kit" to show how it is constructed, and what is included, on the CoCo group on [Facebook link](#)



He also put up a video showing it running from Ed Snider's PSG sound card now as well (note the PSG has to be in slot 1). He notes that notes sound "darker" on the PSG vs. the GMC, and compares the two in the video: [Facebook link](#)



### MINES+



Fabrizio Caruso placed 2nd in the PUR-120 category of the 10 liner BASIC programming contest, with his MC-10 game Mines+. He has a video demo of the game in the MC-10 group on Facebook: [Facebook link](#)

You can download the game in .C10 here: [Github link](#)

### COLOR TOWN OF ZZT

Trey Tomes put up a screenshot of a PC to CoCo 3 game conversion he is working on (using the extended IBM ANSI character set), which was called "Town of ZZT" on the PC: [Facebook link](#)

He also put up some screenshots of level mockups: [Facebook link](#)



## MC10 MCX32 MARIO

Robert Sieg put up some animation cels with Mario for the MC-10 (Created on an MC-10 with the MCX-32): [Facebook link](#)

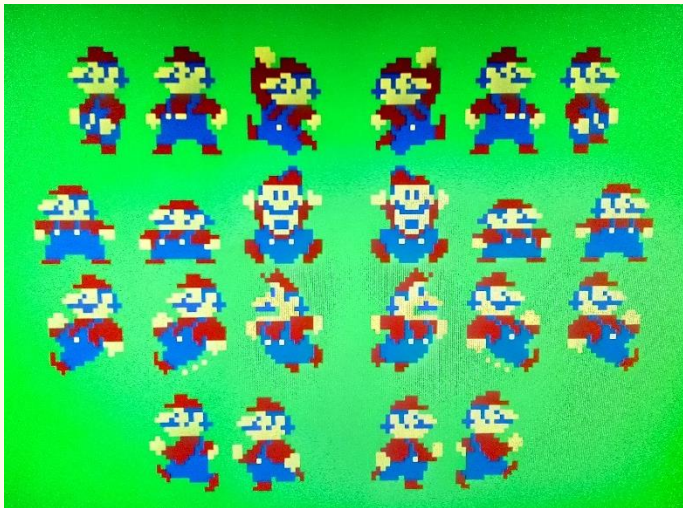

## ZERO HOUR #4

Nick Marentes has posted his 4th chapter in his Zero Hour development blog - this time covering sound effects & his "ambient" sound in the background that goes along with the animated cogs he showed in the previous episode: [Blog link](#)



## DUNJUNZ ANNIVERSARY EDITION

Sixxie (Ciaran Anscomb, author of XRoar) put up a video showing the Anniversary Edition of his Dunjunz port to the CoCo or Dragon (which includes the multi-voice soundtrack on the title screen if you have 64K): [YouTube link](#)

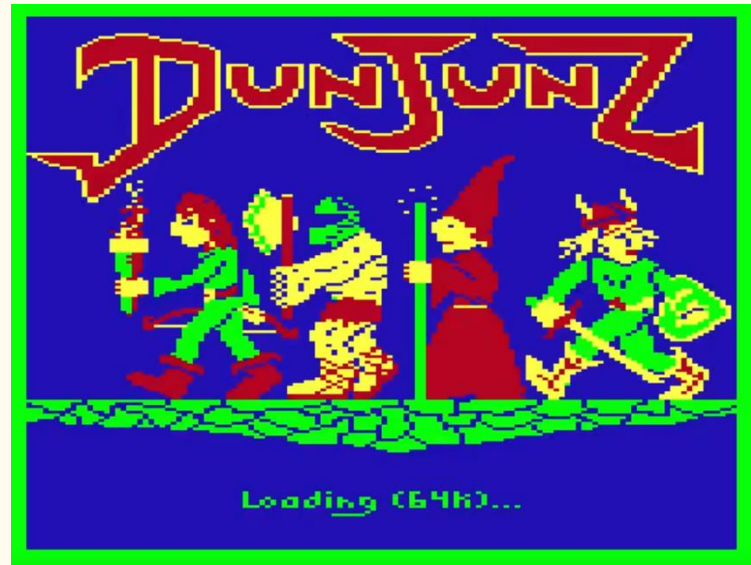

## COCO3 WEB SURFING

Henry Rietveld put up a video showing his CoCo 3 surfing the web through Action Retro's "Frog Find" search engine (made for vintage computers). I believe he is logging the CoCo onto a host PC via VT-52 or VT-100 emulation, and going through that way (similar to Lynx): [YouTube link](#)

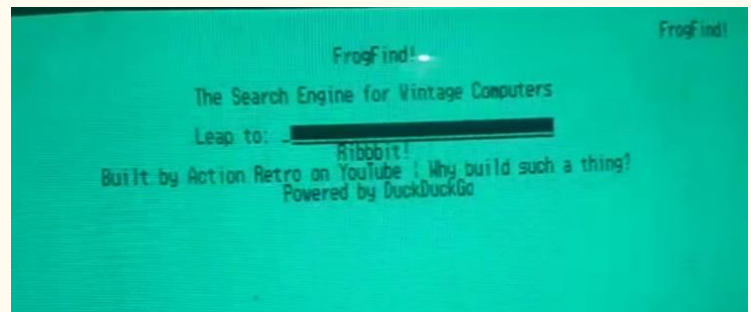

## MORE VDG HARDWARE SCROLLING

Simon Jonassen has posted his next version of VDG hardware scrolling tricks, this time with a screen split text screen. Precise timing is still being worked on, so it's got a few visual glitches, but it's working: [Facebook link](#)



## GIME SCROLLING SHENANIGANS

John Laury posted a CoCo 3 only response video to Simon's, doing a similar trick but using the much easier to use GIME registers on the CoCo 3: [Facebook link](#)



## COCO3 512K IN THE UK

For any UK or European listeners who may have managed to pick up a 128k CoCo 3 over the years, Ciaran Anscorb (author of XRoar, Dunjuz and other things) has made some prototype 512k upgrade boards. He has one installed and tested and working, so he doesn't need the other prototype, so he is selling a few extras, which should mean much cheaper shipping than ordering from the USA. The board is £17.50, plus shipping (which varies depending on options): [web link](#)

### CoCo 3 512K SRAM upgrade

Working prototypes. There was a minimum PCB order, so these are my spares offered at little more than cost price. Hand soldered - don't expect them to look super professional, but they've been tested as working on my PAL CoCo 3!

As described here: <https://gitlab.com/sixie/cc3-512k>.

2 boards available (I probably do have the bits to solder up a third if there are really that many people that want one). Base price £17.50, so total price incl. shipping:

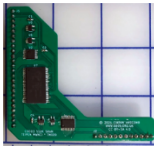

UK	UK Standard 1st Class	£18.79	£19.63
	UK Standard 2nd Class	£18.46	£19.30
	UK Tracked 48 w/ Signature	£21.94	£22.88
USA	International Tracked & Signed	£27.05	£28.68
	Australia International Tracked & Signed	£27.10	£28.73

## SS-50 COLOR CONNECTION

Carlos Camacho found an interesting ad from a 1981 6809 magazine (before any CoCo dedicated magazines came out, and within a year of the CoCo being released), of a hardware adapter called the "Color Connection". This was an SS-50 bus adapter card, and could optionally allow RAM expansion of up to 48K (this was back when Radio Shack only offered 4 or 16K), as well as allowing hooking up of various SS-50 cards. (SS-50 was a common expansion bus on early 8 bits' from around the mid-1970's to mid-1980's). Some other cards that were available were 80 column cards, disks drives (a full year before Tandy offered them), and a 7-slot expansion interface.

## Facebook link

**Introducing the COLOR CONNECTION™**  
**Plug A TRS-80\* Color Computer into the World of System-50™ Computing.**

Now you can expand Tandy's exciting new TRS-80\* Color Computer using proven System-50 products. Expansion possibilities are limitless. And expansion is easy. Plug one end of the COLOR CONNECTION into the Program Pak\* connector of the Color Computer. Plug the other end into a System-50 bus motherboard. Now add the functions you want, selecting from an inventory of standard modules manufactured by competent, long-established firms — from the inventory of solid performers, like Percom Data Company.

**Mini-disk storage — today!**  
 Available off-the-shelf for your extended system is Percom's field-proven LFD mini-disk system. The first choice of knowledgeable 680X computerists since 1977, Percom LFD mini-disk systems come complete, ready to plug in and run. File storage capacities range from 102 Kbytes for a one-drive LFD-400™ system to almost 0.6 Mbyte for a three-drive LFD-800™ system.

**Get serious!**  
 For serious computing like word processing add the Percom ELECTRIC WINDOW™. This memory-mapped video display card features instant display updating, software-defined full display formatting — up to 80 characters by 24 lines, an extendable character generator that generates fully-formed upper and lower case characters, and more. The ELECTRIC WINDOW provides either composite or separate sync-video output, and interfaces a standard black-&-white video display monitor.

**Beyond 16K**  
 Another option is incremental memory expansion. Add 8-, 16- or 24-Kbytes of static RAM with our M24SS card; 16-, 32- or 48-Kbytes of dynamic RAM with our M48DSS card. The COLOR CONNECTION prevents contention between internal computer memory and external memory.

**System Requirements**  
 The COLOR CONNECTION interfaces a TRS-80\* Color Computer to a System-50 bus motherboard. Power for the COLOR CONNECTION is obtained from the computer. Power for the extended bus cards must be provided by an external source, such as Percom's System-50 Power Supply. The COLOR CONNECTION provides for disabling the computer internal memory at 8-Kbyte boundaries to prevent contention with external memory.

**The right motherboard**  
 Fast mini-disk storage, full-format alphanumeric and memory add-on are obvious expansion possibilities. The optional Percom System-50 Motherboard allows you to consider the less obvious. This seven-slot motherboard not only can be self-extended, but also can be extended with our 30-pin I/O motherboard. The richness of readily available peripheral interface cards provides an uncommon degree of expansion flexibility.

The System-50 (SS-50) bus community. With a TRS-80\* Color Computer and the COLOR CONNECTION, it's your world. Enjoy!

**The COLOR CONNECTION..... \$99.95**

## COMPOSITE BEFORE AND AFTER

Riz Thomas on Facebook did a composite upgrade to his CoCo 2, based on AC's 8 Bit Zone (Alan) video that we highlighted a few months back. He has before and after results posted... big improvement! [Facebook link](#)





## DMP-105 AND MULTI-PAK UNBOXING

Catherine Trudel posted photos of her unboxing a DMP-105 dot matrix printer, which is in very good shape: [link 1](#). She also unboxed a later generation MultiPak: [link 2](#)



## DIY CARTRIDGE DEMOS

8 Bits in the Basement put up a video of what he is doing with Mark J. Blair's cartridge PCB (which he designed back in 2013). He shows to set one up, and shows some demos (including mounting the board inside the CoCo, freeing the cartridge port itself: [YouTube link](#))

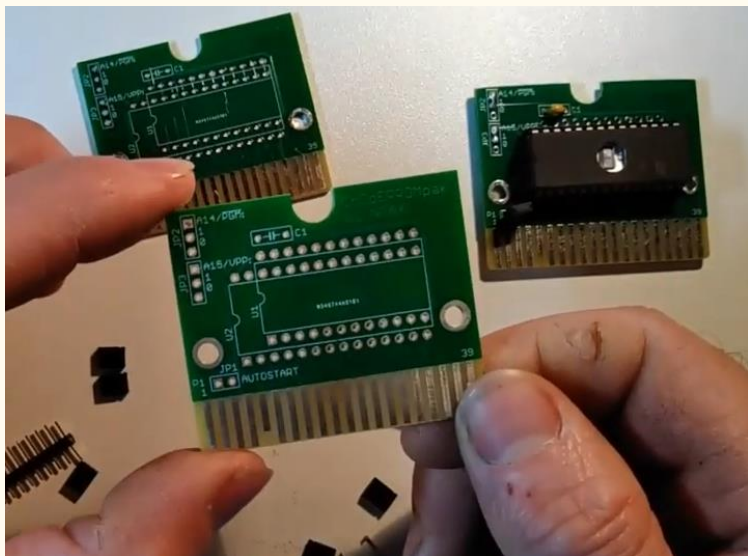

## COCO2 CLONE MOTHERBOARD TESTING



Rocky Hill put up a couple of follow-up videos showing his testing of the serial and cassette ports on his motherboard: Cassette (also tests the joystick). It did I/O error, but loaded enough to run. It plays, but loses the artifact colors (maybe a color burst issue, he speculates). Joystick works well, though: [YouTube link](#). Serial: [YouTube link](#)

## VIRTUAL SPRING FEST

Glenside Color Computer Club hosted a virtual Spring Fest which was a chance for folks to gather during the time CoCoFEST! Would have happened before COVID, this gathering took place using their BlueJeans conferencing service. Replays available on [Facebook](#) and [YouTube part 1](#) [YouTube part 2](#)

Glenside Color Computer Club MEETINGS CALENDAR INFORMATION

Search ...

Glenside Virtual Spring Fest!  
Saturday April 24,  
2021 @ 7:00 PM CDT

Posted on April 20, 2021 | by Jim Brain

Mailing List

## MCX-32 BASIC UPDATE 3.1

Darren Atkinson has released an update to the MCX-32 BASIC (now to version 3.1), which fixes a variety of bugs in the new enhanced BASIC for the MC-10, and some specific to the Alice 32 and Alice 90 machines as well (including fixing the tone values for the PLAY command, since these later Alice's run at 1.00 MHz, not 0.895MHz like the original Alice and MC-10 did). It also enhances the RENUM utility. (Link to download is in the right column): [Website link](#)

MCX Wares

April 16, 2021

MCX Basic 3.1 Update

Version 3.1 of MCX Basic is now available for download. This update is mainly to fix bugs that have been reported with version 3.0.

Use the link on the right side of the window to download the installer.

Changes in MCX Basic 3.1:

Links

- User's Guide
- MCX Basic 3.1 Update

Blog Archive

- 2021 (2)
  - April (1)
    - MCX Basic 3.1 Update
  - January (1)
- 2020 (8)

## ITTY BITTY BANNER MAKER

Jim McClellan has released version of his Itty Bitty Banner Maker for an MC-10 with a TP-10 (and it requires an MCX32-SD). Currently it allows a 64 character banner with alphanumeric and an exclamation point (more to come). He

has the download available, and also shows a sample in the MC-19 Facebook group: [Facebook link](#), [Download link](#)



### NITROS9 LEVEL 1 FOR DRAGON PLUS BOARD

Felipe (CoCo Demus) has released a special NitrOS-9 Level 1 for the Dragon Plus board (for either Dragon 32 or Dragon 64 computers). It supports native 80x24 hardware text screens (and saves RAM for level 1, since that 2K of text is from outside NitrOS-9's 64K), and also supports the extra 64K RAM on the Dragon Plus as a 64K RAM drive. Details and screenshots of it in action: [World of Dragon link](#), [Download link](#)

```
Dragon Plus
(C) 2014 The NitrOS-9 Project
** DEVELOPMENT BUILD **
** NOT FOR DISTRIBUTION! **
Sat Apr 17 09:58:49 2021
http://www.nitros9.org

* Welcome to NitrOS-9 Level 1 *

      yyyy/mm/dd hh:mm:ss
Time ?
April 17, 2021 09:59:10

Shell

OS9:vinit
```

### XROAR TAPE LOADING ENHANCEMENT

Ciaran has an update to XRoar that allows some tapes to load properly now (if they had some faint ghosting/echoing in the background, as he found on a commercial Galagon tape). [Facebook link](#), [Download link](#) (version 0.36.6448) for Windows 32 and 64 versions with this update.

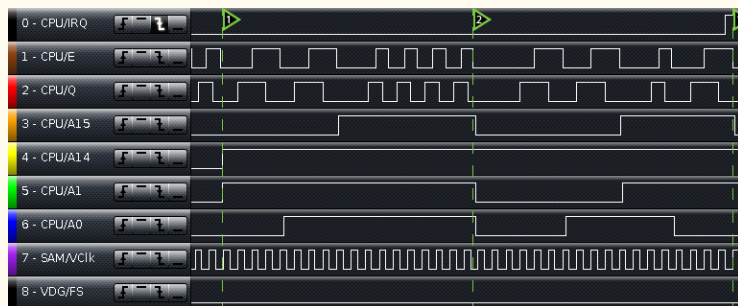

### DRAGON / COCO MYSTERY HARDWARE

Philippe Hennebert posted some pictures of Dragon/CoCo related stuff he has found while digging out his old stuff, and came across a couple of hardware bits that he doesn't remember: [Facebook link](#)



## DOGS AND DRAGONS

David F. Gisbert posted a picture of his dog - who is obviously a huge Dragon fan: [Facebook link](#)

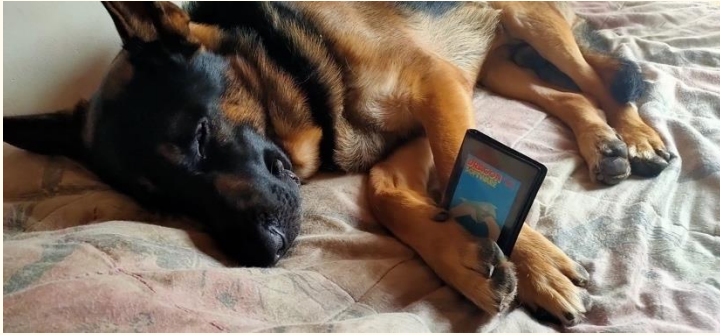

## COCOVGA POKER SQUARES

Paul Shoemaker has put up a video showing his early efforts on his upcoming CocoVGA version of Poker Squares. For this version, he is working on some animated cards, which are shown in the video: [Facebook link](#)



## SEMIGRAPHSICS FIGHTING MAGIC

Erico Monteiro posted a live dev video on YouTube showing some actual test game play for his upcoming SG4 fighting game in BASIC, using his amazing animations: [YouTube link](#)

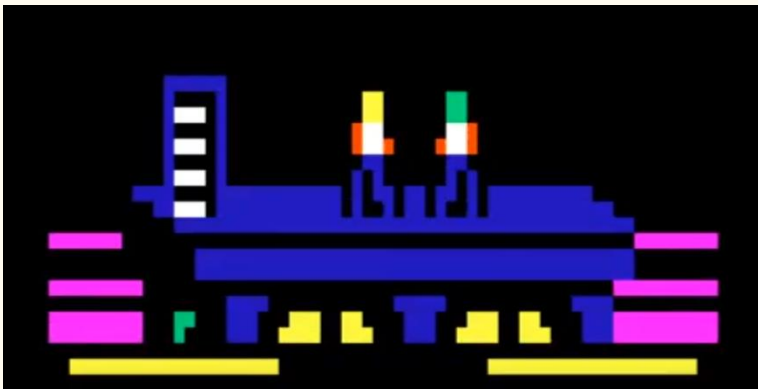

## CUTHBERT DRAGON NEW VIDEOS

Cuthbert Dragon has started putting up Dragon game videos again (on real hardware). Most we have seen before, but a few are uncommon to the CoCo: Guardian Angel, Mission Attack, Laser Run. [YouTube link](#)



Dragon 32 Guardian Angel

9 views • 1 week ago

Dragon 32 Mission Attack

12 views • 1 week ago

## MC-10 MAHJONG UPDATES

Jim Gerrie has released a slightly updated version of his MC-10 Mahjong game, and has a question for viewers/players - he has the tone of the select & match sounds go up as the number of tiles left in play goes down; he is wondering if that works, or should it just be fixed tones? [YouTube link](#)



## TREASURE ISLAND DEFENCE SUPPORTS COCOVGA



Brendan Donahoe has received his cartridge of Treasure Island Defence from Sheldon MacDonald, which is the first game cartridge for the CoCo ever that supports the CoCo 1/2 16

color mode with the CoCoVGA (that Brendan designed and sells), and also uses a GMC board with built in sound chip. Brendan has some pictures and comments on the package. [Facebook link](#)

### TIM LINDNER VERSUS ARKANOID ROUND ONE

Tim Lindner, who is the most active CoCo contributor to the MAME CoCo cores, apparently took a bit of a break to record a couple of gameplay videos, playing the official Arkanoid and showing it in both CoCo 1/2 and CoCo 3 modes: CoCo 3: [YouTube link](#) CoCo 1/2: [YouTube link](#)

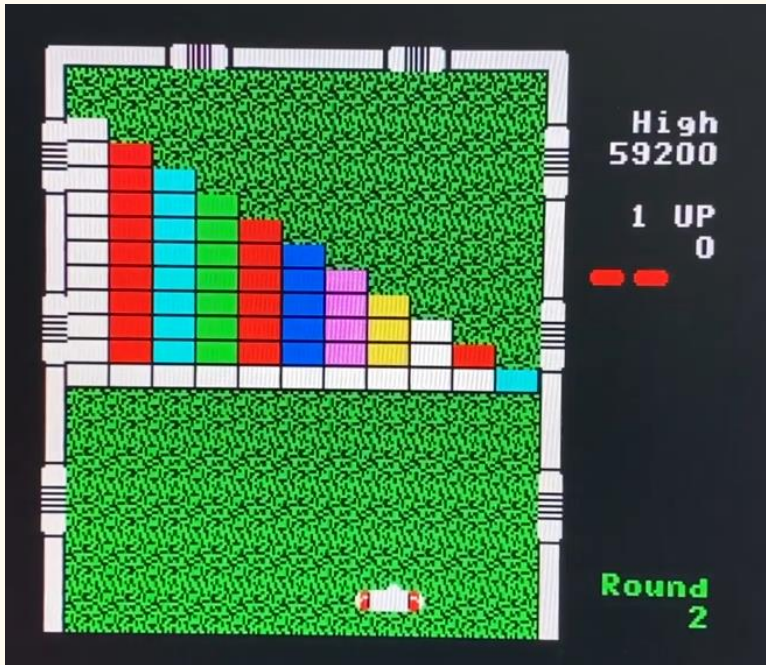

### WATERCOOLER POLTERGEIST

Watercooler Films (a rather large YouTube channel with over 18,000 subscribers), put up some raw footage of Poltergeist gameplay, which was recorded for "the review series Take Me To Your Leaderboard", which is a podcast about B movies. I think this is a branch show about playing video games based on movies (their main podcast is Bad Movie Fiends): [YouTube link](#), their [podcast](#) page, their [Patreon](#) page.

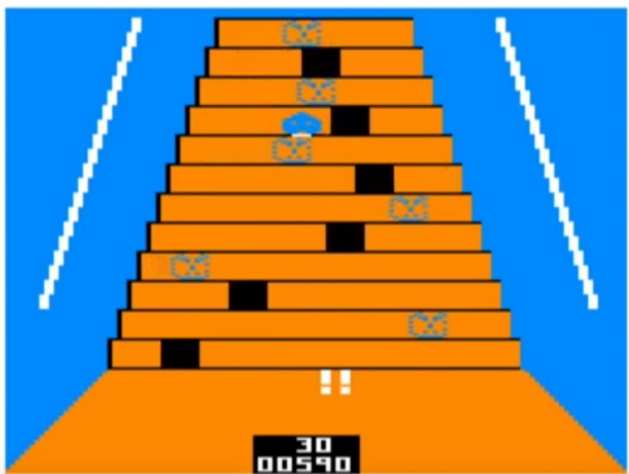

### COCO2 MOTHERBOARD CLONE REV B

Rocky Hill has released a video showing his new Rev B main board CoCo 2 main motherboard. [YouTube link](#) And he has completed it and installed it in the case (and replaced an incorrect capacitor so that color artifacting now works, and fixed the E and Q clocks): [YouTube link](#) And a, as he describes it, "weird RF thing I made" to clean up some of the RF interference he was getting. [YouTube link](#)

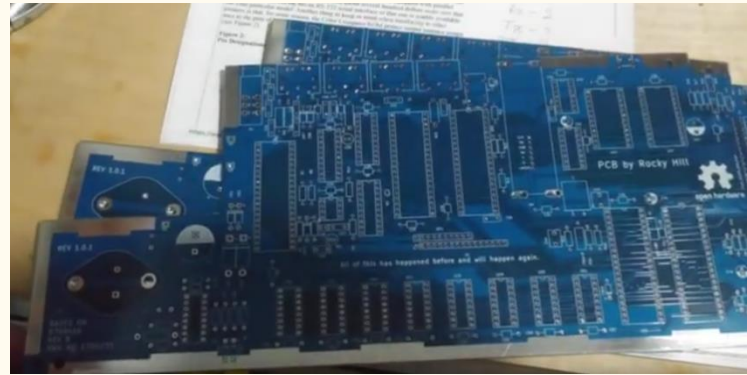

### SMOOTHER SCROLLING AND DAC TRICKS

Simon Jonassen has an updated video showing the smooth scrolling VDG text screen hardware trick. [Facebook link](#) He also put up a video showing a demo sound program that uses both the 6 bit DAC and 1 bit sound output's simultaneously for two voice music in hardware. [Facebook link](#)

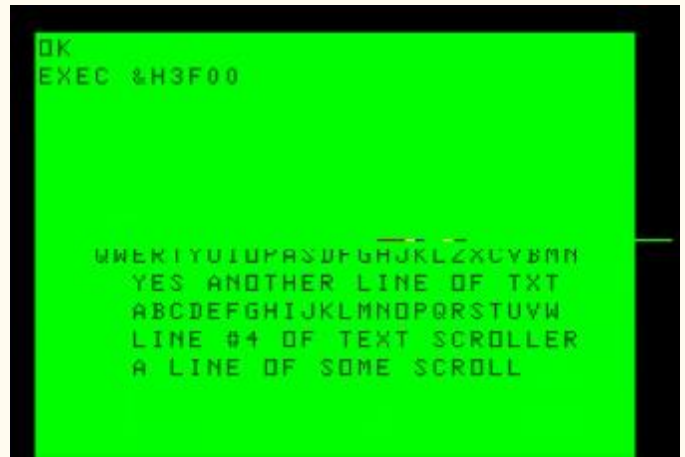

### HEADLESS NITROS-9

Barry Nelson has uploaded some "headless" NitrOS-9 Level 1 disk images to the Facebook CoCo group. These are set up to boot with a shell onto the serial bit banger port (so that you can use a terminal, or another computer with a terminal program), and he has versions available for 300,600,1200 and 2400 baud. This was requested by some people who want to run 80 column (or higher) terminal programs to use their CoCo 1's. [Facebook link](#) He also put up a ROM image for ADOS 3 Extended, with will automatically execute the DOS command when the CoCo 3 is turned on, unless you hold down the spacebar. You can either burn it into a 16K ROM, or

install it in one of the extra ROM "slots" on the CoCoSDC.

[Facebook link](#)

### NEWTECH MODEL 68 CLONE

Paul Fiscarelli put up a video showing his newly acquired SWTPC 6809 system, and how he got a 6 bit DAC Newtech Model 68 Music Card cloned for it (the original board was from 1977). [YouTube link](#)



### COCOCREW APRIL 2021

April's CoCo Crew episode has dropped, and includes a tech discussion on the TIMER function in Extended BASIC, and a discussion about the CoCo hobby getting more expensive, and thus not as much fun, for some. [Podcast link](#)



### COCO 2 WITH DELUXE KEYBOARD

Tom Best put up a video on YouTube with his original CoCo 2 (with Extended BASIC) - his first computer (he even upgraded the keyboard to the 57 key that was originally for the unreleased Deluxe, added a composite video out with inverse video, and mentions that he did dabble with ML enough to write his own ML subroutines). [YouTube link](#)



### 8-BIT COINS

An interesting discussion on the CoCo Facebook group - a program has been written for the Commodore 64 to mine bitcoins. PCGAMER had an article that it would take at least 50 trillion years to mine a single bitcoin... and the speculation is if the CoCo could cut that in half, and **only** take 25 trillion years. [Facebook link](#)

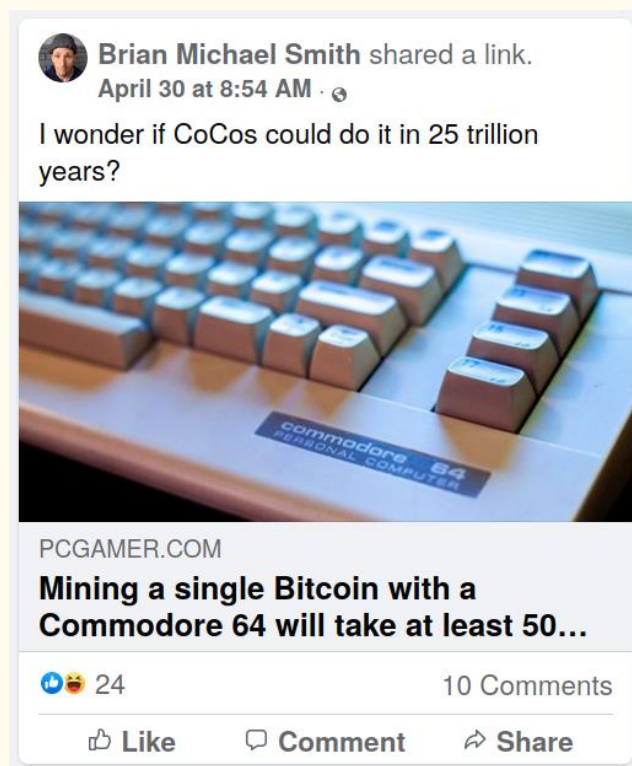

### SCREEN CHARACTER FADING

John Laury did a quick little ML demo of a way to "fade" characters out (or in, if you wanted) on a screen, by bumping the ASCII values up by 1. [Facebook link](#)

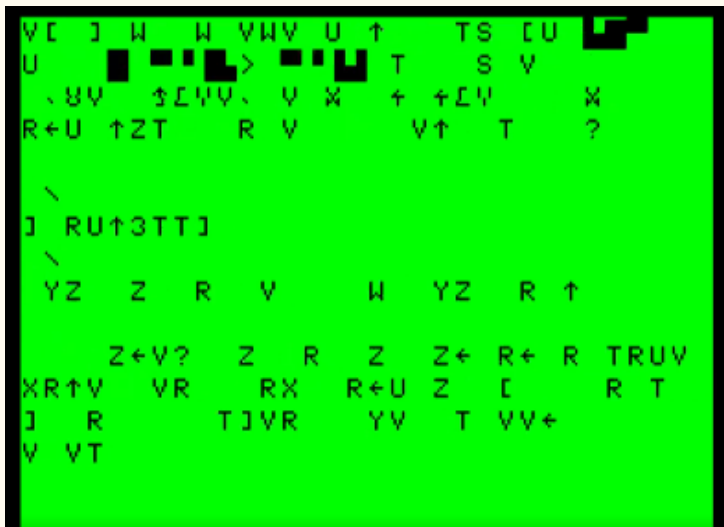

### RS SWAG

Radio Shack seems to have the CoCo badge shirts up for sale again (they disappeared for a while). [Facebook link](#)



### TP-10 GRAPHICS?!?

Robert Sieg posted a picture of a "graphics" dump he did with his MC-10 and TP-10 printer - which isn't supposed to be capable of graphics. [Facebook link](#)

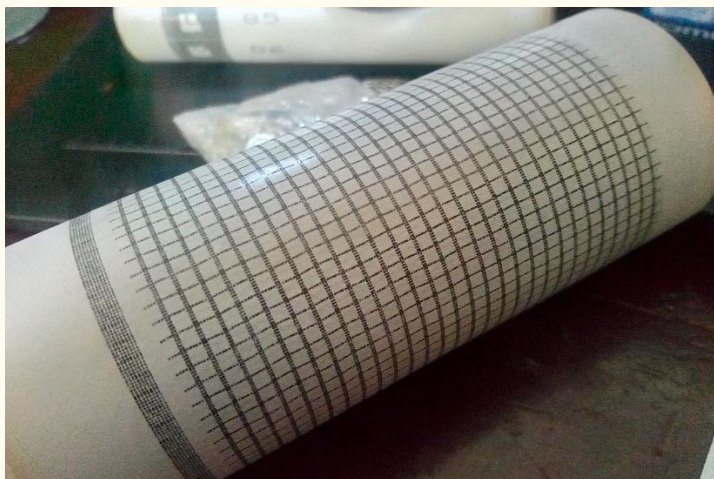

### COMPUSENSE FIX

John Whitworth (who has been making the DragonPlus boards that we have talked about in recent months - the +64K, 80 column screen upgrades based on the original Compusense designs from the 1980's) discovered a "tiny error" in the Compusense boards, which can cause some video problems on some of the original boards. He has a simple fix for it, involving adding just one wire to ground. [Facebook link](#)

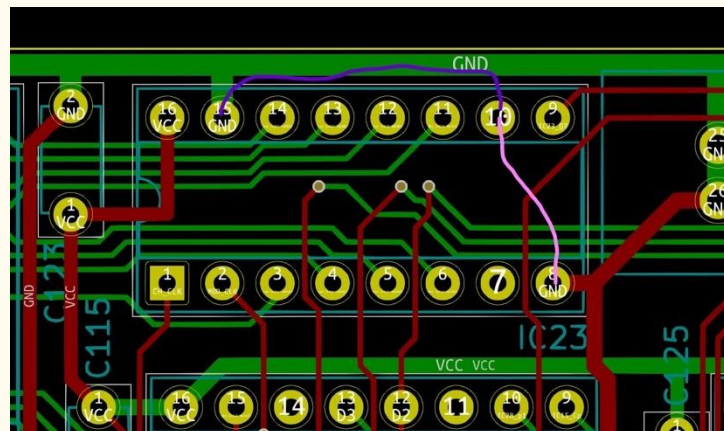

### MISBEHAVING DRAGONPLUS

John also posted a video explaining an issue he was having with his new DragonPlus boards, and how he fixed it (he thought it was the brand of PROM chips, but it turns out to be a bad 78HC04 chip, with a gate not behaving at high speed). [YouTube link](#)



### DRAGON 32 REPAIR VIDEOS

The Digital Orphanage put up their final Dragon 32 repair/test/play videos (which we have covered before), where he finishes fixing up the last Dragons for the museum (and, as it happens, to sell some extra ones off). He goes into tracking RAM chip problems, and fixing some keyboard issues, as well as testing some Dragon games. Also, a rather interesting 64K RAM upgrade on the Dragon 32. [YouTube link](#)

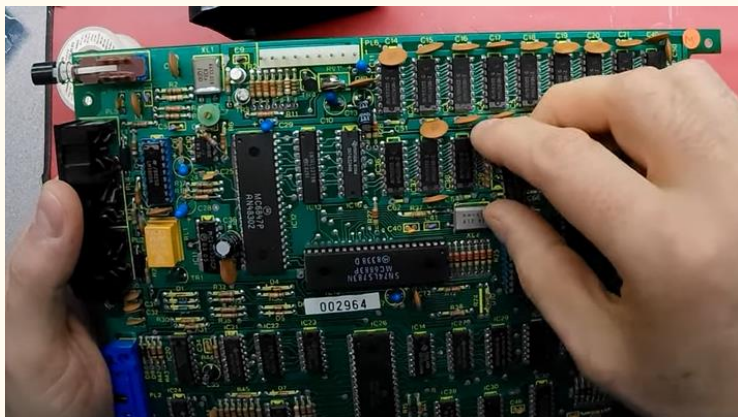

### MC-10 BERZERK COMPILED

Jim Gerrie has released a compiled version of his MC-10 Berzerk game, with a newer method for handling diagonal movement from the arrow keys on the MC-10 (the latter suggested by the author of the MC-10 BASIC compiler, Greg Dionne). Normally, an INKEY\$ will only read 1 key at a time; this has to read two. [YouTube link](#)

He also released a new version of his Micro Checkers for the MC-10, that fixes a couple of bugs: the AI wouldn't always do double jumps against you, and you could jump in the wrong direction with un-kinged pieces after your first jump. He also added a cursor key select: [YouTube link](#)



### MORE COCOVGA POKER SQUARES

Paul Shoemaker posted some more updated screenshots for his special CoCoVGA edition of his Poker Squares game, which uses the 128x96x16 color VG6 mode that the CoCoVGA supports. It's coming along nicely! [Facebook link](#)... and then he finished the game this week, and has released it (should be on the archive soon). He also has a video showing it off. Remember, this is a CoCo 1 or 2 playing it, with the CoCoVGA upgrade. [Facebook link](#) And if you want to get the game right away from Face book, he has it in the CoCo group in the files section. [Facebook link](#) Or from Brendan's CoCoVGA page. [Website link](#)



### FRANKEN JOYSTICK

Mike O'Hearn Sr. on Facebook showed his "Franken Joystick" - a homemade hack that is almost 2 small paddle controllers to control each axis... as he says, until he can get a real one. This might actually make some games easier to play, like Popcorn, Catch 'Em, Warlords, Space Assault, etc. [Facebook link](#)



### DONKEY KONG REMIX HDD LOADING

Henry Reitveld uploaded a video showing him loading/playing Donkey Kong Remix the old-fashioned way - from a precariously balanced real hard drive. [YouTube link](#)



## ROBOS DRAGON VIDEOS

A YouTube channel I have not seen before (called ROBOS) released a video of playing some Dragon games (those starting with the letter C). I believe that he is Polish and does various retro game videos)... and he plays some games not often seen (or I have never seen in action before). He is playing on an emulator, as evidenced by some NTSC CoCo ports that are showing artifact colors. [YouTube link](#)



## COCO3 HARDWARE TEXT MODE STUDY

Tim Lindner has put up a blog post studying CoCo 3 hardware text modes, including "unsupported" modes. [Website link](#)

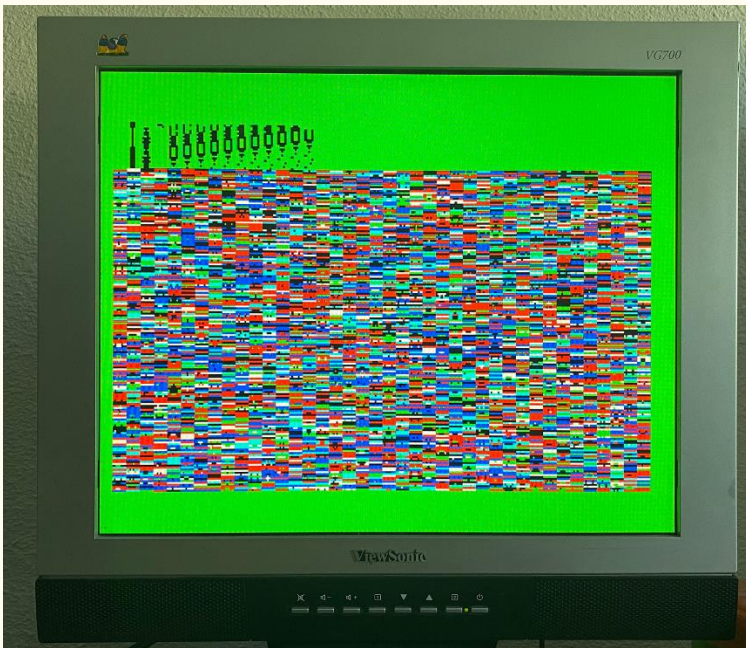

## MRDAVE6309 JOYSTICK PROTOTYPE TESTING

MrDave6309 put up a quick video showing him testing a joystick prototype he is working on. [Youtube Link](#)

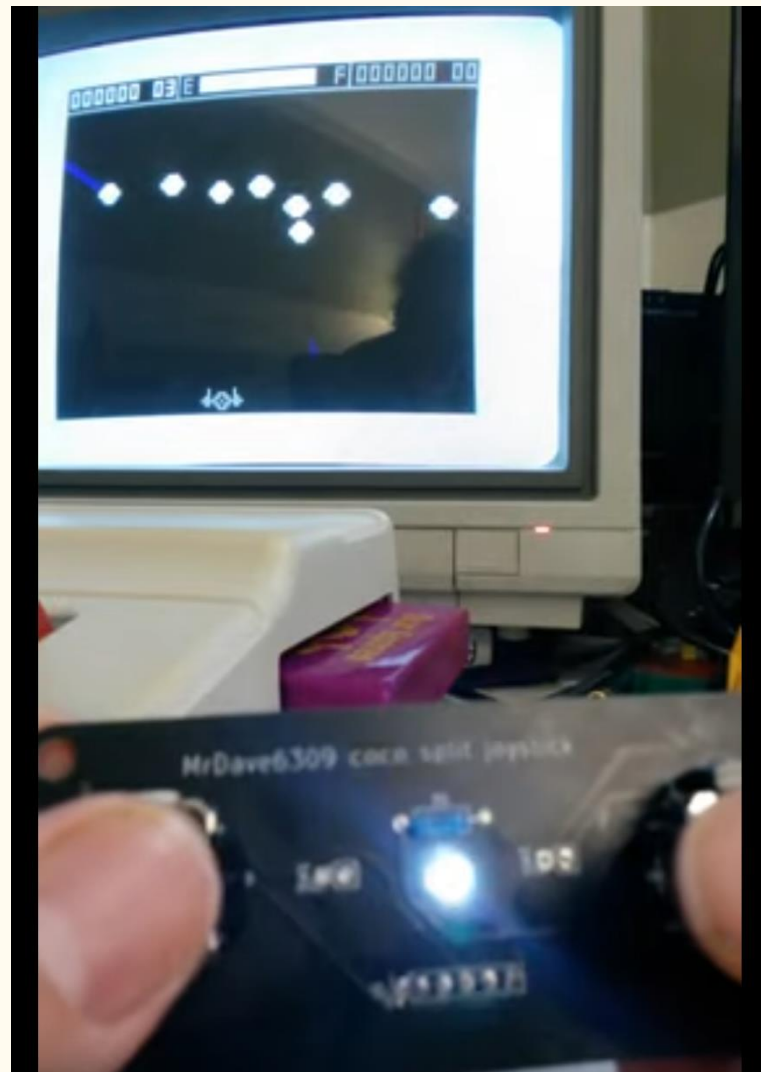

## RAINBOW POSTER

Brian Wiesler found one of the posters that Rainbow did (and was partially used for both the covers of Rainbow January 1983, and the first Rainbow book of Adventures) with a D&D theme, and framed it. I did have a friend here who had a similar poster, but I can't remember if that was separately ordered or came with either the magazine or the Adventure book. [Facebook link](#)





## TANDY ASSEMBLY GUEST SPEAKER POLL

A quick mention - John Linville has set up a poll on Facebook of what guest speaker(s?) people would like to see at Tandy Assembly this year. If you are planning on attending, please add your vote. [Facebook link](#)

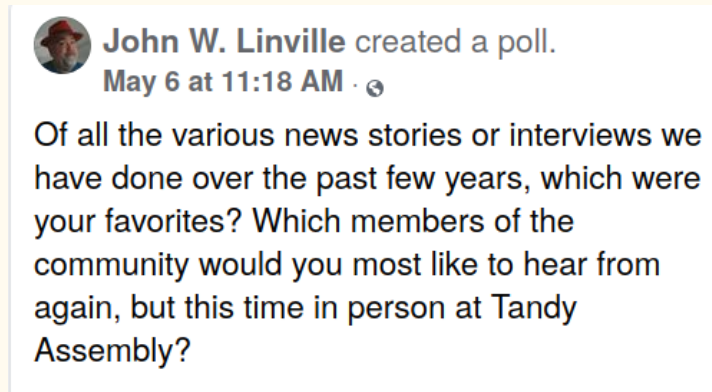

## REAL TALKER

Mike Gideon on the CoCo Facebook group posted photos of a rare speech cartridge for the CoCo that he required - Real Talker by Colorware. I remember this one featured a "talking head" program, and I believe had a more advanced speech chip than the Tandy Speech/Sound pack. [Facebook link](#)  
Ad from October 1984 Rainbow for Real Talker. [Website link](#)



## GIME VIDEO TEST

John Laury has been learning how the GIME video modes work in assembly language, and has made his first ML program that puts the CoCo into 80 column mode, clears the screen (including attribute bytes, new to the CoCo 3) and writes some text. [Facebook link](#)

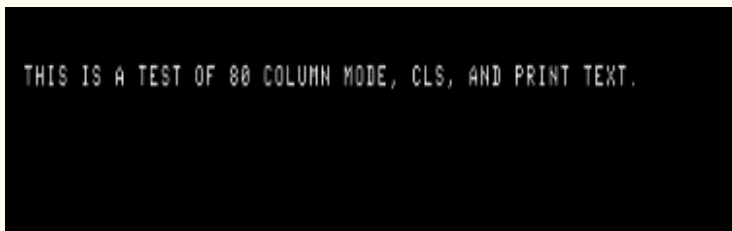

## CUSTOM FD502 CONTROLLERS

Steve Adolph made a custom FD502 controller clone (much smaller than the original) for himself, but has a couple of spare ones available (well, hopefully still by the time we air this). If interested, you can contact him via his Facebook post. [Facebook link](#)

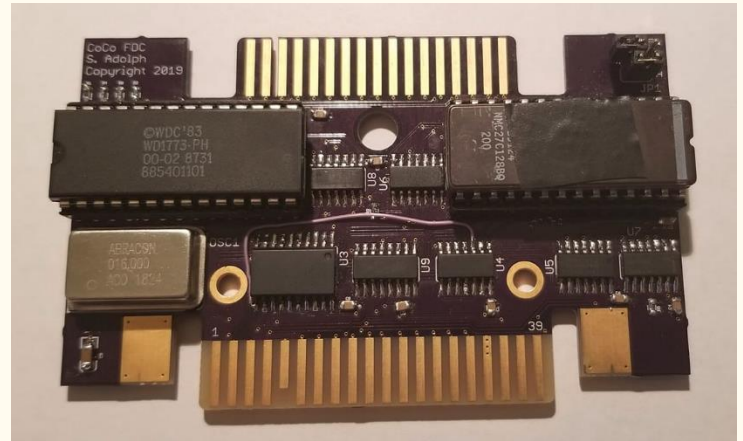

## PSG FLASHING

Sheldon MacDonald, fresh of his release of Treasure Island Defense, is working on flashing the PSG board (which is a sound/joystick/flash ROM card that he has made the game available on). So he is taking suggestions on making a boot menu for the Flash ROM part, and having some other pre-flashed software on it as well as his game (things like Drivewire access, etc. could easily be done). Please comment if you have some ideas to fill the 512K Flash ROM (see comments for a screenshot example of his animated menu prototype). [Facebook link](#)



## COCO3 DIAGNOSTICS SOFTWARE SOUGHT

Don Barber posted a message on Facebook about a manual (from Tandy) for the CoCo 3 Diagnostic disk, but has been unable to find a copy of the disk itself. I have never found it either - if anybody has, please let us know where to find it - I would love to see it myself. [Facebook link](#), [The manual](#).

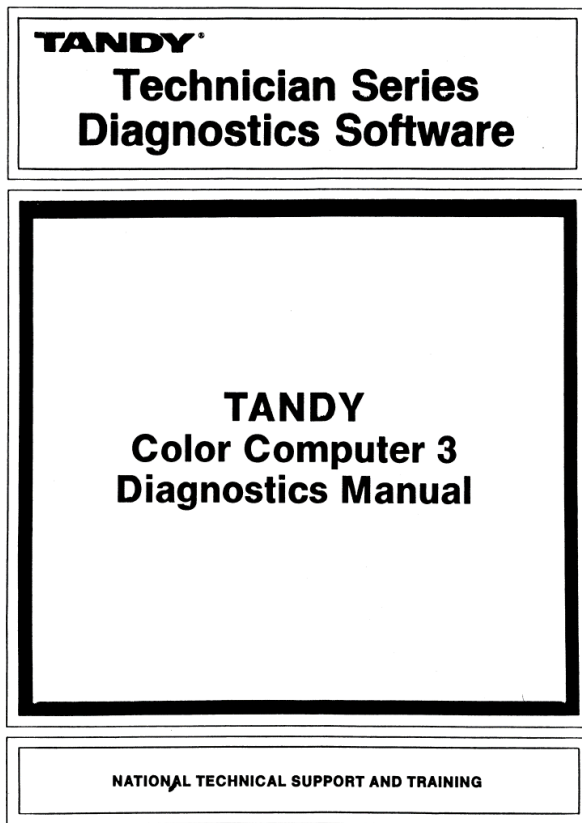

## MULTI-COLOR MC-10

Robert Sieg posted some screenshots of all of the colors available on the MC-10 - including the extra (beyond 9 basic ones) for inverse text (which has a dark green), and the alternate colorset (which features a dark red, and a different orange than the normal orange). Included is some SG6 screenshots, which allow 4 colors at 64x48 resolution. [Facebook link](#)

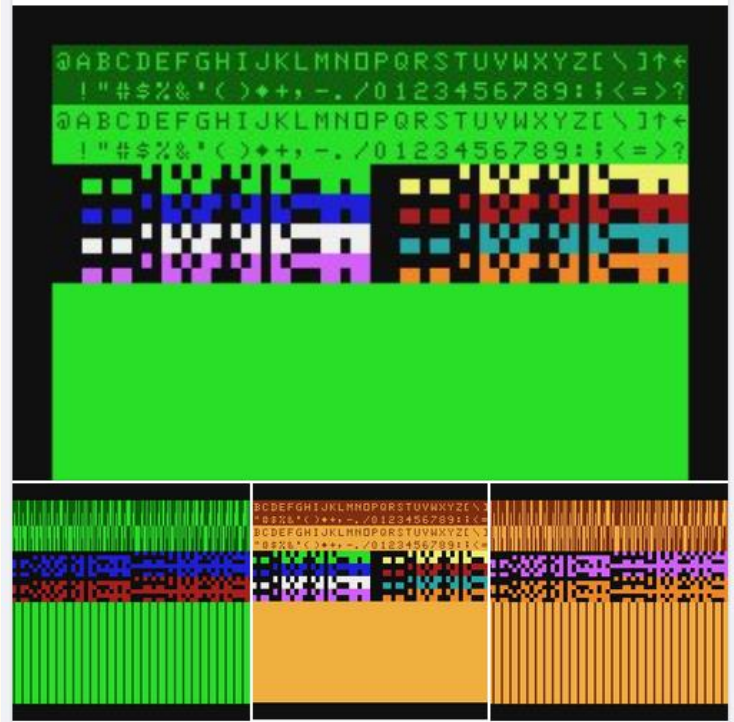

## MORE TP-10 GRAPHICS

Robert Sieg has also continued his experiments in producing a graphic screen dump type program for the MC-10 / TP-10 combo - the latter of which does not have a graphics mode. [Facebook link](#)

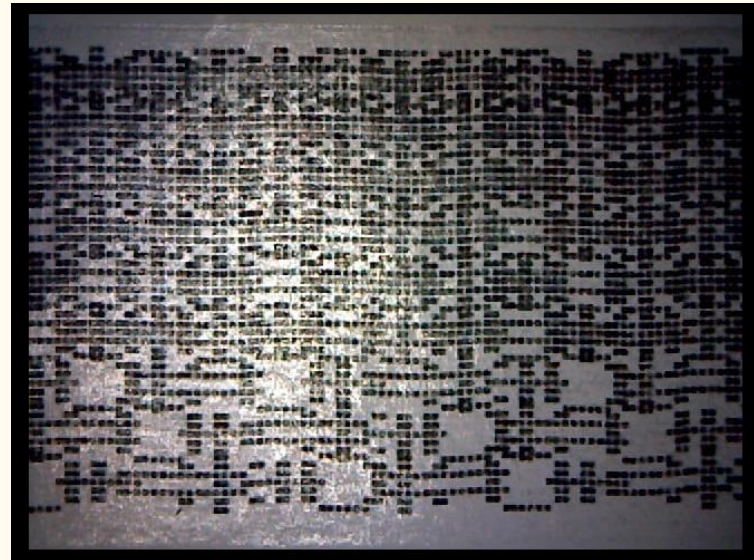

## DRAGONPLUS MODE SWITCHING

John Whitworth of DragonPlus Electronics has put up a video updating the work on the MSX2+ board. Programmatic switching between the 6847 / RGB board on the MSX2" V9958 RGB is now working properly. [YouTube link](#) And using a game conversion that Pere Serrat has been working on. [YouTube link](#)



## A DRAGON HOARD

Mark Elliot posted 7 cartridges for the Dragon, still in their original boxes, which includes some 3rd party games that were only available on tape or disk in North America. [Facebook link](#)



## DARTH DRAGON

Similar to some people in the CoCo community who have made "Darth Vader" versions (making the case black), Tom Alexander did the same for his Dragon 64. [Facebook link](#)



## NEOTECK UPSCALER REVIEW

Atari User on YouTube reviewed the Neoteck NTK022 SCART to HDMI convert/upscaler, using Atari 800XL, Atari 130XE and Dragon 32's for testing. [YouTube link](#)

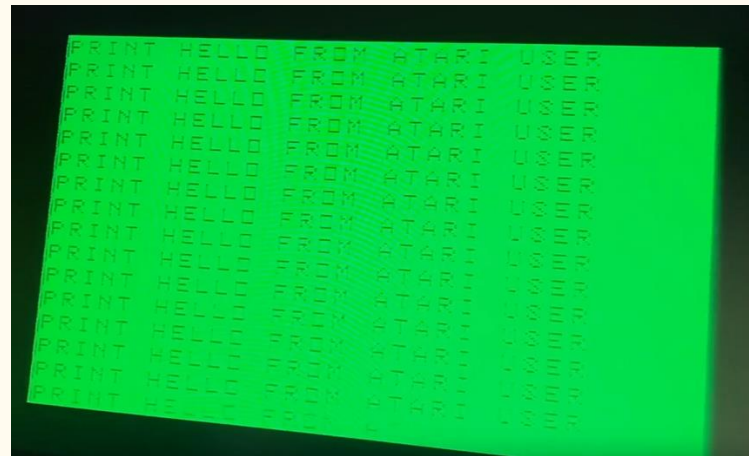

## 8-COLOR PMODE 3



Carlos Camacho put up a screenshot from an old NEC PC6001 (this computer used the same VDG as the CoCo/Dragon/MC-10), which allowed mixing color sets more easily than the CoCo can. It has an interesting design with the score/radar

area in one color set, and the main gameplay area in the other. This is possible on the CoCo (see DragonFire as an example) and might open up some ideas to make a PMODE 3 style game with all 8 colors. [Facebook link](#)

### ZERO HOUR #5

Nick Marentes posted up his 5th blog for his upcoming game Zero Hour, this time showing the title, top 10 score and bomb countdown screens. [Website link](#)



Level 0 + Title Page

### CROSS HORDE

Fabrizio Caruso, who works on "universal" cross-platform games for 8 bit machines (roughly about 200 systems!) has released his 5th such game, including for the CoCo/Dragon. This one is called Cross Horde. [Facebook link](#) Download links for all 5 of his universal games, and the Cross Lib hardware abstraction layer library. [Website link](#)



### MC-10 COMPUTING NOW! POKER IMPROVEMENTS

Jim Gerrie has made some aesthetic changes to his MC-10 port of the Computing Now! Poker game. [Facebook link](#) In the comments, he also shows an update to his checkers game, changing the colors of the pieces a little, and improving the AI. He also has some alternative color sets for the Poker game.

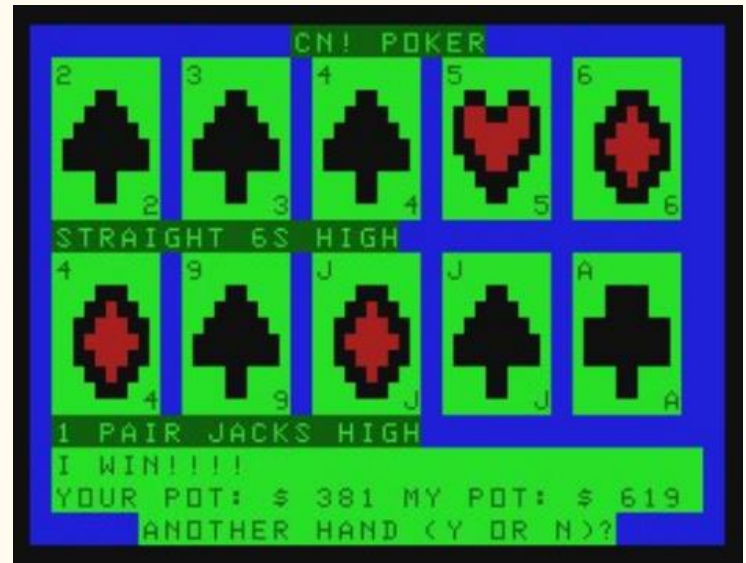

### MC-10 VINYL

Robert Sieg posted a poll in the MC-10 Facebook group for what games that Jim Gerrie has made or ported should be on a proposed "Jim's Gone Gold" LP (a real 12" LP similar in concept to the flexi-disc that Rainbow did back in their July 1983 issue). [Facebook link](#), Custom LP details. [Website link](#)

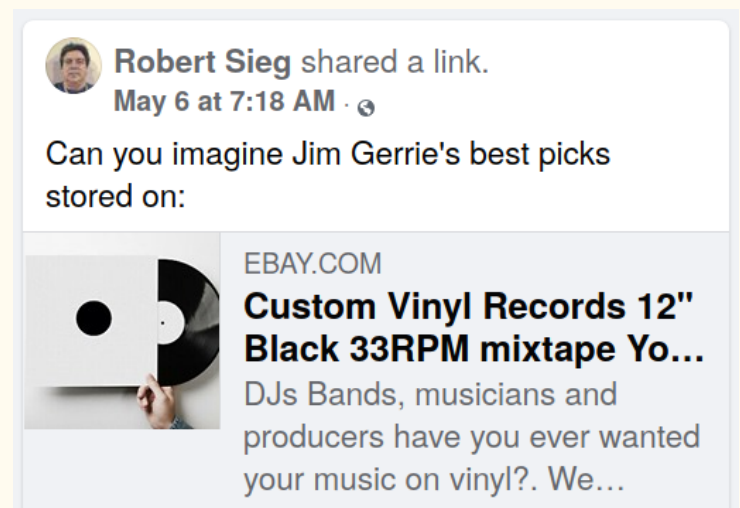

## OLD SCHOOL GAMES & STORIES

A new (to me, anyways) YouTube channel, "Old School Games & Stories", where he talks about his first ever video game system - The CoCo 2. [YouTube link](#)

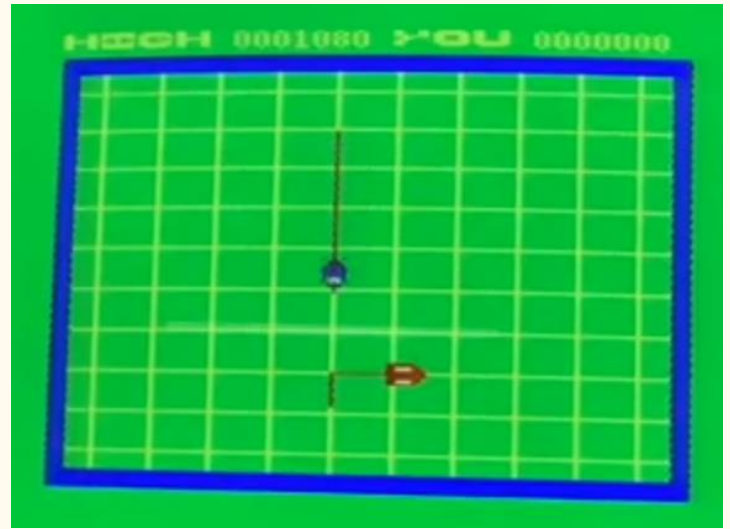

## DONKEY KONG CLONE COMPARISON

Retromantra has done a video comparing some clones (or derivatives) of Donkey Kong from various systems, including Donkey King on the CoCo. [YouTube link](#)

## TRS-80 PICKUPS

Jason Vectrex on YouTube posted a video of TRS-80 pickups he just got, including an assortment of CoCo game cartridges. [YouTube link](#)



## ROBOS CARRERA

ROBOS on YouTube did another "Dragon games that start with " video, this time starting with "D" (Decathlon is not Olympic Decathlon, but a collection of 10 mini games). Carrera is another new one to me (near the end). [YouTube link](#)

## CUTHBERT DRAGON TUBE WAY ARMY AND TRUN

Cuthbert Dragon has continued to be active with his Dragon gameplay videos on real hardware, including some we may not have seen before, including Tube Way Army (A Scramble clone), and Trun (a Tron clone I have definitely not seen before). [YouTube link](#)

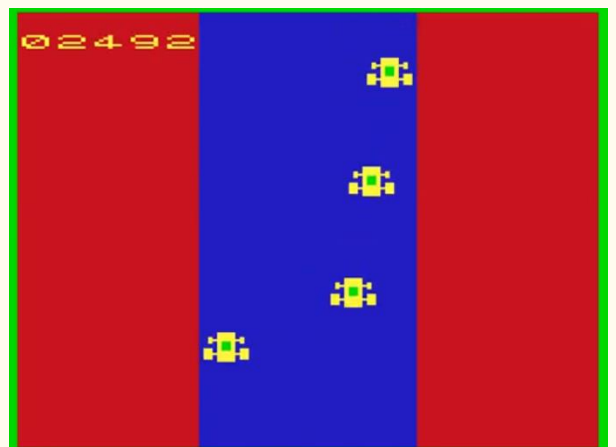

## AMIGOS 300TH

First up, a big congratulations to "Amigo" Aaron, John "BoatofCar" Shawler and "The" Brent on the 300th episode of their Amigos podcast that they just recorded last night. They mention the other shows (including the CoCo Show) that are now part of their vast podcast empire as well. The episode does a humorous look back from the beginning until now. [Twitch link](#)



## 80 COLUMN COCO3 CODE STARTER

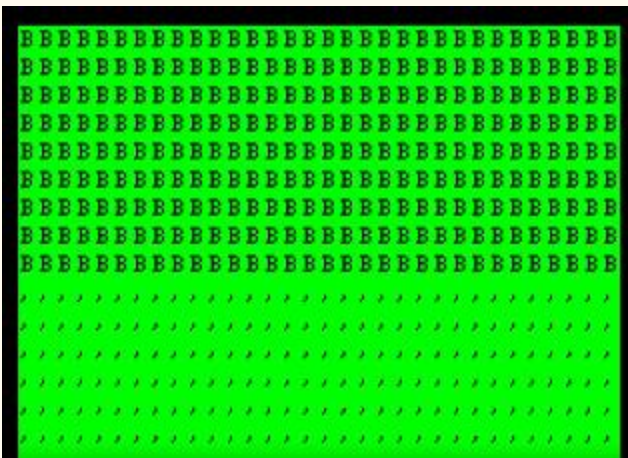

John Laury put up a 20 minute tutorial video on programming a CoCo 3 to go into the 80 column mode (including setting palettes, the MMU, and GIME), as we discussed on the last show. It's a good "starter" program for people to use to learn how the CoCo 3 works, and how it is different to program compared to the CoCo 1/2 using the VDG / SAM combination. [YouTube link](#) He also revisited his screen clearing routine (that shifted characters), and now makes it a kind of cross-dissolve. [YouTube link](#) John also put up a video demo (done in pure BASIC), with a challenge for people to figure out what he did. Cathe Cite figured it out (changing the BASIC character to CLS a screen with), and in the comments Cathe explained how the CLS hook was also used to crack the autostart protection used by Tandy Germany Microdeal tapes. [Facebook link](#)

## PSG FLASH LOADER

Sheldon MacDonald has a video showing his progress on his Flash ROM boot loader for the PSG cartridge from Ed Snider

over at zipsterzone.com. It will eventually support icon data, long filenames, and booting types of programs other than just ROM images. [Facebook link](#)



## COCOMAX ROUNDTABLE

Retro Computing Roundtable episode 234 talked about the CoCoMax hardware interface and the two versions of the Color Mice, based on an eBay listing. [YouTube link](#)

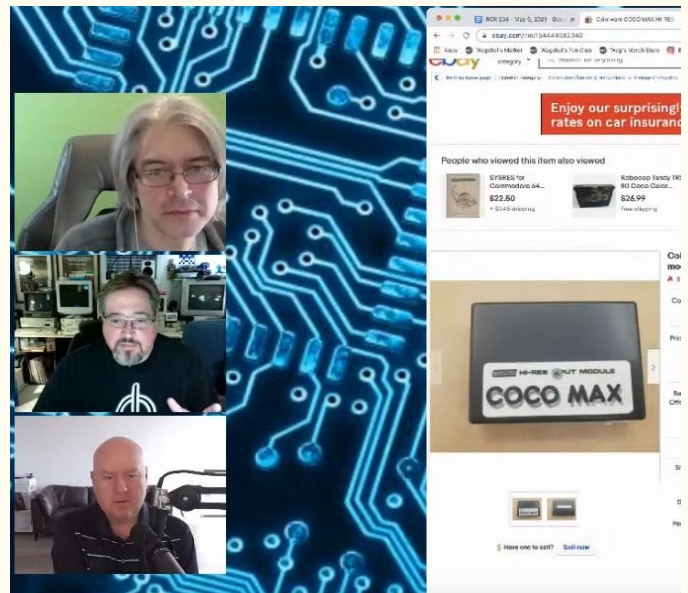

## GIME IRQ TIMING

Tim Lindner has another blog post up that happened because of fixing an issue in MAME; this time with specific settings on the CoCo 3's GIME IRQ timer. [Website link](#)

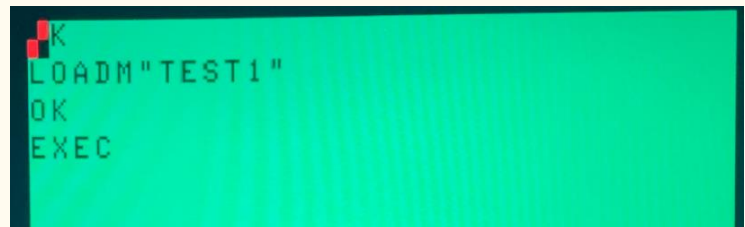

## DRAGON32 SOFTWARE SPRITES

chibiakumas (Keith) on YouTube has released his next Dragon 32 assembly language episode (applicable to the CoCo 1/2 as well), now working on software sprites (using the XOR technique in this case). [YouTube link](#)

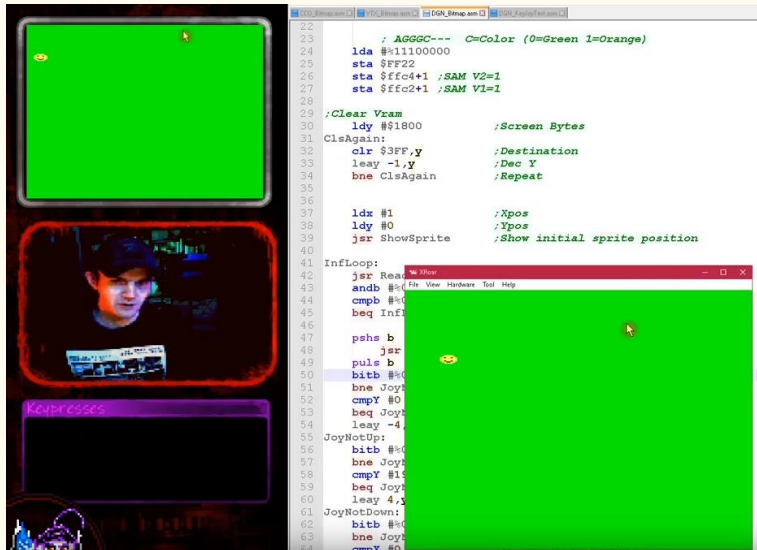

## CRT KEN NEXT PROJECTS TEASER

Ken at Canadian Retro Things shows some of Mr Dave 6309's prototype cartridge boards (it also includes some Atari prototype boards, a 3D printed battery cover for an old electronic games Ken has). [YouTube link](#)

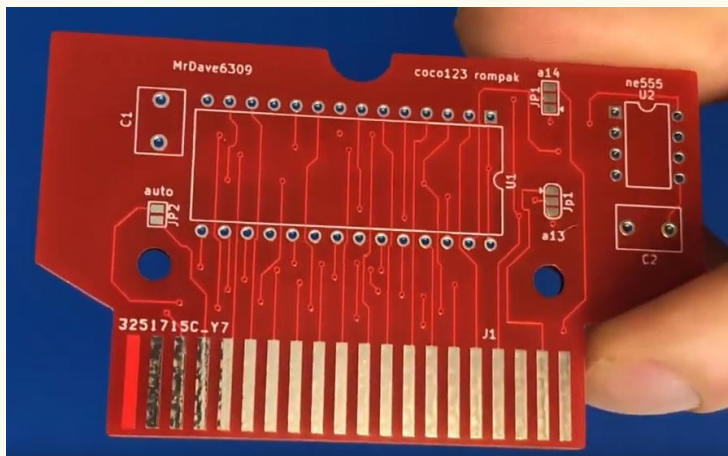

## HOW BASIC TOKENIZATION WORKS

Jerry Stratton has posted a blog (and code) for a BASIC program to explore through the BASIC ROM's, and how tokenization works. [Website link](#)

5	0000	26	18	00	05	3a	83	43	48	52	49	53	54	4d	41	53	20	&...:CHRISTMAS
	0010	53	48	4f	57	20	31	39	38	35	00							SHOW 1985.
6	001A	26	2b	00	06	3a	83	42	59	20	4d	49	4b	45	20	48	41	&+...:BY MIKE HA
	002A	4c	4c	00														LL.
10	0068	26	90	00	0a	95	32	30	30	2c	26	48	33	44	30	30	3a	&...:200,&H3D00:
	0078	8c	20	53	41	4e	54	41	28	34	30	29	2c	4e	24	28	36	. SANTA(40),N\$(6
	0088	30	29	3a	c9	22	56	33	30	22	00							0):"V30".
19	0092	26	ab	00	13	3a	83	6d	65	72	72	79	20	63	68	72	69	&...:merry chri
	00A2	73	74	6d	61	73	20	6c	6f	67	6f	00						stmas logo.
20	00AD	27	20	00	14	9e	30	3a	80	58	b3	31	30	32	34	ab	36	'...0:.X.1024.6
	00BD	39	a5	31	30	32	34	ab	39	30	3a	81	a6	35	30	3a	8b	9.1024.90:...50:.
	00CD	3a	80	58	b3	31	30	32	34	ab	31	30	31	a5	31	30	32	:.X.1024.101.102
	00DD	34	ab	31	32	32	3a	81	a6	35	30	3a	8b	3a	80	58	b3	4.122:...50:..X.
	00ED	31	30	32	34	ab	31	33	33	a5	31	30	32	34	ab	31	35	1024.133.1024.15
	00FD	34	3a	81	a6	35	30	3a	8b	3a	80	58	b3	31	30	32	34	4:...50:..X.1024
	010D	ab	31	36	35	a5	31	30	32	34	ab	31	38	36	3a	81	a6	.165.1024.186:..
	011D	35	30	3a	8b	00												50:..

## ARTIFACT CONTROL UTILITY

Barry Nelson uploaded a utility to Facebook that can reverse the red/blue artifact colors on a CoCo 3, without affecting any other default colors in the system (the F1/RESET trick resets ALL colors, including semigraphics, and PMODE 3 colors). If you have a program that uses multiple graphics or text modes, plus an artifacting color mode, this should be much closer to what you would expect for colors, like a CoCo 1/2 (he includes ASM sourcecode as well). [Facebook link](#)

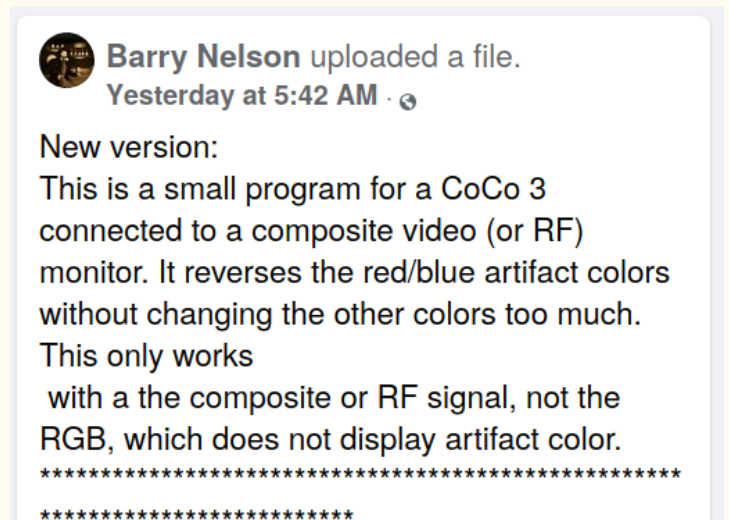

## COCO1/2 RAM/ROM MODE TEST

Richard Kelly also uploaded a utility to Facebook for CoCo 1/2's with 64K. It tests to see if the CoCo is already in 64K RAM mode (ie the BASIC ROM's are copied to RAM, and thus you can modify BASIC), and if not, does it for you. [Facebook link](#)



**Richard Kelly**

May 13 at 5:40 PM · 🌐

Got a CoCo 1 or 2? You'll probably want this program. It tests to see if the CoCo is in All-RAM Mode, and if isn't, it enables it. BTW, that "55520" memory location is reportedly an unused area of the Disk ROM, and its size is roughly 1.5K from beginning to end. I chose the location I did because it's ideal for storing graphics from the leftmost pixel of the graphics page.

```
A=PEEK(55520):B=255-
A:POKE55520,B:IFA=PEEK(55520)THENC=1:
FORA=480TO506:B=VAL("&
H"+MID$("1A508E8000A684B7FFDFA7808C
E0002705B7FFDE20EF1CAF390000",C,2)):P
OKEA,B:C=C+2:NEXT:EXEC480
```

👍❤️ 9

1 Comment

👍 Like    💬 Comment    ➦ Share

### 12V FLOPPY CONTROLLER HAUL

Raymond Jett picked up around 60 of the old 12 volt floppy controllers (designed for the CoCo 1) that are 1) untested), and 2) only have the bottom half of the cartridge shell. Good for parts if you have one of these controllers, and this is one of the controllers that can be modded to handle high density (1.2 / 1.44 MB floppies). Since they are untested, they are going for only \$8.00 USD, and he has sold a little over half of them by yesterday (I don't normally mention for sale items (except lately, apparently), but since this is a limited quantity, am mentioning it today). [Facebook link](#)

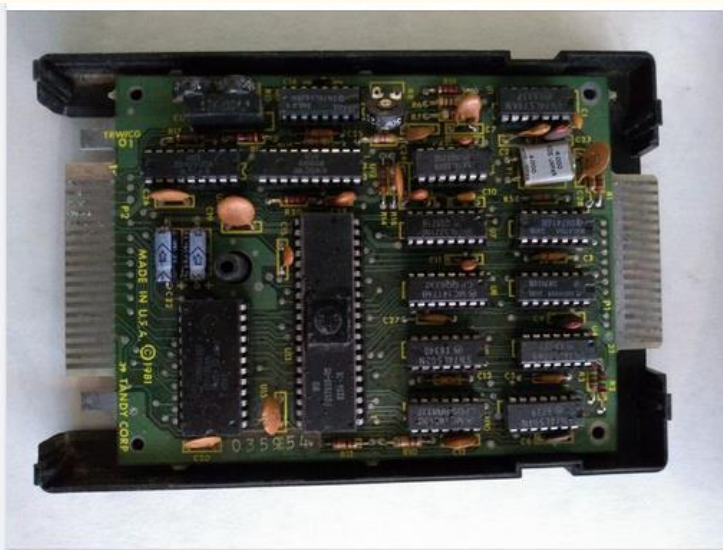

### COCO DIGITAL SOUP

The Digital Soup Podcast (kind of a tech related variety/comedy show, covering computers, music, cameras, gadgets, etc.) leads in episode 208 talking about Jason (one of the 3 hosts) digging his old CoCo 3 out, and getting it working with some modern equipment from the current community.

[Website link](#)

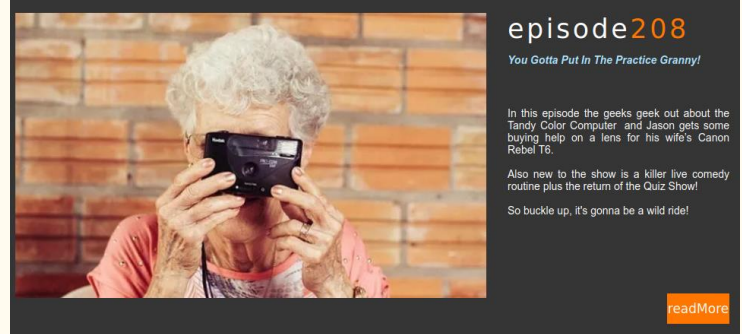

### RETRO REWIND ASKS

A question from Frank of Retro Rewind: They are thinking of getting into the CoCo market, possibly with a very fast 6809 replacement as one of the projects. What is the interest in the community, and on the panel, for something like this? If there is interest, we would like to invite Frank onto the show, and he should be in chat today for any questions. [Website link](#)

### NITROS9 / EOU BETA 6.1

Bill Nobel and I (along with contributors like Frank Provenchko, Todd Wallace, Jeff Teunissen, Walter Zambotti, etc.) are proud to release NitROS-9/EOU Beta 6.1. This includes an updated Control Panel, updated Calendar app, a new Sierra game demo, a text adventure game done with graphic window panes (I will speed this up sometime in the future; Shawn Driscoll, the author, was just learning when he wrote it), a new version of the DCC C compiler with better optimization and unsigned long support, Musica song play support from GShell, and ports of various Unix power utilities, plus more. I worked on it until 5 AM Monday morning, so I screwed up the initial upload. If you grabbed in the first day or two, please re-download it to make sure that you have the current one. The 6809/6309, and GIME-X 6809/6309 versions are up now; Bill is working on the Matchbox/MiSTer versions which should be done soon. [Facebook link](#)

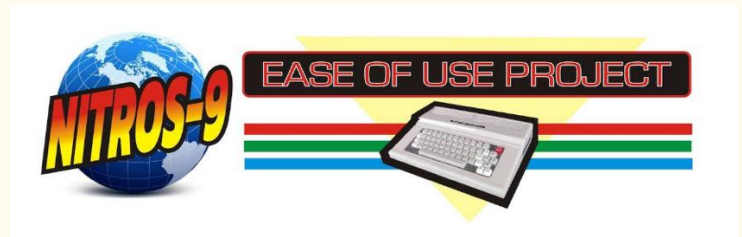



## MC-10 32 X 32 X 9

Robert Sieg put up a photo and video to show a 32x32x9 color screen. Not sure what exactly he is doing - colorset switching, maybe? Done on real hardware. [Facebook link](#)



## DRAGON DRAM REFRESH TIME TESTER

Stewart Orchard put up a cool memory testing utility for the Dragon a few weeks ago; rather than "just" testing the memory contents, it actually figures out how long the DRAM can retain the test data before a RAM refresh is needed. [Website link](#)

A screenshot of a GitHub repository for 'Dragon Refresh Test'. The repository is owned by 'D' and has 0 stars. It contains 2 commits, 1 branch, 0 tags, 276 KB of files, and 276 KB of storage. The description states: 'A program to help determine how long a Dragon 32 or 64 can retain its memory contents while DRAM refresh is disabled'. The repository is named 'dragon-refresh-test' and has a 'Clone' button. A recent commit is shown: 'Added cartridge rom version. Fixes to README.md' by Stewart Orchard, authored 3 weeks ago.

## FRANCHISE! ON AMIGOS



Amigos Retro Gaming presents had the subject of "Manager games - Non Sports". One of the two games they reviewed is the CoCo 1/2 game Franchise! by Computerware. [YouTube link](#)

## SPACE BANDITS UPDATE

Jamie Cho has released an updated version of his CoCo 3 (or Mac) space shooter game, Space Bandits. The Facebook post has links for the 6809 CoCo 3 and Mac versions in the main message, and the comments section has a link to the 6309 optimized version as well. The game is now labelled "Level 1", with a Level 2 sequel planned, and while first wave is basically the same as the previous release, waves 2 to 5 are quite different. [Facebook link](#)



## MC-10 MAXIT AND POKER UPDATES

Jim Gerrie has ported a game originally from the Commodore PET called Maxit (that was published in Cursor magazine in 1981). He based his version on an IBM PC port of the game. [YouTube link](#) He also did some further updates to the Poker game he showed last week, and was taking color suggestions on. [YouTube link](#)



**CUTHBERT DRAGON RIVER OF FIRE AND DUNGEON DESTINY**  
 Cuthbert Dragon has been busy again this week. New games to me are Home Base [YouTube link](#), River of Fire [YouTube link](#), Dungeon Destiny. [YouTube link](#)

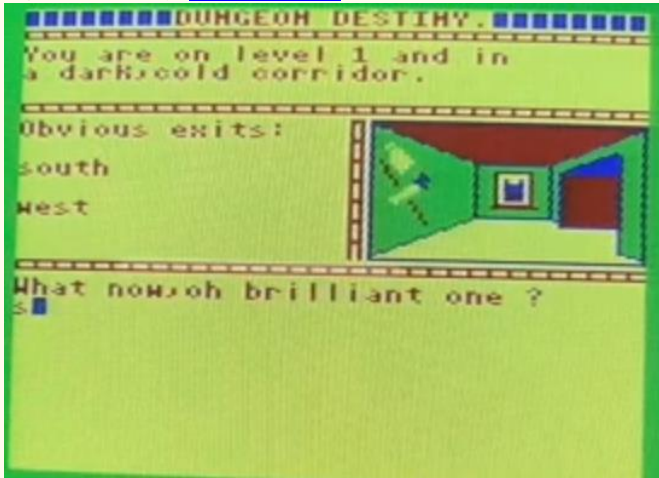

**DRAGON32 FROGGER**

Rob's Retro Rambles covers the official Frogger for the Dragon 32. [YouTube link](#)



**ROBOS VIDEOS INCLUDING ZAK'S SON**

Robos (From Poland) did a video of Dragon games starting with "S". [YouTube link](#), And W,Z (new: White Crystal. Zax's Son) [YouTube link](#), And R. [YouTube link](#)



**MAME DEBUGGING INTRO**

Tim Lindner put up a video showing how to use the MAME debugger when emulating a CoCo, using Arkanoid as an example. [YouTube link](#)

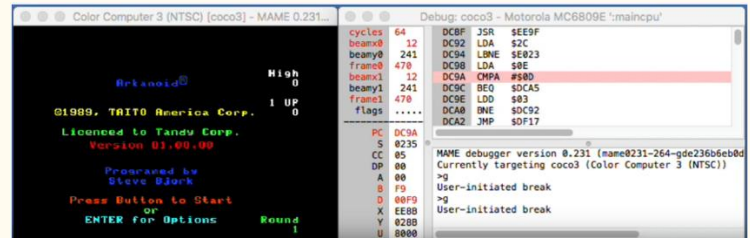

**SG24 COLOR MIXING**

Simon Jonassen posted screenshots of mixed colors in SG24 without needing page flipping (before and after) by "wobbling" the screen using the VDG / SAM timing tricks we have mentioned on recent episodes. [Facebook link](#) He also posted a pic that uses page flipping techniques instead, but these tend to flicker a bit on real hardware. [Facebook link](#)

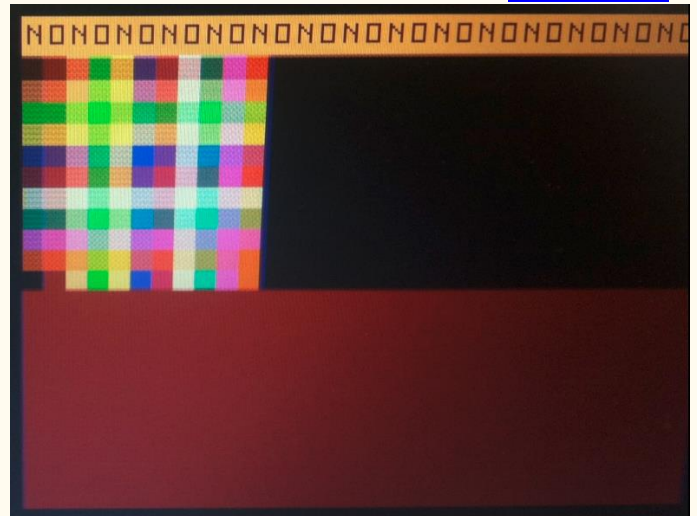

## PEPPER: SALT REPLACEMENT BOARD

Pedro ("Rocky Hill" on YouTube) put up a video showing that his replacement for the SALT chip for the CoCo 2 (which he is calling PEPPER) is working. [YouTube link](#)



## COCO3 GRAPHICS AND JOYSTICKS

Keith (Chibiakumas) has put up his 2nd CoCo 3 graphics assembly language video, showing how to map in and set a CoCo 3 graphics screen, use the MMU, read joysticks and do bounds checking on the edge of the screen (again using XOR software sprites, like his earlier Dragon/CoCo 1/2 episode). [YouTube link](#)

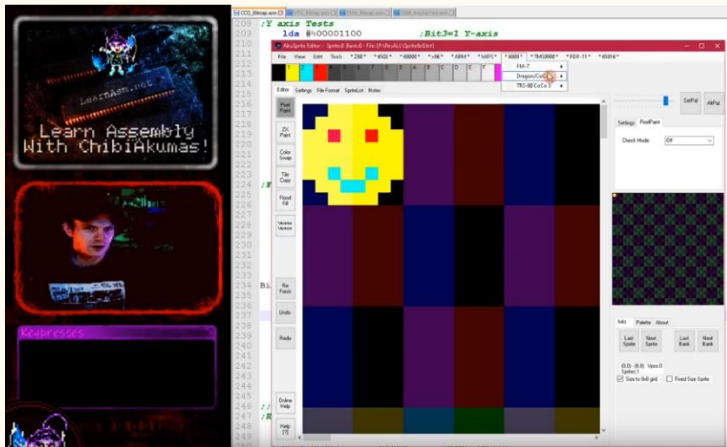

## NITROS-9 EOU BETA 6.1 FOR MATCHBOX AND MISTER

NitROS-9 EOU 6.1.0 has now been released for both the Matchbox CoCo and MiSTer CoCo 3 cores, (both of those cores are by Roger Taylor), and include the enhanced EOU with 80x60 text support by Bill Nobel. You can download it free here. [Website link](#)



## CRT KEN PROJECT UPDATES

Ken @ Canadian Retro Things on YouTube has put up his second video of working with the boards that he got from MrDave6309 on our Discord. 1st up is a 4 ROM bank switched Atari 8 bit game cartridge, and the 2nd is an Atari joystick adapter for the CoCo. [YouTube link](#)

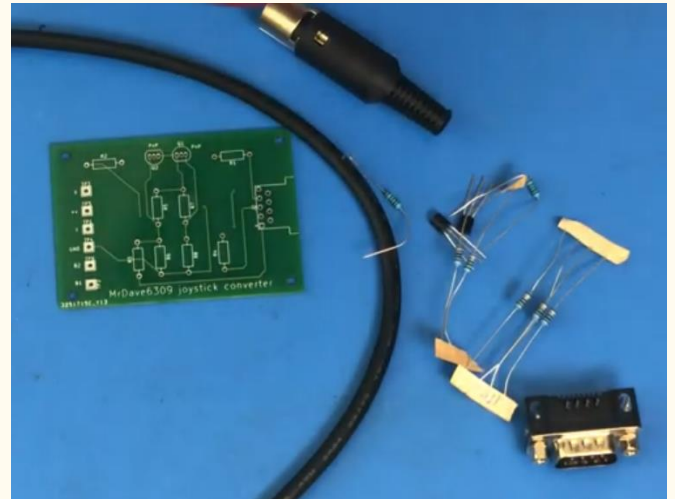

## DSKCON LOADER UPDATES

Sheldon MacDonald put up a video showing his progress on loading files from disk using assembly language, and only using the "legal" DSKCON routines/API's. [Facebook link](#)

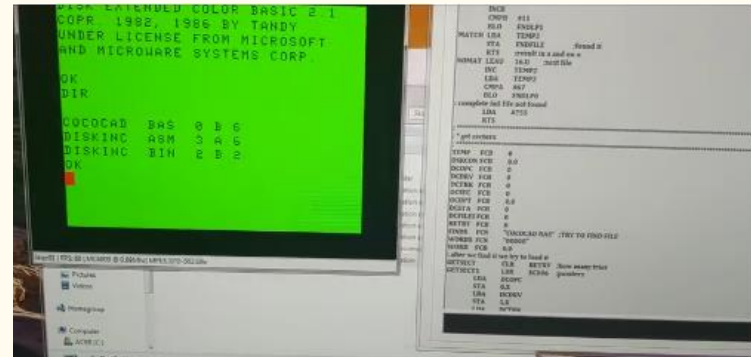

## RON'S 10 COCO UTILS

Our own Ron Delvaux put up a disk image (on his Ron's Garage Facebook page) of 10 CoCo 3 utilities, that you can download. [Facebook link](#)

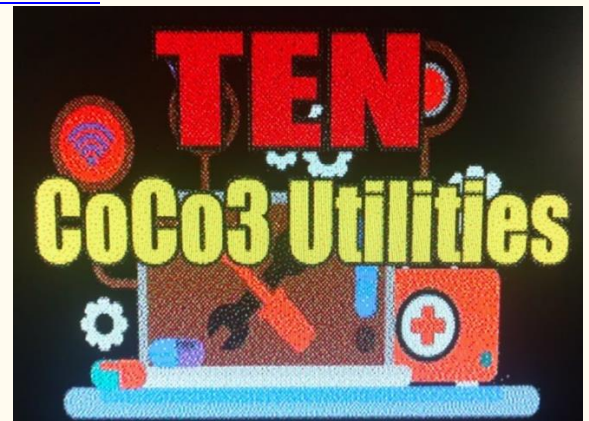

## MC-10 WORLD GEOGRAPHY

Jim Gerrie converted an educational program (World Geography) originally written in French for the Alice (MC-10 clone) computer in France to the MC-10. This includes information about the solar system, earth, etc. in a low res graphics presentation, with quizzes at the end. [YouTube link](#)



## MC-10 DALICE EMULATOR

Robert Sieg points out that the MC-10 emulator "DCALICE" (which also emulates the Alice 4K, Alice 32 and Alice 90 computers) also emulates the "MCX-32-FDJ floppy controller developed by Darren Atkinson" (Version 20.5.2020). [Facebook link](#) You can download it here (webpage is French). [Website link](#)

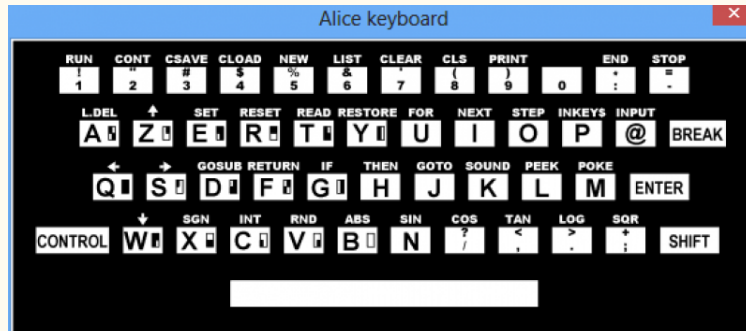

## MC-10 TEXT EDITOR

Darren Ottery uploaded a Text/SG graphics editing tool for the MCX32-SD for the MC-10, [Facebook link](#) Direct. [Download link](#)

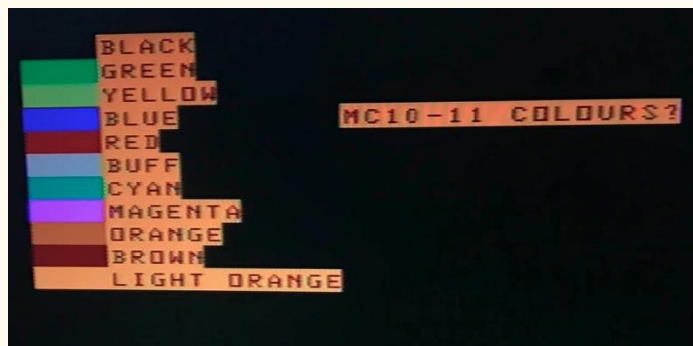

## DRAGON MSX2 BOARD LAUNCH DATE

John Whitworth announced that 3 new Dragon MSX2: boards were almost ready to go out as of May 15 (this past Saturday). [Facebook link](#)



## COCO SHOW 20: SPRINGSTER

Episode 20 of the The CoCo Show is now available on YouTube. They cover the CoCo 3 game Springster this month. [YouTube link](#)

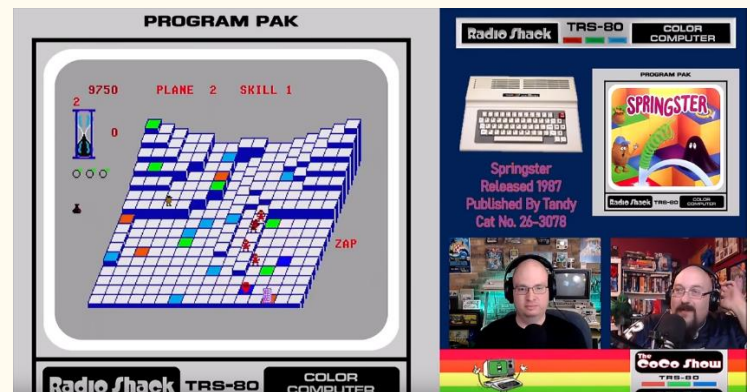

## MC-10 P.R.E.S.T.A.V.B.A.

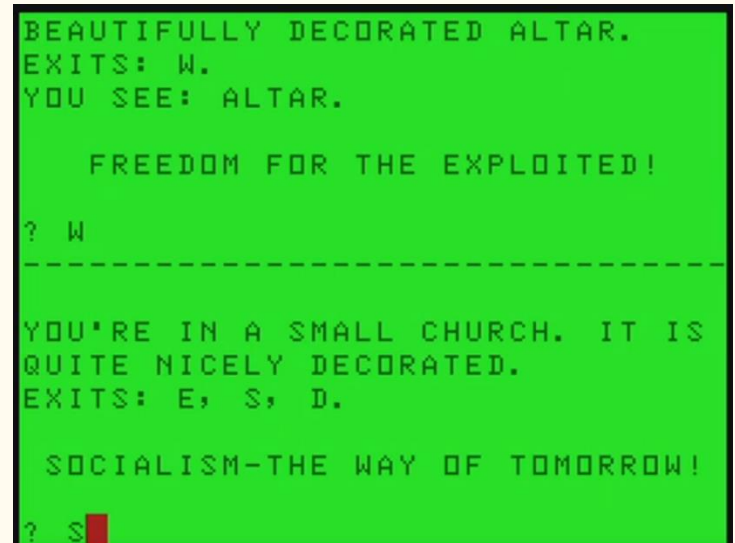

Jim Gerrie has a video up for a text adventure game that is labelled as "anti-soviet", and a port of the original made in 1988 by Czech programmer Miroslav Fidler, called P.R.E.S.T.A.V.B.A for the MC-10. [YouTube link](#)

### CUTHBERT DRAGON DICKIE'S DEN AND UTOPIA

Some more Cuthbert Dragon videos that show other games that I have not seen before:

Dickie's Den. It is a game that is in the Manic Miner / JetSet Willy style, [YouTube link](#) Utopia. [YouTube link](#)

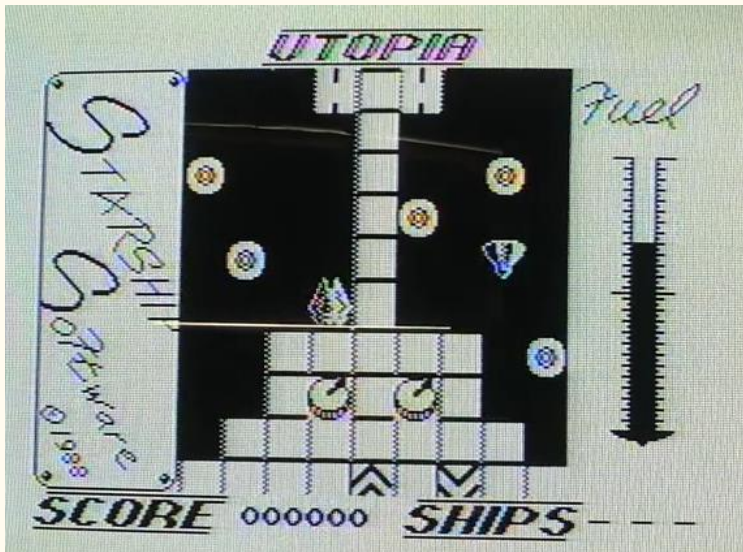

### 16TH VCF MIDWEST: SEPTEMBER 11-12

The 16th VCF MidWest in the Chicago area is now open for hotel bookings (an in person show!). September 11-12, 2021, some info here:

**Vintage Computer Festival Midwest 16 will be held September 11-12, 2021 at [Waterford Banquets](#), Elmhurst, IL**



Announcements

Contact Us!



### WORLD OF JANI

One of our newest members of the CoCo Discord, Jani, has a blog devoted to their retro computers, and since Jani recently acquired a CoCo 3, there is a now a Tandy/CoCo section on the site, which includes a capacitor list for recapping the motherboard, if needed. [Website link](#)

#### Tandy Color Computer 3 recap / capacitor list

Recap / Capacitor Lists, Tandy

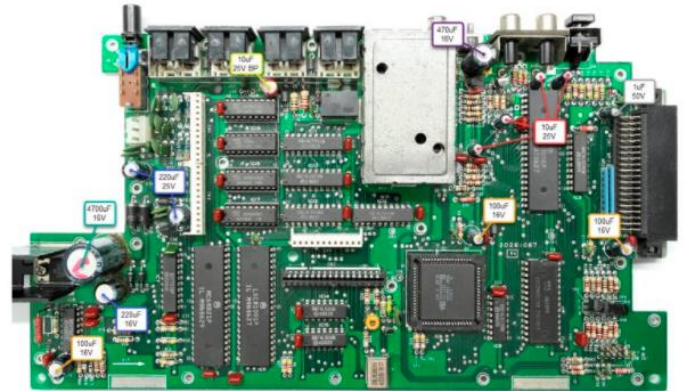

### TERRY STEEGE STEPS DOWN

A bit of sad news: Terry Steege has had to resign as Vice President of the Glenside Color Computer Club due to health reasons. We wish Terry the best, and thank John Mark Mobley for stepping up to take over for the remainder of the current term. [Website link](#)



### 12V FDC ON NEWER COCOS

Chris Burke posted pictures of the modification he did to the old 12 Volt floppy disk controller, to get it to run on a CoCo 3 (which only supplies 5V). [Facebook link](#)

### CRT KEN & TIG: COCOSDC ONE YEAR LATER

Ken @ Canadian Retro Things does an updated review of his CoCoSDC, almost a year after receiving it (which even has surprise guests including his cat Tig, and his offscreen twin brother). [YouTube link](#)

## SG24 UNDERLINES

John Laury put up an interesting posts showing how to use Semigraphics-24 to simulate an underline cursor on a CoCo 1/2. I remember the Hoyt Stearns Electronics CoCo version of the Forth programming language using this technique in it's built in editor, although it used Semigraphics-12 to save RAM (and at the time of it's release, the T1 VDG wasn't out yet so they didn't have to worry about descenders). [Facebook link](#)  
He also put up a short video on YouTube to demonstrate it. [YouTube link](#)

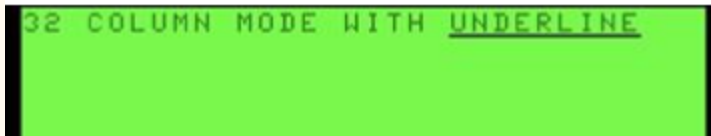

## BASIC SPANISH

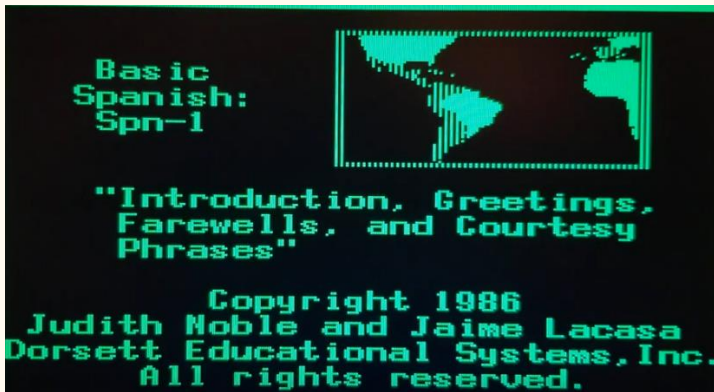

Michael Pittsley put up some videos of some rarer CoCo educational software on YouTube.

The Basic Spanish package from Dorsett Educational Systems Inc. (1986), is divided in multiple program modules, 16 in all and each with their own theme, and includes audio cassette multi-media like we have shown before, as well as monochrome graphics. Michael has put up 20 to 30 minute videos of all 16 modules on his YouTube page. [YouTube link](#)

## SC77526 SOUND ALTERNATIVES

Pedro (Rocky Hill on YouTube) put up a couple of quick videos of possible ways to replace the SC77526 chip for making sound, etc. on a CoCo 1/2 that he has been working on: Using a hex buffer and R2R ladder. [YouTube link](#) Using an Arduino uno. [YouTube link](#)

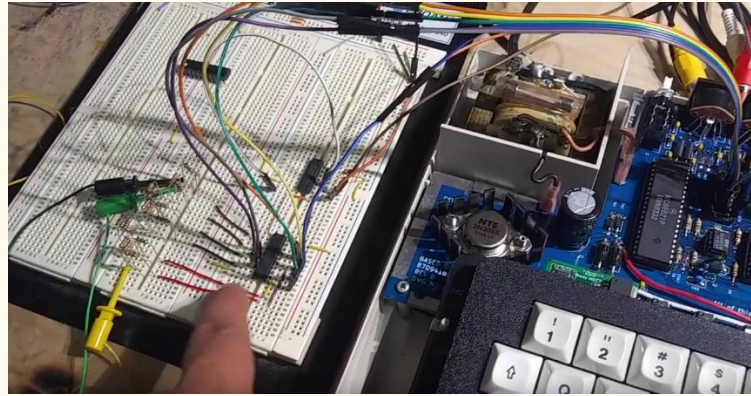

## ALICE EMULATOR INVESTIGATION

Robert Sieg has been experimenting with sample code for the later Alice's (when they went beyond MC-10 compatibility), and has been comparing various emulators for accuracy. From his testing so far, James Host's emulator is the most accurate covering the newer improved text modes and colors. Links are in the comments. [Facebook link](#)

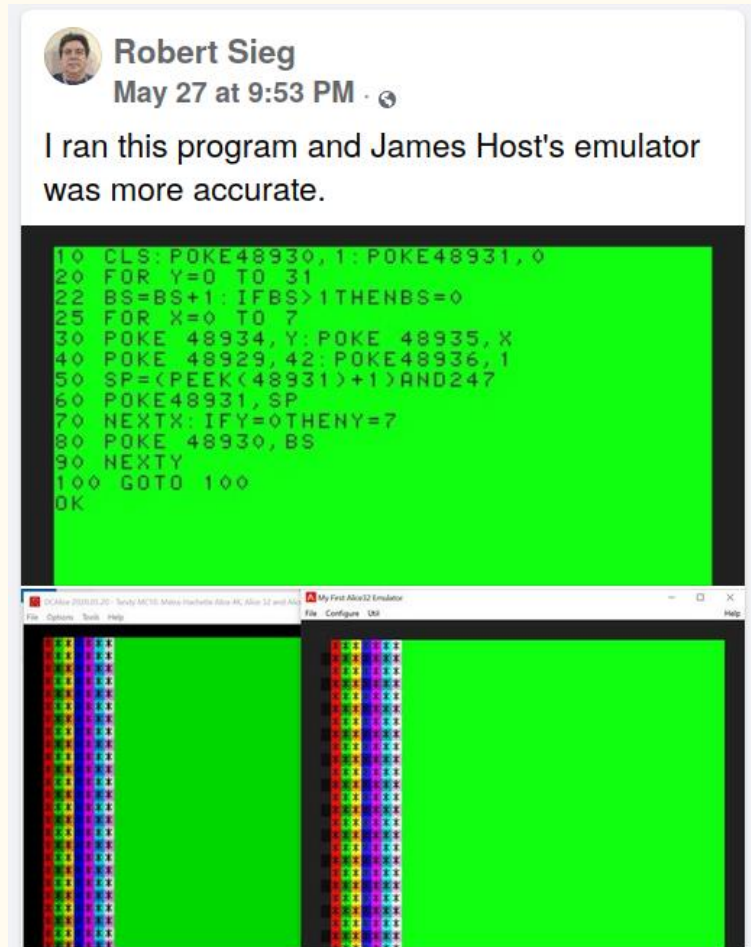

## DRAGON USB KEYBOARD

Richard Harding has posted a video showing phase 1 of his Dragon 64 USB keyboard in action, which will have many more features than just using a USB keyboard on a Dragon in future phases. He shows it currently running with XRoar, but the future plan is that it will work (with all of the extensions he mentions) on a real, modded Dragon 64 in the future. [Facebook link](#)



## DRAGON MEGAMINI MPI

Pere Serrat is working on getting the Mega-Mini MPI working on the Dragon, and with help from Ed, says that v0.25.13 of Dragon DOS Plus, that will support it with the CoCoSDC in Dragon mode, should be out next week (a lot of this is from the comments in the original post). [Facebook link](#)

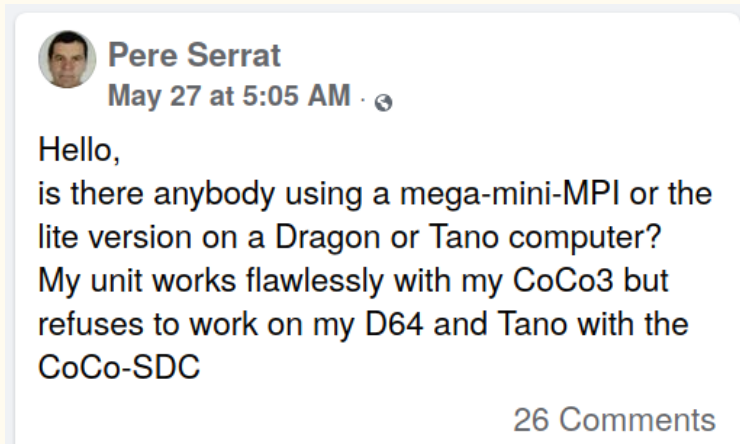

## DRAGON SWITCH REPLACEMENT

Dragon Data Archive on YouTube released a video on how to replace the Alps SKCC switches on a Dragon 64. [YouTube link](#)



## CUTHBERT DRAGON GAMING

Cuthbert Dragon has put up more Dragon gaming videos, including a few more I don't recall seeing before: 3D OXO (3D Tic Tac Toe, but with a bit of a Space Invaders theme, [YouTube link](#), Misers Dream, [YouTube link](#) Galactic Gus (not a fan of the sound, but looks like a good maze explore/collect treasure game). [YouTube link](#)

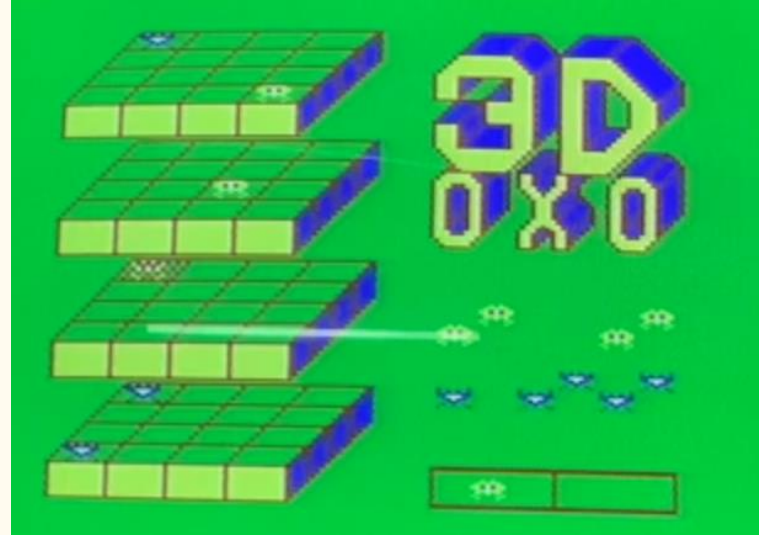

## MC-10 COLORIC

Jim Gerrie has ported the color strategy game Coloric from the Alice machines to the MC-10, based on the original by J. Dirani/Free Game Blot in 1984. [YouTube link](#) He also did a slight update to an earlier Demo port from the Alice to the MC-10. [YouTube link](#)



## ZERO HOUR #6

Nick Marentes has released Chapter 6 of his Zero Hour game development blog, this time going into sprite animation, compiled sprites, and animated elevators and fire. [Website link](#)

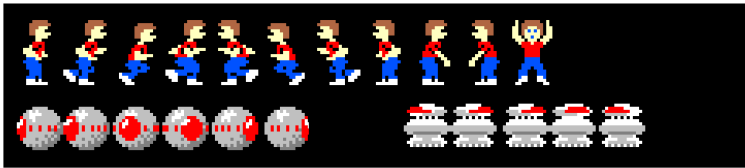

OLD GRAPHICS

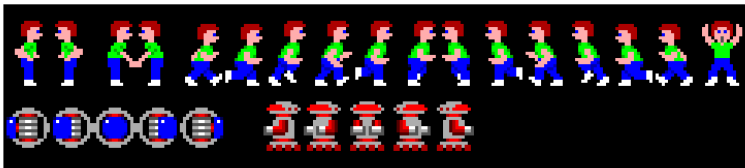

NEW GRAPHICS

## POWER SWORD HACKERS PACK

Richard Kelly uploaded an updated version of the game Power Sword, originally from T&D Software #34 (April 1985), which itself was based on Sword of Fargoal from the Commodore-16 & 64. This one has had typographical errors fixed, optimized code, bugfixes and improved game save/load. Available on the Files section of the main CoCo group on Facebook. [Facebook link](#)

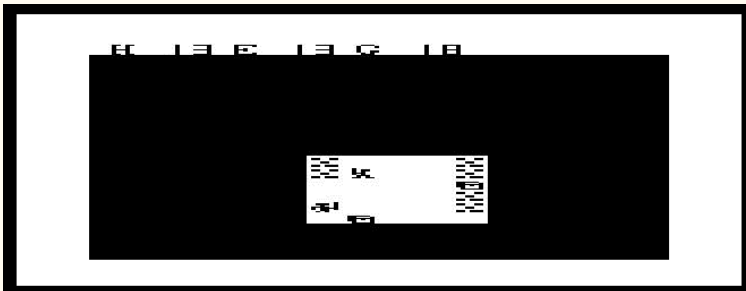

## CODIMEX 6809 ADVENTURE: O RESGATE (RESCUE OR RANSOM)

Daniel Scherer put up a 4 minute video of a graphical adventure game he did for the Brazilian CoCo clone, the Codimex CD6809, which includes a nice artifact colors (and is called "The Rescue" in English, I think). [YouTube link](#)

## O RESGATE Por Daniel Scherer 1989



## DRAGON 32 RING OF DARKNESS

La Quete des RPG on YouTube (who did a Daggorth video a couple of months back) has returned with a long play video of the Dragon 32 role playing game, The Ring of Darkness, done in his native French. The game itself reminds me a lot of the original BASIC version of Ultima 1 on the Apple 2, with the separate, distinct graphics for the main world map, the city/town maps, and 3D wireframe dungeons. [YouTube link](#)



## COCOCREW EPISODE 72 MAY 2021

The latest CoCo Crew episode dropped, which includes a tech segment on using hexadecimal from Extended BASIC, and a review of Thexder. [Podcast link](#)





## COCOIRC

Todd Wallace (Lord Dragon in our Discord) has released a video showing his IRC client running on his CoCo 3, under NitrOS-9 (also requires Drivewire). He also has it available for download for testing (Version 0.9 Beta at the time of this writing); the link to that in the video's description. [YouTube link](#) [Download link](#)

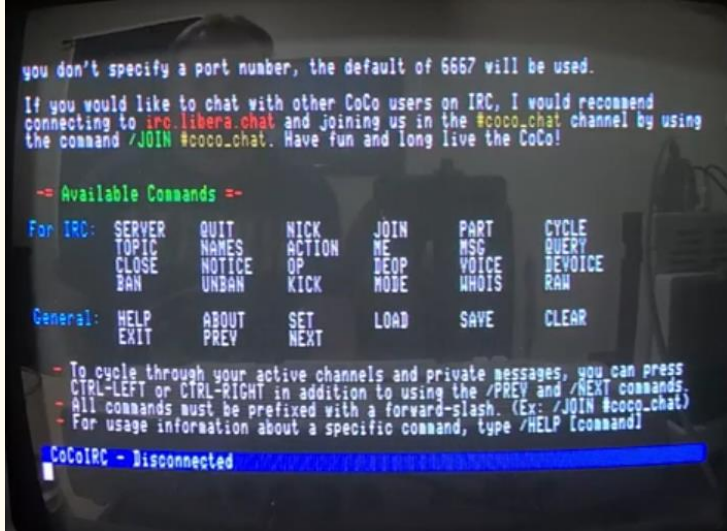

## LONG LOST TECH

Long Lost Tech on YouTube just announced that he is back online, and made a quick 10 second teaser video - using Deskmate on a CoCo 2. [YouTube link](#)



## AMBER'S VIBE CORNER

A channel on YouTube called "Amber's Vibe Corner" has released a couple of very short videos using EDTASM+ to write quick assembly routines. Not sure if this was started due to our new assembly language tutorial, or if that is just coincidence. [YouTube link](#) Turning on the G2R graphics mode. [YouTube link](#)

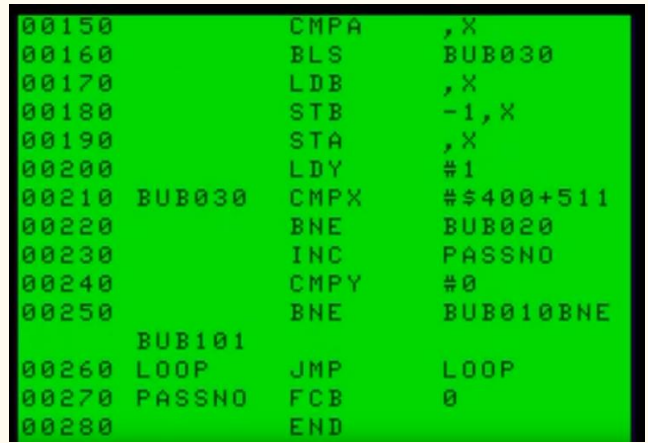

## ALICE32 GRAPHICS

Robert Sieg has been doing a ton of graphic experiments on the Alice 32 (one of the French sequels to the MC-10) using its better graphics and text modes (particularly using alternate fonts). [Facebook link](#)

Some different renders, showed along the original high color source and original lower palette bit map, then converted to color text. [Facebook link](#) [Facebook Link](#)



## DRAGON MSX 2+

John Whitworth has sent in the next version of his Dragon MSX 2+ upgrade graphics/sound board. [Facebook link](#)

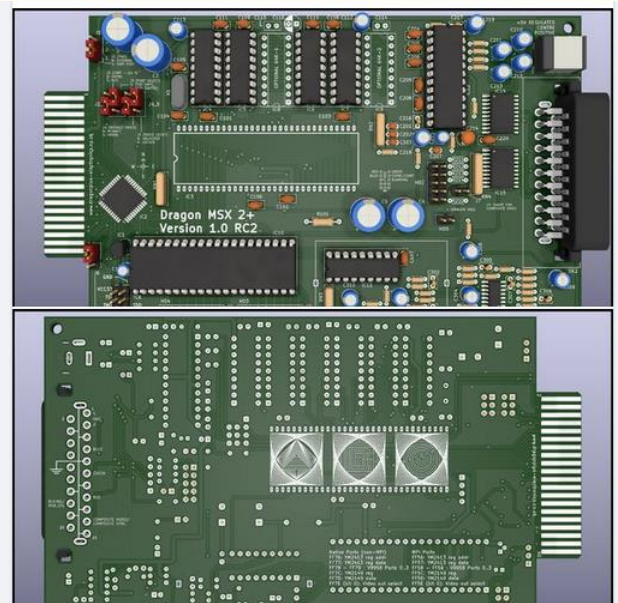

## forNDATA sUMMER 2o21

Patrik Gahm announced on the Dragon Facebook group about "forNDATA sUMMER 2o21" happening today (June 5) in Sweden. It's billed as an "oldschool party featuring C64, Amiga and other 8/16 bit computer platforms", and Patrik is hoping to see some CoCo and/or Dragon entries this year. They have some big name guest speakers as well (he would like to get CoCo/Dragon speakers to it for next year). [Facebook link](#)



## MISSION IMPROBABLE: OPERATION ALPHA

Jim Gerrie ported a game from the APF Imagination Machine to the MC-10 called "Mission Improbable: Operation Alpha". [YouTube link](#) He also used an APF Imagination Machine based game (which uses the same VDG as the CoCo 1) as the basis for a 10 line BASIC game called Defender (which is a Missile Command type game). [YouTube link](#)

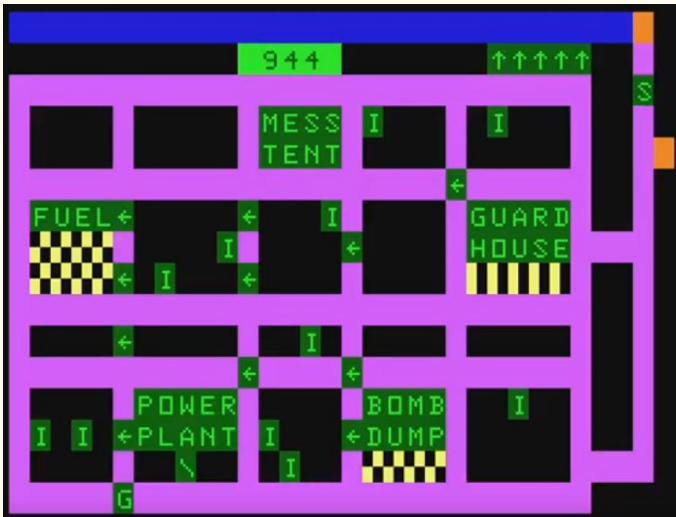

## 16-COLOR CARD DECK DEMO

Paul Shoemaker did a quick video on Facebook showing his new 16 color card deck design (using a 256x192 16 color mode). [Facebook link](#)

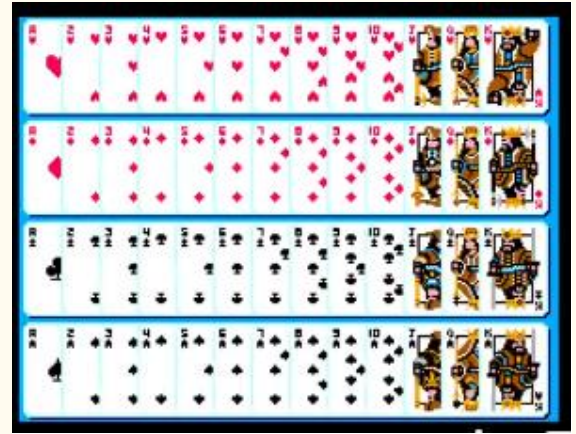

## HIBERNATE 1

Stefan Vogt announced on Twitter that the CoCo is going to be added to the list of old machines that will be able to run a port of his text adventure game (currently already on 24 systems!) called Hibernated 1. I think it is based on the famous Infocom engine (used by Zork, Hitchhikers Guide to the Galaxy, Witness, etc.). [Twitter link](#)

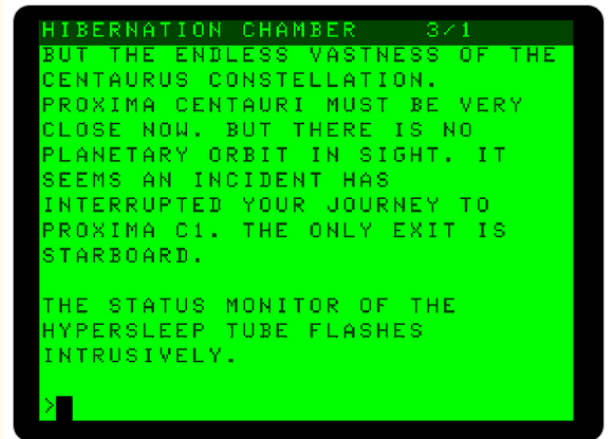

## THE SWORD AND THE SORCERER

Cuthbert Dragon put up more game play videos, one of which I have not seen before, which looks like a good dungeon crawler called "The Sword and the Sorcerer" (appears to be written in BASIC, but well done graphics). [YouTube link](#)

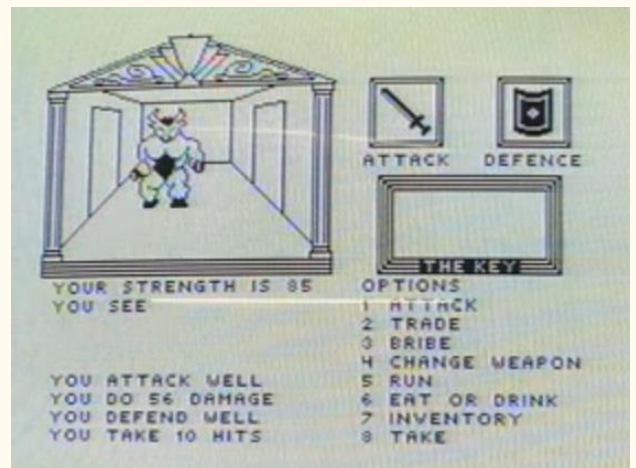

## Calendar of Events



### Glenside Color Computer Club, Inc. Business Meetings

Third Thursday of each month.  
7:30 PM to 9:30 PM Central Time

Upcoming meetings: July 15<sup>th</sup>, August 19<sup>th</sup>, and September 16<sup>th</sup> 2021. Check the calendar on [our site](#) for updates

BlueJeans Video Conference <https://bluejeans.com/889394355>

You can call in: Phone Dial-in +1.408.740.7256

Meeting ID: 889 394 355

### Vintage Computing Festivals:

<https://vcfed.org/wp/festivals/>

#### VCF West

August 7-8, 2021

#### VCF South East

August 20-22, 2021

#### VCF East

October 8-10, 2021

#### VCF Midwest

September 11-12 2021

#### Tandy Assembly

October 1<sup>st</sup> – 3<sup>rd</sup> 2021

<http://tandyassembly.com>

### The 29th Annual "Last" Chicago CoCoFEST!

Date: Scheduled for November 6<sup>th</sup> and 7<sup>th</sup>, 2021

Location: Holiday Inn Elk Grove, IL

<http://glensideccc.com>



Image courtesy of D. Bruce Moore

# CoCo Community Corner



## Source

Glenside Color Computer Club, host of CoCoFEST!  
The TRS-80 Color Computer Facebook Group  
The Color Computer Mailing List  
The TRS-80 MC-10 Facebook Group  
The CoCo Crew Podcast  
The Dragon 32/64 Communities  
CoCoTALK! Weekly live Color Computer talk show  
The CoCo Community Discord server  
The CoCo Show Podcast  
Looking for more CoCo Links? Visit I'm a CoCo Nut!

## Link(s)

[Website](#) | [Classic splash page](#) | [Facebook](#)  
[Facebook](#)  
[Website](#)  
[Facebook](#)  
[Website](#) | [Facebook](#)  
[Website](#) | [Facebook](#)  
[Get Discord](#) | [Server Link](#)  
[Website](#) | [YouTube](#)  
[Website](#)

## (Closed Parentheses)

Thanks to D. Bruce Moore for Joey & CoCo strip #8 "You Didn't Know?" and Salvador Garcia's latest entry of CoCo Chronicles

# JOEY & COCO

Why are you called a  
"Color" Computer when  
it's all shades of grey?



You mean...

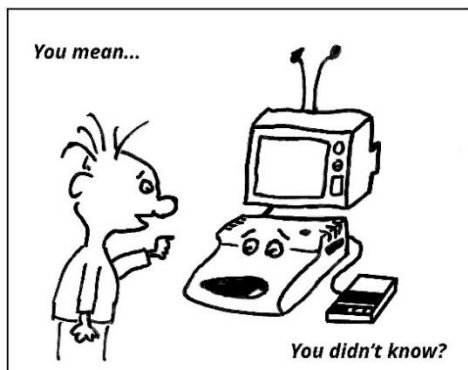

DAD!!!



(C) 2019 D. Bruce Moore

## CoCo Chronicles

Salvador Garcia

