

## CoCo 1/2/3

Glenside Color Computer Club, Inc.  
Volume 39, Number 2

Mebane, North Carolina  
Summer 2019

### Memory Map

Routines	Address
GCCC Officers	1
GCCC Information, Contributors	2
Contributors to this Issue, G.C.C.C Meetings	2
Trea\$ury Note\$, Editor's Clipboard	2
From the President's Platen	2
Secretary's Scroll	3
Glenside Officer Election Results	3
2019 Annual Glenside Picnic	4
Hail to the [editor in] chief!	6
Vintage Computing Festival Midwest photos	7
CoCo Happenings	14
Calendar of Events	15
CoCo Community Corner	16
Close Parentheses	16

### Upcoming Events:

Regular meetings have been moved to the 3<sup>rd</sup> Thursday of each month @ Brian Schubring's Home. The next GCCC meeting will be November 21<sup>st</sup>. The 29<sup>th</sup> Annual "Last Chicago CoCoFEST! Is April 18<sup>th</sup> - 19<sup>th</sup> 2020

### G.C.C.C OFFICERS

Here is the list of club officers and how to contact them. If you have questions about the association, call one of the officers for the answers.

POSITION	NAME	PHONE	PRIMARY FUNCTION
President	John W. Linville	919-744-8139	The buck stops here...
Vice-President	Tony Podraza	847-340-1801	Meeting planning, etc.
Treasurer	Brian Goers	708-805-1888	Dues and Purchasing
Secretary	Rich Bair	847-835-1309	Records and Reporting
Director	Tony Podraza	847-340-1801	CoCoFEST! Organizer
Librarian	Brian Goers	708-805-1888	Club Software Keeper
Editor	John Mark Mobley	847-409-8604	Newsletter Production
Assistant Editor	Salvador Garcia	708-344-3551	Newsletter Production
Newest Editor	Steve Strowbridge	772-380-8305	Taking over for John Mark

Copyright ©2019 Glenside Color Computer Club, Inc.



John Linville



Tony Podraza



Rich Bair



Brian Goers



John Mark Mobley



Salvador Garcia



Steve Strowbridge

CoCo~123 A Glenside Publication Since 1985

## CoCo~123 INFORMATION

CoCo~123 is the newsletter of the Glenside Color Computer Club. Your annual contribution of \$15,00 helps to keep our club going. Send your check to:

Brian Goers, Glenside Treasurer  
3312 Miller Avenue  
South Chicago Heights, IL 60411  
[briang0671@sbcglobal.net](mailto:briang0671@sbcglobal.net)

Our treasury provides newsletters and good times with fellow CoCo users at our Annual "Last" Chicago CoCoFEST! and our Annual Glenside Picnic.

Should you attend the Annual CoCoFEST! your annual contribution will be covered for that year.

## G. C. C. MEETINGS

The Glenside Color Computer Club meets the third Thursday of each month at Brian Schubring's home at 7:30 pm. If you need a map, see the following link:

<https://goo.gl/maps/2Mer1bXtTsqT5x2MA>

A social get-together we lovingly call "The Meeting After" always follows the meeting at a nearby restaurant.

Visit our website at:  
<http://glensideccc.com>

## CoCo~123 CONTRIBUTIONS

If you have any suggestions for the newsletter or would like to submit an article, please contact the CoCo~123 Newsletter editor:

Steve Strowbridge, Editor  
[ogStevieStrow@gmail.com](mailto:ogStevieStrow@gmail.com)

## CONTRIBUTORS TO THIS ISSUE

Rich Bair	John Linville
Salvador Garcia	John Mark Mobley
Brian Goers	Steve Strowbridge

## Treasury Notes

Treasure report for September 2019. The beginning balance on September 2019 was \$11,825.57. No debits. Interest of \$1.38 and Deposits \$14.04. The end of September month balance is \$11,840.99

Brian Goers, Treasurer  
Glenside Color Computer Club

## The Editor's Clipboard

We rely on folks just like you to help write articles for our newsletter.

John Mark Mobley, Editor  
Glenside Color Computer Club  
It's been fun editing this issue, thanks John Mark and Salvador for all of the content, Steve.

## FROM THE PRESIDENT'S PLATEN

Schools are back in session, temperatures have started to cool, and the leaves have begun to change color -- Fall is coming. The change of seasons heralds the next issue of CoCo~123, which demands content from the club President. So, how are things?

When last we met, I announced that the venue for CoCoFEST! would be changing. The folks at Heron Point are pursuing other interests with their venue, and we have outgrown it anyway. After a broad search, we have chosen for the 29th annual "Last" Chicago CoCoFEST! to occupy the Holiday Inn facility at Elk Grove Village, IL. Those that have been to VCF Midwest prior to this year may already be familiar with the new CoCoFEST! location. The new facility is more suited to our needs, and I believe that it will prove quite satisfactory for us all. For more information on CoCoFEST! please continue to check the Glenside website and other sources of CoCo news and information around the globe.

Glenside has been keeping the community together for decades now. The club is composed of volunteers, with a few elected officers with special roles and obligations. Those elections occur each year, and the time is nigh! Nominations for officers (President, Vice President, Secretary, and Treasurer) should happen at the next meeting on 12 September 2019, with the voting completing by 10 October. Watch the various source of CoCo news for information on how to submit your vote -- make your voice heard!

A few months ago, there were some tensions in the CoCo community. An expressed opinion had led to a misunderstanding, with more than its fair share of hurt feelings and recriminations. In the last edition of this column, I asked for people to "take a breath, relax, and find some time to play with your CoCo, Dragon, or MC-10." It is unclear now whether all those negative feelings have completely passed, but at least the overt hostility has been gone for weeks or even months now -- I, of course, take full credit as the peace maker! But seriously, it is good to see the community settle down a bit and for us to remember that we are all just here to have fun and enjoy each other's company while we can.

The CoCo community has been a part of my life for decades. I am gratified to see the community grow, even as it changes. Spats and full-on fights may be inevitable. But we can survive the conflicts, as our recent history shows. We can and will learn from the hurt feelings and continue strong -- together.

CoCo Forever!



John W. Linville, President  
Glenside Color Computer Club

## Secretary's Scroll

Rich Bair here with a summary of the last three monthly membership meetings:

Our July meeting was devoted to discussion of various ideas for improving next year's fest. Because we are moving to a different venue some changes are possible which were not possible previously, but the reverse is also true. We may have space for a quick-registration line for people who preregister and prepay, but on the other hand we may not be able to accept payment for the dinner at the registration point. In other words, it may be a requirement that you prepay for the dinner if you wish to partake.

The Chris Hawks' family has moved out of state to Tennessee and Tony Podraza is also planning such a move. Since they are two who have signing authority on our checking account, we decided to give that authority to two of our local members.

The August meeting focused on details of our relationship with the new venue (the Holiday Inn of Elk Grove Village, or HIEGV), and ideas for the theme for next year's FEST. We also set a date and location for our annual picnic: September 21st (sandwiched between VCFMW on the 14th and Tandy Assembly on the 28th) at Brian Schubring's home, same as last year.

At the September meeting it was announced that our original "official" web page, now nicknamed the "Splash" page because of its colors, and designed and updated by Bob Swoger, has been rescued and now lives at:

<http://retrotechtime.com/glensideccc/Splash.htm> and, of course, the official Glenside website is still at <http://glensideccc.com>

We set entry fees for next year's FEST to be mostly the same as last year.

We manned a booth at VCFMW.

Nominations for elective offices for the next year were:

President: John Linville, Eric Canales  
Vice-President: John Mark Mobley, Terry Steege  
Secretary: Rich Bair  
Treasurer: Brian Goers

Voting will take place at the October meeting, and non-local members will have the option of voting securely and privately at Tandy List website if they are members in good standing. Simply click on the link below, login and then click on the VOTE icon at the top of the page. You will then be presented with the ballot used to vote. Make your choices and submit your ballot.

<https://www.tandylist.com/>

The theme of next year's FEST was discussed. Tony Podraza is working with the idea of a combination of 2020 (the year), 20/20 (the perfect vision spec.), and the 40th anniversary of the CoCo (=20+20). Help us out with ideas or graphics.

The change of venue for next year has brought up several thorny questions regarding our traditional Saturday dinner. The Holiday Inn offers catering service, but their "list" prices for some of the plated dinner choices are nearly three times the \$20 we charged last year. Buffet style is an option; "list" price for it is \$48. We might be able to have the caterer we used last year come in, but HIEGV may not allow that since they have their own in-house system. The club is considering subsidizing the dinner; the Holiday Inn hints that a rebate of some of the dinner expense is likely. Many decisions need to be made; nothing is final yet. We have appointed a dinner committee to hash some of this out. But feel free to direct your comments to any of us; we will listen.

Happy CoCoing!



Rich Bair, Secretary  
Glenside Color Computer Club

## Glenside Officer Elections Results



By Steve Strowbridge

The nominations were submitted, the voting took place, and we are pleased to announce and congratulate:

- Eric Canales, President
- John Mark Mobley, Vice-President
- Rich Blair, Secretary
- Brian Goers, Treasurer

Steve Strowbridge has agreed to take over editing the newsletter for John Mark Mobley



## The 2019 Annual Glenside Picnic



By John Mark Mobley

A great turn out of members attending this year. The food was great, and everyone enjoyed themselves. The event was also live streamed for the benefit of other community members who could not attend.



Margaret Siber, Rich Bair and Wayne Pritzel enjoy each other's company during dinner time.



Tony Podraza checking out the web after cleaning off his plate. His son Chris also attended.



Eric Canales, one of the candidates for the position for president, also attended our picnic. Eric is one of our members that stores items for our CoCoFEST! auction.



Besides all the pass-arounds brought by the attendees, tube steaks and ...



## The 2019 Annual Glenside Picnic



...hamburgers were supplied by the club as we have been doing for years.



Tony Podraza and the Mobley's brought Mirai Sweet Corn just hours from the field in Harvard, Illinois. Mirai sweet corn is a hybrid that has changed the meaning of sweet corn. Deemed the sweetest, most tender, and flavorful corn available by customers worldwide. Only two left at the end of the day? They must have been for Annette and me - we weren't there that day!



In previous years Brian would give us a flight show from his model aircraft collection. This year he let us fly his flight simulator.



Left-to-Right: Chris Podraza, Mrs. Kim Schubring, Brian Goers, Brian Schubring

## The 29<sup>th</sup> Annual "Last" Chicago CoCoFEST!

## Make The Trek!



Image courtesy of D. Bruce Moore

Here are the 5 "W's"

**WHO?** Glenside Color Computer Club, Inc, PRESENTS  
**WHAT?** The 29th Annual "Last" Chicago CoCoFEST!  
**WHEN?** April 18-19, 2020  
Registration & sign-in: (Sat, 8 am-9 am)  
Show: (Sat, 9 am to midnight - Sun, 9 am-3 pm)  
**WHERE** Holiday Inn Elk Grove Village  
1000 Busse Rd  
Elk Grove Village, IL 60007

(New location from 2019!)

Overnight room rate:  
\$99 plus 13% tax (\$111.87 Total)  
Call 1 847- 437- 6010 for reservations.  
You must ask for the "CoCoFEST!" rate or  
Group Code: CCF.

>>> YOU MUST REGISTER UNDER "CoCoFEST!" <<<  
>>> TO GET THIS RATE <<<

### WHY?

A. To provide vendor support to the CoCo Community  
B. To provide Community support for our CoCo Vendors  
C. To provide educational support to new users.  
D. TO HAVE AN OUTRAGEOUSLY GOOD TIME!!!

And now, the "H" word,

**HOW MUCH?** All Attendees - General Admission  
Saturday: \$15 1st - \$10 2nd & more  
Sunday: \$10 1st - \$5 2nd & more

\*\*\*\*\* Children 12 and under - FREE \*\*\*\*\*

\*\* Students 21 and under with valid Student ID - FREE \*\*

Be sure to visit our Website to see up-to-date  
information on upcoming events, <http://glensideccc.com>

For further information, general or exhibitor, contact:

Tony Podraza, GCCCI  
847-340-1801, VOICE  
[tonypodraza@gmail.com](mailto:tonypodraza@gmail.com)

Robert Swoger, GCCCI  
630-847-7026, VOICE  
[rswoger@aol.com](mailto:rswoger@aol.com)

## Nail to the Editor in chief!

By Steve Strowbridge

The October GCCC business meeting announced the new officers for the 2019/2020 year, and I want to share my heart felt congratulations to John Mark Mobley for being nominated and voted in as the new Vice-President. His commitment to the club, especially in the area of public relations is commendable. The need for a newsletter editor opened, and I was delighted at the opportunity to have a more direct, hands-on role in assisting Glenside and CoCoFEST! Boy! What did I get myself into! As I'm in the process of editing my first issue, I realize the tremendous responsibility of maintaining the legacy of this great publication which goes back to 1985.

There is a lot of history and tradition, not to mention information in these publications, and I hope I can keep the bar as high as it's been held all these decades. While maintaining the content, overall format, and respecting the legacy of this publication are paramount, I hope we can also bring some gradual improvements into some of the cosmetic components, as well as improving and increasing the overall content.

The CoCo is our computer, GCCC is our club, CoCoFEST! Is our annual event, What makes these all great? Us! CoCo~123 is an extension of all this greatness, and, with "our" help, by ways of suggestions, and contributions, I hope this publication will remain as amazing as the CoCo and the people who gather together to share the love.

We look forward to suggestions and contributions from all the members of the Coco community, so please feel free to send me one of those electronic mail messages to [ogStevieStrow@gmail.com](mailto:ogStevieStrow@gmail.com)

Long live Glenside, Long live the CoCo, Long live CoCoFEST! Long live CoCo~123.



# Vintage Computer Festival Midwest 14 Through Pictures



by Salvador Garcia

Hello CoConutz!

The Tandy/Radio Shack line of computers was well represented at the Midwest Vintage Computer Festival 14 (henceforth just VCF). There was a strong presence of the Color Computer Community. Among those present were Steve Strowbridge, live streaming parts of the show, Tony Podraza, John Mark Mobley, Henry Reitveld, David Ladd, Richard Lorbieski, Grant Leighty, Thomas Czaplinski, Jim Brain plus his daughter Belle, Eric Canales, Jason Reighard, Neil Blanchard, Brian Goers, Evan Wright, Brian "The Music Man" Schubring, Tim Franklin, and yours truly, Salvador Garcia. If I missed someone, my apologies.

On Friday, a few of the CoCo community ventured out into the wilds of the Chicago 'burbs in search of the elusive Fire & Wine pizzeria. After some cunning navigation led by a GPS, the group zeroed in on the target and proceeded to wait about 30 minutes before they finally let us in.



We celebrated successfully locating the Fire + Wine pizzeria. From the left, with the guy wearing the green fluorescent shirt: David Ladd, David Murray, Jason Reighard, Grant Leighty, Steve Strowbridge, Salvador Garcia, Eric Canales, Tom Czaplinski & Rich Lorbieski



Brian "The Music Man" Schubring at the Glenside Color Computer Club table..



Another shot of the Glenside Color Computer Club's table. Henry Reitveld showcases some of the items that he brought, including a Tandyvision console and a CoCo 3 connected to a light gun.



A notable item that was for sale at the show was the official VCF 6502 badge. I was told that another vendor of the 7 segment LED display was found, so the designer decided to make one more run of the PCBs. Kits were being sold for \$25. These included the PCB, and some of the discrete components. Notably missing were some of the integrated circuits (ROM, RAM, CPU).

This badge has been sold at other VCF shows, including those abroad. One of the shows sold roughly 500 of these ingenious 6502 computers! I wouldn't be surprised if the total number of badges sold reached or surpassed 1,000 units.





This is RETRO Innovations' booth, minus Jim. He had several computers on display, including a Commodore C64, C64C and a Color Computer.



A Tesla coil, plus even more items on display at the RETRO Innovations booth, including a Hewlett Packard 200LX handheld computer.



A Commodore C64 connected to a tiny TV. To the right is a tiny scale model of a game room.



A Color Computer at RETRO Innovations booth. Other items for the CoCo are showcased here, including a CoCo SDC, and some of Jim's products, such as the ChameleonCart.



This is a Commodore C64C on display at the RETRO Innovations booth.



Belle with her delicious snacks. She's been so successful that Jim's booth might end up being renamed Belle's Pastries plus some Computer Stuff.





A close up of the CoCoSDC, ChameleonCart and the Philharmonic 12, a clone of the Symphony 12 (bottom right), Jim mentions that he is looking for people to test this new CoCo cart to verify that it is working properly. If you'd like to help out, contact Jim.

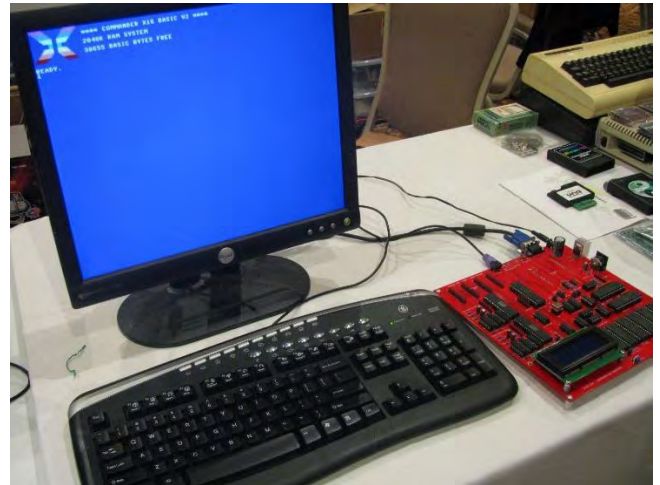

The Commander X16 computer. The graphic at the top left corner of the screen is a stylized butterfly that mimics the "X" in the computer's name and is the official X16 logo. I entered the World's Smallest BASIC program and it worked as expected, although my programming skills (or lack thereof) for this computer really showed. How do you clear the screen?



This is David Murray's booth. Here he showcases some Commodore Computers and his Commander X16 computer.

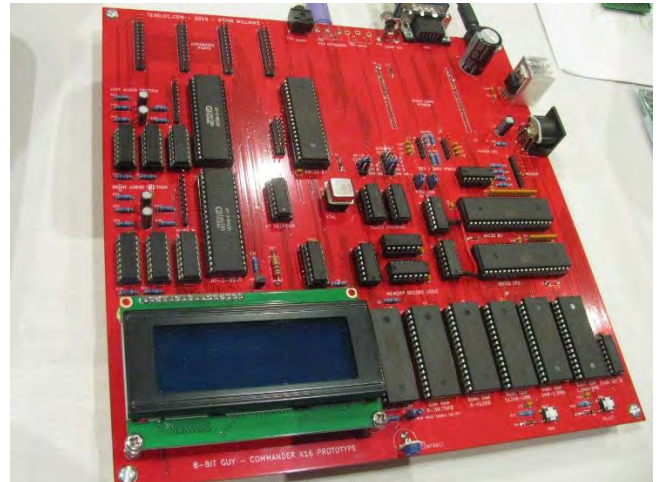

A close up of the Commander X16 motherboard.



Here is David sporting his 8 Bit Guy Tee and behind him the Commander X16 computer.

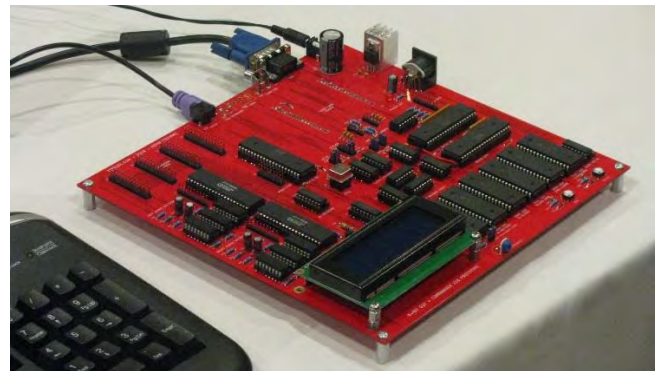

And yet another shot of the Commander X16 computer. For more detailed information about this computer, check out David's YouTube video at <https://youtu.be/sg-6CJzzg8s>. This is the second part; the first part discusses proof of concept and provides the thought processes that went into creating the X16.





Malcom Ramey's booth presented various models of private label TRS-80 systems. The pictures that follow showcase each model.



Of course, the Model 1 can't be left out. This is the classic Z80 computer that came out of a computer club and was the first of many personal computers designed and commercialized by Radio Shack.





Radio Shack added the expansion port to the Model 1. This allowed more RAM and connectivity to external devices such as floppy drives, printers and cassette recorders. More information about this interface here: <http://www.trs-80.org/radio-shack-expansion-interface/>



Another shot of the two booths. The Tano Dragon is lurking behind some promos and under a plastic bag. A Portillo's restaurant is conveniently located about 5 minutes north of the VCF venue and is a favorite and Chicago tradition. (And yes, they do sell other stuff besides hot dogs.)



David Ladd (left) and Tony Podraza hard at work. So much retro-information to share, so little time! A Color Computer is front and center. The small electronic card on top of it is a joystick/keyboard adapter. Just right of the CoCo is an MPI decked out with various carts. Note the use of a modern VGA display that proudly displays a NitrOS9 screen.



David Ladd at the Ease of Use (EOU) booth. The EOU project seeks to simplify the installation, setup and use of the NitrOS9 operating system. This booth had promos for various products and events, such as the CoCoSDC, the GunStar game, keyboard adapters and of course CoCoTALK! Note: The Portillo's bag is just David's lunch. More information about the EOU project here: <http://www.lcurtisboyle.com/nitros9/nitros9.html>



Another shot. Here David attentively listens to someone visiting the booth.



Richard Lorbieski's booth. He can fix your CoCo and make it better stronger, faster.





Henry Rietveld at the Glenside Color Computer Club booth. He brought a Tandyvision game console. A favorite item with attendees was his light gun. Henry has been active in the CoCo community, integrating software into images, enhancing the SDCX software, experimenting with different CoCo emulation platforms, and producing a plethora of videos documenting his adventures. Thank you Henry!



Richard Lorbieski's workstation, minus Richard. He commercializes a few Color Computer products and provides repair services for ailing CoCos.



Another shot of Richard's improvised workshop, ready to go. There isn't an inflated cap that can't be replaced, a 6809 that can't be extracted, nor a CoCo that can't be fixed (almost). If your CoCo is in peril, never fear, Boyson Technologies is near.



Richard Lorbieski, ready for any electronic mishaps that may occur. Richard commercializes a 512KB and 2MB RAM board called the Boomerang E2 and is the heart (and brains) behind Boyson Technologies. Visit his product page here: <https://boysontech.com/>



The Glenside Color Computer Club's newsletter, Coco ~123, editor at large, hunting down the next big scoop for the forthcoming issue. Nothing escaped his eagle eye in the quest for the next article.

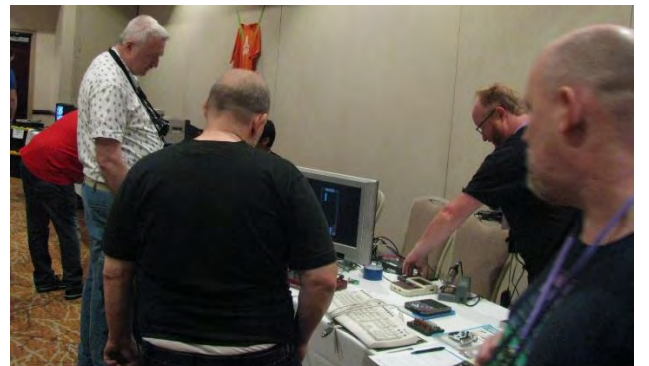

John Mark Mobley doing some research for the newsletter. Oh, look! To the right of him, behind the table is Ben Heck! Who is this you ask? Search for him on Google and YouTube. He had a very popular show on Element 14 called The Ben Heck Show.





Eric Canales (left) and Neil Blanchard. They both had a table at the show. Neil is one of the CoCo Crew, a popular podcast that discusses everything CoCo, plus more. Past and present podcasts can be found at <http://www.cococrew.org>. Eric is local and showcased various CoCo related items at his booth, along with a laser disc player. He is one of the candidates nominated for president of the Glenside Color Computer Club.



Jason "Cocoman" Reighard promoting his Switch-a-Roo RGB video to HDMI converter. This is a unique solution to display the CoCo 3's screen on a modern flat screen. The Switch-a-Roo cable connects the Color Computer 3 to a SCART to HDMI converter that in turn connects to the TV/display (with an HDMI input obviously!) Another product of his is the Wallab-Y-Cable. This cable allows two RGB displays to connect to the CoCo 3. He also had his newest product, Kookaburra, a 3-foot RGB extension cable.

### Farewell

We all look forward to next year's event. VCF keeps getting bigger and bigger. There is no lack of vintage computer and non-computer devices. Come and expect to see Ataris, Commodores, Apples, S100 systems, and many others. The Tandy/Radio Shack presence slowly, but surely, keeps growing.

My only regret is that I was not able to get a pic of Steve Strowbridge. He was busy streaming the event live. Check out Steve's coverage of VCF 14 at this link: <https://youtu.be/dyXjHa7xrVg> Beware! The coverage is over 4 hours long!

And so, as the weekend comes to close, we bid farewell to VCF 14, alas we knew thee well, but with the knowledge that just as Frosty, it will be back next year



Front Row: John Mark Mobley, David Ladd, Richard Lorbiecki, Brian Schubring  
 Center: Tom C, Grant Leighty, Eric Canales  
 Back: Jason Reighard, Steve Strowbridge

# CoCo Happenings



By Salvador Garcia



2019-10-08 Ed Snider posted some concept art for the future CoCo 2 Plus.

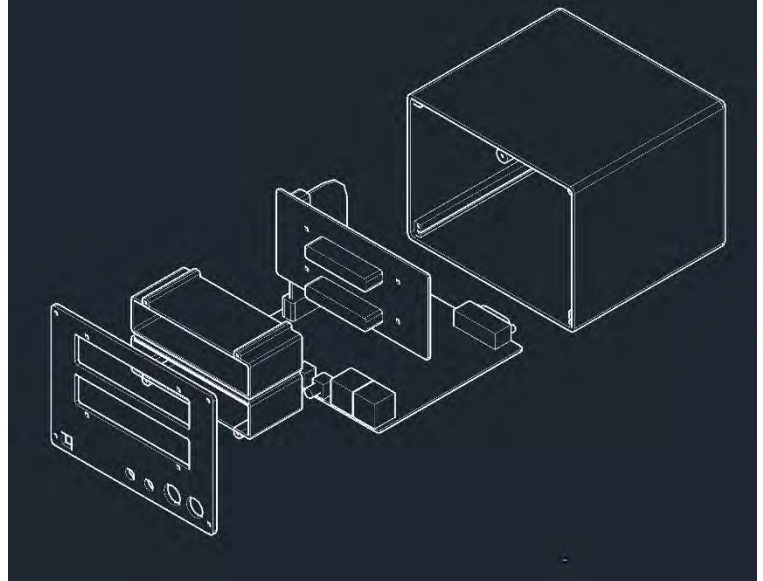

2019-10-06 Roger Taylor announced that he is working on a CoCo channel on Roku. When this project is finished, a CoCo emulator will be seen as an app on Roku. The user will be able to install and interact with the emulator as though s/he were using a CoCo! Bring it on Roger! More info will follow as this project develops.

2019-10-01 Ron Klein announced the availability of the latest version of MAME, v0.214, for the CoCoPi3. Files available at his Github page:

<https://tinyurl.com/yxkp74kp>

See 2019-09-12 entry for installation notes.



2019-10-01 Sheldon McDonald presented his mini controller for the CoCo. It connects to the joystick port. His plan is to bundle them with games he'll make available, and possible sell them for roughly \$10USD individually.

2019-09-13 Stephen Fischer provided a link to Michael Kent's eBay item that is a capacitor replacement kit for the Color Computer 2 and 3:

<https://tinyurl.com/y45vd88w>

2019-09-13 Steve Strowbridge announced that he will be live streaming parts of the Vintage Computer Festival that is this coming weekend, Sep. 14 and 15. Since this note is being written on Sep. 17, the video is now available at the following link:

<https://youtu.be/dyXjHa7xrVg>

2019-09-12 Ron Klein announced that the next release of MAME, v0.213, for the CoCo Pi3 project is now available for download. He now has this application configured so that the user can download and upgrade his or her CoCo Pi 3 directly within the Raspbian environment of the Pi 3. Links follow:

<https://tinyurl.com/y4n4cot5>

Instructions on setting up git to do the upgrade:

<https://tinyurl.com/y2ee9x8m>

2019-08-14 Henry Rietveld shared a link to a video by The 8-bit Guy where he talks about tech support while working at AST and Tandy/Radio Shack:

<https://youtu.be/2hdazA-VUf0>

2019-08-11 Carlos Camacho announced that he completed uploading the entire collection of Dynamic Color news magazine (minus one issue). Special thanks to Steve Ostrom for providing the original content and to Carlos for doing the scanning. Download link:

<https://tinyurl.com/ybfugd3p>



<p>2019-08-05 Ron Klein announced that the next release of MAME, v0.212, for the CoCo Pi3 project is now available for download. He now has this application configured so that the user can download and upgrade his or her CoCo Pi 3 directly within the Raspbian environment of the Pi 3. Links follow:</p> <p><a href="https://tinyurl.com/y3r93seh">https://tinyurl.com/y3r93seh</a></p> <p>Instructions on setting up git to do the upgrade:</p> <p><a href="https://tinyurl.com/y2ee9x8m">https://tinyurl.com/y2ee9x8m</a></p>	<p>2019-07-28 Luis Fernandez announced that he continues to work on the VCC emulator. He is adding a more complete keyboard, numeric keypad functions and other keys, support for the distribution of international keyboards and other things.</p>
<p>2019-07-26 Henry Rietveld shared a link to his video where he documents how he turns his audiotape software into MP3s:</p> <p><a href="https://youtu.be/XFuJtHvZH_w">https://youtu.be/XFuJtHvZH_w</a></p>	<p>2019-07-17 Henry Rietveld shared a link to his video where he presents his Tano Dragon setup using the SDC:</p> <p><a href="https://youtu.be/rCwlyYvJwnk">https://youtu.be/rCwlyYvJwnk</a></p>
<p>2019-07-17 Henry Rietveld announced that he finished putting together an SDC image containing SDCX and over 300 disk images. These include games for the Dragon. If interested, contact Henry directly for the Zipped image. (If you can't locate his email address on our Splash page, email the newsletter and we'll help you out.)</p>	<p>2019-07-01 John Linville announced the availability of episode 49 of the CoCo Crew Podcast. Since then, episodes 50 and 51 have also become available. Listen to the podcasts and read the episode notes here:</p> <p><a href="http://www.cococrew.org/">http://www.cococrew.org/</a></p>
<p>2019-06-30 Allen Huffman reminded us that there are some CoCo related extensions for the Microsoft Visual Studio Code Editor (MS VSCE). This is a specialized code editor (not an IDE) that is available for Windows, Linux and Mac. Get the free editor at this link:</p> <p><a href="https://code.visualstudio.com/">https://code.visualstudio.com/</a></p> <p>Color BASIC and 6809/6309 extensions are here:</p> <p><a href="https://tinyurl.com/y3vsoua7">https://tinyurl.com/y3vsoua7</a></p>	

## Calendar of Events



By John Mark Mobley and Salvador Garcia

**Glenside Color Computer Club, Inc. Business Meetings**  
 November 21st, 2019, watch our calendar above for future dates.  
 Thursdays, 7:30 PM to 9:30 PM Central Time  
 Brian Schubring's Home  
 2131 Mallard Ln  
 Hanover Park, IL 60133

<https://bluejeans.com/203539242>

Blue Jeans teleconferencing access is available via John Mark Mobley or John Linville. You can also phone in.

**The 29th Annual "Last" Chicago CoCoFEST!**

April 18-19, 2020  
 Holiday Inn Elk Grove Village  
 1000 Busse Road  
 Elk Grove Village, IL 60007  
 Link: <http://glensideccc.com>

**Portland Retro Gaming Expo**  
 October 18-20, 2019  
 Oregon Convention Center  
 Portland, Oregon, USA  
 Link: <http://www.retrogamingexpo.com/>

**Chicago TI International World's Faire**

November 02, 2019  
 Evanston Public Library  
 1702 Orrington Avenue  
 Evanston, IL 60201  
 (847) 448-8600  
 Link: <http://chicagotiug.sdf.org/>

# CoCo Community Corner



A list of CoCo web resources compiled by Steve Strowbridge

Source	Link(s)
Glenside Color Computer Club, host of CoCoFEST!	<a href="#">Website</a>   <a href="#">Classic splash page</a>   <a href="#">Facebook</a>
The TRS-80 Color Computer Facebook Group	<a href="#">Facebook</a>
The Color Computer Mailing List	<a href="#">Website</a>
The TRS-80 MC-10 Facebook Group	<a href="#">Facebook</a>
The CoCo Crew Podcast	<a href="#">Website</a>   <a href="#">Facebook</a>
The Dragon 32/64 Communities	<a href="#">Website</a>   <a href="#">Facebook</a>
CoCoTALK! Weekly live Color Computer talk show	<a href="#">Website</a>   <a href="#">Facebook</a>
Looking for more CoCo Links? Visit I'm a CoCo Nut!	<a href="#">Website</a>

## Close Parenthesis

D. Bruce Moore has kindly allowed CoCo ~123 to publish his new CoCo themed comic. We hope to bring you more installments in future issues.

# JOEY AND COCO

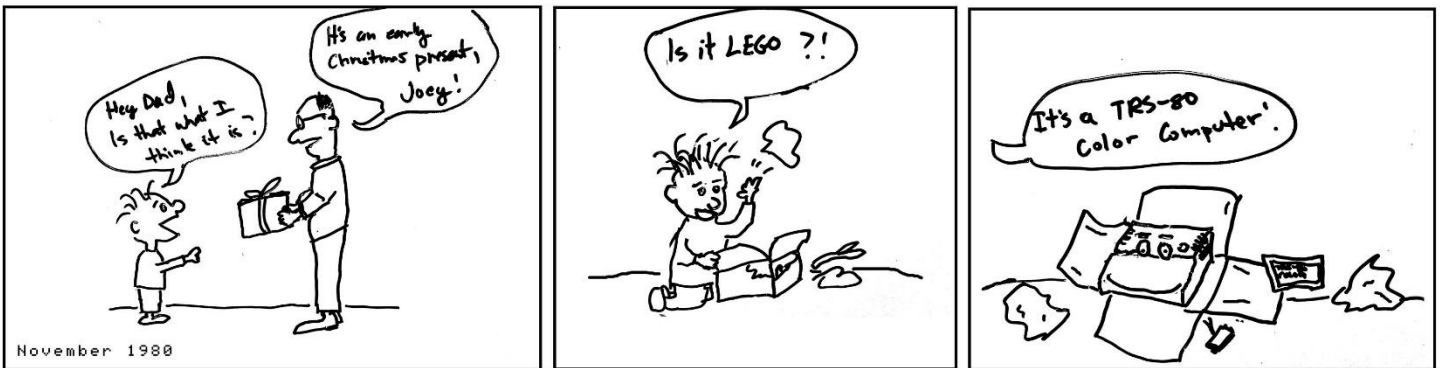

November 1988

(C) 2019 D. BRUCE MOORE

The original CoCo~123 banner:

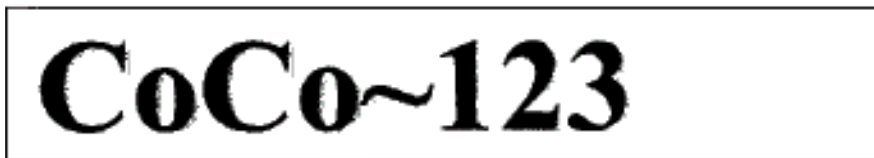

This month, the new newsletter editor made a bold choice to change the title page to a slightly more "colorful" graphic. The original CoCo~123 title image was generated on a CoCo 3 and was produced with a pen plotter. The graphic of the world map has been on display all these years to show off the CoCo's capabilities. What do you think of some of the newsletter changes? Email [ogStevieStrow@gmail.com](mailto:ogStevieStrow@gmail.com) with your feedback.