

80 micro

the magazine for TRS-80* users

AUGUST 1985
USA \$4.00
CANADA \$4.50
A CWC/I PUBLICATION

- Reviewed in This Issue:
- Superlog 4
- GW-Basic Compiler
- 3 Portable Printers
- Monte's Window

MASTERING MODEL 4 BASIC

What Better Way
To Spend
Your Summer?

PATCH WORK REVISITED

13 More Ways
To Upgrade
TRSDOS 1.3

MODEL 4 MAGIC

Run 2 Programs
Simultaneously
With LDOS 5.1

SOFTWARE RIOT!

Our Techies
Pick Their
Dream
Libraries

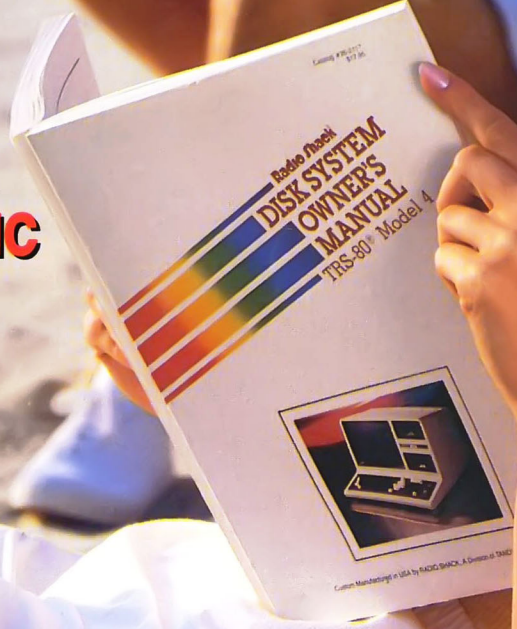

NEW FEATURE:
Dave's MS-DOS Column



WE JUST CUT \$200 OFF OUR MOST POPULAR COMPUTER EVER!

The Tandy 1000 with DeskMate™
software is now only \$999

Monthly Calendar
Highlights Current Date

Function Menu Displays
the Files You Have
Created for Six
Different Applications

Tandy 1000 Is Your Key to Great Software

Whatever your personal applications needs, the Tandy 1000 is for you. Tandy 1000 is compatible with the IBM PC, giving you one of the widest selections of software available today.

And unlike other personal computers, Tandy 1000 even comes with valuable software when you buy it. We call it DeskMate, and it puts your Tandy 1000 to work right away with word processing, spreadsheet analysis, electronic filing, telecommunications, scheduling and electronic mail. DeskMate may be the only program you'll ever need!

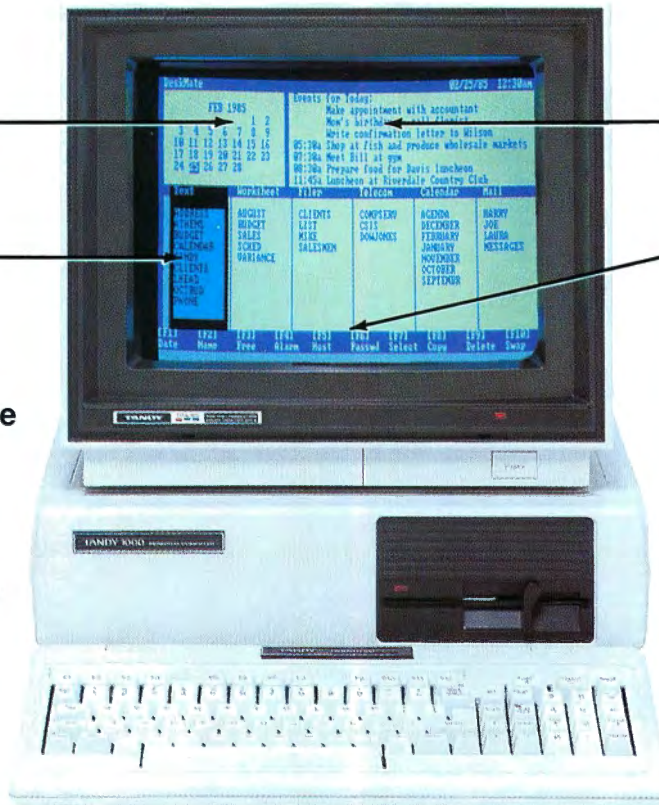

Daily Appointment
Calendar with
Event Reminder

Simple Control-Key
Commands Are Displayed
for Quick and
Easy Reference

You Get So Much More . . . For So Much Less

A Tandy 1000 costs less than IBM's PC, and comes complete with adapters to use a color or monochrome monitor, printer, joysticks and light pen. These adapters, as well as a disk operating system (DOS) and BASIC, are "extras" on the IBM PC!

Best of all, the Tandy 1000 has a new low price—only \$999. (25-1000, Was

\$1199.00 in Cat. RSC-14). Add either a monochrome or color monitor and you're ready for business.

Come in today and get the most computer you can buy for your money.

Available at over 1200
Radio Shack Computer Centers and at
participating Radio Shack stores and dealers.

Radio Shack®
COMPUTER CENTERS

A DIVISION OF TANDY CORPORATION

Circle 75 on Reader Service card.

Monitor sold separately. Prices apply at Radio Shack Computer Centers and at participating stores and dealers. DeskMate/TM Tandy Corporation. IBM/Registered TM International Business Machines Corp.

Did you know?

Only one spelling checker:

- works with both Scripsit and Superscripts.
- integrates with all other popular word processing programs as well.
- requires *no special document placement!* Even runs on a single drive system.
- displays its dictionary so that you can find the correct spelling of words.
- offers integrated Hyphenation Option and Grammar & Style checker.

Electric Webster

SPELLING CHECKER :: AUTO-HYPHENATION :: GRAMMAR CHECKER

Displays Correct Spellings: If you don't know the correct spelling of a word, EW will look it up for you, and display the dictionary.

Verifies Corrections: If you think you know the correct spelling of a word, EW will check it for you before making the corrections.

Hyphenates Automatically: (Optional). Inserts discretionary hyphens throughout text.

Grammar & Style Checker: (Optional). Identifies 22 types of common errors. Makes suggested corrections with the stroke of a key. Runs within EW.

50,000 Word Dictionary: Uses only 2½ bytes per word; add as many words as you wish.

Fast Correcting: In as little as 30 seconds, Electric Webster can return you to your Word Processing program, with your text fully corrected and on your screen.

Integrates: with WordStar, Deskmate, Spellbinder, Volkswriter, Open Access, Allwrite, Newsprint, Lazy Writer, Superscripts, Scripsit, Electric Pencil, Copy Art, Powerscript, Zorlof, and LeScript (specify). Begins proofing at the stroke of a key; returns you to word processing automatically.

When ordering, stipulate word processing program and operating system.

**"The Cadillac"
of spelling checkers**
— 80 *Microcomputing*, 9/82

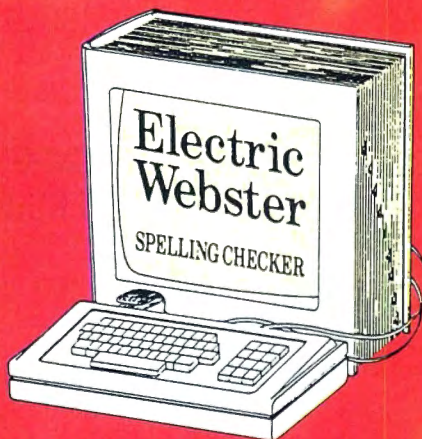

ACCLAIMED:

"Electric Webster is the best. Just read any review in any magazine and I don't believe that you will find even one disagreement to that statement." *CIN-TUG, Cincinnati's Users Group Mag.* 4/83

"The most helpful program I've found is Electric Webster. After looking at nine proofreading programs, I've settled on Webster..." *Creative Computing* 11/83

This dictionary is not published by the original publishers of Webster's Dictionary or their successors.

Performance "Excellent"; Documentation "Good"; Ease of Use "Excellent"; Error Handling "Excellent". *Info World*, 8/82

"Electric Webster, a fantastic spelling and grammar checker" 80 *Micro* 4/85

Now see for yourself!

Try Before You Buy:

For the second straight year, 80 Micro readers have voted Electric Webster the #1 Spelling checker. Find out for yourself how accurate, fast and easy proof-reading can be. For only the \$5 cost of postage, materials and handling, we will send you a special Electric Webster demonstration disk that works just like Webster, but proofs only half the alphabet. With it, you'll get a coupon worth \$5 towards the purchase of Electric Webster.

LOW PRICES:

TRS-80, Model I/III or IV	\$ 89.95
w/Correcting Feature	\$149.95
Hyphenation	\$ 49.95
Grammar & Style Checker	\$ 49.95
CP/M, PC/DOS, Model 1000/2000	
Electric Webster,	
w/Correcting Feature,	\$169.95
Hyphenation, and Grammar	

Circle 45 on Reader Service card.



Cornucopia Software

POST OFFICE BOX 6111, ALBANY, CALIFORNIA 94706, PHONE (415) 524-8098



THE SOURCE OF TRS-80 SOFTWARE!

IF YOU BOUGHT YOUR SOFTWARE ELSEWHERE, YOU PROBABLY PAID TOO MUCH

JMG is one of the largest sources of TRS-80 software around. We specialize in software for Models I, III, and 4. Our prices are the best, and if you find a better price then we'll beat it! (see pricing policy) As well, we support the programs we sell. Our software is only all top-quality, and our 99% satisfaction rate speaks for itself. With the best prices, selection, and support all on your side, you can't lose! Model 4 owners: All Model 3 programs we sell will work on the Mod. 4 in "III mode". Remember that JMG now offers FREE SHIPPING on all orders to the continental U.S. or Canada of over \$25!

HITCHHIKER'S GUIDE TO THE GALAXY

One of the best and newest games from Infocom. A hilarious Science Fiction Adventure game developed from Douglas Adam's best selling novel. Your mission... finding that out is half the fun, as you travel the lengths of the Galaxy, encountering strange and often deadly creatures. This game is a definite must for any avid adventurer, or any eager beginner.

MODEL 3/4 ONLY \$34.50

SUPREME RULER PLUS

The cornerstone of JMG, this game combines strategy with common sense. The goal is to defeat opposing countries while at the same time properly caring for your own country. Battle computer countries, other humans, or combinations of both (up to nine countries total). An entertaining and educational simulation of government policies and their consequences.

MODELS 1/3/4 (disk or cassette) \$26.50

WARRIORS AND WARLOCKS

A role-playing fantasy game based loosely on the hit Dungeons and Dragons. Your long-term objective is develop characters strong enough to survive exploration of the Castle. The full game takes six months to play and provides many rooms and levels. A sure hit with any D & D fanatics.

MODELS 1/3 \$39.50

PRONTO

Specifically designed for the 128K TRS-80 Model 4/4P. Controls variable sizes "windows" (maximum size of a window is screen size, and up to four windows can be opened at one time). Manages applications programs which can be invoked at the touch of a button. Provides a SuperVisor Call facility for assembly language programmers to interface with the window controller. Some window applications included in PRONTO are: Index File, Appointment File, Calendar File, Calculator, Card Filer/Notepad, Character Set, Dialer, Mini-Terminal, and Screen Saver.

Model 4/4P Only (List \$50.00) \$46.50

LE SCRIPT

Our best selling word processor, loaded with many features not found anywhere else. Characteristics of Le Script include great printer support, ease of use, full Model 4 support, and much much more! On a 128K Model 4 you can have over 90K of text buffer for use on a single file (not split) into multiple buffers as is the case in other WP programs). Model 4 features also available while running in the Model 3 mode! The same program will run under most DOSes, from TRSDOS 2.3 on a Model 1 to DOSPLUS IV on a Model 4. At our low price, this is the best word processing value anywhere.

LE SCRIPT Model 1,3,4 (list \$129.95).....\$94.50

WORD PROCESSING PACKAGE DEAL

Buy both LE SCRIPT and ELECTRIC WEBSTER together and save even more! These two programs work great together, so if you're getting into serious word processing, this is the "first class" way to go. This offer is only available for a limited time!

SAVE \$80 OFF THE LIST PRICE!!!

W.P. PACKAGE DEAL.....\$199.50

THE FRENCH CONNECTION

By far the most powerful Bulletin Board System for Models I, III, and 4(III). TFC is written in 100% Z-80 Assembly language for both efficiency and security. Features Upload/Download, open access or private password, layered menus, individual user modifications, and much, much more. (See also separate ad in this publication!)

INTRODUCTORY OFFER (Models 1/3/4) \$99.50

SPECIAL PRICE REDUCTIONS!!! POWERDOT II

"The best high-resolution bit-image graphics program on the market for the TRS-80." Your screen becomes a window on your larger full-page drawing board. AUTODRAW feature for lines and circles. The creation of large graphics is easy. Design and save your own graphic characters as well. Does not need a high-res board to produce high-res graphics. POWERDOT II is 100% Machine Language and supports Epson, ProWriter, Okidata and Radio Shack printers. (Please specify printer when ordering.)

MODELS 1/III/4(III) \$29.50

POWERMAIL PLUS

Extremely advanced, yet simple to use. Mailing List program. Written in Machine Language for the quickest operating speed. Records can easily span multiple drives. Also converts existing file from any other mail systems.

MODELS 1/III/4 \$ 98.50

with Text Merge option \$128.50

SUPERCROSS XT

A program designed specifically for transferring data and program files freely between your own TRS-80 disks and those of many other computers. Eliminates the need for modems, terminal programs or access to a second computer. You can copy programs from 70 different DOS formats directly. Also FORMATS, displays DIRECTORY or KILLS files on alien disks, and can even copy "FOREIGN-TO-FOREIGN" in one step. Copies ASCII, Bit-Image, and Random Files back and forth.

MODELS 1/III/4 \$ 94.50

with Convert Basic Option \$112.50

ELECTRIC WEBSTER

The best word processor for the TRS-80 Computers. Includes a 50,000 word dictionary, and integrates with most word processors. Features fast checking, interactive correcting, and the ability to add your own words to its dictionary. Not much more you can say about this program, just that it does the job and it does it very well. (Get it quick, before the price goes up to \$129.50) Specify computer & word processor when ordering.

ELECTRIC WEBSTER, Model 1,3, or 4 (list \$149.95).....\$119.50

E.W. Grammar of Hyphenation (list \$49.95).....\$38.50

TAS Public Domain Disks

These disks contain a collection of quality public domain programs from all over. There's a wide selection here, from games to utilities to applications, and much more! Each disk is a 40 track "floppy" disk, and both sides are filled to the brim.

PUBLIC DOMAIN DISK PACKAGE, #1 to #4.....\$34.50

PUBLIC DOMAIN DISK PACKAGE, #1 to #6.....\$49.50

PUBLIC DOMAIN DISK (Specify #1 to #6).....each \$9.50

PASCAL-80 (NOW ON SALE!!!)

The easiest version of PASCAL to learn! You get extensions to PASCAL that give you screen control, random access files, calls to machine language, the ability to create turn-key packages, etc. PASCAL-80 is a nearly complete subset of standard PASCAL, including structured types, records, pointers, variables and files. Editor and Compiler are in the memory.

PASCAL-80, Models 1,3 or 4 (list \$79).....SALE PRICE \$59.50



GREAT PROGRAMS, GREAT PRICES AND FREE SHIPPING!!!

This month we have some new items in our line-up, such as the impressive PRONTO windowing systems from Misosys, which includes some very useful built-in applications that can be called up at any time. Also, we have the new BAS GW Convert program for converting IBM programs to Model 4, special formats of the Disk Drive Analyzer program, and new low prices on PowerDot and PowerMail. Plus, of course, our usual collection of top-quality software for the TRS-80 Models I, III and 4.

APPLICATIONS/BUSINESS

PROGRAM	(LISTS)	JMG
Powerdot II	(59.50)	\$ 29.50
Datagraph	(79.95)	\$ 69.50
Mumford's Disk Indexer	(39.95)	\$ 34.50
Howe's System Diagnostic	(99.95)	\$ 89.50
J & M's Disk Drive Analyzer - I	(89.00)	\$ 84.50
J & M's Disk Drive Analyzer - III	(79.00)	\$ 74.50
ENBASE Data Base Manager	(140.00)	\$129.50
POWERMAIL PLUS	(150.00)	\$ 98.50
POWERMAIL PLUS w/Txt Merge	(175.00)	\$128.50
TAS's ZMAIL Mail List	(29.95)	\$ 24.50
LESCRIPT	(129.95)	\$ 94.50
LESCRIPT CP/M	(199.95)	\$149.50
ZORLOF II	(69.95)	\$ 49.50
LAZYWRITER	(125.00)	\$ 99.50
TYPEITALL	(129.95)	\$ 99.50
PowerScript (New Version)	(39.95)	\$ 34.50
ELECTRIC PENCIL	(89.00)	\$ 79.50
TEXTPRESS	(49.95)	\$ 39.50
ELECTRIC WEBSTER	(149.95)	\$119.50
E.W. Options (each)	(49.95)	\$ 38.50
EDIT Mod I/III	(40.00)	\$ 36.50
Home Accountant	(79.95)	\$ 59.50
VersaLedger II	(149.95)	\$134.50
Versa Series (each)	(99.95)	\$ 89.50
DOSPLUS 3.5 Mod I/III	(69.95)	\$ 59.50
DOSPLUS IVA for Model 4	(169.95)	\$119.50

UTILITIES

Alcor C Compiler	(list 250.00)	\$ 84.50
Alcor Multi-Basic Compiler	(list 250.00)	\$ 84.50
TFC BBS		\$ 99.50
Super Utility 4/4P		\$ 69.50
Super Utility 3.2		\$ 59.50
Supercross XT		\$ 94.50
Supercross XT w/CnvBasic		\$112.50
Edas / PRO-CREATE		\$ 69.50
ALE - Assembly Language Editor		\$ 39.50
M-ZAL Macro Assembler		\$ 79.50
Mumford's Instant Assembler		\$ 44.50
Instant Assembler Model 4		\$ 59.50
ZEN Assembler		\$ 34.50
DSMBLR III / PRO-DUCE		\$ 23.50
DIS' n' DATA I/III		\$ 37.50
DIS' n' DATA Model 4		\$ 46.50
TASMON Monitor I/III or 4		\$ 34.50
Howe's Monitor #5		\$ 19.50
LC / PRO-LC Compiler		\$114.50
PASCAL 90 Compiler		\$ 59.50
PASCAL 80 for CP/M		\$ 36.50
SBE Compiler		\$ 94.50
ACCEL 3/4 Compiler		\$ 89.50
ZBASIC Compiler		\$ 79.50
CNVBASIC Model I/III/4		\$ 27.50
Model 4 TOOLBELT		\$ 39.50
PRO-ESP Utility Set (Model 4)		\$ 23.50
6.2 Plus Enhancements		\$ 36.50
Lazycomm Terminal		\$ 29.50
Disk Term Terminal		\$ 59.50
MULTIDOS Version 1.7		\$ 79.50
MULTIDOS Model 4		\$ 89.50

GAMES

SUPREME RULER PLUS	\$26.50
FLIGHT SIMULATOR	\$29.50
NUCLIX	\$14.50
APE	\$14.50
SIFTER SHIFTER	\$ 8.50
BATTLE OF ZEIGHTY	\$ 8.50
FOREST FIRE DISPATCH	\$26.50

INFOCOM

"Standard Level"	Each \$34.50
PLANETFALL	WITNESS	CUTTHROATS
ENCHANTER	HITCHHIKER'S	
"Intermediate Level"	Each \$39.50
ZORK II	ZORK III	
SORCERER	INFIDEL	
"Very Difficult Level"	Each \$42.50
DEADLINE	STARCROSS	

OTHER GOODIES:

BOOKS:	
ROM ROUTINES Documented	\$16.50
Model III Assembly Language	\$15.50
Microsoft Basic Decoded	\$23.50
TRSDOS 2.3 Decoded	\$23.50
BASIC Faster & Better	\$23.50
BFBLIB or BFBDEM Disks	each \$16.50
BASIC Disk I/O F & B	\$23.50
DFBLOAD disk	\$16.50
DISKS: On a trial basis we are offering Wabash "Datatech" blank diskettes for sale. Lifetime guarantee, in soft box with labels etc. These are Single Side Double Density (other formats available).	
SDDD Wabash (10 pack)	\$15.00

ORDERS & INFORMATION: (416) 575-2867

Use this number for ordering and for technical information. Phones are usually staffed Monday to Saturday, 10 A.M. to 7 P.M.

MONTHLY SPOTLIGHT

KSoft's LOG and SUPERLOG

Versatile "Electronic Notebook" that allows you to access stored information at the touch of a key, keeps notes, memoes, lists, or other information in instantly accessible "pages". SUPERLOG4 for the Model 4 also contains many advanced features and commands that will make you wonder how you ever lived without it.

LOG for Model I or III	\$44.50
SUPERLOG for Mod I or III LDOS	\$99.50
SUPERLOG4 for Model 4 (List \$119.95)	\$99.50

CONVERSION CORNER

BASIC 3 TO 4 CONVERT

Operates under Model 4 TRSDOS 6.x, CP/M, MSDOS (general), and MSDOS (2000). Converts Model III programs to run under these systems, inserts spaces and translates commands where necessary. Please specify which version you want.

Basic 3 To 4 Convert (list \$49.95)	\$39.50
-------------------------------------	-------	---------

BASIC 4 TO 3 CONVERT

Operates on Model I & III DOSes. Converts programs from Mode 4 Basic. Similar to Basic 3 To 4.

Basic 4 To 3 Convert (list \$49.95)	\$39.50
-------------------------------------	-------	---------

BASIC GW CONVERT

A collection of programs and subroutines designed to translate IBM BASIC programs for use on TRS-80 Model 4! Will even convert high-res graphics if you have a high-res graphics board.

MODEL 4/4P ONLY (list \$99.95)	\$89.50
--------------------------------	-------	---------

OUR PRICING POLICY:

We will beat any legitimate price advertised for any product that we carry. If you find a lower price advertised, our price will be \$1.00 less, under the same conditions (eg. same shipping and other charges, etc). To receive the lower price you must mention the location of the other ad when ordering.

TO ORDER:

We accept orders by phone or mail. When ordering please specify the Model of TRS-80 that you own, the exact program(s) wanted, and the method of payment. We accept Check, Money Order, VISA, MasterCard. (For Electric Webster please mention your word processor.) All prices are listed in U.S. Funds.

OUR GUARANTEE:

We sell only top-quality software. If, however, you are unsatisfied with a product you have purchased from JMG, you may return it (in good condition) within 10 days for a refund, less a \$2.50 handling charge for programs under \$50 (\$5.00 for programs over \$50). We also ask that you send us a letter stating the reason for your return.



THE FINE PRINT:

Regular shipping in continental US and Canada is FREE (our choice of method). COD orders add \$2.50 to cover COD costs. PO's accepted for gov't & schools, add \$5.00 handling charge. Overseas orders will be charged actual shipping costs; specify surface or air. All prices subject to change without notice.

3235 LOCKPORT ROAD
NIAGARA FALLS, NY 14305

OR

710 UPPER JAMES ST.
HAMILTON, ONTARIO
CANADA L9C 2Z8

Phone: (416) 575-2867

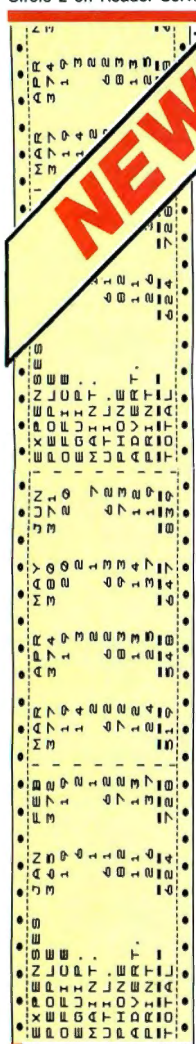

IS YOUR PRINTER TOO SHORT FOR YOUR SPREADSHEET?

LONGVIEW turns a VisiCalc (R) spreadsheet on its side so that DOTWRITER can print it down the paper instead of across. It gives you the effect of a 400-character wide printer (or even longer, if your spreadsheet is that big).

The number of "rows" becomes the limit when you print this way: you can fit between 48 (Microline 92) and 180 (C.I.TOH 1550) rows across the page.

LONGVIEW is an "add-on" to our Dotwriter system. It includes programs and three character sizes, and runs on 48K-64K TRS-80 Models I, III, and 4/4P (native Model 4 mode). Please see our ad later in this magazine for information and pricing on Dotwriter, and the printers we support.

LONGVIEW is easy to use and comes with ready-to-run setups. First, tell VisiCalc to print your spreadsheet to disk. Next, rotate the file with LONGVIEW. Then, print it with Dotwriter. That's all there is to it.

LONGVIEW . . . \$29.95
(does not include Dotwriter or VisiCalc)

DOWNLOADABLE FONTS \$59.95

We have dozens of high-resolution, downloadable fonts for the Radio Shack DMP 2100P and the Epson LQ-1500. They include italics, cursive, headline, and other fancy typefaces. Each font disk includes programs to perform the download, and sample files to print them for you.

The print quality of these fonts must be seen to be believed. ALLWRITE can load these fonts "on the fly" and give you right-justified, proportional printing. If you do not have ALLWRITE, you can pre-load a font and use it with any software, including BASIC (right-justification is only possible with ALLWRITE, however).

Each disk contains at least eleven fonts and supporting programs. The disks cost \$59.95 each, and we

offer substantial discounts to ALLWRITE owners. Please call or write to us for print samples, further information and pricing. Due to the specialized nature of this product, we recommend that you see the samples before ordering. Disk formats are available for TRS-80 I, III, 4, and MS-DOS. ALLWRITE is available only for TRS-80.

Information on these products is not available at our toll-free answering service, so please call or write to our Technical Support group for details:

(818) 764-3131

PROSOFT

Box 560, No. Hollywood, CA 91603

Please add \$3.00 for shipping. Calif. residents add sales tax. We accept M/C, VISA, checks and C.O.D.

PUBLISHER
Peter Hutchinson

EDITOR-IN-CHIEF
Eric Maloney

MANAGING EDITOR
Peter E. McKie

SENIOR EDITOR
Penelope Hamblin

REVIEW EDITOR
Ryan Davis-Wright

TECHNICAL EDITORS
Bradford N. Dixon
Mare-Anne Jarvela
Keith Johnson (Load 80)

Dave Rowell
Beverly Woodbury

PROOFREADER
Vinoy Laughner

EDITORIAL ADMINISTRATION
Carole Maciocci
Kelly DeKoning

ASSOCIATE EDITORS

Hardin Brothers
David Engelhardt

John B. Harrell III

Terry Kepner

Thomas L. Quindry

ADVERTISING SALES

SALES MANAGER
William Smith

SALES REPRESENTATIVES

Michael Wozmak
1-800-441-4403

WEST COAST OFFICE

1060 Marsh Road
Menlo Park, CA 94025
415-328-3470

SALES REPRESENTATIVE
Alisson Walsh

ADVERTISING COORDINATOR
Judy Walker

ADVERTISING SECRETARY
Cathy Berry

MARKETING/PROMOTION DIRECTOR
Jane Butterfield



The left bracket, [, replaces the up arrow used by Radio Shack to indicate exponentiation on our printouts. When entering programs published in 80 Micro, you should make this change.

80 formats its program listings to run 64-characters wide, the way they look on your video screen. This accounts for the occasional wrap-around you will notice in our program listings. Don't let it throw you, particularly when entering assembly listings.

Article submissions from our readers are welcomed and encouraged. Inquiries should be addressed to: Submissions Editor, 80 Pine Street, Peterborough, NH 03458. Include an SASE for a copy of "How to Write for 80 Micro." Payment for accepted articles is made at a rate of approximately \$50 per printed page; all rights are purchased.

*TRS-80, Scripsit, and TRSDOS are trademarks of Radio Shack, a division of Tandy Corp.

80 Micro (ISSN-0744-7868) is published monthly by CW Communications/Peterborough Inc., 80 Pine St., Peterborough, NH, 03458. Phone: 603-924-9471. Second class postage paid at Peterborough, NH, and additional mailing offices. (Canadian second class mail registration number 9563.) Subscription rates in U.S. are \$24.97 for one year, \$38 for two years, and \$53 for three years. In Canada and Mexico \$27.97—one year only, U.S. funds drawn on a U.S. bank. Nationally distributed by International Circulation Distributors. Foreign subscriptions (surface mail), \$44.97—one year only, U.S. funds drawn on a U.S. bank. Foreign subscriptions (air mail) please inquire. In South Africa contact 80 Micro P.O. Box 782815, Sandton, South Africa 2146. All subscription correspondence should be addressed to 80 Micro, Subscription Department, P.O. Box 981, Farmingdale, NY 11737. Please include your address label with any correspondence. Postmaster: Send address changes to 80 Micro, Subscription Services, P.O. Box 981, Farmingdale, NY 11737. Send Canadian changes of address to 80 Micro, P.O. Box 1051, Fort Erie, Ontario L2A 5N8, Canada. Return postage guaranteed.

Entire contents ©copyright 1985 by CW Communications/Peterborough Inc. No part of this publication may be reprinted, or reproduced by any means, without prior written permission from the publisher. All programs are published for personal use only. All rights reserved.

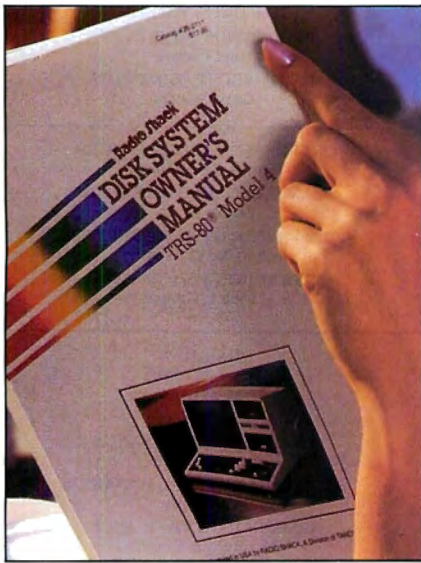

page 38



page 46



page 56

On the Cover

- 38. **Summer Romance**
by Clifford I. Knight
Get involved with Model 4 Basic. (Model 4; Load 80)
- 56. **Duelling Software**
by Bradford N. Dixon and Dave Rowell
The authors test their software savvy in a \$4,000 spending duel.
- 62. **The Great Divide**
by E. Cameron Snyder
Swap back and forth between two programs running simultaneously on your 128K Model 4. (Model 4; Load 80)
- 72. **Patch Work II: The Sequel**
by Andy Levinson
Just when you thought it was safe to boot up TRSDOS 1.3, Andy Levinson's back with a new batch of improvements. (Model III; Load 80)
- 90. **Dave's MS-DOS Column**
by Dave Rowell
Special introductory offer: a printer fix, no-frills machine language, and music.

Features

- 46. **Sifting Through GW-Basic**
by Dave Rowell
Grains of truth about Basic programming on the Tandy 1000.
- 76. **Upgraded Graphics**
by Alan D. Smith
Model 4 Point, Set, and Reset commands—together again for the first time. (Model 4; Load 80)

Departments

- | | |
|---|--|
| 6. Load 80 Directory | 90. Dave's MS-DOS Column |
| 8. Side Tracks
<i>by Eric Maloney</i> | <i>by Dave Rowell</i> |
| 12. Input | 94. Basic Takes
<i>by Richard Ramella</i> |
| 14. Feedback Loop
<i>by Terry Kepner</i> | 98. The Next Step
<i>by Hardin Brothers</i> |
| 21. Pulse Train
<i>by Bradford N. Dixon</i> | 108. Spreadsheet Beat
<i>by L.H. Southmayd</i> |
| 25. Reader Exchange | 112. Tidbit #26 |
| 29. Reviews
Superlog 4
MS-GW-Basic Compiler
ThinPrint 80, Hush 80,
ThinType 80
Monte's Window
The Math Master Series | 114. Express Checkouts
Pro-Create 4.3
Microsoft Word 2.0
The Norton Utilities 3.0
Mod-4 by Jack |
| 80. Project 80
<i>by Roger C. Alford</i> | 118. New Products |
| | 125. MS-DOS New Products |
| | 128. Ask Tandy |

LOAD 80

Load 80 gathers together selected programs from this issue of *80 Micro* and puts them on a magnetic medium for your convenience. It is available on tape or disk, and runs on the Models, I, III, and 4.

Load 80 programs are ready to run, and can save you hours of time typing in and debugging listings. Load 80 also gives you access to Assembly-language programs if you don't have an editor/assembler. And, it helps you build a substantial software library.

Using Load 80 is simple. If you own a tape system, load the Load 80 tape as per the instructions provided. If you own a Model I or III disk system, you boot the

Load 80 disk and transfer the files to a TRSDOS system disk according to simple on-screen directions. If you own a Model 4, copy the Model 4 programs from the Load 80 disk to your TRSDOS 6.X disk using the COPY command.

Not all programs will run on your system. Some Model III programs, for instance, will run on the Model 4 in the Model III mode, but not in the Model 4 mode. You should check the system requirements box that accompanies the article to find out what system configuration individual programs require.

If you have any questions about the programs, call Keith Johnson at 603-924-9471. Yearly subscriptions to Load 80 are \$199.97 for disk, or \$99.97 for cassette. Individual loaders are available on disk for \$21.47 or on cassette for \$11.47, including postage. To place a subscription order, or to ask questions about your subscription, please call us toll free at 1-800-343-0728 between 9 a.m. and 5 p.m. Or, you can write to Load 80, 80 Pine St., Peterborough, NH 03458.

Directory

Menu, Clock

Article: Summer Romance (p. 38).
System: Model 4, 64K RAM.

Menu sequencing and clock display routines.

Language: Disk Basic.

Cassette filespecs: B, C.

Disk filespecs: MAINMENU/BAS, CLOCK/BAS.

Times2

Article: The Great Divide (p.62).
System: Model 4/4P, 128K RAM, LDOS 5.1, EDAS editor/assembler.

Run two programs simultaneously and swap back and forth between them.

Language: Assembly.

Cassette filespec: TIMES2/CMD (object code).

Disk filespecs: TIMES2/SRC (source code), TIMES2/CMD (object code).

Patch

Article: Patch Work II: The Sequel (p. 72).

System: Model III, 32K RAM, TRSDOS 1.3.

This Basic program creates a JCL file that installs up to 13 TRSDOS 1.3 patches.

Language: Disk Basic.

Cassette filespec: D.

Disk filespec: DOMAKER/BAS.

Pixel

Article: Upgraded Graphics (p. 76).

System: Model 4, 64K RAM.

Add the graphics commands Point, Set, and Reset to Model 4 Basic. Includes a demonstration program.

Language: Disk Basic.

Cassette filespecs: E, F.

Disk filespecs: PIXEL/BAS, PXLDEMO/BAS.

Window

Article: The Next Step (p. 98).

System: Model 4/4P, 128K RAM, ALDS editor/assembler.

Window system user interface; third in a three-part series.

Language: Assembly.

Cassette filespec: WU (object code).

Disk filespecs: WU/SRC (source code), WU/FLT (object code).

Bond

Article: Spreadsheet Beat (p. 108).

System: Model III, 48K RAM, VisiCalc.

Calculate bond yield to maturity for regular and zero-coupon bonds.

Disk filespec: BONDYTM/VC.

ART DIRECTOR
Beth Krommes
PRODUCTION SUPERVISOR
Dion Owens/Kanner
PRODUCTION ASSISTANT
Janet Brown
AD/GRAPHICS PRODUCTION
Gary Ciocci

GRAPHIC SERVICES MANAGER
Dennis Christensen
MANUFACTURING MANAGER
Susan Gross
FILM PREPARATION SUPERVISOR
Robert M. Villeneuve
TYPESETTING SUPERVISOR
Linda P. Canale

CHAIRMAN
James S. Povec
PRESIDENT
Debra Wetherbee
VICE PRESIDENT/FINANCE
Roger Murphy
ASSISTANT GENERAL MANAGER
Matt Smith
ASSISTANT TO VP/FINANCE
Dominique Smith
DIRECTOR OF CIRCULATION
William P. Howard
CIRCULATION MANAGER
Frank Smith
DIRECT AND NEWSSTAND SALES MANAGER
Raimo Wirein
1-800-343-0728
DIRECTOR OF CREDIT SALES
AND COLLECTION
William M. Boyer
EXECUTIVE CREATIVE DIRECTOR
Christine Destrempe

FOUNDER
Wayne Green

Cover photograph by White/Packert Photography

80 Micro is a member of the CW Communications/Inc. group, the world's largest publisher of computer-related information. The group publishes 57 computer publications in 20 major countries. Nine million people read one or more of the group's publications each month. Members of the group include: Argentina's *Computerworld/Argentina*; Asia's *The Asian Computerworld*; Australia's *Computerworld Australia*, *Australian PC World*, *Macworld* and *Directories*; Brazil's *DataNews* and *MicroMundo*; China's *China Computerworld*; Denmark's *Computerworld/Danmark*, *PC World* and *Run/Commodore*; Finland's *Mikro*; France's *Le Monde Informatique*, *Golden (Apple)* and *OPC (IBM)*; and *Distributique*; Germany's *Computerwoche*, *Microcomputerwelt*, *PC Welt*, *SoftwareMarkt*, *CW Edition/Seminar*, *Computer Business*, *Run* and *Apple's*; Italy's *Computerworld Italia*; and *PC Magazine*; Japan's *Computerworld Japan*; Mexico's *Computerworld/Mexico* and *CompuMundo*; The Netherlands' *Computerworld Benelux* and *PC World Benelux*; Norway's *Computerworld Norge*, *PC WORLD* and *Run (Commodore)*; Saudi Arabia's *Saudi Computerworld*; Spain's *Computerworld/Espana*, *Microsistemas/PC World*, *Commodore World*; Sweden's *ComputerSweden*, *Mikrodatorn*, and *Svenska PC*; the UK's *Computer Management*; *Computer News*, *PC Business World*, and *Computer Business Europe*; Venezuela's *Computerworld Venezuela*; the U.S.' *Computerworld*, *HOT CoCo*, *inCider*, *InfoWorld*, *MacWorld*, *Micro Market-world*, *PC World*, *Run*, *73 Magazine*, *Focus Publications*, *On Communications*, and *80 Micro*.

Problems with Subscriptions: Send a description of the problem and your current and/or most recent address to: *80 Micro*, Subscription Department, P.O. Box 981, Farmingdale, NY 11737.

Problems with Load 80 Circulation: Address correspondence to Load 80, 80 Pine St., Peterborough, NH 03458.

Problems with Advertisers: Send a description of the problem and your current address to: *80 Micro*, Rt. 101 & Elm Street, Peterborough, NH 03458, ATTN: Rita B. Rivard, Customer Service Manager. If urgent, call 1-800-441-4403.

Change of Address: Send old label or copy of old address and new address to: *80 Micro*, P.O. Box 981, Farmingdale, NY 11737. Please give eight weeks advance notice.

Microfilm: This publication is available in microform from University Microfilms International, United States address: 300 North Zeeb Road, Dept. P.R., Ann Arbor, MI 48106. Foreign address: 18 Bedford Row, Dept. P.R., London, WC1R4EJ, England.

Dealers: Contact Raimo Wirein, Retail Sales Manager, *80 Micro*, Pine St., Peterborough, NH 03458. (800) 343-0728.

NEW! TANDY 1000 HD WITH TEN MEGABYTES... FOR ONLY \$1999!

A hard disk business computer for the same price as an IBM PC without a hard disk.



Tandy . . . Clearly Superior™

Now you can get a high-capacity business computer at a lower price than you ever dreamed. The new Tandy 1000 HD (25-1001) comes with a built-in ten-megabyte hard disk drive. That's 10 million characters of fast-access storage for large data base processing, inventory control, accounting and payroll—any of the big jobs!

Best of all, the Tandy 1000 HD is only \$1999. An IBM PC *without* a hard disk is \$1999*. And with a PC, you

still have to pay for all the "extra" adapters that come standard on the Tandy 1000. Pick the 1000 HD and you've got a superior system—for much less than you'd pay for a comparable IBM PC system. Plus, you also get multi-function DeskMate™ software at no additional charge!

Stop by your local Radio Shack Computer Center today and see the Tandy 1000 HD, as well as the

original Tandy 1000 (25-1000), now at the new low price of \$999. That's \$200 less than last year's price. Step up to the best for less. Tandy is Clearly Superior!

Available at over 1200
Radio Shack Computer Centers and at
participating Radio Shack stores and dealers.

Radio Shack®
COMPUTER CENTERS
A DIVISION OF TANDY CORPORATION

Circle 75 on Reader Service card.

Send me a
1985 computer
catalog.

Name _____
Company _____
Address _____
City _____
State _____ Zip _____
Telephone _____

Mail To: Radio Shack
Dept. 86-A-171
300 One Tandy Center
Fort Worth, Texas 76102

*Based on manufacturer's suggested retail price as of 4/1/85. Monitor sold separately. Tandy 1000 and 1000 HD prices apply at Radio Shack Computer Centers and at participating stores and dealers. IBM/Registered TM International Business Machines Corp.

Word Processors Don't Improve Writing

If you read the IBM PC magazines, you might have seen the Leading Edge Word Processor ad that features a picture of Abraham Lincoln and the opening lines to the Gettysburg Address. The point of the ad is never entirely clear, but along the way Leading Edge marvels at how "the great ones" were able to "record huge hunks of Truth" with nothing more than "primitive" scraps of paper.

"The amazing thing is that these monumental processors of words, did it without the benefit of monumental help," Leading Edge says with open-eyed wonder. That "monumental help" turns out to be (surprise!) Leading Edge's word processor.

Never mind that the ad includes several examples of incorrect punctuation, including the renegade comma in the sentence quoted above. You don't have to worry about such trifles when you're talking about huge hunks of Truth. I'm not as bothered by the sloppy writing as I am by the sloppy thinking, the notion that word processors somehow liberate creativity that heretofore could only be sucked laboriously from the well of imagination with a rusty old hand pump.

Personally, I don't find comfort in the thought of Lincoln using a word processor. I have an image of Abe on the eve of his Gettysburg appearance discussing matters with an aide:

Aide: Is your address done yet, sir?

Lincoln: Nah. I'll just bang it out on my 100 on the way there, and read it from the LCD.

Aide: But sir, we were hoping we could merge the file with our mailing list, and send out personalized copies to the press.

Once Lincoln did generate (as opposed to "write") the speech, he probably would have edited it to read something like "Eighty-seven years ago, our ancestors started this nation with the idea that everybody should be free and that we're all the same." How could he resist all those advanced editing capabilities?

The Leading Edge ad perpetuates the myth that word processors improve writing. Buy this software and you, too, can express yourself as Abe did. Well, that's not true. Good writing comes from the marriage of insight and articulation;

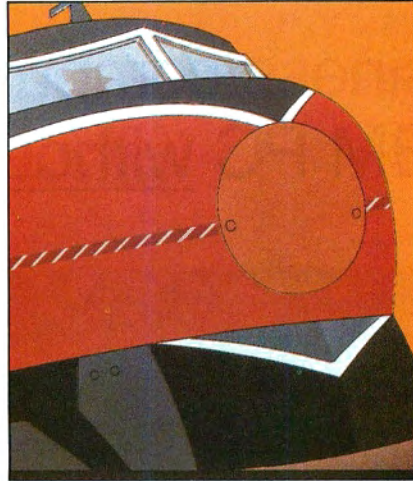

it's the ability to see the world with new eyes and share your vision with others. A word processor will not help. If you have nothing to say, all the software will do is let you say it with justified type and automatic footers.

In fact, I'll go one step further: Word processors can in some cases be counterproductive. They can break down healthy patterns, encourage sloppiness and lassitude, and turn the rough, unpredictable landscape of the mind into a suburb of seamless lawns and climate-controlled shopping malls.

I want to emphasize "in some cases." I won't argue that word processors are terrific for journalists, hack writers, white-collar workers, and secretaries, for whom time and volume is important.

I speak more for the craftspeople who recognize that while content precedes form, form can give shape, color, and texture to content, much as a climate stamps those who live in it.

This is why many writers are almost obsessive about the tools with which they work. The wrong size paper, a pen that feels funny, a different chair—they can stop a writer dead in his tracks.

I've noticed a change in my own writing over the last several years. Once upon a time, when all I used was a typewriter or notebook, I would spend days writing a piece in my head before I committed it to paper. When I finally sat down at my desk, I knew exactly what I wanted to say and how I wanted to say

it. The result was usually quick, simple prose set down in a single draft.

As I've come to use a word processor almost exclusively, the discipline of that pattern has slowly dissipated. I find myself approaching a writing task with hardly an idea of what I'm going to say, and not much concern about it. Why should I worry? If I don't like how these little pixels are arranged, I can just turn them off and light up another string, until I find a combination that suits me.

The result is often a partly conceived or vaguely expressed idea, an idea that I might have discarded if I'd first exercised it in my mind.

As I struggle to figure out what I'm going to say, I end up with a lot of time on my hands, time that invites excessive dawdling. So I occupy myself with the trivial tasks of writing—correcting typos, replacing words with ones that seem just a little bit better, inserting paragraph marks, and the like. I can make believe I'm working when in fact I've shut my brain off, like a would-be musician who spends all his time tuning his guitar instead of playing it.

Lingering over your writing has another unhealthy side effect—it encourages excessive polishing. I can spend so much time looking for the perfect word, the perfect phrasing, the perfect cadence that I drain the life from my prose; it's as smooth and hard as ice, but also as cold.

So what am I going to do about it? Alas, like so many others, I'm hooked on word processors like I'm hooked on electric lights and a car (I haven't surrendered my wood stove yet). I know the spiritual benefits of living closer to the primal technologies that nature bequeaths us, but am seduced by the material gains granted by the grosser technologies of modern life.

I have pledged, however, to return my Hermes 3000 manual typewriter to my desk at home. By day, I'll be a high-tech word-cruncher; by night, a sensualist indulging in the rich pleasures of the language. I'll do so having learned this lesson: No matter how efficient and productive a word processor can be, it will never inspire a thought, or capture a feeling, or express an idea. I'll have to handle those jobs myself. ■

NEW!

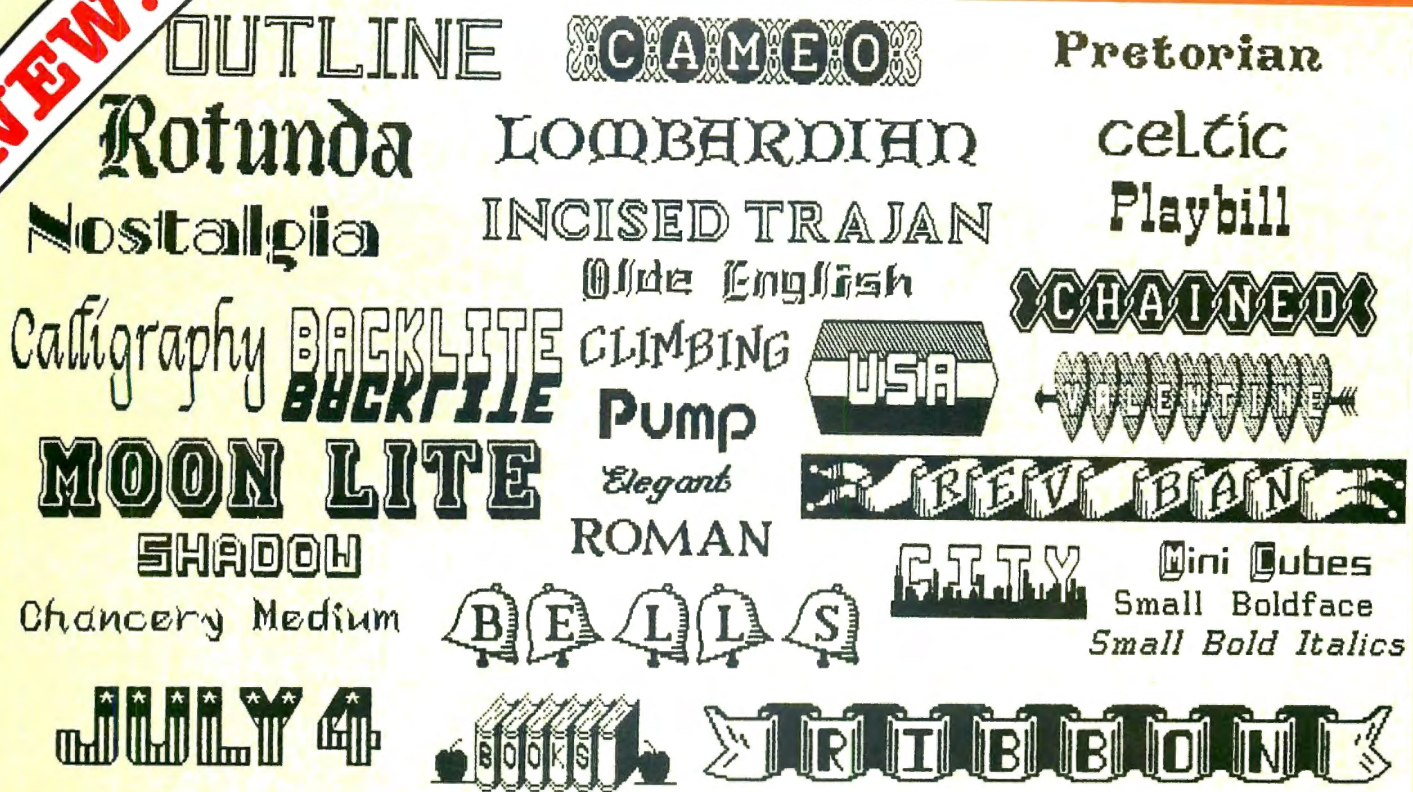

Circle 91 on Reader Service card.

These were printed by DOTWRITER on an Epson MX-80.

See What You Can Do With DOTWRITER 4.0!

Now available for the Model 4, too!



DOTWRITER lets you create spectacular, eye-catching letterheads, catalogs, invitations, or even books. It is just what you need to turn your dot-matrix printer into a versatile typesetting machine. And it's available for the Model 4 (yes, in native mode) as well as for the Models I and III.

What is DOTWRITER?

DOTWRITER uses the "bit-image graphics" of your printer to produce the kinds of stunning results shown inside the box. It is a full-function text printing program, so you can inter-mix different character sets, do centering, paragraphs, pagination, magnification, draw horizontal and vertical lines, reversals (white on black), and even print right-justified proportional text.

DOTWRITER includes the printing program, complete documentation, and fourteen useful sets of typefaces (60 to 90 characters in each set). We will include the 160 page Letterset Reference Summary at half-price (\$10.00) with your order.

To use DOTWRITER, just write your text with any popular TRS-80 Word Processor, add the necessary format-

ting commands, and DOTWRITER will do the rest.

35 more disks are available separately. Each has 3-12 complete typefaces (60-95 characters in each set).

These disks cost less than \$25 each, and may be purchased at any time.

If you want to create your own logos, modify our typefaces, or even design entirely new typefaces, then you will also want to order the "Letterset Design System" (LDS). We offer LDS at half-price when you order it along with DOTWRITER. LDS operates in Model III mode on the Model 4.

Versions are available for Epson MX-80 with Graftrax, MX-100 with Graftrax-Plus, RX-80, FX-80, C. ITOH 8510/1550, Microline 84/92/93; Radio Shack's DMP series 200-2100, CGP-220 & Gemini 10X, 15X. Please specify printer and computer!

Our print samples were done on an Epson. Sizes vary on other printers. Some of the samples shown here are taken from the additional Letterset disks.

Two disk drives and at least 48K of memory are required. LDS is not available in native Model 4 mode.



Send for free print samples! We've only shown you a few of the 230 DOTWRITER fonts. If you want the best in graphics printing, we suggest you order DOTWRITER today, toll-free.

Please specify printer and computer when ordering.

DOTWRITER (Models I, III)	\$79.95
DOTWRITER (Model 4)	99.95
Letterset Design System	39.95
Special: DOTWRITER and LDS	99.95
Additional Letterset disks (4-12 per disk)	24.95
Letterset Reference Summary	20.00

ORDER NOW, TOLL-FREE (800) 824-7888, oper. 422

PROSOFT

Dept. C, Box 560, No. Hollywood, CA 91603
(818) 764-3131 Information and Same-Day Processing

TERMS: VISA, MC, checks, COD. Please add \$3.00 shipping in U.S. or Canada, \$15.00 overseas, sales tax in Ca. Most orders filled within one day.

and then show you where the lost text belongs. This advanced error recovery turns a disaster into a feeling of profound relief.

User-Definable Soft Keys Reduce Typing Time

You can store 22 phrases or commands at a time into "soft-keys," then press just two keys to retrieve them. This makes frequently-used phrases and formatting controls a snap to use. You can store these definitions on disk and build a library of hundreds of pre-programmed keys to fit every one of your applications.

Our specially-designed templates fit right on your keyboard to let you see your settings at all times. Each template is also a Reference ("Cue") Card, so it is always right in front of you when you need it, without using up valuable screen space.

ALLWRITE Is Easy To Learn

ALLWRITE's commands and control keys are easy to remember because they use the first letters of common English words: 'CE' stands for 'Center,' 'Search' and 'Replace' do just that, and so forth. The on-line HELP menu offers over fifty screens of topics.

NEWSSCRIPT's documentation was acclaimed in every review, and ALLWRITE's 350-page book is even better. Portions of it are designed for beginners, with every feature clearly explained in step-by-step tutorial style. Since you won't always be a beginner, other parts of the book offer advanced topics. There is a cross-reference summary chapter, a 14-page comprehensive index, and a detailed Table of Contents. We've been developing computer programs and manuals for over 20 years, and understand the importance of good documentation.

To make installation easy, we include Tiny DOSPLUS for the Models I and III, and special, pre-tailored versions of both TRSDOS 6.2 and DOSPLUS IV for the Model 4, all at no extra charge. The Model I and III versions work equally well with all major DOS's.

PROSOFT'S On-Going Customer Support

Perhaps the best reason of all for having ALLWRITE is the continuing support we offer you: friendly, expert, direct support that is unsurpassed in the micro-computer industry. There is no time limit to our support: if you are our customer and you need help, just call or write. We give free updates for 90 days, and charge little or nothing for minor updates thereafter.

Customer Comments

"This is the best software package I have ever received...superb, easy to use, fast, and has more features than the business word-processor at the office." (E.R.L.)

"ALLWRITE is a professional system that sets a new standard in word processing. It's powerful and easy to learn and use."

80 MICRO, Nov., 1984

"Your company and products have to be one of the strongest factors I can think of for keeping me with the TRS-80!" (J.R.H.)

"NEWSSCRIPT is the Cadillac of word processors. ALLWRITE is the Mercedes Benz!" (B.E.)

"...a very readable manual." (D.S.)

BENEFITS OF OWNING

★ ★ ALLWRITE ★ ★

If Word Processing is important to you, PROSOFT's ALLWRITE is the best choice you can make. The clean, professional appearance it adds to your letters and reports will make an excellent impression on people. We will be happy to send you free print samples so that you can see for yourself how good ALLWRITE will make you look.

You probably know that quality word processors for CP/M and the IBM-PC sell for \$300-500, and they don't have ALLWRITE's capabilities or speed...or PROSOFT's proven, on-going support. Now, for a fraction of the cost of a new computer, you can have the most complete word processor of all. And you won't have the headaches of starting all over again with a new, different computer.

Note to college students: with its Footnote, Table of Contents and Index features, ALLWRITE is ideal for your reports and Term papers.

Circle 30 on Reader Service card.

HUNDREDS OF USEFUL CAPABILITIES

ALLWRITE comes with just about every useful word processing feature...standard. Here are some highlights: excellent right-justified proportional printing on most printers having that ability; powerful Form Letter and Mailing Label preparation; Instant counts of words, characters, lines, changes; block Move, Copy, Delete, Putfile, Getfile, and List; delete by character, word, line, sentence, paragraph, or block; insert and one-key insert; great RS-232 printer support; accepts all 256 ASCII codes from keyboard; intermix pitches on same line (printer-dependent); 1.5 line spacing, 6, 7, 8, 12 lines per inch (printer-dependent); does multiple-columns on all printers; perfect alignment of hanging indents; variables, logic statements, conditional printing; wildcard Directories; integrated with Electric Webster and DOTWRITER for Models I, III, and 4 (these are sold separately); "Legal" line numbering; paragraph, list, and figure numbering; supports most popular printers (all "printer drivers" included); compatible with high-memory drivers; fully explains all DOS and ALLWRITE error messages; wildcard search-replace; tabs, search-replace, other settings remembered across files; word reversal; up to nine levels of boldface; flexible page titles; footnotes at bottom of page or end of document; Table of Contents and Index generation; and PROSOFT's unmatched text formatting and printing capabilities.

Attention NEWSSCRIPT Owners

You can trade in your copy of NEWSSCRIPT at very substantial savings. Please call our technical line for details.

How To Order

You can order by phone or mail. For quickest delivery, call our Technical Support line. Please specify your TRS-80 model (I, III, or 4, 48K, at least two disk drives), and your printer(s). Our price includes normal shipping in the U.S. and Canada. The sooner you order, the sooner you will begin to benefit from the ALLWRITE! Word Processor.

~~\$249.95~~ \$199.95

ORDER NOW, TOLL-FREE

(800) 824-7888, oper. 422

PROSOFT®

Box 560, No. Hollywood, CA 91603

(818) 764-3131 for Technical Information and Same-Day Processing.

Terms: VISA, MasterCard, checks, C.O.D. California residents please add sales tax.
Most orders filled within one day.

Golden Template

Finally! Why didn't you think of it before? Spreadsheet Beat bodes to be your most useful column yet. What I'd like to see is a good check register template for Multiplan.

Andy Chakires
Ventura, CA

Readers can submit their templates to Spreadsheet Beat c/o 80 Micro, 80 Pine St., Peterborough, NH 03458. We pay \$50 for each one we use.

—Eds.

Tax Relief

Your March issue contained the only comprehensive article I've found on home computer income tax deductions. "Reasonable Deductions" by Lake, Golden, and Lett is clear and concise, and the examples are excellent.

G.C. Stanberry, Jr.
Houston, TX

Let the Games Continue

I think you're making a big mistake in discontinuing your annual games issue. You say games are now on the bottom of your readers' want list. What about readers like me who looked forward to the games issue? Are we going to be left out in the cold? I used to think your magazine was great because you covered all areas of computing: business, games, hobby, and so forth. But now it seems you're focusing only on business.

Randy Landgraf
McMinnville, OR

We're not dropping games altogether; we'll continue to publish them from time to time.

—Eds.

Line Item

In the February 1985 Basic Takes (p. 108), Richard Ramella makes the misleading statement, "...lower line numbers save memory..." Actually, Basic stores a tokenized line with a 2-byte hexadecimal line number, regardless of that line number's size. It is only those relatively infrequent GOTO and GOSUB lines that store the following number in a multibyte ASCII format. Therefore, if a program doesn't contain any GOTO or GOSUB lines, re-



numbering will not save space. Also, newer GW-type Basics store even GOTO and GOSUB lines in a tokenized 2-byte format, so you can't reduce memory requirements due to renumbering.

Frank Vanslager
San Jose, CA

I appreciate Mr. Vanslager's correction. The Model 4 and Tandy 1000 Basics don't give the results I indicated. Readers can use a simple test to determine if their computer can conserve memory by renumbering Basic listings. Type in:

```
50000 GOTO 50010
50010 END
```

Run the program, then type in your computer's command for displaying available memory, either PRINT FRE(0) or PRINT MEM, and press the enter key. Write down the number that appears. Erase the listing and type in and run the following program:

```
1 GOTO 2
2 END
```

Once more, display available memory; if the first number is higher than the

80 Micro's BBS is open 24 hours a day. It offers programs you can up- and download, special-interest groups, and a classified section. You can reach the board at 603-924-6985; UART settings are 300/1200 baud, 7-bit words, 1 stop bit, and even parity.

second, you can save memory by using lower line numbers.

If memory isn't a consideration, don't bother to renumber. But many users are still working with only 16K of memory. Sometimes they need, for example, to clear a few more bytes for strings, and this is a way to wrench that memory out of a long listing.

Richard Ramella
Chico, CA

Tandy Si

After reading the May 1985 Input page, I felt the desire to say a good word for Tandy and the Radio Shack people. Just over a year ago, I acquired a Model 4. I had never had my hands on any computer of any make or model. The Radio Shack staff struggled through my learning period with me, and I have nothing but praise for them. After all, why should a 74-year-old man be starting out to learn to operate a microcomputer?

Now I'm using a payroll package, Scripsit, VisiCalc, and General Ledger. As far as I'm concerned, the Model 4 is a good piece of hardware, and I have been pleased with the DWP-210 printer that I bought. Some day I may outgrow it.

R.T. Vaughn
Nashville, TN

CP/M No

You can find myriad applications programs that run under MS-DOS, TRS-DOS, and PC-DOS for business, education, math, communications, aviation, medicine, stamp collecting, and so on. Also, under those operating systems, which are easy to learn, remember, and use, you can develop and write programs in Basic, Pascal, C, Fortran, Cobol, Forth, and Assembly language.

So what is all this hype and hoopla about CP/M being now available for certain computers? Public domain programs? They lack documentation and are therefore of limited use. If computing is to go forward, we nonprofessionals need simpler systems, not expanded availability of a difficult-to-learn, complicated operating system like CP/M. One can hardly go forward by taking a backward step.

E.A. Morris
Sparta, NJ

Check these features:

Talker 2.0 and Talker 4.0 software:

- ✓ Unlimited translation of English text to clear speech.
- ✓ Powerful video or keyboard echo can be switched on or off at any time.
- ✓ Can be used in BASIC with 2 new commands: PRINT* "I can talk" speaks any expression. PRINT! "Hello" speaks *and* prints on screen.
- ✓ Reads numbers up to 999 trillion.
- ✓ Speaks many abbreviations, such as Mrs., Mr., lb., oz., Co., etc.
- Walks the dog.
- ✓ Many control codes to tailor the system to your wishes. (Pitch, speed, etc.)
- ✓ Only 6¼K long.
- ✓ Talker relocates itself into available high memory. Compatible with any DOS (not CPM).

The VS-100 hardware:

- ✓ Same performance as very expensive units.
- ✓ Super efficient: About 50 bytes per sentence.
- ✓ Handsome speaker module included.
- ✓ Detailed 48 page manual.
- ✓ Ready to plug in and talk right away.
- ✓ Uses the famous Votrax SC-01 with 4 pitch levels and automatic inflection.
- ✓ Built in audio amplifier with volume control.

See the detailed review in 80-Micro December 1984.

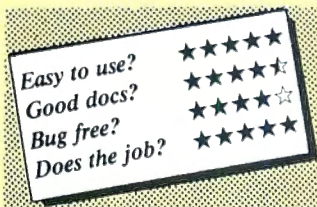

The VS-100: You've never had so much fun with your TRS-80

"Doctor SIGMUND" will amaze you!

See Artificial Intelligence at work!

If you want to show off your computer, run "Doctor SIGMUND" and see their expressions as your TRS-80 has an intelligent conversation with you. If you have a VS-100 voice synthesizer, Sigmund actually talks back to you. Even YOU will be impressed. **\$29.95**
 Doctor SIGMUND, for Models I, III and 4 (48K required); available on disk only

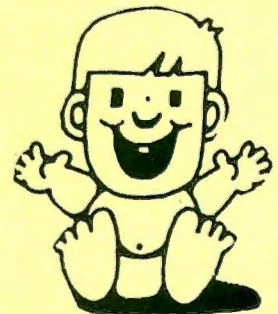

SPEECH

fun simple powerful

with the VS-100 voice synthesizer



The VS-100 system. (Model I shown)

\$ **69.95**

Includes:
 - VS-100 synthesizer
 - Speaker
 - Power supply
 - Manual

Specify Model I, III, 4 or 4P.

Model 4P needs short 50 pin extension cable 14.95

TEXT-TO-SPEECH SOFTWARE

- **Talker 2.0** for Models I and III
 On disk only..... 29.95
- **Talker 4.0** for Model 4. Includes Talker 2.0 for Model III mode. On disk only..... 39.95
- Text-to-Speech for tape users 19.95

Small Print: ● Model I: unit plugs into keyboard or expansion interface 40 pin bus. ● Model III, 4, 4P: unit plugs into 50-pin I/O bus. Model III VS-100 works with Model III, 4, 4P. Use our "Y-cables" (see next page) if your bus is already used.

Circle 17 on Reader Service card.

ALPHA Products

79-04 Jamaica Ave., Woodhaven, NY 11421

(718) 296-5916

Toll Free Order Line
800-221-0916

Orders Only. NY & info call
 (718) 296-5916
 Hours: 9-5 Eastern Standard Time

Add \$3.00 per order for shipping/handling. We accept Visa, Mastercard, Checks, M.O. C.O.D. - Add \$3.00 extra. N.Y. Residents add sales tax. Overseas, F.P.O. APO: Add 10%. Dealer discounts available.



Send your questions or problems dealing with any area of Tandy/Radio Shack microcomputing to Feedback Loop, 80 Micro, 80 Pine St., Peterborough, NH 03458.

Q: My students use cassette-based Scripsit modified to run at high baud rate. This speeds up operation and hasn't caused any problems with reliability. I use disk Scripsit 3.2 and would like to be able to load students' high-baud tapes or write to tapes they could use. What modification makes the program set the cassette recorder to high? (K. Edward Renner, Dalhousie University, Halifax, NS)

A: Here's a patch that modifies Scripsit 3.2 for high baud rate:

```
PATCH SCRIPSIT/CMD (ADD=5308,FIND=
AF321142,CHG=AF320000)
```

And here's the same patch for readers using Scripsit 1.0:

```
PATCH SCRIPSIT/CMD (ADD=5222,FIND=
AF321142,CHG=AF320000).
```

Q: I have a 128K Model 4P and a dual-drive 48K Model III with Radio Shack's double-density board. I have several questions about software and hardware.

First, I want to install Radio Shack's Scripsit Spelling Dictionary with SuperScripsit, but I'm missing the Install program. Can you describe how to install the dictionary?

Second, I've transferred Radio Shack's Haunted House from tape to disk, but the program comes in two parts. At the end of part 1, the message "Ready cassette-hit enter when ready" appears. I've located the message using Debug, and I want to change it to read "Loading second part-standby" and then call the second file and have it start execution. Although I appended part 2 to part 1, I'm unable to start executing the second part without going to DOS and typing in its filename. Any ideas?

My third question deals with Radio Shack's MicroChess program. I want to transfer it to disk but haven't succeeded, even with these utilities: COPY2/CMD, Tapedisk/CMD, Transfer/CMD, Whatzit/CMD, T2D2/CMD, Super Utility 2.2Z, and TRSDOS 2.7DD's Tape command. Can it be done?

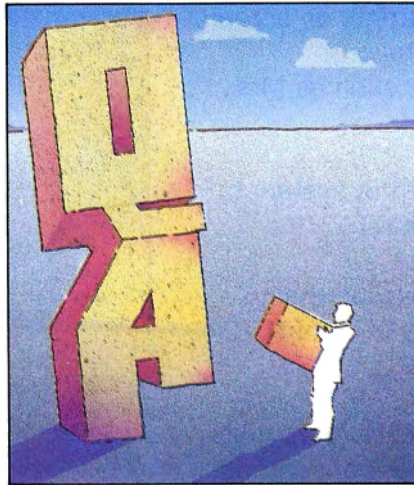

Fourth, can I use my Model I disk drives and a four-connector disk drive cable to make my 4P a four-drive system? My Model I drive zero has a power supply that operates drives zero and 1; would I need any additional equipment?

Finally, I'm thinking about getting an Aerocomp 30-megabyte hard disk drive to use as my primary drive, but I'd like to format and run the following operating systems on it: TRSDOS 6.2, LDOS 5.1.4, and Montezuma CP/M 2.2. I have TRSDOS 6.2's and LDOS 5.1.4's hard disk initialization routines. Can you describe the procedure for partitioning the hard drive for these systems? Do I need Montezuma Micro's hard disk drive support package to do it? (William Kirksey, Corpus Christi, TX)

A: You're using SuperScripsit in Model III mode. Before you install the dictionary, back up your SuperScripsit and Scripsit Dictionary disks. You should have a Proofread disk; back it up, too. Boot up the SuperScripsit disk in drive zero; at TRSDOS Ready, remove the disk and put the Proofread disk in drive zero. Put the Dictionary disk in drive 1. Type in KILL SPEDIT:1 and KILL CHECK/CMD:1, then type in COPY PROOF/CTL TO PROOF/CTL:1. That's all the Install program does: install the Proofread Control file on the dictionary disk after making some space for it.

As for Haunted House, I don't believe you can do what you want. The second part of Haunted House is supposed to run at a lower location in memory than where you have it. Moving it higher, as

you've done, makes some of the machine-language jumps incorrect. You need to add a short machine-language program to the end of part 2 that moves it to its proper location, then jumps to part 2's execution address. And you need to modify part 1 so that it automatically jumps to this machine-language routine when part 1 finishes.

I don't know about MicroChess—does anyone know how to get it to disk?

About those extra drives. I've finally discovered why it's so hard to put external drives on the 4P: The pins for those two drives aren't even connected to anything on the controller board. The Q2 and Q3 outputs from the floppy disk controller chip are left unconnected. To add external drives, you must go into your computer and hard-wire the outputs from Q2 and Q3 to an inverter chip and then onto the staking pins that your drive cable uses. You also need a new drive cable. You can't use the old Model I cables because the 4P uses a double row of 34 staking pins on the drive controller board to connect to the disk drive cable instead of an edgcard connection.

To use the hard disk drive with Montezuma Micro's CP/M you will, of course, need their hard disk support package. The operating system manuals describe the procedure for partitioning the hard drive. Basically, you lie to the operating systems about how much memory is available on the hard drive and where each system is supposed to find its section. The operating systems won't be able to share sections. CP/M won't recognize TRSDOS's sector/platter partitioning and vice versa, so each system will have access to only a portion of the hard drive's surface.

Q: My questions concern the Tandy 1000's TEAC disk drives. As configured, they use the TEAC 54B double-density, 40-track, nine-sectors-per-track format. I recently bought two TEAC 55F quad-density 80-track drives and would like to install them in my Tandy 1000. TEAC gave me the following DIP (dual in-line package) shunt configuration: DS1, HM, IU, and SM on both drives, with drive A having the termination.

After trying this configuration and several other combinations, I still can't get my system to boot up. I receive either

Newclock-80 \$69.95

The right time at the right price! Keep the time and date with quartz accuracy, even when your computer is off. The backup lithium battery (included) will last for over 2 years. Software on tape or disk, please specify. Use "TIMESET" once to set the clock. Use "SETCLK" to set your computer's internal clock (at power up) or use "TSTRING" so that the "TIME\$" function reads the Newclock. Connection: Model I: plugs into the keyboard or expansion interface. Model III: plugs into the 50-pin I/O bus. Compatible with all operating systems.

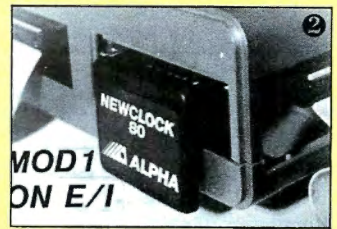

Printswitch \$59.00

Do you have 2 printers? Get a Printswitch. Stop plugging and unplugging those printer cables. With the Printswitch, you can have 2 printers connected to your computer and you can select either one at the flick of a switch. Works with any printer, plotter, or device that uses the parallel printer port. Simply plug the 14 inch Printswitch cable into your computer, and plug your existing printer cables into the Printswitch. This is the nicest unit on the market. Superior quality board with gold plated edge connectors. For Models I,III, 4 and 4P.

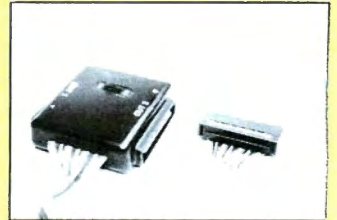

Alpha Joystick \$27.95

When it's time for fun, don't be without your Alpha Joystick. Do you know that most action games are Joystick compatible? Stop pounding on your keyboard and enjoy real arcade control. The joystick can also be used with BASIC programs; simply do J=INP(0) to read the joystick position (8 directions and fire button). Model I: plugs into keyboard or expansion interface. Model III, 4 and 4P: plugs into 50-pin I/O bus. The Alpha Joystick comes fully assembled and tested, ready to plug in and enjoy. (Specify Model I, or Model III,4).



Interfacer-80 \$159.00

Low cost input and output device. The outputs consist of 8 relays (rated 2 Amp @125V), easily controlled using "OUT" commands. For example, OUT 0.0 turns all the relays off. Eight LED's show the states of the relays. The 8 inputs are optically isolated, so it's safe and easy to connect external devices (switches, sensors, thermostats, etc.). Simple "INP" commands read the inputs. Connection: Mod I: 40 pin bus. Mod III, 4, 4P: requires 50-pin I/O bus converter (\$39.95), plugs into 50-pin I/O bus. Comes complete with power supply, cable, and detailed manual. (Up to 8 interfacers can be connected to your TRS-80 using our Y- cables).

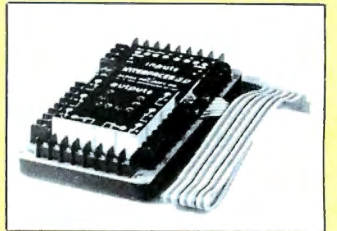

Analog-80 \$139.00

8 channel 8 bit Analog to Digital converter. Your TRS-80 can read voltages, temperatures, pressures, light levels, etc. • Input range: 0 to 5.1 Volts. • Resolution: 20mV. • Conversion time: 120 microseconds. In BASIC, you can take up to 100 readings per second. • Port address: selectable. Up to 8 Analog-80's can be connected to your TRS-80 for a total of 64 channels! Connection: Model I: 40 pin I/O bus. Model III, 4, 4P: requires 50-pin bus adapter (\$39.95). Comes complete with power supply, cable, and manual.



Special Cables

Disk drive extender cable (8")...C160:\$9.95

Y-Cable for Mod I bus (40 pin): •X2-40...\$29 •X3-40...\$44 •X4...\$59 •X5...\$74

Y-Cable for Mod 3 & 4 bus (50-pin): •X2-50...\$34 •X3-50...\$49 •X4-50...\$64

Disk drive cable (34 pin): •2-drive...C162:\$32 •4-drive...C163:\$45

Extension cable, 4 foot: •For printer and drive (34-pin)...C165:\$22

•For Mod I bus (40-pin)...C167:\$24 •For Mod 3 & 4 bus (50-pin)...C169:\$28

Keyboard to E/I (40-pin, 8")...C161:\$21 If this is confusing, send for our Cable Flyer. Our cables are made with high quality gold plated connectors to ensure utmost reliability.

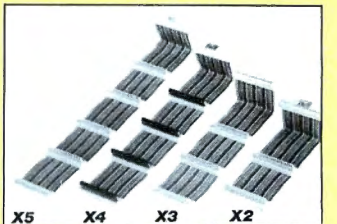

NO RISK

We know that ordering by mail can sometimes be a hassle, but with Alpha, you are fully protected.

- 1) Our 15 day money back guarantee protects you from disappointment.
- 2) All our products are tested on a TRS-80 and warranted for 90 days (parts & labor)
- 3) We ship 90% of our orders within 24 hours.
- 4) We are committed to help you

Green Screen \$12.50

Do you eyes a favor, put on a green screen. Tens of thousands are in use for a good reason: they work. Contrast is enhanced and eye fatigue is greatly reduced. Our green screen is curved; it fits right on the face of the tube. (Fits Models I,II,III,4,12,16)

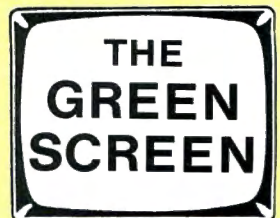

Circle 17 on Reader Service card.

ALPHA Products

79-04 Jamaica Ave., Woodhaven, NY 11421

(718) 296-5916

Toll Free Order Line

800-221-0916

Orders Only. NY & Info call
(718) 296-5916.

Hours: 9-5 Eastern Standard Time

Add \$3.00 Per Order For Shipping And Handling. We Accept Visa. Mastercard, Checks, M.O. C.O.D. Add Sales Tax. Overseas, FPO APO; Add 10% Dealer Discounts Available C.O.D. add \$3.00 extra.

FEEDBACK LOOP

a disk boot error message or a message to insert the disk. I've tried both MS-DOS 2.11 and PC-DOS 3.0, the latter supposedly supporting quad-density format. Will the 1000's disk controller recognize the higher density drive? If not, can you suggest a suitable replacement? Without technical documentation for the 1000, I can't proceed with this upgrade. (Donald J. Mangold, Verona, NY)

A: Are you trying to boot an 80-track disk? If not, that's probably your problem. Eighty-track units have twice as many tracks in the same amount of space as 40-track drives. With a 40-track disk in an 80-track drive, the drive is still reading the 40-track disk's first track when it moves to the second track. To make this work you must force the 80-track drive to increment two tracks instead of one. Unfortunately you can't do this with a hardware modification. The only solution is temporarily to put one of the 40-track drives back online as drive zero and to format and make a system back-up to the 80-track unit using the DOS SYSGEN command (see the manual for details). I believe you're supposed to set one drive to DS0 and the other to DS1. Double-check this with your technician as it's very important. If I'm right you have both 80-track drives configured as drive 1.

By the way, you can get Tandy 1000 technical manuals from Radio Shack's National Parts division (900 E. Northside Dr., Fort Worth, TX 76102, 817-870-5662.)

Q: Can you tell me who makes the CPU for Radio Shack's DMP-120 printer? The service manual lists the CPU as manufacturer's part number 2420NPEP159 and the label on the CPU reads "TEC 8403PX EP-159 Japan 7802068." When I asked Radio Shack's Consumer Service department about it, they said they couldn't give the manufacturer's name because it's a trade secret!

I opened the printer to repair a bad print head, and after that I started studying the CPU with a scope. I am slowly figuring it out but could go faster and better with a specifications sheet.

After less than an hour's use a print-hammer coil and its transistor went out. The coil, which normally has a resistance of 17 ohms, had heated enough to melt its plastic form and shorted to 1 ohm. What could cause such a thing in a new printer? (Jack Stuntz, Ft. Collins, CO)

A: TEC stands for Tokyo Electronics Co. They're at 222 Kearny St., San Francisco, CA 94108; they make the DMP-120's CPU.

I can attribute such a printer failure only to a defective part. I hope you made

Radio Shack do the repair, as the failure was well within the 90-day warranty period for defective parts or poor workmanship.

Q: I recently bought a 128K Model 4. When I load TRSDOS 6.X into RAM, I have only about 28K left. My old Model I left me with 38K of RAM. I need at least 38K to run my programs. Do you know of a Model 4 operating system that will leave me enough working room? (M. Muccolo, Floral Park, NY)

A: MULTIDOS or DOSPLUS gives you about that much room, with supply utilities that let you compress your programs to release more RAM for data and variable storage. Have you considered breaking up your program and using the Common and Chain commands to switch back and forth? That's what those commands are for.

Q: Several years ago, while in Japan, I bought a Model I from an authorized Tandy dealer. The equipment worked fine until recently, when drive zero started making a knocking sound. I took the bad drive to the local Radio Shack for repairs.

About five weeks later, when I asked about the drive, I was told the Radio Shack store wouldn't attempt to repair it without the proper schematics and repair manual, which were unavailable since the unit was manufactured in Japan. A label on the back of the drive reads, "Cat. No. 2601160A, Custom Mfd. in Japan for Tandy Radio Shack - AC 10V +/- 10%, 50/60 Hz." Do you know where I can get manuals and schematics for my equipment, or can you suggest another solution? (Jon C. Schultz, Sandusky, OH)

A: The only suggestion I can make is that you write directly to Tandy's Japanese division and ask for a service manual. Can anyone else help?

Q: I use a Model III with a DWP-410 printer. SuperScripts's user print codes are causing trouble with proportional spacing and right-justified margin. Codes for characters such as 1/2, 1/4, and @ make the printout line spill past the right margin. I double-checked the manual to make sure I was allowing the correct amount of space. What's wrong?

Also, when using Profile III Plus, I occasionally get an "I/O end of file" error when printing labels. This happens with one file only.

Finally, I'm considering getting a 10-megabyte hard disk drive to use with Profile III Plus. One file covers about 20 floppy disks and it would be best, I think, to keep this all together. Can I transfer data files to hard disk? Will Profile III

Plus run from hard disk? What problems can I expect? (Carl H. Sturner, Earlton, NY)

A: This is the first I've heard of such a problem with SuperScripts. Since the prescribed amount of room for your special characters isn't enough, have you tried incrementing the amount until you find the magic number that gives you perfect margins?

You obviously have a bad sector somewhere in that Profile III Plus file that's causing trouble. Try copying the file to a new disk. Or use a simple Basic program that loads each section of the file into memory and writes it to a new file name, displaying the information as it does so. This should help you pinpoint the bad area.

Yes, you can transfer your Profile III Plus files to hard disk. No, the version for standard floppy drives won't work off the hard drive. You have to buy a special hard drive version; it works just like the floppy version except that everything defaults to the hard disk. You shouldn't have many problems once you get used to the new equipment.

Q: As you know, the Model 4P has no cassette interface. I suppose Tandy thought a portable computer user had no business fooling with cassettes. Unfortunately, I use a 4P as my main computer and I certainly do need cassettes. I have a good supply of Model I software that I can't use. Do you know where I could get information about building a cassette interface for the 4P? Since the unit already has the Model III ROM on disk, which should include the cassette routines, it should be relatively simple to build such a device. Model 4 mode is unimportant; I'm only interested in loading my old Model I software. (Michael Czuhaiewski, APO, NY)

A: As yet, I haven't seen anything about a cassette modification for the Model 4P. One bit of warning though: Just because the 4P has a ROM image on disk doesn't necessarily mean the image includes the code for cassette routines. Can anyone help?

Q: I recently bought a kit to expand my Model 4P's memory to 128K. From the advertisement I assumed the kit would have instructions for both the Models 4 and 4P, but it contained instructions only for the Model 4.

I installed the chips in the empty RAM sockets and tried to access the new memory with MEMDISK. However, my computer displayed the message, "Unable to install MEMDISK, requested banks in use." I assume there's more to the upgrade than plugging in the eight 4164 chips. (Greg Denson, Hoover, AL)

A. There's more to it than just plugging in the chips. The Model 4 requires a PAL (programming array logic) chip to use the extra 64K.

The 4P doesn't need a PAL chip, but you must move the board jumper between pin E12 and E13 to pins E11 and E12. That tells the computer that the extra bank of RAM is available. Sounds as if you have something else already using that extra RAM.

After you've moved the jumper, try again. Begin at first base with just your DOS disk booted up: no special drivers, filters, or other programs in memory (the configuration routine disabled). Now try installing Memdisk using memory bank zero. If you get an error, something is wrong with Memdisk; bank zero doesn't use the extra RAM.

If you don't get any errors, turn off the computer and start again. This time choose just memory bank 1. If you again get the error, "Requested banks in use," it's time to trouble-shoot the chips you installed. Are they all oriented correctly, with their notches all pointing in the same direction? Try removing them and reinstalling them in a different order. If Memdisk still fails, you'll have to contact Radio Shack, as something is wrong with the program, the computer, or the chips.

Q. I have a cassette-based Model I Level II that I'd like to convert to disk operation. What do I need, where can I get some drives, and what will it cost? Can I do it myself? (Lawrence Kiefer, St. Ann, MO)

A. Upgrading requires an expansion interface to provide the disk controller circuitry and extra memory. Unfortunately, Model I expansion interfaces are becoming as scarce as hen's teeth.

The only company I know of still making them is MicroMint (561 Willow Ave., Cedarhurst, NY 11516, 516-374-6793). Micro Data Supplies (22295 Euclid Ave., Euclid, OH 44117, 800-321-3552) used to sell the LNW Model I Expansion Interface, but I don't know if they have any left. If you're handy with electronics, a series of articles starting in the October 1982 *80 Micro* tells you how to build your own.

Once you have the EI, you need to get a disk drive zero. Several companies sell them; check the *80 Micro* ads. Drive zeros differ from other drives in that they contain a terminating resistor pack. This electronically protects the disk drives and floppy disk controller from spurious electronic noise and properly ties the drive cable data lines to ground. Without this terminating pack, you risk ruining the floppy disk or disk drive controller circuits or both.

As a matter of fact, you could try looking in the *Computer Shopper's* classified ads. You might find someone willing to sell a Model I for less than it would cost you to buy an EI and new drives.

If you should get a Radio Shack EI, get Gold Plugs from EAP (P.O. Box 14, Keller, TX 76248, 817-498-4242). These solder onto the edge card connectors of your keyboard and expansion interface, eliminating corrosion that causes disk resets and data reliability problems between the keyboard, EI, and disk drives.

Next, get Aerocomp's Model I double-density board (Redbird Airport, Bldg. 8, P.O. Box 24829, Dallas, TX 75224, 214-339-8324). This doubles your drives' storage capacity and makes it much easier to run complex software. I've used their board in my computer for many years and never had a problem with it. It's also a snap to install.

Considering the cost of these items, however, it might be cheaper to buy a new Model 4 and upgrade it to disk drives instead.

Q. Your answer to Craig L. Cole's question about color expansions for the Model I (February 1985, p. 18) surprised me. You said you didn't know of any companies that made color boards for the Model I. The article "The 80 Goes Color" in the May 1983 *80 Micro* (p. 90) describes the construction of a high-resolution color board for the Models I and III. This board sounds made-to-order for Craig Cole. (Dell M. Garner, Poughkeepsie, NY)

A. Thanks for the reminder. Craig needs the June 1983 issue also, because the construction article was a two-parter.

Q. Our business college bought a Model II and a 20-megabyte hard disk drive from an individual; both are used but in good shape. Quality Computer Services originally sold the hard drive, but when we tried to register as the new owner, we discovered they were no longer in business. Our problem is that we have no documentation for the hard drive.

Due to an electrical problem, we glitched a portion of the boot, so we're unable to get a ready prompt and are locked out. Do you, or any of your readers, have some information on the Q.C.S. hard drive? One other question: We plan to run CP/M on the Model II and use the MUMPS language and the Fileman data base package. Also, we want to set up the Model II for more than one user. Is there a type of multiplexer we can use for multiple user access via the RS-232 port? Ideally, we'd want all users to be able to log on, but they'd have to

share actual CPU time. One company recommended using a switching multiplexer with CP/M and said we wouldn't need a special operating system such as Xenix. But other companies say multi-user operation on a Model II isn't available without Xenix. Any ideas? (Greg Casselman, Chillicothe, OH)

A. Can't help you with the Q.C.S. Hard Drive; can anyone else?

Radio Shack originally designed the Model II as a single-person work station. Multiplexing the CPU to more than one person will slow down the computer somewhat. I haven't seen any field operations using the Model II as you propose, but you can do it. You don't want to use CP/M, though; use MP/M, the multi-user version of CP/M.

You'll have to contact Digital Research about the particulars, but I believe you can easily and simply set up the Model II to accept inputs from the RS-232 ports. This would support three users, one at the keyboard and two via the two RS-232 ports. The disadvantage is that this severely decreases the amount of RAM available to each user. In fact, I think you'll find that each user will have only about 16K to work with.

What might be better would be to get a multiplexer for the hard disk and let separate computers access the hard drive individually.

Q. I bought and installed a Mapper I kit from Omikron for my Model I so I could run CP/M-based programs. I followed their installation instructions, including the capacitor modification (I have the new type CPU), but I still can't run CP/M. The message I get is "DBOS ERR ON A: BAD SECTOR". It's definitely not the drive or disk; I tried three different disk drives; also I got the same result using the master disk. TRSDOS works OK, though.

Since it's my understanding that Omikron is out of business, can you or one of your readers help me solve this problem? (George Verlinden, Westminster, CA)

A. Since you can't get even the master disk to boot up, I suspect your master disk is blown. If the problem were hardware, I suspect that even TRSDOS wouldn't work right.

You need a new disk. Omikron is still around; they're just keeping a low profile as they try to recover from Chapter 11 and make good on all the orders they were supposed to send customers. Write to Paul Kelley, 1127 Hearst St., Berkeley, CA 94702, with a description of your problem and you should be able to get a new disk.

Terry Kepner is a freelance writer and programmer, and an 80 Micro associate editor.



MONTEZUMA MICRO

PRESENTS

MONTE'S WINDOW™

NOTEPAD

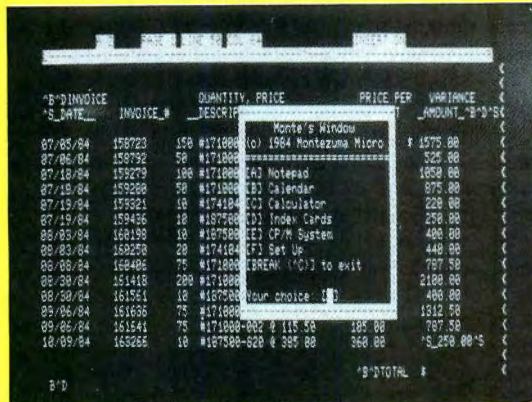
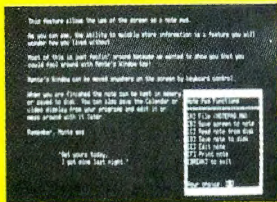

CALENDAR



**WINDOWS ON
YOUR MODEL 4!**

**TAKES NO
USER RAM!**



REQUIREMENTS

Montezuma Micro CP/M®
2.2 version 2.21+
128K RAM
Model 4 or 4P
8-bit Fever

CALCULATOR

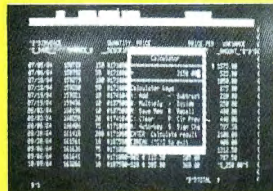

Pop Up Menus!

\$49

Easy to Use!

INDEX CARD FILE



A touch of the keyboard opens a window in your screen for—a Note Pad, an Appointment Calendar, a Calculator, even a Mini Data Base. All yours for just \$49! Need RAM? Monte's Christmas gift to you – 64K and the window, both for \$99!

Once Upon A Time,

Monte Zuma, our Founder, President and King, has always had trouble keeping his desk organized. The Sidekick™ from Borland International would solve the problem, but alas, it was not available for CP/M®. So Monte asked his favorite nephew, the legendary LaMont E. Zuma (distant cousin to Rondo Talbot, a direct descendant of Monte Zuma himself) to work on the problem as best he could during recess at the home. LaMont, a true legend in his own time, really outdid himself this time. A touch of both shift keys halts your application program in its tracks and up pops **Monte's Window™** ready to use. What could be simpler? Put an end to the fumbling and pawing around the pile of papers on your desk. You will find **Monte's Window™** indispensable. When you are finished, break back to your application program and it resumes without error. **Monte's Window™** is truly a breakthrough. See for yourself—Look through **Monte's Window™** on your Model 4. How did you ever get along without it? See the page opposite for order information. **Monte's Window™** is available right now.

CP/M...The Software Key That Unlocks Your Model 4

CP/M is the standard 8-bit Z-80 operating system and many thousands of programs have been written to run under this system. With Montezuma Micro's CP/M you can run these programs on your Model 4/4P. Think about all those nationally known programs you've wanted to use. Programs like WordStar, dBASE II; SuperCalc; MultiPlan etc. With our version of CP/M 2.2 all those public domain programs on bulletin boards across the USA are available for free downloading. CP/M is the missing link that joins all this software to your Model 4/4P. Montezuma Micro's CP/M comes ready to use and requires no hardware modifications. This product has been awarded the best and highest ratings in the reviews and we are continuously improving it with you in mind. With our CP/M you get more than just a DOS. You get the other half of your Model 4/4P.

AVAILABLE NOW FOR IMMEDIATE SHIPMENT - Less Hard Disk Drive Support..... \$169
Optional Hard Disk Drive Support \$ 30

(Radio Shack 5M, 12M, 15M, 35M • Aerocomp/Percom 5M, 10M, 15M, 30M • Bi-Tech 5M, 10M, 11M, 15M, 20M, 30M, 40M)

FEATURES

- Full range of floppy drive support. Dual-head and/or 80 tracks.
- Optional hard disk support allows positioning and selective assignment of logical drives. Easy backup routine.
- Memory drive allows the use of the other 64K RAM bank on 128K machines.
- Modem 7, a powerful public domain communications program furnished at no charge, allows for file transfer and remote database access such as CompuServ and The Source.
- CONFIG is our flexible utility that allows complete control of all operating parameters from menus. Format, read and write more than 30 different manufacturer's disk formats with more being added rapidly.
- Disk Utility Program allows fast format, backups and verifying of ours and other manufacturer's disks.
- These CP/M utilities are included: ASM; DDT; DUMP; ED; LOAD; MOVECPM; PIP; STAT; SUBMIT; SYSGEN; and XSUB.

WHY BUY OURS?

	MONTEZUMA MICRO	RADIO SHACK
Transient Program Area (TPA)	55K	52K
Bytes free in MBASIC	30,776	18,488
Bytes free of formatted disk	196K	160K
64K Memory drive	YES	NO
Double-Side/80tk drive support	YES	NO
Format, read/write other CP/M formats	YES	NO
Communication program included	YES	NO
Share HD with TRSDOS/LDOS	YES	NO
Assign multiple drives to HD	YES	NO
Boots from Hard Disk (4P)	YES	NO
Popular terminal emulation	YES	NO
User defined function keys	9	3
Timely product support	YES	NO

128K MEMORY UPGRADE

Our upgrade kit includes 64K RAM, a genuine PAL chip and instructions for installation. This kit will upgrade your 64K Model 4 to 128K and allow the use of our MEMLINK program and the TRSDOS 6.x MEMDISK. Guaranteed 1 year.

A BARGAIN AT ONLY \$74 Model 4
\$64 Model 4P - No PAL

This popular software is available for the Model 4/4P using our CP/M.

WordStar Fast memory-mapped version 3.3	\$250
MailMerge Multi-purpose file merging program ...	125
SpellStar 20,000 word proof-reader on a stick ...	125
StarIndex Creates indices and Tables of Content... ..	85
DataStar Data entry and retrieval is yours	175
ReportStar Report generator and file manipulator	150
InfoStar The above two programs	300
dBASE II with Disk Tutorial	385
CBASIC version 2.8	85
TURBO PASCAL by Borland. This is the one	45

ORDER INFORMATION

Call now and your order will be shipped immediately. We accept American Express, MasterCard and Visa plus we ship COD (cash or cashier's check only). Credit cards are not charged until your order is shipped. Add \$4 shipping per item on orders within the 48 states. Suitability of the software is the responsibility of the purchaser as there are **NO REFUNDS**. Defective items will be replaced upon their return, postpaid.

ORDER NOW ... TOLL FREE

800-527-0347
800-442-1310

The Toll Free lines are for orders only.
 Specifications subject to change without notice.

CP/M is a Trademark of Digital Research, Inc.; Interchange and Memlink are Trademarks of Montezuma Micro; TRS-80 is a Trademark of the Tandy Corporation; WordStar, MailMerge, SpellStar, StarIndex, InfoStar, ReportStar, DataStar, SuperSort and CalcStar are Trademarks of MicroPro International Corporation. Multiplan is a Trademark of Microsoft.

Copyright Montezuma Micro 1984.



MONTEZUMA MICRO

214-339-5104
 Redbird Airport, Hangar #18
 P.O. Box 32027
 Dallas, Tx 75232

"WE KEEP YOU RUNNING"



The PRODUCER
Winner of
★★★★★
FIVE STARS
in 80 MICRO Magazine's
Software Review

January 1985
The PRODUCER gained
this perfect rating
based on
Ease of Use
Quality Documentation
Freedom from Bugs
Ability to Do the Job.

You can quickly create programs
to manage such things as
mail lists, personnel records,
inventory control, catalogs,
loan calculations, schedules,
personal finances.
The only limit
is your imagination!

**THE PRODUCER
CAN SAVE YOU MONEY!** Why buy
expensive data base programs that never
quite do what you want. The PRODUCER
can write all your data storage and
retrieval programs for you -- quickly,
easily, and to your exact specifications.
Investing in The PRODUCER is money
saved over and over again.

**THE PRODUCER
CAN SAVE YOU FRUSTRATION!** No
more frustrating dependence on
inadequate software that someone else
packaged for mass consumer use. With
The PRODUCER you can design and
write custom software to meet your exact
needs. You can become a programmer
even though you have no previous
programming experience. The
PRODUCER helps you plan what you
want and then writes all the code for you at
the push of a button.

**THE PRODUCER
CAN SAVE YOU TIME!** What formerly
was impossible for novices, can now be
done with ease. What formerly took
professional programmers days and
weeks, can now be accomplished in
minutes. After a few hours going through
The PRODUCER's easy to follow Tutorial,
you will have an incredible time saving
tool at your fingertips. Most PRODUCER
users testify that they can create complete
programs from start to finish in as little as
fifteen minutes. You will soon be
wondering how you could ever have done
without The PRODUCER.



The PRODUCER Professional Program Writer

Beginners can program with no experience necessary.
Professional programmers can save days and weeks of time.

WITH THE PRODUCER YOU CAN ENJOY THESE OUTSTANDING FEATURES

- An easy-to follow tutorial that takes you step by step through The PRODUCER process. It's all you need to get started and even lets you create an actual program as you learn.
- The best screen generator available anywhere. You have full screen control including graphics. You can add, insert, delete and move blocks of text on screen or between screens.
- Full support for all math functions, including subtotals and global calculations.
- A B-Tree file structure, that gives extremely fast access to data, allows global search and replace, data entry by batch mode and automatic file rebuilding.
- The Freeform Report Generator provides amazing versatility to design text placement, interfield calculations and formats. You can even print reports on your standard forms.
- Full editing control at all times. You can easily edit and refine at any point, including the finished program, without having to start over. That's a feature not found on other products. The screen generator lets you experiment, rearrange, "cut and paste" between trial screens and change your mind any time you wish.
- A fully indexed reference manual of over 200 pages gives you complete technical support at your finger tips. You may never need to read it, but it is all there just in case.
- Outstanding technical support. Your PRODUCER package comes with four free issues of The PRODUCER quarterly newsletter. And should you ever need direct technical assistance, you may call a Producer Software technician for free counsel and trouble shooting.
- No payment of royalties. That's right. Provided you give proper credit, you may sell PRODUCER generated programs without paying royalties. Finished programs do not need the original PRODUCER system disk to run, so they are easy to duplicate and distribute. The PRODUCER can put you into the programming business for friends and associates.

★★★★★

"The longer I used The Producer, the more impressed I was. After only one month, it had found a place among my most often used software."

Hardin Brothers
Reviewer, 80 Micro

"The Producer is an excellent package, capable of doing everything I wanted it to.

Hardin Brothers
Reviewer, 80 Micro

"The Producer will allow you to develop a data base program in a couple of hours that would take months to program and debug by hand."

Charles Knight
Reviewer, Basic Computing

"The Producer is certainly one of the better buys in today's software marketplace."

Charles Knight
Reviewer, Basic Computing



TRS-80 Models
I, III, IV, 4-P

Requires 48K, 2 Disk Drives

\$199.95

1-800-433-5355

(TX) 214-456-0074

Ask about DATA SHUFFLER
All purpose Sort/Merge program.

We accept money orders, cashier's checks,
VISA, Master Card, and American Express.
Circle 76 on Reader Service card.

Tandy to 4P: Drop Dead

Tandyland

"The TRS-80 Model 4P went on sale on April 22, 1985, for \$649.95 and will remain at that price until the last one is gone. We've stopped production on the product and when the last one is sold, there will be no more 4Ps."

So spoke Tandy's director of market planning, Ed Juge, confirming speculation that Tandy's 8-bit transportable was on its way out (see the Photo). Only a month before, Model 4 line manager Stewart Weinstock denied that Tandy planned to discontinue either the 4 or the 4P. As for the Model 4, Juge insists that the desktop still has a long life ahead of it.

Juge said Tandy axed the 4P because "it was not a particularly hot seller," although he conceded that it has a loyal following. Juge added that 4P owners needn't worry about repairs and support. According to Tandy policy, parts will continue to be available for seven years after they sell the last machine. And as long as the Model 4 survives, users can find software for the 4P.

From the matter of the 4P, Juge went on to talk about Tandy's plans for MS-DOS computers. Stories in the *Wall Street Journal* and *Infoworld* last April cited speculation that Tandy would soon introduce two new MS-DOS computers: a portable, rumored to be the Tandy 800, and a PC AT clone, possibly called the Tandy 4000.

Juge called my attention to a statement by Tandy chairman John Roach summing up Tandy's attitude toward MS-DOS. Said Roach, "Obviously you've got to deduce that Tandy will stay in the forefront of the MS-DOS market and examine new products as the market evolves. In that way we will introduce products that make sense for us in that market."



Photo. Time runs out for the 4P.

But Tandy isn't in the clone business, according to Juge. When Tandy markets a product similar to another company's, he said, they try to take it further and make a better machine. "The only true clone we have is the Tandy 1200 and that was brought out because it was a good deal."

Juge said Tandy had no plans to bring out any new MS-DOS products before the end of summer, no laptops and no AT work-alikes. After that, we'll all just have to wait and see.

Price cuts on Tandy's computers were the rule last April. The Tandy 2000 and the 1200 each went down \$1,000 in price to \$1,999. The Model 12 was going for \$1,595, and the Model 100 took another price cut. Even the hot-selling Tandy 1000 was ripe for a markdown. Securities analyst Joan McKay of Kidder Peabody indicated Tandy would probably drop the price of the 1000 by 25 percent. Tandy's John Roach seemed to concur. "It can't stay up there forever," Roach said, referring to the 1000's current price tag of \$1,199.

All this price slashing is part of Tan-

dy's new aggressive pricing policy. But even a \$1,900 price cut might not be enough to keep the Model 12 alive. The low price sparked some interest in the 12 according to Tandy, but sales remained less than stunning. Competition from MS-DOS computers and from the remodeled Tandy 6000 hurt the 12's sales.

Still, the word from Tandy was that they wouldn't discontinue the Model 12 in the near future. Ed Juge explained the 12's huge price cut: "The cost of the Model 6000 has come down so dramatically with so much more horsepower that the price spread did not make much sense." In the past, an upgraded Model 12 cost \$4,099 while the Tandy

6000 cost \$4,495. Now Model 12 owners can upgrade for \$3,395, a difference Tandy hopes will help move the machine off Computer Center shelves.

It wasn't all glad tidings when Tandy announced its third-quarter earnings. Overall sales for the quarter were \$670.5 million, up from \$656.1 million for the same quarter a year ago. But earnings per share fell to 25 cents from 60 cents in 1984.

The share earnings drop resulted from an \$18 million write-off on computer hardware and software, goods that had declined in value since Tandy bought them. Tandy said declining prices for semiconductors and some computer subassemblies, as well as deterioration in market pricing of competitive equipment, made it prudent to write down raw materials and finished goods associated with the Tandy 2000. The write-off also included the cost of upgrading the Model 100 to 24K and the cost of some software associated with older computers.

The move might hurt Tandy's standing with investors, which had been high (see the June 1985 Pulse Train), but

John Roach sees benefits down the road: "This write-off of computer-related materials and products compensates for recent changes in market conditions and should permit us to continue to aggressively pursue our goal of providing outstanding value in microcomputer hardware and support."

Hot Items

Now that Tandy is committed to MS-DOS, some TRS-80 third-party software makers are following suit. Notable is Dallas-based Powersoft, which introduced an MS-DOS version of its venerable Super Utility disk-zapping package. In a simultaneous move, the company took the copy protection off the Model I/III/4 version and said it would provide Super U's/CMD file to registered owners for a small extra charge. The MS-DOS Super U costs \$89.95 for first-time buyers; registered TRS-80 version owners get a \$10 discount.

The Model I/III/4 version is widely considered an indispensable disk-repair utility, beloved by hackers and do-it-yourself types. In catering to the MS-DOS market, Powersoft took great pains to make the product easy to use and understand, even for users unfamiliar with disk-storage formats. Peter Norton's Norton Utilities has become the MS-DOS standard for saving disks and files. But TRS-80 owners are a loyal lot, and Powersoft is hoping their allegiance will help them find a place in Norton's neighborhood.

Powersoft's president, Dennis Brent, told me he wanted to avoid downgrading The Norton Utilities. In fact, Powersoft is pushing its new product not as an adversary to Norton's, but as a supplement that provides more utilities for saving files and reading blown disks.

While some old TRS-80 products are going MS-DOS, the opposite is also true. One of the trendiest MS-DOS applications, idea processing, is finally accessible to Model 4 owners in a product called Kamas. According to Adam Trent of Kamasoft, the program's manufacturer, Kamas works for people in text-intensive professions as an outline processor similar to ThinkTank, while at its highest level, you can use it to create custom applications, much like dBase II. At the time of the product's announcement, Kamasoft expected the program to run on the Models 4 and II/12/6000 running CP/M.

MicroTrends

Some of the big American micro-computer companies took their wares

Worldwide Microcomputer Word Processing Market, 1984		
Word Processor	Market Share (%)	Units Sold
Wordstar	24	290,000
Applewriter	22	254,000
Scrispit	13	150,000
PFS Write	8	92,000
Magic Word	7	80,000
Easywriter	4	32,000
Mul Simate	4	31,000
Word Handler	4	20,000
Peachtext 3000	4	48,000
Peafect Writer	3	33,000

Table. Top word processors in worldwide market share.

to West Germany last spring for Hannover Fair, the European equivalent of the Consumer Electronics Show. A number of hardware manufacturers, including Tandy, were showing Digital Research's new operating environment, GEM, on their equipment. Officially, however, Microsoft Windows is still the windowing product Tandy's backing. Microsoft didn't appear; in fact, its only obvious presence was through the many MSX (Japan's standard Microsoft operating system) machines at the fair.

Europeans seemed to be warming up to the 80186 technology Tandy pioneered in its Tandy 2000. Overseas firms showed interest in Intel's 80186 in anticipation of IBM's use of the chip in a new, low-end computer. The feeling in Europe is that IBM will use Intel's 80286 in the IBM PC II; the PC AT already uses the 80286.

One of the more interesting new product announcements to come out of Hannover Fair introduced Brother's Twinwriter 5, a double-action printer incorporating a daisy-wheel and a dot matrix printhead in the same housing. The daisy wheel puts out 36 characters per second (cps), while the dot-matrix alternative prints 140 cps. Brother is aiming the product at small businesses that need both printing capabilities.

Last year, word processors accounted for one-fourth of all applications software sold worldwide. According to Infocorp, 1.2 million packages went for an average price of \$275, for a total of \$300 million in sales.

The top five sellers in the word processing market worldwide included Radio Shack's Scrispit, which placed third with 13 percent of the market (150,000 units sold). Topping the list was Wordstar with 24 percent of the market, while Applewriter was a close second at 22 percent. PFS:Write was fourth with 8 percent; Magic Word with 7 percent came in fifth (see the Table.)

When I asked Tandy's Ed Juge about

Scrispit's strong showing, all he would say is that the figures probably weren't too far off—Tandy doesn't release actual sales totals for their products.

Update

As this column went to press, word came in from Fort Worth that Tandy expected to start an Express Order Hardware service in July or August. EOH complements Tandy's existing Express Order Software service, through which customers can order non-Tandy programs from Radio Shack stores.

According to Tandy's Deborah McAlister, the EOH system will carry peripheral items such as add-on cards, cables, and other noncomputing devices. Negotiations with manufacturers were still underway when I spoke with McAlister.

Tandy's support for Digital Research's GEM operating system became more concrete late last spring. The two companies signed an agreement that would make GEM, a graphics environment manager for MS-DOS computers, available through Radio Shack's Express Order Software service starting in June.

What's new on the small computer scene? Confusion, that's what. A recent market study by Frost and Sullivan distinguishes among four categories of portable computers. The smallest of the small are the lap-tops, like Tandy's Model 100/200 line. Briefcase computers, like Hewlett-Packard's HP-150 or the Apple IIc, come next. Of course, lap-tops fit into a briefcase, and you can use a briefcase model on your lap. But never mind. The two remaining categories are transportables, like Tandy's discounted Model 4P, and Apple Macintosh-type computers.

Frost and Sullivan predicts 5.9 percent annual growth for the portable market overall, but market prospects vary wildly from category to category. For example, the study points to declining sales in transportables, bearing out Tandy's decision to stop making the 4P. Prospects for laptop sales, in which Tandy is the industry leader, are better, although the survey warns that revenues may fall.

The biggest growth from now through the end of the decade should come in briefcase-size machines—14 percent growth in dollars, and 24 percent in unit sales. As for the Macintosh, Frost and Sullivan expects it to become the number-one portable computer, with unit sales jumping from 200,000 in 1984 to 550,000 in 1989. ■

TRS-80 AND IBM-PC Word Processing Program

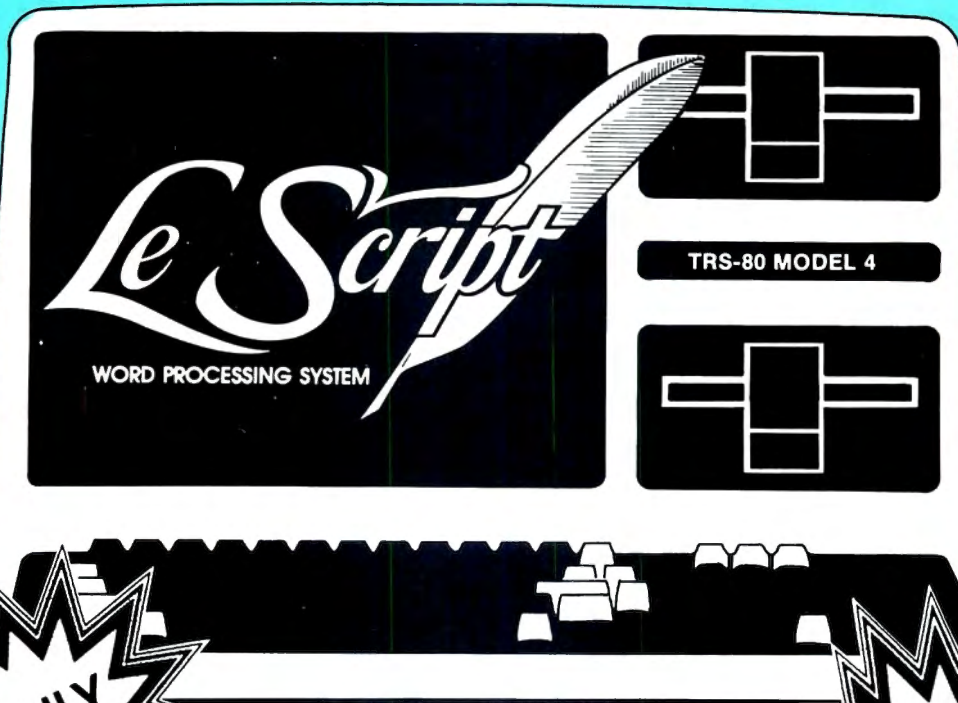

Computers Supported
 IBM-PC
 IBM-XT
 Tandy 1000
 Tandy 1200
 Tandy 2000
 Model 4
 Model 2
 Model 12
 Model 16
 Modem 4 CP/M
 Model 2 CP/M
 Max-80
 LNW

**ONLY
\$129.95**

**"For \$129.95 you'll be
hard-pressed to find a better
overall word processing product."
(LSI JOURNAL, January, 1984)**

**CP/M
& IBM
Versions
\$199.95**

- 80x24 DISPLAY using TRSDOS 6 or any MODEL III DOS.
- Built-in FORM LETTER and MAIL-MERGE capabilities.
- Built-in HELP SCREENS.
- 55 separately programmable MACRO FUNCTION KEYS.
- Performs PROPORTIONAL-SPACE right-margin justification on over 120 different printers (all drivers included FREE).
- Integrates with ELECTRIC WEBSTER spelling checker.
- Keyboard entry and printing of 31 European Characters and special symbols.
- IBM-PC, XT, Tandy, -1000, Tandy-1200, Tandy-2000 versions for color or Monochrome, now only \$199.95.
- MODEL 2/12/16 versions now available for TRSDOS 2.0, TRSDOS 4.2 and CP/M.
- LeScript also available to run on TRS-80 MODEL I, MODEL III, LNW-80, LNW-TEAM (80x24), Holmes VID-80 (80x24), and Lobo MAX-80 (80x24). \$199.95

FREE

TRIAL-SIZE DISK OFFER

Fill out and return this coupon to receive a free trial-size copy of the LeScript word processing system - a \$25.00 value.

Name _____

Address _____

City _____ State _____ Zip _____

Telephone _____

My system is:

- | | | |
|--------------------------------------|--|--|
| <input type="checkbox"/> Model I/III | <input type="checkbox"/> Holmes VID-80 | <input type="checkbox"/> CP/M LNW-TEAM |
| <input type="checkbox"/> Model 4 | <input type="checkbox"/> Model II | <input type="checkbox"/> CP/M VID-80 |
| <input type="checkbox"/> MAX-80 | <input type="checkbox"/> CP/M Model 4 | <input type="checkbox"/> TANDY-2000 |
| <input type="checkbox"/> LNW-TEAM | <input type="checkbox"/> CP/M MAX-80 | <input type="checkbox"/> IBM PC |

Send to: ANITEK • P.O. Box 361136 • Melbourne, FL 32936

CALL 1-305-259-9397

ANITEK SOFTWARE PRODUCTS

P.O. BOX 361136 □ MELBOURNE, FL 32936



FREE SHIPPING WITHIN THE U.S.; OUTSIDE THE U.S. ADD \$10.00 FOR SHIPPING;
 FLORIDA RESIDENTS ADD 5% SALES TAX. ALL ORDERS PREPAID BY CHECK,
 MONEY ORDER, CREDIT CARD OR C.O.D. Circle 141 on Reader Service card.

PERRY COMPUTERS



CALL
1-800-248-3823

COLOR COMPUTERS

	LIST PRICE	OUR PRICE
26-3127 64K Extended Color Computer 2 . . .	\$219.95	\$169.00
26-3136 16K Extended Color Computer 2 . . .	159.95	130.00
26-3129 Thinline Disk Drive O for Color Comp . . .	349.95	290.00
26-3018 Extended Basic Kit	39.95	36.00
26-3030 OS-9 with Editor Assembler	69.95	59.50
26-3012 Deluxe Joystick	39.95	25.00
26-1208 CCR-81 Recorder	59.95	50.00
VIP Integrated Library	149.95	139.00
VIP Writer	69.95	59.00
VIP Calc	69.95	59.00
Teletwriter Disk		59.00
Botek Interface		57.00

TANDY 2000

26-5103 Tandy 2000 Two Disk	\$2499.00	\$1225.00
26-5104 Tandy 2000 One Disk & 10 Meg HD	3950.00	1885.00
26-5111 Monochrome Monitor	199.95	165.00
26-5112 Color Monitor	649.00	535.00
26-5140 Hi Res Graphic Monochrome Board	359.95	305.00
26-5141 Hi Rec Color Graphics Chips	149.95	125.00
26-5160 Internal 128K Memory Board	299.00	250.00
26-5300 Lotus 123	495.00	420.00
26-5311 Microsoft Multiplan	195.00	166.00
26-5320 Framework	695.00	590.00
26-5352 dBase II (Data Base)	595.00	420.00
26-5330 Multmate	249.00	205.00

MODEL 200 COMPUTERS

26-3860 24K Model 200 Portable Comp.	\$999.00	\$725.00
26-3866 24K RAM Mem. Exp. Chip for 200	249.95	210.00
26-3804 AC Adaptor	5.95	5.00
26-3805 Acoustic Coupler	39.95	34.00
26-3816 8K RAM Memory Expansion Chip	119.95	95.00
26-1409 Printer Cable	14.95	12.70
26-1410 Modem Cable	19.95	17.00
26-3809 Briefcase	49.95	42.50
26-3811 Soft Carrying Case for 100/200	39.95	34.00
26-1183 Bar Code Reader	99.95	85.00
26-3806 Disk Video Interface	799.00	660.00
26-3829 Multiplan ROM for 100	149.95	127.50

MODEL 4 COMPUTERS

26-1069 Model 4 64K 2 Drive Computer	\$1299.00	\$ 945.00
26-1126 Mod 4 H1 Resolution Board	249.95	210.00
26-1122 64K Memory Expansion	79.95	75.00
26-1127 Model 4 Internal Drive 1	499.95	415.00
26-1123 Model 3 to Model 4 Upgrade Kit	799.00	675.00
26-1084 Model 4P Modem Board	149.00	85.00
26-1085 Model 4P Travel Case	24.95	21.25
26-1530 Multiplan Model 4	199.00	169.00
26-1595 Super Scripsit Model 4	199.95	169.00
26-1635 Profile 4 Model 4	249.95	212.00
26-2216 CP/M Plus Model 4	149.00	127.00
26-2231 Double Duty Utility	69.95	58.00

MODEL 12 & 6000 COMPUTERS

26-4005 Model 12 80K 2 Drive Computer	\$3999.00	\$1300.00
26-6021 Model 6000 512K 2 Drive Comp.	4499.00	3125.00
26-6022 Model 6000 512K 15Meg HD	5499.00	3795.00
26-6014 Model 12 to 6000 Upgrade	1595.00	1325.00
26-6015 Model 6000 512K Memory Board	1095.00	905.00
26-6016 Model 6000 512K Memory Kit	849.00	705.00
26-6017 Card Cage for Model 12	199.00	169.00
26-6052 DT-100 Data Terminal	795.00	600.00
26-4155 15 Meg Hard Drive Primary	1995.00	1395.00
26-4171 35 Meg Hard Drive Primary	2995.00	2095.00
26-4157 Installation Kit for Primary HD	349.00	265.00

RADIO SHACK PRINTERS

	LIST PRICE	OUR PRICE
26-1276 DMP-105 Dot Matrix Printer	\$ 199.00	\$ 169.00
26-1275 TRP-100 Portable Thermal Printer	299.00	230.00
26-1271 DMP-110 50/25 cps Printer	399.00	299.00
26-1268 CGP-220 Color Ink-Jet Printer	699.00	345.00
26-1278 DWP-220 Daisy Wheel	599.00	460.00
26-1277 DMP-430 24 Wire Matrix Printer	899.00	745.00
26-1270 DWP-510 43 cps Daisy Wheel	1495.00	1100.00
26-1274 DMP-2100P 24 Dot Wire Matrix	1995.00	1270.00
26-1272 LMP-2150 Line Printer	3995.00	1575.00
26-1269 PT-64 Printer Controller	249.95	210.00
26-1498 SW-302 Printer Switch	119.95	100.00
26-1401 Printer Label	39.95	34.00

TANDY 1200

25-3000 Tandy 1200 One Disk & 10 Meg HD	\$2495.00	\$1525.00
25-3010 VM-3 Green Monitor	219.00	185.00
26-3212 CM-2 Color Monitor	549.95	390.00
25-3040 Monochrome Display Adapter	219.00	185.00
25-3043 Graphics Display Adapter	299.00	255.00
25-3044 Graphics Master	695.00	590.00
25-3061 Captain Multifunction Board	795.00	675.00
25-3130 MSDOS/BASIC	89.95	76.50
25-3170 Wordstar Professional	395.00	335.00
25-3160 Framework	695.00	590.00
25-3161 PFS File	140.00	119.00
25-3190 dBase III	695.00	590.00

TANDY 1000

25-1000 Model 1000 128K 1 Disk Drive	\$1199.00	\$ 845.00
25-1003 Modem Option 1000/1200	179.95	128.00
25-1004 Memory Exp 128K 1000/1200	299.95	205.00
25-1005 Disk Drive Expansion 1000	299.95	170.00
25-1006 RS-232C Interface 1000/1200	99.95	85.00
25-1007 Hard Disk Control Board	329.95	255.00
25-1009 2nd Memory Board	249.95	185.00
25-1501 MS-DOS Reference T-1000	34.95	29.00
25-1502 BASIC Reference T-1000	34.95	29.00
25-1155 Scripsit 1000	299.95	255.00
26-3211 VM2 Green Monitor	149.95	125.00
26-3212 CM2 Color Monitor	459.95	390.00

EPSON/COMREX PRINTERS

20001015 Homewriter 10	\$ 288.00	\$ 230.00
20001025 LX-80 Dot Matrix Printer	369.00	250.00
20001030 FX-80 Dot Matrix Printer	499.00	385.00
20001040 JX-80 Color Dot Matrix Printer	699.00	485.00
20001050 HI-80 4 Pin Plotter	599.00	390.00
20002010 RX-100 Dot Matrix Printer	499.00	400.00
20002020 FX-100 Dot Matrix Printer	689.00	505.00
20003010 LQ-1500 18 Pin Head with Intf	1350.00	1095.00
20003510 CR-IIIE Comrex Com Riter	499.00	400.00
20001510 FX-80 Tractor Feed	39.95	34.00
20004080 NLQ Parallel Intr	209.95	175.00
20001515 LX-80 Tractor Feed	49.00	40.00

For Technical Questions and Information on our complete line of computer accessories and current prices.

CALL 1-517-626-4161
FOR ORDERS ONLY CALL 1-800-248-3823

All prices and offers may be changed or withdrawn without notice. Advertised prices are cash prices. C.O.D. accepted (\$10.00 charge per carton on C.O.D. Call for further C.O.D. information.) M.C., Visa, AX, add 2%. All non-defective items returned will be subject to 10% restocking fee. Defective items require return merchandise authorization. Call for R.M.A. Number before returning. Delivery is subject to product availability.

124 S. MAIN ST. PERRY, MICH. 48872

The Mad Patcher

Here's an improved version of one of my TRSDOS 1.3 patches ("Patch Work," January 1985, p. 112). Patch 8 modifies the Free command to give you the total number of free granules on a disk, but the patch also shortens a prompt in the rarely used Prot (PW) command. No big deal, but the patch below doesn't affect the Prot prompt:

```
PATCH *6 (ADD = 5483, FIND = 26, CHG = 3C)
PATCH *6 (ADD = 5526, FIND = 4D61737465
7220, CHG = FE28D8F1C3FC5B)
PATCH *6 (ADD = 5D52, FIND = FE28D0,
CHG = CD2655
```

You must install all three patch lines. Also, if you already have patch 8 in place, you must undo it by reinstalling the original patch, swapping the numbers in the three patch lines' Find and CHG fields.

For truly masochistic readers, I have a 29-line, wall-to-wall patch that inserts

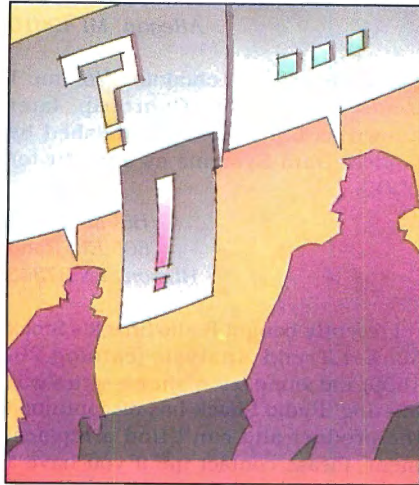

the CAT command in the TRSDOS 1.3 Help listing, replacing the nonfunctional Route command. I'll be happy to mail the patch listing to anyone who sends me a stamped, addressed envelope and

a dime to cover copying costs. I'll also include the listing for an experimental patch that lets you run TRSDOS 1.3, once booted, from drive 1 in a two- or three-drive system.

Andy Levinson
11575 Sunshine Terrace
Studio City, CA 91604-3835

Look for a sequel to "Patch Work" in this issue.

—Eds.

Zap Gap

The Figure shows changes to David A. Williams' Disk Zapper ("Zap Master," April 1985, p. 62) for editor/assemblers other than MZAL. We'd like to thank Thomas E. Oakes of N. Liberty, IN for bringing them to our attention.

—Eds.

DD Diagnosis

I discovered a zap to Dave Stambaugh's Floppy Doctor diagnostic program—the zap lets Model I owners using Radio Shack's double-density modification test for single- and double-density operation. You make the zap to relative sector 223 on the diagnostic disk. I used NEWDOS/80's Superzap utility. If you use Superzap, make sure the drive you're using has the following single-density PDrive attributes:

```
TI = A, TD = A, TC = 35, SPT = 10, TSR = 3,
GPL = 2, DDSL = 17, DDGA = 2
```

If the diagnostic disk is in drive 1, invoke Superzap and type in:

```
DD <enter> (Display a disk sector)
1,223 <enter> (Display sector 223 on drive
1)
MOD17 (Modify byte 17 in the sector)
```

Now, change

```
EC 37 36 FF 36 D0
```

to

```
EE 37 36 80 36 E0
```

by typing in the second set of 6 bytes. Press the enter key, press "Y," press the enter key again, and type in EXIT.

To use the modified disk for double-density testing, you must have the test disks in double-density format. Also, readers who don't want to alter their original diagnostic disks can create a

```
Change line 120 to: 120 ORG 3100H

Insert the following macro code expansions immediately
after the ORG statement:

SVC MACRO #V1
LD A,#V1
RST 28H
ENDM

CPR MACRO #V1
SCF
CCF
SBC HL,#V1
ENDM

MOVI MACRO #V1,#V2,#V3
LD DE,#V1
LD HL,#V2
LD BC,#V3
LDIR
ENDM
```

Depending on your editor/assembler, you might also have to make the following changes:

In lines 1210, 1270, and 1400, change the code LD BC,IX to two lines:

```
PUSH IX
POP BC
```

In line 3270, change the code LD HL,IX to two lines:

```
PUSH IX
POP HL
```

You might have to change the labels MOD, MODA, NOT, and NOTA if MOD and NOT are reserved words in your assembler.

EDAS users should also make the following changes:

```
03910 DC 14,' '
03920 DC 00,' '
03940 DC 14,' '
03950 DC 00,' '
04280 DC 00,' '
04290 CMD DC 00,' '
04300 DC 160,' '
```

Figure. Modifications to Disk Zapper for editor/assemblers other than MZAL.

TRS 80 Computers

All Tandy Computer Products Available
Manufacturer's Warranty

Model 1000	Model 4
Model 1200 HD	Model 100/200
Model 2000	26-5111 Monitor

New Tandy Printers Available

Lowest Prices Available Anywhere

Visa — MasterCard — American Express
Cashier's Check — Money Order

Business Telephone Systems—Discount Prices—
Install your own. Completely modular.
Call for Prices

Computer Specialist available for assistance.

TALLEY COMMUNICATIONS CO.

P.O. Box 193 • 121 N. State St.
Decatur, Texas 76234 • 817-627-5585 • 817-627-1017
Call for other computer, telephone and accessory prices!

Fast Delivery

References Available

LOG SUPERLOG and SUPERLOG 4

KSoft's Electronic Notebooks. Free-format information management for the 90% of your information needs that won't fit into a data-base or spreadsheet. 1024 characters per page. Lightning fast search and retrieval. Interrupt activated and accessible while another program is running.

A LOG or SUPERLOG Electronic Notebook is designed to replace your diary, address book, memo pad, card file, calendar, and scratch pad — so conveniently you will use it all day long. Call today for more information or immediate shipment.

SUPERLOG 4	for Models 4 and 4P	TRSDOS 6	\$119.95
SUPERLOG 3	for I, III, 4 and 4P	LDOS 5.1	\$119.95
LOG	for Model I	TRSDOS 2.3	\$ 49.95
LOG	for Model III	TRSDOS 1.3	\$ 49.95

KSoft Inc. (601) 992-2239 CIS 70075,137
318 Lakeside Drive
Brandon, MS 39042
MasterCard or Visa accepted
Add \$5.00 for shipping and handling
Dealer inquiries welcome

(TRSDOS is a trademark of Tandy Corporation)
(LDOS is a trademark of Logical Systems Inc.)

Mail-Order
Electronics

Mail Order Electronics - Worldwide
Jameco
ELECTRONICS

Worldwide
Since 1974

NEW!

Attention TRS-80 Model 100 Owners!

Pack a Purple in your Portable!

PURPLE COMPUTING E-X-P-A-N-D Your Model 100

Easy to install module plugs right into the socket increasing memory in 8K increments. Complete with module and documentation for conversion.
M1008K (TRS-80 Model 100 Expansion) \$49.95



MPI 5 1/4" Disk Drive TRS-80 Owners!

- Use as a second disk drive • Single-sided
- Single/double density • Full height drive
- 48 TPI • Documentation incl. • Wt.: 3.7 lbs.

\$89.95 ea.

Part No. MPI51S. or 2 for \$159.95

Enclose your second disk drive with JMR 5 1/4" disk drive enclosures.

- Houses one full ht. 5 1/4" disk drive • Unit complete w/power supply, switch, power cord, fuseholder & connectors • Size: 5 7/8"W x 3 3/4"H x 1 13/16"D • 5.2 lbs.

DDE-1FH. \$69.95

TRS-80 Model I, III & Color Conversion Kit

TRS-80 to 16K, 32K, or 48K

- **Model 1 = From 4K-16K Requires (1) One Kit
- Model 3 = From 4K-48K Requires (3) Three Kits
- Color = From 4K-16K Requires (1) Kit

**Model 1 equipped with Expansion Board up to 48K Two Kits Required
— One Kit Required for each 16K of Expansion —

TRS-16K3 200ns for Color & Model III. . . \$6.29
TRS-16K4 250ns for Model I. \$5.49



TRS-80 Color 32K or 64K Conversion Kit

Easy to install kits come complete with 8 ea. 4164-2 (200ns) 64K dynamic RAMs and conversion documentation. Converts TRS-80 color computers with D, E, ET, F and NC circuit boards to 32K. Also converts TRS-80 color computer II to 64K. Flex DOS or OS-9 required to utilize full 64K RAM on all computers.

TRS-64K2. \$17.95

NEW! TRS-80 Model IV 64K or 128K Conversion Kit

Easy to install kit comes complete with 8 ea. 4164 (200ns) 64K dynamic RAMs and conversion documentation. Converts TRS-80 Model IV computers from 16K to 64K. Also expands Model 4P from 64K to 128K.

TRS-64K2. \$17.95

(Converts the Model IV from 16K to 64K or will expand the Model 4P from 64K to 128K)

TRS-16K2PAL (Model IV only). \$38.95

(8-4164's with PAL Chip to expand from 64K to 128K)



ULTRA MAGNETICS 5 1/4" DISKETTES

All diskettes are soft-sectored w/hub rings. Bulk prices available on request.
SSDD = Single Sided Double Density • DSDD = Double Sided Double Density

Part No.	Description	Boxed	Price
UM51401	SSDD with Hub Ring	10	\$14.95
UM52401	DSDD with Hub Ring	10	\$22.95

Disk Minder DM75 Stores 75 (5 1/4") Diskettes. . . \$19.95

We also specialize in integrated circuits, custom cables, power supplies, keyboards, and much, much more! Give us a call today!

\$10.00 Minimum Order — U.S. Funds Only CA Residents Add 6 1/2% Sales Tax Spec Sheets — 30¢ each Shipping — Add 5% + \$1.50 Insurance Prices Subject to Change Send S.A.S.E. for Monthly Sales Flyer! Send \$1.00 Postage for your FREE 1985 JAMECO CATALOG!



Mail Order Electronics - Worldwide
Jameco
ELECTRONICS



1355 SHOREWAY ROAD, BELMONT, CA 94002
8/85 Phone Orders Welcome (415) 592-8097 Telex: 176043

ANYONE CAN USE OUR SOFTWARE!



MAIL PAC II and CHECKING PLUS represent a new generation of computer software. Our software doesn't even need a manual! Anyone can quickly learn to use either package by following simple, explicit on-screen instructions. But, for those of you who insist -- we've included a complete user's manual as well.

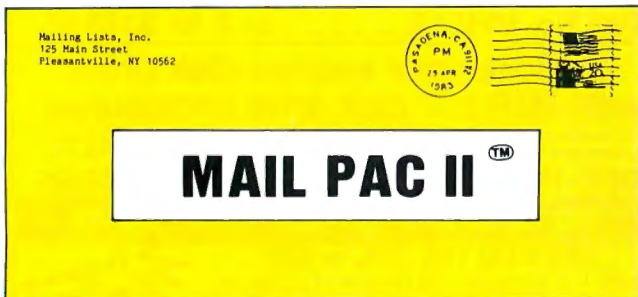

MAIL PAC II FEATURES:

High Capacity --

Stores from one to one million names in Zip Code, Numerical or Alphabetical order. The only limitation is your disk storage space.

Flexibility --

Prints your mailing list on 1, 2, 3, or 4-across labels (with up to 5 user-defined lines on each label) or as a compact, user-designed directory. The record length is completely user-defined, and each field within each of your records is completely variable (allowing storage of any number of characters for any particular address entry). Devote fields to telephone numbers, codes, or even special messages related to each particular name on file.

Powerful --

A built-in word processor allows you to create personalized form letters for each address on your list (or just a particular group of addresses).

Ease of Use --

Create new mailing lists, review existing lists, handle changes of address, delete cancelled names, sort lists, and purge duplicate names from your files. Complete on-screen instructions tell you in plain english exactly how to accomplish all of these tasks.

MAIL PAC II \$99.95

CHECKING PLUS FEATURES:

Complete Check Register --

Checking Plus stores your entire check register in a disk file, and then uses the data to balance your account, track your expenses, and help you make budget projections. Review the entire checkbook, enter checks, deposits, fees and adjustments, mark outstanding checks when paid, and get an instant cash balance at any time. All data can be viewed onscreen or printed out in report form.

Tax Preparation --

Storage of monthly and yearly totals and other important information aids in income tax preparation, for your personal use or for your accountant.

Handles the Details --

Store names and addresses for frequently written checks, then print checks to fit standard window envelopes, eliminating the need for extra typing. You can even store any comment, explanation or other message (up to 255 characters) related to a particular check.

Automatic Monthly Bill Payments --

Enter amounts and names of payees for all of your fixed-cost monthly payments, and then sit back while the system automatically prints checks.

CHECKING PLUS \$99.95

Both Programs Require 48K And At Least One Disk Drive (2 Drives For Higher Storage Capacities). And All Hard Disk Systems Are Supported.

FREE—TRS-80 Mod I,III & 4 programs supplied on DosPlus (minimum system). Complete DosPlus also available.

FOR YOUR TRS-80™ • APPLE™ • IBM PC™ • NEC™ • OSBORNE™ • XEROX™ • KAYPRO™ • TELEVIDEO™ • ZENITH™ • SANYO™
DEC™ • TI PROFESSIONAL COMPUTER™ • SUPERBRAIN JR.™ • EPSON™ • Any CP/M™ Computer
CP/M-based Computers must be equipped with Microsoft BASIC (MBASIC or BASIC-80)

TRS-80 trademark Tandy Corp. - APPLE trademark Apple Corp. - IBM PC trademark IBM Corp. - ATARI trademark Atari, Inc. - OSBORNE trademark Osborne Corp. - XEROX trademark Xerox Corp. - KAYPRO trademark Non-Linear Systems, Inc. - TELEVIDEO trademark Televideo Systems, Inc. - SANYO trademark Sanyo Corp. - NEC trademark NEC Corp. - DEC trademark Digital Equipment Corp. - ZENITH trademark Zenith Corp. - TI PROFESSIONAL COMPUTER trademark Texas Instruments, Inc. - SUPERBRAIN trademark Intertec Corp. - CP/M trademark Digital Research - EPSON trademark Epson Corp.

OUR SOFTWARE CATALOG

H & E Computronics, Inc., has mailed more than 1 million software catalogs since 1978. Send \$2 for our new 64-page catalog today! (We also send you our catalog FREE with every order). DEALER INQUIRIES WELCOME

30-DAY MONEY BACK GUARANTEE

*** ALL PRICES & SPECIFICATIONS SUBJECT TO CHANGE ***
DELIVERY SUBJECT TO AVAILABILITY

COMPUTRONICS

50 N. PASCACK RD., SPRING VALLEY, N.Y. 10977

24 HOUR
ORDER
LINE
(914) 425-1535

ADD \$3.00 FOR SHIPPING IN UPS AREAS
ADD \$4.00 FOR C.O.D. OR NON-UPS AREAS
ADD \$5.00 TO CANADA & MEXICO
ADD PROPER POSTAGE OUTSIDE OF U.S.,
CANADA & MEXICO

**NEW TOLL-FREE
ORDER LINE**
(OUTSIDE OF N.Y. STATE)
(800) 431-2818



Superlog 4: A Flexible Data Base at the Ready

by Gary Ludwick

★★★★★

Superlog 4 runs on the Model 4/4P (64K, 128K recommended) and requires TRSDOS 6.X. KSoft Inc., 318 Lakeside Drive, Brandon, MS 39042. Express Order Software number 90-0291. \$119.95. Utilities package \$49.95.

Easy to use: ★★★★★☆

Good docs: ★★★★★★

Bug free: ★★★★★★

Does the job: ★★★★★★

Superlog 4 is the kind of data base I like: It accommodates the unpredictability of human nature.

Rather than enforcing the rigid, unalterable structure of traditional data bases, Superlog lets you change Model 4 records and fields at any time: You add new information to existing records wherever you need to. But that's not Superlog's only remarkable feature. In a 128K system, you can run Superlog concurrently with another program, calling up the data base from high memory when you need it. Also, Superlog lets you read data from or write data to other files. Finally, Superlog 4 provides a set of utilities that enhance program operation.

How It Works

KSoft describes Superlog as an "electronic notebook" rather than a data base to emphasize its flexibility—you can add information to the data base as you would to a notebook. For example, say you have a notebook of names and addresses and you want to add telephone numbers. You call up the records of interest (or all records) and enter a new field and the phone number. It's that simple.

Superlog acts like a series of notebooks. Each notebook (data base) can hold 32,767 pages (records), each of which stores up to 1,024 characters. How many data bases you create is limited only by the number of blank disks you want to buy.

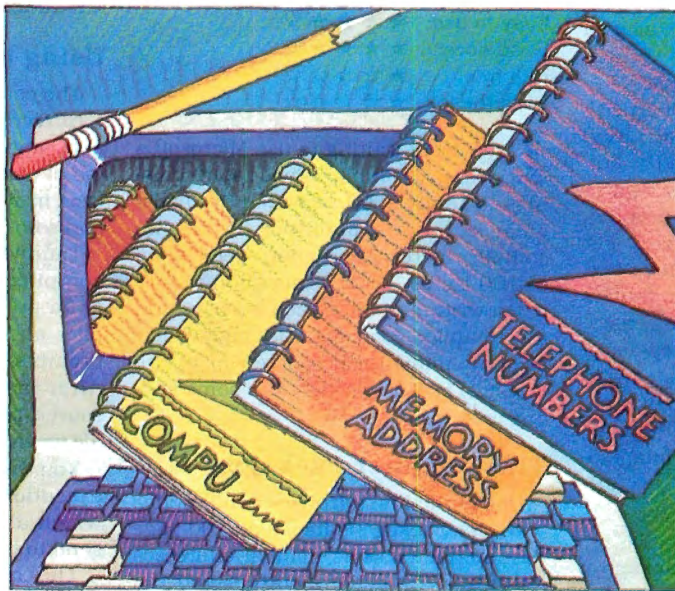

shows you page zero of that data base.

After the header, you can enter information in any format you want. To repeat a set of fields throughout the data base, you duplicate as many pages as you want (up to the limit of 32,767). If your disk can't contain the requested number of pages, Superlog will write as many as possible, then return a "Disk full" message.

Editing Your Notebooks

Once you create a data base, you can edit and manipulate the data in many ways. Superlog offers the same kinds of editing com-

mands as any good word processor. It offers a couple of other unique features as well.

Cut and Paste is a feature unavailable on previous versions of Superlog. It lets you take information from one part of the current data base (or any Superlog data base) and move it to a new position.

If you have a 128K Model 4 with Superlog running in the background, you can move data from your data bases into any foreground program such as a word processor, Basic, an editor/assembler, or into TRSDOS itself.

Exactly how Superlog 4 does all this is a bit complicated. It creates 26 buffers (one for each alphabet key) and lets you assign information from your data bases to any of them. A single buffer, or any combination of buffers, can hold up to 20,000 bytes of information. Once you've marked the desired data and assigned it to a buffer (Cut), you can then move to any foreground program and write that information there (Paste).

This function offers all kinds of possibilities. After weeks of working with Superlog 4, I'm still coming up with new uses for Cut and Paste. You'll probably use Superlog's search function most often. Superlog offers both case-specific and case-indifferent searches. In addition, you can search for multiple words

Once you install Superlog in protected high memory, you can either call it from an applications program or run it in a foreground mode as you would any other applications program. (With a 64K Model 4, you can only use Superlog in the foreground.) You can use Superlog with any other program, as long as the other program doesn't take up both extra 32K memory banks.

To interrupt a working program and call up Superlog, you press the control and both shift keys simultaneously. The Superlog logo appears and asks you for the file (data base) you want. Type in the name of the data base file resident on one of your disk drives, and Superlog takes you immediately to page 1 of that data base. Hit the break key and you're back where you left your foreground program.

Creating Notebooks

Superlog 4 is a sophisticated and somewhat complicated program. KSoft has, in effect, combined a word processor with a data base in a unique way to give you Superlog's notebook features.

To create your data bases, you first supply a name at the file name request prompt. If the data base doesn't already exist, Superlog 4 asks if you want to create it. A "yes" response does so and

and phrases or for unknown characters and variations through a wildcard search function. It's a powerful command that works fast.

Utility Programs

Superlog 4 also comes with a number of utilities. One lets you convert earlier versions of Log or Superlog to Superlog 4 and TRSDOS 6.X format. Another creates a calendar/log file you can call up for any month of the year, even from a foreground program. Superlog also provides a quick-reference help file, as well as a line printer utility that lets you automatically print out the data bases.

Superlog gives you another utility that's really a program in itself, Key/CMD. This program works with the cut-and-paste functions so you can load or append buffers from a disk file or a text string and insert control characters. For instance, this would let you move text from a word processing file into buffers and then paste it into various data bases. Or you could load data into key-designated buffers, perform various editing functions, and rewrite it to the original disk file. Like most Superlog 4 functions, its use is limited only by your imagination and needs.

New Utilities

KSoft recently introduced a package of five utilities to give you even more control over your Superlog files. These five programs let you insert and delete groups of pages at any point in the file, move one page or block of pages to another position in the same or different files, copy pages from one file to another, change the header titles on any group of pages, and renumber Superlog 4 files that you have merged together with the DOS Append command. I tried all these machine-language utilities and found they further enhance Superlog's data base/editing capabilities.

While they offer much additional power to the experienced Superlog 4 user, the key word here is experienced. I would suggest that new Superlog 4 users gain an expertise with the main program before venturing into these powerful utilities.

Conclusion

Superlog 4 fills a need for a full-featured but flexible data base that you don't have to be a programmer to use effectively. The accompanying manual is a model of clarity. It isn't huge (42 pages) but it thoroughly explains every aspect of Superlog 4.

One thing that would help in getting started is a small reference card covering Superlog's extensive command structure. ■

**GW-Basic Compiler:
A Poor Performer**

by John B. Harrell III

★★

MS-GW-Basic Compiler (version 5.05.00) runs on the Tandy 2000 (256K) and requires two disk drives. Tandy/Radio Shack, One Tandy Center, Fort Worth, TX 76102. Radio Shack catalog number 26-5251. \$299.95.

Easy to use: ★★★★★☆

Good docs: ★★★★★☆

Bug free: ★☆☆☆☆

Does the job: ★☆☆☆☆

I have been waiting to use Microsoft's GW-Basic compiler since I started using the Tandy 2000. Now that I've had a go at it, I'm disappointed. While the compiler increases program speed by up to 100 times, it performs abominably when writing to the screen in color, and the compiled color graphics code won't even run under the newer version of MS-DOS (2.11). This product has some serious problems.

The Compiler Package

One of the first surprises you'll notice with this package is its small, 100-page documentation. The manual addresses only the compiler's operation and the specific differences between it and the Basic interpreter. But this isn't a critical drawback since the compiler's commands are so similar to those in Basic that you can use your Basic reference manual as a guide.

The package disk contains the compiler program, two libraries, and a run time support module. Many of the compiled instructions call support routines in the libraries, similar to the way Model I/III Basic makes calls to the ROM.

Because of Microsoft's distribution requirements, the compiler has two libraries. One provides a complete implementation of the compiler language with a link to the run time support module. This module, a separate file on the disk, loads when you execute the compiled program. You can't distribute the run time module without first signing a licensing agreement with Microsoft.

The second library contains all the run time support and creates a stand-alone program that you can distribute as long as you state that you compiled the program using Microsoft's product. However, this library does not entirely support the language. Specifically, it doesn't recognize the Common statement, and it treats the Chain statement as a Run command. Consequently, you can't easily share data in a system of programs when you link them to this library.

AUTO	LLIST
BLOAD	LOAD
BSAVE	MERGE
CONT	NEW
DELETE	RENUM
EDIT	SAVE
ERASE	SYSTEM
LIST	

Figure 1. The GW-Basic compiler doesn't support these Basic commands.

Using the Compiler

The compiler differs from the Basic interpreter in operation, implementation, and language. The manual does a good job of explaining these differences, however. In addition, the compiler fails to support some Basic commands (see Fig. 1).

Tandy recommends that you test the compiler with the demonstration program provided. First, you run the compiler and type in the responses to the prompts, clearly defined in the manual. After that, the compiler compiles the source program and creates an object file as an intermediate output.

You then convert the object file into an execution file using the linkage editor, which also generates a listing you can send to the video, a printer, or a file.

The compiler uses switches to execute special functions during compilation or to alter a normal compiler function (see

The Star Ratings

80 Micro's star ratings reflect our reviewer's impression of a product.

In most cases, the overall rating is an average of the ratings in each of the four specific categories. However, some overall ratings may be higher or lower than this average, depending on the reviewer's subjective opinion.

The stars mean:

- ★★★★★ Superior;
- ★★★★ Excellent;
- ★★★ Good;
- ★★ Fair;
- ★ Poor.

The ratings terms translate as follows:

Easy to use: How easy is it for the new user to use the hardware/software/book?

Good docs: Is the documentation clear and helpful in explaining the product's use and anticipating user problems?

Bug free: Did the reviewer encounter any bugs while using the product?

Does the job: How well does the product do what it was designed for?

DiskCount Data

WHERE
QUALITY PROGRAMS
MEET COMPETITIVE PRICES

2701-C W. 15th • SUITE 612 • PLANO, TX 75075 • (214) 680-8268

All MOD III programs specified in this ad will run on the Model 4 (in the MOD III mode).

WE WILL NOT BE UNDERSOLD!

ELECTRIC WEBSTER WITH CORRECTING FEATURE LIST 149.95 SALE 119.95

HYPHENATION OPTION 38.95
GRAMMAR & STYLE 38.95

WINDOWS ON MOD 4

NOW PRO-TO FROM MISOSYS ALLOWS MODEL 4 USERS TO CREATE AND USE WINDOW OVERLAYS ON THE MOD 4 SCREEN AT THE TOUCH OF A SINGLE KEY. COMES COMPLETE WITH THE WINDOWING UTILITY, ROTATING INDEX FILE, ADDRESS FILE, APPOINTMENT SCHEDULER, CALENDAR, 2 CALCULATORS, CARD FILER, NOTEPAD, PHONE LIST & AUTO DIALER, AND A MINI TERMINAL. A TRULY INCREDIBLE SOFTWARE SET FOR ONLY 49.95
Requires 128K MOD 4 & TRSDOS 6.2

APPLICATIONS

ST-80 III 69.95
Miracle 1000/1200 279.00
Survey Analyst 195.00
Masterdirectory Mod III 29.95
Superdirectory Mod I/III 44.95
Datagraph I/III/4/Max 69.50
Datagraph Pie Chart Option 29.95
The Basic Checkbook I/III 64.95
Mterm I/III/4 59.50
Mterm MSDOS 1000/1200 74.95
Loan Amortization III 29.95
PowerMail Plus I/III/4 124.95
Text-Merge for PowerMail 49.95
PowerMail w/Text-Merge 149.95
The Home Accountant III 62.50
Inventory Control/ICS Pro 148.00
ICS/PRO 1000 & 1200 300.00
BBS-80 Bulletin Board I/III 74.99
BBS-PC MSDOS 1000/1200 225.00
Infocan I/III (Keyword D-Base) 44.95
Ultraterm I/III 44.95
Ultraterm 2.0 w/auto-logon 59.95
TallyMaster 79.95
SPS Statistical Analysis Mod I 150.00
SPS as above for Mod III Inquire

BBS-80 ONLY 74.95

BY MICROSYSTEMS SOFTWARE
A COMPLETE BULLETIN BOARD SYSTEM AT A FRACTION OF THE COST OF SIMILAR SYSTEMS. MOD I OR III

INFOCOM GAMES

PLANETFALL • ENCHANTER •
WINTESS • MOD I or III 34.95
ZORK II • ZORK III • INFIDEL •
SORCERER • MOD I or III 39.95
DEADLINE • STARCROSS •
SUSPENDED • MOD I or III 44.95
THE NEW HITCHHIKERS GUIDE • OR
SEASTALKER • MOD III ONLY 34.95

SCHOOL UTILITY AND EDUCATIONAL

Mostly Basic Educational Tape 14.99
Time Dungeon U.S. History Tape 19.95
Time Dungeon World History Tape 19.95
Test Question Data Bank 49.95
Test Generator/Drill 34.95
Football Scouting 49.95
Basketball Statistics 39.95
Baseball Statistics 39.95
Computer Sat III-1000-1200 79.95

GRAPHIC GAMES AND SIMULATIONS

Voyage of the Valkyrie I/III 29.95
Voyage of the Valkyrie Tape 19.95
Meltdown (Nuclear Powerplant) 19.95
Gamepak-3 (Funface, Match, etc.) 29.95
Pro-Pix NFL Version 29.95
The Wizard Trivia Tester 34.95
Word Challenge 29.95
Concentration 19.95
TRS-80 Opera w/any of the above 10.00

THE HOME ACCOUNTANT ONLY 62.50

By Continental Software
An Outstanding Financial Planner

• Maintains up to 100 budget categories • Keeps track of up to five checkbooks • Prints checks if desired • Prints a personal balance statement, income and expense summary • Prints net worth statement • Provides fast bank reconciliation • Allows the extensions on multiple diskettes • One program handle cash, checkbooks, credit cards and other liabilities and expenses • Unlimited annual transactions, fiscal or calendar year • Transactions may be "split" among different budget categories • Flags transactions for tax purposes • Maintains transaction history • Provides Hi-Res graphics for any category by bar graph
*The program itself does just about everything you'd ask of a personal finance package. -Popular Computing, November 1982.
MOD III

BOOKS, WALL CHARTS & MISC

Inside Super Utility (new issue) 17.95
Super Utility Tech Manual 3.x 13.95
TRS-80 Encyclopedia I/III/4 19.95
TRS-80/Z-80 Assembly Library 31.95
TRS-80 Disk & Other Mysteries 19.95
The Custom TRS-80 & Other Myst 26.95
Microsoft Basic Decoded 26.95
Machine Language Disk I/O 26.95
Basic Disk I/O & Other Myst 26.95
How To Do It On The TRS-80 26.95
TRSDOS 2.3 Decoded & Other Mys 26.95
Basic Faster & Better 26.95
BFB Library Disk I/III 16.95
BFB Demo Disk I/III 16.95
TRSDOS 6/LDOS Programmers
Guide 14.95
Green Screens I/III/4/4P 16.95
Diskettes SSD 10 in Plastic Bx 15.00
Volt Guard Surge Protector 39.95
Profile 3+ Commands Wall Chart* 4.00
Visicalc Commands Wall Chart* 4.00
Superscript Wall Chart* 4.00
Model III Basic Wall Chart* 4.00
Model 4 Basic Wall Chart* 4.00

*Charts not shipped as separate order

WORD PROCESSORS & PRINTER DRIVERS

Lazy Writer I/III/4 119.95
Lazy Font I/III/4 44.95
M-Script I/III/4 53.50
M-Script 1000/1200 MSDOS 74.95
LeScript I/III/4/Max 104.95
LeScript MSDOS-1000-1200 179.95
Clean Slate I/III 49.95
Electric Webster (specify) 119.99
Grammar & Style (specify) 38.95
Hyphenation Opt. (specify) 38.95
PowerDriver-E Epson I/III/4 29.95
PowerDriver-P Prowriter I/III/4 29.95
PowerDriver-S Starwriter I/III/4 29.95
PowerDriver-O Okidata 92 I/III/4 29.95
PowerDriver-FX (FX/RX) I/III/4 29.95
Epson Driver Compiler 29.95
PowerScript for Script II/III/4 34.95
NOTE: If your printer driver is not listed, call, we have more.

\$100 FREE SPECIALS \$200

Order over \$100.00 and select one of the following ABSOLUTELY FREE. Order over \$200.00 and you may select any two items: 80 Micro's 465 page Review Guide • Voyage of the Valkyrie • Meltdown • The Rest of 80 250 page Book • Superkeys Mod III • The Green Window CRT Screen • Varkeep & Screenpacker Plus • Master Directory Mod III • Agri-Calc Feeder Pig Module •

UTILITIES

SuperUtility Plus 3.2 I/III/4 62.50
SuperUtility Plus 4/4P 69.95
J&M Memory Minder I 84.95
J&M Memory Minder III/4 74.95
TextPress I/III (ASCII Comp.) 49.95
Ale Editor/Assembler I/III 38.95
The Toolbox for LDOS 44.95
LC Compiler/EDAS I/III or 4 124.95
ALCOR Editor CP/M TRSDOS
6 MSDOS 49.00
ALCOR Editor I/III 39.00
ALCOR Advanced Development
Pkg 49.00
ALCOR C Complete System 139.00
ALCOR Multi-Basic Compiler 139.00
ALCOR Multi-Processor Assemblr 49.00
AOS Superkeys Key Macros Mod III/35.00
6.2 Plus. (Enhance TRSDOS 6.2) 36.95
The Toolbelt Mod 4 44.95
AOS Utils #1 Varkeep/Scmpkr 49.95
Impakt for Basic I/III 34.95
Pro-Cess Mod 4 24.95
Pro-Create Mod 4 74.95
Pro-Cure Mod 4 39.95
Pro-Duce Mod 4 24.95
Pro-Pads Mod 4 39.95
Pro-LC Mod 4 124.95
Pro-Zcat Mod 4 24.95
Enigma Encryption Utility 34.95
Basic-S Compiler System 34.95
M-ZAL Release 3 Mod I/III 74.95
Zues Editor/Assembler I/III/4 74.95
Master Mechanics Set for LDOS 24.99
E-Basic (specify DOS) 49.95
System Diagnostic I/III/4 89.99
ConvBasic/Cmd I/III/4 29.95
Hypercross/XT TRSDOS
/CP-M/MSDOS 79.95
Hypercross/XT 2.0 99.95
Trashman 32.50
Faster 22.95
RPM 21.50
DSMBLR III I/III 24.95
Accel 3/4 Basic Compiler I/III 94.95
Monitor 5 I/III/4 22.95
Hyperzap Disk Utility I/III/4 49.95
Superdos enhance TRSDOS 1.3 29.95
Z-Basic Compiler 79.50

INSTRUCTIONAL VIDEO TAPES

Specify VHS/BETA 36.99
Profile III Plus, SuperScript, VisiCalc, Newdos-80, Script, TRSDOS 1.3 (Mod III), TRSDOS 6 (M-4), TRSDOS 6 Disk I/O (Mod 4), TRSDOS 1.3 Disk I/O (Mod III), Multidos, Dosplus, LDOS 5.(x), LazyWriter, PFS File, CP/M 2.2 Montezuma (M-4), Multiplan (M-4), PFS File (Mod 4) 36.99 each
Level II Basic or Model III Basic 46.99

GRAPHICS

Powerdraw I/III 34.95
Graphit (Line Graphing) 34.95
AOS Utils. Screenpacker Plus 49.95
PowerDot II I/III Spec. Printer 54.95
Datagraph 69.50
Lazy Font I/III/4 Spec. Printer 44.95

SUPER UTILITY PLUS SALE
VERSION 3.2
By Powersoft
VERSION 3.2 62.50
VERSION 4/4P 69.95

NEW SUPER UTILITY+ VERSION 3.2
Includes Operators Manual and 2nd Backup-Disk
The Book Inside SU+ 3.2
NOW ONLY 17.95
Experience a legend with the program voted as the outstanding utility of 1982 and 1983
MOD I or MOD III Protected Media

OPERATING SYSTEMS

CP/M 2.2 Montezuma Mod 4 169.95
R-Shack HD Driver for CP/M 2.2 30.00
Dosplus 4A With M-ZAL 114.95
Dosplus 3.5 I/III 54.95
Dosplus 3.3 Mod I S or DD 29.95
Multidos 1.7 I/III 79.00
Multidos Mod 4 89.95

TRSDOS-MSDOS CPM

CONVERSION UTILITIES

SUPERCROSS/XT 93.95
SUPERCROSS/XT
W/CONVBASIC 109.95
HYPERCROSS/XT 2.0 99.95
HYPERCROSS/XT 1.8 79.95

THESE UTILITIES ARE A MUST FOR CONVERTING TRSDOS TYPE PROGRAMS TO YOUR MSDOS OR CPM COMPUTER. ALL MENU DRIVEN, THEY DO THE COMPLETE CONVERSION ON YOUR TRS-80. MOD 1 NEEDS DOUBLE DENSITY. THE CONVBASIC IS AVAILABLE SEPARATELY FOR

29.95.
Specify MOD IDD, MOD III, MOD 4

DiskCount Data

214-680-8268

Monday - Friday 10:00 to 8:00 CST
Saturday 10:00 to 5:00 • Closed Wednesdays

Send Cash, Check or Money Order. Please add \$3.00 for UPS Shipping or \$4.00 for US Postage & Insurance. COD's send an additional \$3.00 COD fee. All COD's will require cash or certified upon delivery. Foreign orders are welcome. All shipping charges assumed by purchaser. When ordering by mail, please specify computer model number.

Phone Your Order In Today Or Mail To:
DISKCOUNT DATA, 2701-C WEST 15th, SUITE 612, PLANO, TX 75075



and



Cheerfully Accepted

CONVERT MOD I/III BASIC PROGRAMS and FILES For Use On The IBM PC, TANDY 1000, 1200HD, 2000

Here's time and money saving news for thousands of TRS-80 Mod I and Mod III owners who would love to move up to state-of-the-art hardware! EMSI's conversion package contains utilities to solve both problems facing those who want to upgrade:

PROBLEM 1—HOW DO I GET FROM HERE (Mod I/III) TO THERE (PC)? Do I need to retype everything, buy modems, RS232's, cables and communications software?

ANSWER: None of the above! Use the HYPERCROSS utility included with our package! HYPERCROSS makes the entire disk transfer process very simple—and fast. All the work is done right on your Mod I/III. HYPERCROSS lets you format a diskette readable by all PC's in one drive and copy files directly to it from a Mod I/III diskette. After the transfer, take the PC diskette out of your Mod I/III and put it in your PC. Simple as that! (Mod I's need a doubler).

PROBLEM 2—ONCE I'M THERE, HOW DO I CONVERT MY MOD I/III PROGRAM TO RUN ON A PC?

ANSWER: Use our CNV3TOPC utility to do 95% or more of the conversion for you. It automatically inserts all required spaces between keywords, replaces PRINT@'s (even those with variables) to LOCATE's, adjusts TAB addresses, corrects the exponentiation symbol, replaces the % symbol in USING statements with a backslash, removes down arrows, optionally removes REM's and flags and lists unresolved line numbers. It even allows for Mod I/III screen PEEKs and POKEs.

And, Our thirty page user guide is packed with examples and hints showing how to make any manual program changes required after using CNV3TOPC.

So, there you have it. HYPERCROSS gets you "over there" and CNV3TOPC performs most of the required program changes. Sound too good to be true? Don't take EMSI's word for it. Here are excerpts from two magazine reviews. Note that since publication of these reviews, CONV3TO2000 V1.0 has been enhanced and consolidated with CONV3TOPC V1.0 into one package, namely, CONV3TOPC V2.0

"...Its the best such program I've seen, well worth its higher price over similar programs...The conversion program performed flawlessly. CONV3TO2000 works so well it merits the \$139.95 price tag...."

Mr. Gary Shade, 80 MICRO, May 1985 (4½ stars).

"The documentation is a very strong asset to this package...More software producers should put out documentation like this...NICE JOB BY EMSI!..."

Mr. Lon Andrews, COMPUTER SHOPPER, December 1984.

Customer comments:

"Truly, a Superior Quality Software Package. Count me among your list of satisfied customers."

Waltham, MA

"I would gladly recommend the package to anyone making the change to an IBM type machine."

Wauwatosa, WI

"The fine points of conversion you cover in the manual are excellent."

Salem, OR

"What a time saver. Thanks for a great product."

Denver, CO

"An excellent product. Thank you for the service."

Mapa, CA

"Excellent Software. Outstanding Support."

Wyncote, PA

"Works like a charm! Congratulations."

Odenton, MD

CONV3TOPC V2.0 \$139.95 AVAILABLE WORLDWIDE

AT OVER 2000 RADIO SHACK COMPUTER CENTERS AND PARTICIPATING DEALERS

For your ordering convenience, CONV3TOPC V2.0 is available through Radio Shack's EXPRESS ORDER SYSTEM.

Please order through your local Radio Shack store.

\$20 REBATE! The first 100 CONV3TOPC V2.0 customers who send EMSI a copy of their Radio Shack sales ticket with their Software Registration Card will receive a \$20 cash rebate directly from EMSI.

If it is not possible for you to purchase CONV3TOPC through Radio Shack or another authorized dealer, you may order directly from EMSI by calling TOLL FREE (except NJ)

800-922-0786

(NJ residents 201-879-5982)

EDUCATIONAL MICRO SYSTEMS, INC.
PO Box 471, Chester, New Jersey 07930



EMSI direct order terms: VISA, Mastercard, MO, check or COD. Add \$3.00 shipping/handling. Add \$1.90 for COD. Foreign or first class, add first class postage (package wt. 2½lbs.). NJ residents add 6% sales tax.

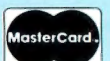

Table 1). For example, one command lets the compiler accept unnumbered Basic programs resulting in a faster final program; another lets you invoke a tracing function so you can follow program logic.

You can also use metacommands in your source code to spell out what you want the compiler to do. Metacommands control the source listing format and provide an Include facility; they're similar to Basic comment statements.

Performance

To its credit, Microsoft's compiler is easy to learn to use; in terms of function and program logic, it's highly compatible with Microsoft's other interpreters.

On the other hand, the performance of the generated code gets the lowest possible evaluation I can give it. In almost every instance, it performs slower than a Basic program when writing text to the video display, especially when writing in color.

I made a series of tests to see how the compiler performed. I tested full-screen graphics performance and text and graphics intermixed, speed of writing full 80-character lines in both color and black and white, and computational performance using the Sieve of Eratosthenes prime number generator.

The compiler produces graphics slowly. In four out of the six graphics tests, the interpreter handled information faster than the compiler (see Table 2).

If you have to print a lot of information to the screen, you're out of luck. The best performance you'll get out of the compiler is that either equal to the interpreter (MS-DOS 2.11) or inferior (MS-DOS 2.00 [see Table 3]).

The compiler handles quantities of data or computations fast. The compiler took only 0.8 seconds to complete the Sieve of Eratosthenes test, while the interpreter took 81 seconds.

In addition to these results, I noted that the generated color graphics code simply would not run under MS-DOS 2.11. Apparently, Microsoft patched the compiler code generators to compensate for the inadequacies in the earlier operating systems.

The compiler exhibits a few other problems. The Clear Screen command doesn't always work. Midway into the program run, the screen turns into a jumble and is totally unusable.

The Color command for selecting inverse video doesn't work like the Basic interpreter's. You select inverse video for only a partial line with the interpreter, but the compiler inverts an entire line of text unless you turn on normal video at the end of the text. Also, I couldn't turn off the cursor in the color mode and it was annoying to watch it slowly jumping all over the screen.

Conclusion

I have used Microsoft's Basic compiler under CP/M and TRSDOS 6.X and haven't had any troubles with them. This review takes issue with its implementation on the Tandy 2000 and, specifically, the screen-handling routines.

Tandy promises an upgraded version of the compiler soon that should fix most of these problems and make it compatible with MS-DOS 2.11.

Unless you compile programs that only work in black and white, I can't recommend this compiler. Its performance is totally unsatisfactory. ■

Category	Switch	Result
Conventions	/4	Compiler uses language convention of older Microsoft compilers.
	/T	Invokes execution conventions of older Microsoft compilers.
Error-handling	/E	Generates a line-number address map.
	/X	Maps each statement to a physical address.
Special switches	/A	Lists equivalent 8086 code for each source code line.
	/D	Generates additional code for debugging and error-handling.
	/N	Minimizes line-numbering constraints.
	/O	Generates references to alternate function library.
	/R	Stores arrays in row-major order.
	/S	Writes string literals to the output file.

Table 1. Special switches the GW-Basic compiler supports.

Program	Interpreter time (seconds)	Compiler time (seconds)
Graphics.BAS bar chart	2.8	8.1
Graphics.BAS curves	12.3	4.9
Graphics.BAS area plot	7.8	18.1
Graphics.BAS pie chart	11.4	23.4
American flag	9.1	10.3
Confederate flag	17.4	35.2

Notes:
 *The significantly faster time for the curves segment of Graphics.BAS is indicative of the compiler's performance in computations and should not be construed as graphics performance.
 *If you compile Graphics.BAS, you will get a run-time error indicating a type mismatch while drawing the area graph. This is caused by the Draw command's limitation.

Table 2. Color graphics performance of the GW-Basic compiler.

Screen mode	MS-DOS 2.00.02		MS-DOS 2.11.01	
	Interpreter (seconds)	Compiler (seconds)	Interpreter (seconds)	Compiler (seconds)
Black & white	1.5	1.7	1.3	1.3
Mode zero				
Color Mode 3	4.3	33.3	2.8	9.5

Notes:
 *This program consisted of a simple For...Next loop that counted from 1 to 24, performed a Locate for each video row, and then wrote a string of 80 characters. Screen mode was zero for the black-and-white tests and three for the color text tests.
 *Even though the times for MS-DOS 02.11.01 show significant improvement, this is attributed to the improved BIOS code and not the compiler. Further, the video screen was instantly set into bright yellow with bright white letters and could not be changed, making the screen virtually unreadable.
 *BASIC 01.02.00 was used under MS-DOS 02.00.02 and BASIC 01.03.00 was used under MS-DOS 02.11.01.

Table 3. Compiler performance writing text to the screen.

Three For the Road

by Mare-Anne Jarvela

If you often use a laptop computer to work out of your briefcase, you'll probably want to print out a document at some point. Portable printers will do the trick—they're small enough to fit in your briefcase and they run on batteries or ac power. You'll find a number of them available, both dot-matrix and letter-quality, in different price ranges and with various features.

I reviewed three portable printers, two thermal dot-matrix and one letter-quality (see the Photo). The thermal printers, the ThinPrint 80 and the Hush 80, are quiet but require special paper. The impact printer, the ThinType 80, works like a standard desktop printer and produces near-letter-quality text, but it's slow and noisy (see Table 4 for a list of specifications).

★★★★

ThinPrint 80. Axonix Corporation, 417 Wakara Way, Salt Lake City, UT 84108. \$339.

Easy to use: ★★★★★☆
 Good docs: ★★★★★☆
 Bug free: ★★★★★☆
 Does the job: ★★★★★☆

★★★★

Hush 80. Ergo Systems Inc., 26254 Eden Landing Road, Hayward, CA 94545. \$159.99.

Easy to use: ★★★★★☆
 Good docs: ★★★★★☆
 Bug free: ★★★★★☆
 Does the job: ★★★★★☆

★★★★

ThinType 80. Axonix Corporation, 417 Wakara Way, Salt Lake City, UT 84108. \$429.

Easy to use: ★★★★★☆
 Good docs: ★★★★★☆
 Bug free: ★★★★★☆
 Does the job: ★★★★★☆

The ThinPrint 80

The ThinPrint 80 is a compact thermal printer. It comes with either a parallel or serial interface and uses 8½-inch roll paper, handily stored inside the printer. A slide switch selects between the two print modes; normal 80 characters per line and compressed 136 characters per line. It also has continuous dot-addressable graphics capability.

This is a true intelligent printer with bidirectional look-ahead printing (after it

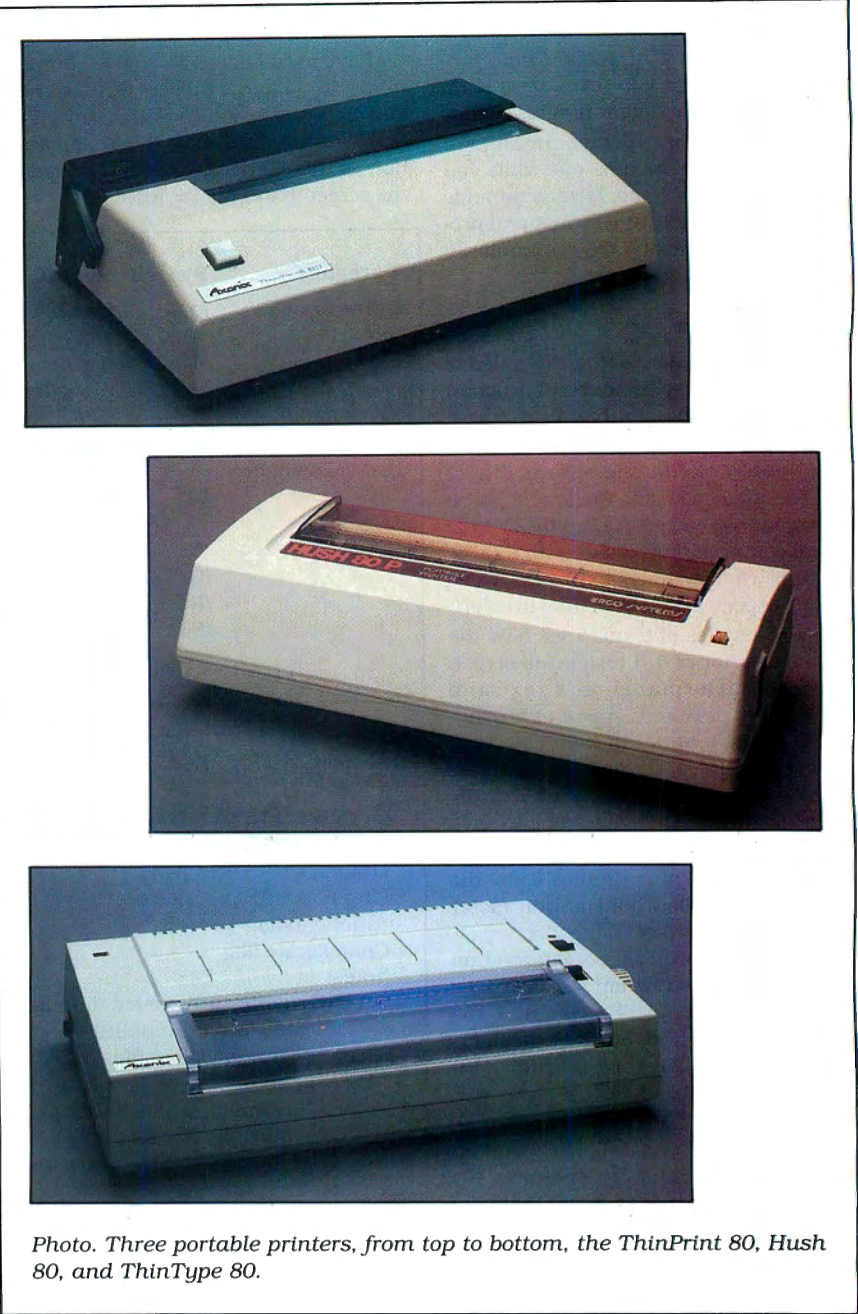

Photo. Three portable printers, from top to bottom, the ThinPrint 80, Hush 80, and ThinType 80.

prints one line left to right, it examines the next line in the buffer and selects the most efficient printing direction). You can adjust the print intensity by turning a small knob at the rear of the printer.

The ThinPrint runs on a built-in rechargeable NiCad battery pack and comes with a recharger. If you don't use the printer for two minutes, its auto shut-off feature kicks in.

You only have to worry about a couple of buttons with the ThinPrint, and you can easily get at the internal DIP switches to set up the printer. The manual is clear on this point and I didn't have problems getting the printer running.

Of the two thermal printers I reviewed,

I liked this one better because it offered features that fit my needs, like intelligent printing and variable print density.

The Hush 80

This thermal dot-matrix printer is fast, quiet, and simple to use. Like the ThinPrint, it stores its 8½-inch-wide roll of thermal paper internally, so you don't have to carry it separately (you can't use single-sheet paper, though).

The Hush 80 comes in three configurations: serial- or parallel-interface and Commodore-compatible. The printer itself weighs only 25 ounces, the paper adds another 11 ounces, and the NiCad weighs 12 ounces. All told, the printer

ONE MEGABYTE MEMORY

For Model 1, 3, and 4

Yes! You can now have 1 million bytes of accessible memory in the model 1, 3, and 4. You can now have a memdisk larger than a double side 80 track drive. Price starts at **\$229** for the first **256K** without the memory. Additional memory can be added at any time in 256K increments. Memory is installed inside the computer. Call or write for more details.

SuperMemdisk — Lets you use the 128K for applications and still use the extra memory for a RAMDISK. 192K for the 256K version or 386K for the 512K version . . . \$49.95.

Other Products

5 MHz Speed-up for Model 4 (\$69.00) Model 4P (\$79.00)	
10 Meg internal hard drive for Tandy 1000	\$599
20 Meg internal hard drive for Tandy 1000	\$999
TEAC 1/2 height, DS 40 track drive	\$115
TEAC 1/2 height, DS 80 track drive	\$135
OKIDATA 92p	\$384
OKIDATA 84 step 2	\$675

Qume, Juki, Panasonic, Epson, and other printers available

Write for complete catalog of products.

ALPHA TECHNOLOGY INC.

A1A Computer Division
1902 Highway A1A
Indian Harbour Beach FL 32937
(305) 773-2956 11 am-6 pm Mon-Sat
Dealer inquiries invited

Master Card, Visa, Amex, and COD's accepted
Above prices reflect cash discount

Circle 133 on Reader Service card.

TANDY 1000 384K SYSTEM

THE AFFORDABLE PC COMPATIBLE!

SYSTEM INCLUDES:

- TANDY 1000 COMPUTER
- EXTRA 256K OF MEMORY
- TANDY VM-2 MONITOR
- TANDY SECOND DRIVE
- BOX OF (10) DISKETTES
- HEAD CLEANING KIT

LIST \$2,146

CDA - \$1,529

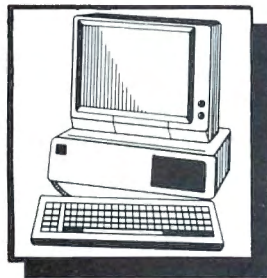

**INCLUDES
DESKMATE
SOFTWARE**

Major Credit Cards Accepted!
WE ALSO STOCK • TANDY 1200 HD
• TANDY 2000 • TANDY 6000 • TANDY 200
& MODEL 4 • CALL FOR PRICE QUOTE!



ORDERING INFORMATION AND TERMS:
Mail to: CDA COMPUTER SALES
31 Marshall Hill Rd., West Milford, NJ 07480
Include address and phone number. Shipping, handling and insurance are additional. Add 2% UPS Ground (\$3.50 minimum) UPS Blue 6% (\$5.00 minimum)
NO C.O.D. Cashiers checks, moneyorders and credit cards ship immediately. Personal and company checks allow 15 days.

ORDER 9am - 7pm EST Monday - Friday, Saturday 10-4

OUR REFERENCES: We have been selling computers since 1977 and in computer Mail Order since 1980. Our bank is: First Fidelity, West Milford, N.J. D&B listed.
ORDERS 800-526-5313 INQUIRIES & IN NJ 201-728-8080

AD No. 1006-8

New from PowerSOFT™ Now Copy files From TRS-80 to PC/MS DOS or CPM and BACK with SuperCROSS/XT!

Did you just get a new Model 1000, 1200, or PC? How about CP/M? Just get that? Now with SuperCROSS/XT you can COPY your files TO or FROM 70 different DOS formats direct disk to disk! You can also FORMAT an alien disk, display the DIRectory or KILL files. Fully MENU driven with plenty of on-line HELP available! Very easy to operate in today's computer environment, especially for non-programmers.

GREAT new features make SuperCROSS/XT the transfer system of choice:

***"FOREIGN-TO-FOREIGN"** file transfers for the first time!! No longer a two step operation! Setup two different DOS formats in two different drives ala SU+ for COPYing files back and forth.

***MASS FILE TRANSFERS!** Now features a new TAG feature which allows you to "mark" any number of files for COPYing or KILLing!

***CONFIGURE** for the DOS you COPY from most, for faster automatic startup time!

SKIP command for reading or writing a 40 track disk in an 80 track drive!

PowerSOFT presents the **state-of-the-art-file transfer program** for use on the TRS-80! SuperCROSS/XT is designed to allow you to move DATA and program files freely between your own TRS-80 and DOS formats of other computers. You can now do this with SuperCROSS/XT and your existing hardware, eliminating modems, wires, and terminal program transfers. SuperCROSS/XT runs as a /CMD file under your TRS-80 operating system and will allow you to COPY files back and forth between different operating systems. You may format on a foreign disk in your TRS-80 and COPY files to it that can be read by, for example a Model 1000, a KAYPRO or an IBM PC. Note that machine language programs, although transferable, will NOT run due to the difference in microprocessor chips used in the different machines.

You can copy BASIC, PASCAL, FORTRAN, C, or other high level language programs, and run them with little modification, unless they make extensive use of graphics, or have machine language calls. CNVBASIC/CMD, available separately, will make most of the syntax and spacing changes required for converting Model I/III BASIC programs for use on other systems. Data files, spreadsheet files, and text files can also be usefully moved between machines. If you use or have the same Visicalc or Multiplan on the TRS-80, you can use the same files on other machines! These spreadsheet files are directly convertible to 123 and other calc-type programs. Of course, the combinations and possibilities are endless, and the flexibility is ALL there with SuperCROSS/XT!

DOS Formats Supported MS-DOS variations include MS-DOS 1.0, 2.0/2.1 single or double-sided (IBM and most compatibles), and Tandy 2000. CP/M variations include most well known single and double-sided formats including Tandy's 3.0+, Montezuma Micro 2.2 (all versions), Holmes and 60 others including: ALTOS, CROMEMCO, DEC, EAGLE, EPSON, HP 125, CP/M 86, KAYPRO, LNW-80, LOBO MAX-80, MORROW, NEC, OSBORNE, OTRONA, SANYO, SUPERBRAIN, TELETEK, TELEVIDEO, TRS-80, LIFEBOAT/1, OMICRON/1, HOLMES/3, HURRICANE COMPACTOR/3, SHUFFLEBOARD/3, XEROX, ZENITH-HEATH, and 8" standard CP/M. *Of course double-sided drives are required for reading DS disks. Use SS for transfers, if needed.

If you use another computer besides your TRS-80 at work or home—you need SuperCROSS/XT so call or write, but order today! Only \$99.95. Check, VISA/Mastercard or COD accepted. Please add \$3 for shipping/handling (\$2 additional for COD). Foreign orders please add \$10 for AIRMAIL.

SuperCROSS/XT\$99.95
(Please specify Model I-DD/III, 4/4P, or MAX-80 version)
CNVBASIC/CMD (CONVERT BASIC for Mod I/III/4)\$29.95
Convert: I/III BASIC programs for use on MS-DOS, CP/M, or Mod 4!
If ordered WITH SuperCROSS get BOTH programs
for only..... \$119.95



PowerSOFT Products
17060 Dallas Parkway, Suite 114
Dallas, TX 75248
(214) 733-4475

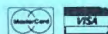

All trademarks are the properties of the companies represented.

weighs no more than 3 pounds.

The Hush 80 prints at a fast 80 characters per second, and does it so quietly you could talk on the phone next to it. It supports 129 different characters, including international characters. You can choose from three printing modes: the standard 80 characters per line, expanded mode with 40 characters per line, and compressed mode with 160 characters per line. You can also print dot-addressable graphics.

The printer comes with an interface cable, a power cord with a 9-volt transformer, and a roll of paper. You can buy either a non-battery version Hush 80 or one with built-in NiCads for \$40 more.

The printer's on/off switch is on the left-hand side of the unit, with the power cord socket inconveniently located underneath. The line-feed button is on the top right-hand side of the printer.

At first, I couldn't find the Hush 80's DIP switches to adjust line feed, and the manual didn't mention them. I called the company and they helped me find the switches (hidden under the printer's casing.) Ergo Systems has since moved the switches to underneath the front panel and the manual now explains how to set them.

Hush 80's features and price (half the price of the ThinPrint) make it a worthwhile buy.

The ThinType 80

If you need to print letter-quality documents on the road, the ThinType 80 is a good choice. Its printout is like that of a typewriter and it uses regular, single-sheet paper. But you pay for the quality: The ThinType is noticeably slower, heavier, and louder than the thermal printers.

The ThinType comes with internal rechargeable batteries, an internal ac adapter/charger, and a cable. It prints about 10 pages per charge and recharges in two hours. To help save battery time, the printer shuts off automatically if you don't use it within two minutes. You can order an external battery pack (\$79.95) and a dc car adapter (\$69.95), too.

The ThinType has a spin-wheel print head comprising five smaller wheels. The ink comes in an ink roll that's easy to replace and prints over 2 million characters.

The ThinType has two sets of power switches and indicator lamps. The ac switch is on the left, the dc on the right. The auto line-feed switch is located below the ac power switch. The printer cable goes into the back of the printer.

I had some problems getting the line feed to work correctly but after some trial and error, I managed to get it right. The ThinType 80's price and noise will make some people balk, but its print quality might override its drawbacks. ■

A Window On the CP/M World

by John B. Harrell III

★★★★★

Monte's Window runs on the Model 4/4P (128K) and requires Montezuma Micro CP/M 2.2 version 2.2X. Montezuma Micro, CP/M Support Division, P.O. Box 32027, Dallas, TX 75232. \$49.

Easy to use: ★★★★★

Good docs: ★★★★★

Bug free: ★★★★★

Does the job: ★★★★★

Monte's Window is a valuable addition to any Model 4/4P owner with 128K who uses Montezuma Micro's CP/M. Like Borland International's famous SideKick package, Monte's Window gives you access to a single-screen note pad, calendar, calculator, index card file, and CP/M system functions at any time, even when you're working in another application.

Inside the Window

You activate Monte's Window by pressing both shift keys at once. You can call up a window any time, except with a CP/M system function active.

When you invoke a window, Monte's Window saves the current contents of the video screen, including the cursor location and screen information, in reverse video. When you exit a window (by pressing the control-C), the program restores your applications screen and your previous cursor location.

The note pad displays a single screen of data that you can edit, print out, or move to or from a disk. One notable option lets you copy your current screen to the note pad so you can manipulate it with Notepad commands.

Notepad's editor is a simple one, lacking many of the features of a full-fledged text processor, like an insert capability and search and replace. You can, however, clear the entire note pad and select reverse or normal video modes for it.

The text file Notepad creates measures 24 lines by 80 characters and terminates lines with end-of-line markers. If you call up a text file you created with another program and use it with Notepad, Monte's Window may wreak havoc with its format.

The calendar accurately displays any month in the years from 1700 to 2200. You can move forward or backward in time by month or year using commands displayed on-screen. You can also copy the calendar to the note pad to print it out.

Before Monte's Window displays a month, it scans the index card file for date-specific notations (meetings, appoint-

Continued on p. 113

Specification	ThinPrint 80	Hush 80	ThinType 80
Price	\$339	\$159.99	\$429
Dimensions (in.):			
Width	11.5	11.6	11.7
Depth	7.5	5.5	7.8
Height	2.5	2.8	2.5
Weight (lbs.)*	4.25	3	7.5
Roll Paper	Yes	Yes	No
Single Sheet	No	No	Yes
Speed (cps)	40	80	15
Battery	Yes	Optional	Yes
AC	Internal	9 volt	Internal
Serial	Yes	Yes	Yes
Parallel	Yes	Yes	Yes
Self-test	Yes	Yes	No
Print type	Dot-matrix	Dot-matrix	Impact
Characters supported	95 ASCII	129 ASCII	96 ASCII
International characters	No	Yes	No
Characters/line	80	80	80
Character modes:			
Condensed	Yes	Yes	No
Expanded	No	Yes	No
Emphasized	No	No	No
Inversed	No	Yes	No
Underline	No	No	No
Tab	No	Yes	No
Bit graphic	Yes	Yes	No

*Weight includes batteries

Table 4. Portable printer specifications.

Circle 216 on Reader Service card.

TRS-80+ MOD I, III, COCO, T199/4a
TIMEX 1000, OSBORNE, others

GOLD PLUG - 80

Eliminate disk reboots and data loss due to oxidized contacts at the card edge connectors.

GOLD PLUG 80 solders to the board edge connector. Use your existing cables. (if gold plated)

GOLD PLUG 80 Mod I (6)	\$44.95	\$54.95
Keyboard/EI (mod I)	15.95	18.95
Individual connectors	7.95	9.95
COCO Disk Module (2)	16.95	18.95
Ground tab extensions	INCL	1.00
Disk Drives (all R.S.)	7.95	9.95
Gold Disk Cable 2 Drive		29.95
Four Drive Cable		39.95
GOLD PLUG 80 Mod III (6)		54.95
Internal 2 Drive Cable		29.95
Mod III Expansion port		10.95
USA shipping \$1.45		Can/Mex \$4.
Foreign \$7.		TEXAS 5% TAX

SPECIAL PRICES

COCO MODULE INSTALLATION AVAILABLE

Ask your favorite dealer or order direct



E.A.P. CO.
P.O. BOX 14



ORDER TODAY!

KELLER, TEXAS 76248

(817) 498-4242

MC/VISA

+ trademark Tandy Corp

Circle 488 on Reader Service card.

FULL SCREEN EDITOR

TRS-80 MODEL 1-2-3-4-4P-12

- * Speeds Programming
- * Corrects Errors Easily
- * Copy Unprotected
- * Insert-Delete-Modify Characters/Words/Lines
- * Convert Program Lines to Immediate Commands
- * Duplicate Program Lines
- * Become More Productive
- * Word Processor Type Commands
- * Repair Your Programs

With a few simple keystrokes, you position the cursor anywhere on the screen and key in your desired changes simply and quickly. The somewhat slow BASIC edit feature is no longer required. Go directly to the problem and make your changes. Grab a problem program line and make it an immediate statement that you entered for debugging and make it part of your program. Eliminate excessive keystrokes and save time. (Requires 2 drives to install)

Becomes part of your Radio Shack® BASIC
1-800-334-9612 U.S.-Alaska-Hawaii
1-800-922-5904 in South Carolina

MICRO-LINK

P.O. Box 2666
Sumter, SC 29151

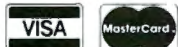

Visa-Mastercard-COD Due to our low prices, all sales are final

Only **\$33.50**
Plus \$5.00 Shipping/Handling
for COD Add \$3.00
Shipments by UPS Blue Label

Circle 206 on Reader Service card.

Introducing Super Utility 4/4P.

The indispensable first-aid kit for TRS-80 users only from PowerSoft.

Even the healthiest computer needs occasional "doctoring". And that's precisely what Super Utility 4/4P is for. To help you handle routine check-ups, take care of minor emergencies and perform major surgery with relative ease.

So effective it mends everything but a broken heart.

The latest generation of PowerSoft's highly-rated program contains over 60 different utilities. So you can examine file locations. Reformat without erasing data. Test or manipulate memory. Save valuable data and disks. Revive dead files. And much, much more.

So easy you can perform near miracles in no time.

Version Four enhancements make Super Utility 4/4P easier, faster and more efficient than ever. It boots and loads 50% faster. Utilizes 64K for faster file

copies and backups. It's configurable with most Model I/III/4 operating systems for fast, easy transfer of files. And introduces three function keys, including a user-definable key, for easy, single-stroke operations.

So economical you can't afford to be without it.

At only \$79.95, SU4/4P can be yours. And that includes both a master and backup disk, 148 page manual, binder and full support. The more you know about your TRS-80, the more you'll want SU4/4P. The less you know about your TRS-80, the more you'll need SU4/4P.

So place your order today by calling or writing:

PowerSoft Products
17060 Dallas Parkway
Suite 114
Dallas, Texas 75248
214/733-4475

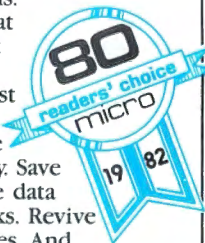

Coming Soon For MS-DOS

POWERSOFT

VISA and MasterCard welcome.

SU 4/4P \$79.95

SU + 3.2 Model I/III/(4) \$79.95

Please add \$3.00 S/H in USA & Canada;

\$10.00 Foreign (airmail)

SUMMER ROMANCE

Learning to Love Model 4 Basic

When Tandy introduced the Model 4, many users who cut their teeth on Level II and Model III ROM Basic doubted that the 4's RAM-based Basic was anything but a giant step backward. You had to separate key words with spaces, you had no single-key editing commands, and you had fewer than 30K of free memory with which to work.

But first impressions aren't always good ones. After using the 4P, TRSDOS 6.X.X, and Model 4 Basic for over a year, I can say without reservation that this Basic is second to no other 8-bit version.

Let me explain what I've learned. I'll start by discussing how to get around Basic's limited memory, then look at Model 4 Basic's new and enhanced commands and functions.

Gimme Some Space, Man

Model 4 Basic lets you use variable names of up to 40 significant characters, and the names can include embedded key words. Thus, GRANDTOTAL, COMPANY.NAME\$, and COMPANY.ADDR\$ are all legitimate (the periods in the last two are undocumented but valid characters).

You pay a price for this versatility—you have to use spaces to delimit your key words. This, along with the longer variable names, means that you use more memory. But you'll find that in a year (or even in a week) your code will be easier to modify and maintain. For example, a line like this one requires no Remark statements to explain its logic:

```
10 IF SALES > BONUS.MIN THEN  
   BONUS.AMT = SALES*.05
```

If you write a long program, or one that needs lots of memory for variable storage, you might have to break it up into modules. Fortunately, this is easy, since Model 4 Basic includes complete and simple program chaining facilities. You can pass any or all variables and file buffer descriptions to another program, and use the Merge option to integrate code with a program in memory.

Program Listing 1 uses Model 4 Basic's chaining capabilities in a menu sequencing program, one that can pass control and preset constants or open files to either

a submenu or a processing program. Program Listing 2 shows a portion of a sample processing module, ENDDAY/MRG.

Lines 1000-59999 in the MAINMENU segment define the number of menu selections, the menu page title, and the selections proper. You would model subsequent submenus after these lines. The user function FNINV\$(X\$), defined in line 20, adds the leading and trailing video control codes needed for inverse video to its argument X\$. A While...Wend loop validates the selection, after which line 150 chains in the proper file (menu or process) for the selected function.

You can follow the implementation of the Chain command in line 150 as follows. First, the program specifies the Merge option. Basic reads program lines contained in the ASCII file MRG.PRG\$(n) from disk, encodes them, and then inserts them into the source code already in memory. This insertion follows the same rules as those used when you're writing a program: Basic will insert a line that does not exist and overwrites a line that does exist. The program starts with line 1000 of MRG.PRG\$(n), and passes all variables to the new program.

The Delete command specifies that Basic should delete lines 1000-59999 in the original program before it merges the new code. Both the start and end lines used as arguments for Delete must exist or you'll get an error; thus, the REM statement in line 59999 is only a place holder.

The ENDDAY/MRG module shows how Basic would break the menu loop (line 1000) for actual data processing. Another command (Chain or, at this point, Run) would return to the main menu.

The Erase command (line 30 in Listing 1) completely removes an array from memory as though you had never dimensioned it. Consider a sort routine that builds an index array from a direct- (new word for "random-") access file, sorts it, and then writes the array to an index file. You no longer need the index array left in memory, which can now limit the size of any new arrays and precipitate more frequent and time-consuming garbage collection. The simple command ERASE TMP.SORT\$ eliminates these nasty pos-

sibilities. One caveat—any array you want erased must exist or you'll get an error. You can use the Common statement in lieu of the All parameter in the Chain command. Basic passes only variables specified as its arguments to a chained program. This requires you to plan more carefully, but it does use memory most efficiently.

Some programmers are confused about the Common statement's function in a program to which they're chaining another. Common's only action is to pass variables to the chained program. Common in a chained program specifies variables you want to pass to subsequent code, and you don't need it to receive the first program's variables.

Quiz Time

Now that you know all about program chaining, here's a challenge for you. Using Alan Smith's Model 4 machine-language sort routine from the March 1985 *80 Micro* ("A Sort Story," p. 70), write a chainable sort routine that receives the sort array from your program and passes the sorted array back to the calling program (or on to another for further processing).

Here are some hints. In the calling program, include these lines:

```
COMMON SORT4ARRAY$( ), ARRAY.SIZE%,  
   NEXT.PROG$.START.LINE%  
CHAIN "SORT4/BAS"
```

In the sort program, include these lines:

```
COMMON SORT4ARRAY$( ), ARRAY.SIZE%  
CHAIN NEXT.PROG$.START.LINE%
```

Notice that I specified the execution line for NEXT.PROG\$ as a variable (START.LINE%). You can do this, too, but the program must declare the variable used as an integer value, either with DEFINT or by



System Requirements

Model 4/4P
64K RAM
Basic



If you haven't yet warmed up to TRSDOS 6.X.X Basic, read on. Clifford I. Knight shows you how it offers improvements in program structure and execution speed over Model I/III Basic.

Program Listing 1. MAINMENU/BAS.

```
1 ' *** MAINMENU/BAS ***
10 CLS:DEFINT A-Z:DIM MRG.PRG$(1)
20 DEF FNINV$(X$)=CHR$(16)+X$+CHR$(17)
30 CLS:ERASE MRG.PRG$:RESTORE 59000
40 READ MAX.SLCT:DIM MRG.PRG$(MAX.SLCT)
50 READ TITLE$:PRINT TAB(40-LEN(TITLE$)/2);TITLE$
60 PRINT:PRINT:CTR=0
70 WHILE CTR<MAX.SLCT
80   CTR=CTR+1:READ MRG.PRG$(CTR)
90   PRINT SP$(20);FNINV$(STR$(CTR)+" ");"- ";
100  READ SELCT$:PRINT SELCT$:PRINT
110 WEND:PRINT@(22,10),"Enter Selection... ";:I=0
120 WHILE I<1 OR I>MAX.SLCT
130   I=VAL(INPUT$(1))
140 WEND:CLS
150 CHAIN MERGE MRG.PRG$(I),1000,ALL,DELETE 1000-59999
999 ' *** MAIN/MRG *** - save in ASCII format
1000 GOTO 20 ' entry for a menu module
59000 DATA 3,"MAIN MENU - XYZ Company"
59010 DATA "OEMENU/MRG","Order Entry System Menu"
59020 DATA "INVMNU/MRG","Inventory Control System Menu"
59030 DATA "ENDDAY/MRG","Start End of Day Sequence"
59999 REM
```

End

Program Listing 2. ENDDAY/MRG.

```
1 ' *** ENDDAY/MRG *** - save in ASCII
1000 ' end of day code goes here
2000 '...
50000 CHAIN MERGE "MAIN/MRG",1000,ALL,DELETE 1000-59999
59999 REM
```

End

Program Listing 3. Input routine without While...Wend.

```
10 I$=INPUT$(1)
20 IF I$=CHR$(13) THEN GOTO ??? (70)
30 IF I$<" " THEN GOTO 10
40 IN.LIN$=IN.LIN$+I$
50 PRINT I$;
60 GOTO 10
70 '... code continues here
```

End

Program Listing 4. Input routine with While...Wend.

```
10 WHILE I$<>CHR$(13)
20   I$=INPUT$(1)
30   WHILE I$>=""
40     IN.LIN$=IN.LIN$+I$
50     PRINT I$;
60     I$=""
70   WEND
80 WEND:I$=""
90 '... code continues here
```

End

using the type specifier "%." Unfortunately, you can't pass deletion line numbers as variables.

I'll leave the discussion of chaining with these additional points. First, contrary to what the Model 4 manual implies, when you're not using the merge option, you don't need to save the program you've chained in ASCII format.

Second, when you use the merge option, you can't necessarily preserve user-defined functions. Basic stores and references user functions at their original location in the source code. Should the delete option remove the line containing the function definition, or if a merged program overwrites the definition line, that function ceases to exist and you'll get an error condition.

While...Wend

Listing 1 uses While...Wend, a structured programming technique long available in other languages. It doesn't do anything you can't do in Model III Basic, but it lets you write code that's easier to maintain.

Examine the input routines in Program Listings 3 and 4. In the first example, I had to complete the GOTO in line 20 after writing the code. Using While...Wend in Listing 4, I didn't. When you use a While...Wend loop, something must alter the value of the control variable (I\$ in Listing 4), or the program won't break the loop. Line 60 does this by assigning the null string to I\$. In line 80, Basic again clears I\$ so that the program can reenter the routine. You can nest While...Wend loops (one inside the other as shown in Listing 4) to any number of levels.

I used Basic's new input function, INPUT\$, in Listings 3 and 4. It replaces INKEY\$; for example, the Model III code in Listing 3 might be 10 I\$=INKEY\$:IF I\$="" THEN 10. The syntax is INPUT\$(n,b), where "n" is the number of characters (no more, no less) from a file assigned to buffer "b" or from the keyboard if you don't specify a buffer. Model 4 Basic doesn't echo keyboard input to the screen.

It Takes Coordination

Microsoft altered the Model 4's PRINT@ function so you can specify screen locations as row and column coordinates; the syntax is PRINT@(r,c). This is an easier way than that Model III Basic uses to set up display positions.

You can still specify PRINT@ locations as an offset from the start of video memory, which has an advantage: You can store calculated or premapped cursor locations in single-integer variables (with a value of zero to 1919) instead of two-integer variables needed to store row/column designators.

New also is the ROW(x) function,

Powerful Programming Tools At Bargain Prices

C compiler

for the model 1 or 3 using TRSDOS, LDOS, NEWDOS, DOSPLUS, or MULTIDOS; includes full screen text editor and advanced development package

List Price ~~\$250.00~~
Sale Price \$89.95

Multi-Basic compiler

for the model 1 or 3, or 4 using TRSDOS, LDOS, NEWDOS, DOSPLUS, or MULTIDOS; includes full screen text editor and advanced development package

List Price ~~\$250.00~~
Sale Price \$89.95

This is a full K & R standard implementation of C that includes a Unix compatible function library. The package also includes a 450 page manual with a tutorial on using the C language. If you've been wanting to learn C, this is the package you need.

Features Include

char	8 bits	initializers
short	8 bits	typedef
int	16 bits	static
unsigned	16 bits	auto
long	32 bits	extern
float	32 bits	struct/bit fields
double	64 bits	union

Execution speed on the Model 3 for 10 iterations of the prime number program published in Byte, Jan 83, page 284.

LC Compiler	105 secs.
Alcor C	78 secs.

Special Bonus

Buy one version for \$89.95 and get the version for the other model for only \$21.

Multi-Basic is a TRS-80 BASIC compatible compiler. The Model 4 version supports everything in the TRSDOS 6 BASIC interpreter except the COMMON statement. The same support is provided in the Model 1 and 3 versions so programs are portable. The CMD statement is the only statement from the Model 1 and 3 BASIC interpreters that is not supported.

Multi-Basic also supports advanced language features like multi-line procedures and functions, recursion, and dynamic string management (no long pauses for garbage collection).

Execution speed on the model 3 for 10 iterations of the prime number program published in Byte, Jan 83, page 286.

BASIC Interpreter	4570 secs.
Multi-Basic	89 secs.

Special Bonus

Buy one version for \$89.95 and get versions for the other two models for only \$21 each.

Sale Price Extended Through October 31

C Compiler

Circle version(s)	Model
One version (\$89.95)	1 3
Both versions (\$110.95)	_____
Add 6% sales tax (Texas only)	_____
Shipping \$6 USA/\$28 foreign)	_____
Total	_____



1132 Commerce Systems
Richardson, TX 75081
(214) 238-8554

Name _____
Street _____
City _____
State _____
Zip _____
Country _____
Phone _____

Also available for CP/M & MSDOS
\$89.95 each

MC Visa Money Order Check COD
Card # _____ exp _____

Multi-Basic Compiler

Circle version(s)	Model
One version (\$89.95)	1 3 4
Two versions (\$110.95)	_____
Three versions (\$131.95)	_____
Add 6% sales tax (Texas only)	_____
Shipping \$6 USA/\$28 foreign)	_____
Total	_____

Multi-Basic is a trademark of Alcor Systems
TRS-80 is a registered trademark of Tandy Corp.
MSDOS is a trademark of MicroSoft
CP/M is a trademark of Digital Research
Unix is a trademark of Bell Laboratories
LC is a trademark of Mimosys

Circle 215 on Reader Service card.

Program Listing 5. Error-handling routine.

```
10 WARN1$="<ENTER>":WARN2$=SPACE$(7)
60000 PRINT@(23,5),"INVALID Entry!!! - Hit ";
60010 CSR=ROW(X)*80+POS(X)-1
60020 PRINT "<ENTER> to continue... ";
60030 WHILE INKEY$<>CHR$(13)
60040 WHILE TMR<>VAL(RIGHT$(TIME$,1))
60050 TMR=VAL(RIGHT$(TIME$,1))
60060 SWAP WARN1$,WARN2$
60070 PRINT@CSR,WARN1$;
60080 SOUND 3,0
60090 WEND
60100 WEND:RETURN
```

End

Program Listing 6. Clock display and CAPS lock toggle.

```
10 CLS:GOSUB 60000
20 CAP.PTR%=10*256+2^5
22 'flags+10, bit 5 = CAPS lock
30 CLK.PTR%=21*256+2^4
32 'flags+21, bit 4 = Clock ON/OFF
40 DEF FNTGL%(X%)=PEEK(FLAGS%+X%56) XOR (X% MOD 256)
100 INPUT "Type your name ";N$
110 POKE (FLAGS%+CLK.PTR%56),FNTGL%(CLK.PTR%)
120 PRINT "Clock ON"
130 POKE (FLAGS%+CAP.PTR%56),FNTGL%(CAP.PTR%)
140 INPUT "Type it again ";N$
150 POKE (FLAGS%+CLK.PTR%56),FNTGL%(CLK.PTR%)
200 PRINT "Clock OFF":END
60000 FOR J%=1 TO 6:READ USER%(J%):NEXT
60010 FLAGS%=0:GET.FLG%=VARPTR(USER%(1))
60020 CALL GET.FLG%(FLAGS%):RETURN
60100 DATA 16101,-4251,-6659,-7743,9073,-13968
```

End

which returns the current cursor row number (zero to 23). You can use Row with the familiar POS(x) to get the cursor's row/column coordinates. A slight problem with POS is that it returns a value of 1-80; PRINT@ positions are specified as zero to 79.

Many Basic commands (such as Row and POS) require a dummy argument; for example, the "x" in the above examples. This satisfies Basic's function interpretation routine's syntax requirements. They are place-holders, preventing the parsing routine from labeling a function with no argument as a syntax error.

Swap (SWAP v1,v2) is a useful new command that, as its name implies, interchanges the values of its arguments. The parameters must be variables, not constants, and must be identical types. An obvious use of Swap would be in a Basic sort routine. You can also use it to toggle a string or numeric variable between two possible values, as you'll see in an example to follow.

Internal string manipulation has been greatly streamlined in the new Basic through the use of dynamic string memory allocation and improved assignment

techniques. No longer do you need to reserve string storage space with the Clear statement, which is now modified to set Basic's top-of-memory pointer. You can use a second Clear argument to set Basic's stack size. You would need this only in extraordinary program situations. Clear alone resets all variables as it does in Model III Basic.

Microsoft modified FRE(x%) to return the amount of free memory, the same as MEM does. With dynamic string space allocation, its old Model III function becomes meaningless in Model 4 Basic. The Model 4 manual states that you can have a dummy parameter of any type and that executing this function forces garbage collection and returns the amount of free memory. In fact, garbage collection occurs only if you use a string variable as the dummy.

Frequent use of FRE can minimize the delays of garbage collection by reducing the number of orphaned strings at each purge. You'll notice the FRE delay least if you use it immediately after displaying a screen of data, or just after an input prompt when the user is busy reading or formulating a response.

Restore(n) has been modified to let you reuse the data in a specific line of code. This is an improvement over previous Basics, in which Restore reestablishes access to all data.

Sound (SOUND t,d) is a new Model 4 Basic command. The function generates a tone of frequency "t" and duration "d" via the 4's internal speaker. This is a tone more suited to games and as an alarm than for music.

The Model 4 interpreter offers a new output command, WRITE# (WRITE# b,data. . .), to output to the file associated with buffer "b" the data contained in a data list, properly delimited with commas and quotes as sequential files require. If you don't specify "#" and buffer number "b," Write sends data to the screen, a useful debugging aid, since you'll see even a string of spaces (or leading/trailing spaces).

Microsoft replaced the Model III TIME\$ function with DATE\$ and TIME\$. You thus no longer need the cumbersome LEFT\$(TIME\$.8) and RIGHT\$(TIME\$.8) commands to separate the date and time.

Other "convenience" commands include Option Base and SPACE\$. The first lets you specify either subscript zero or 1 to describe the first element of an array. By specifying a base option of 1, the element subscripts of an array will correspond to the record numbers of a direct-access disk file.

SPACE\$ (SPACE\$(n)) builds a string of "n" spaces in the same manner as STRING\$(n,32). A related command, SPC(n), is similar to TAB(n) except that it moves the print position to the current column plus "n" spaces. Tab moves to absolute column "n."

You can convert numeric values to hexadecimal (base 16) or octal (base 8) string representations with HEX\$(n) and OCT\$(n). If you program in Assembly language, you'll appreciate the HEX\$ function; otherwise, you might never need it.

Program Listing 5 is a simple error-message-handling routine using some of the new commands and functions discussed.

The program enters the subroutine at line 60000. The subroutine prints the first portion of the error message and then calculates the cursor position for the blinking message (line 60010). By repeatedly setting the variable TMR equal to the seconds counter of TIME\$, the While..Wend loop toggles WARN1\$ and WARN2\$ to blink the message once per second. SOUND 3,0 in line 60080 alerts the operator.

What Else Is New?

Model 4 Basic incorporates a new method of interfacing to machine-language routines. Unlike the USRn statement of the Model III, the Call statement (CALL a(v1,v2,v3, . . .)) lets you pass more

TRS-80™ - Tandy - IBM Personal Computer - MS-DOS - CP/M

SMALL BUSINESS ACCOUNTING WITH PAYROLL \$79.95

Based on the **Dome Bookkeeping Record #612**, this program handles income, expenditures, and payroll for a small business. Complete ledgers are maintained for income and expenses on a monthly basis. The program computes monthly, through last month, and year-to-date summaries. The payroll section can handle up to 99 employees. Paychecks with up to six deductions can be entered whenever desired (weekly, monthly, etc.). The program can print both payroll and expense checks. Quarterly and year-to-date payroll summaries can be computed for one or all employees.

HOME BUDGET and CHECKBOOK ANALYST \$59.95

A complete checkbook program together with budgeting, income and expense analysis, comparisons, and projections. First, it is a complete checking program: enter and print checks, enter deposits, and compute your current checking balance. The program also handles non-check expenses and income. It computes monthly and year-to-date income and expense summaries, and projections for the year based on data through a known month. Monthly expenses can be compared to a pre-established budget.

MAILING LIST \$69.95

Maintain mailing lists of up to as many names as you can fit on a standard diskette (1,250 for TRSDOS, 2,500 for MS-DOS). Add, change, delete, or find names. Sort according to data in **any** field. Print labels in 1, 2, 3, or 4 columns with adjustable tabs.

TRS-80™ Models 1, 3, and 4

TYPITALL Word Processor \$129.95 TYPITALL with Spelling Checker \$179.95

The most powerful word processor for the TRS-80s. TYPITALL is upward compatible with SCRIPSIT — it reads your old SCRIPSIT files and uses the formatting and cursor movement commands you are already familiar with. But it is a completely new word processor with so many advanced features that we can't even mention all of them here. You'll wonder why other word processors don't have some of these features.

- Send **any** control or graphic/special character to the printer.
- Print the formatted text **on the screen** before going to the printer.
- Send formatted text to a **disk file** for later printing.
- **Merge** data from a file during printing. Names, addresses, and other text can be inserted during printing. No need for a separate program for "mail merge" capabilities!
- Print while editing (spooling).
- Assign **any sequence of keystrokes** to a **single** control key.
- Call up to 16 **help screens** at any time.
- **Move cursor** forwards or backwards by character, word, line, or page.
- **Reenter** the program with **all text intact** if you **accidentally exit** without saving the text.
- Optional spelling checker comes with 29,500 word dictionary. Verify a 3,500 word document in **less than two minutes**.
- True Model 4 (80 x 24 display, TRSDOS 6) and Model I/III versions.

SYSTEM DIAGNOSTIC \$99.95

Is your computer working correctly? **Are you sure?** Find out for certain with System Diagnostic, which has complete tests for every component of your TRS-80 Model 1, 3, or 4.

ROM: checksum test. **RAM:** three tests including every location and data value. **Video display:** character generator, video RAM, video signal. **Keyboard:** every key contact tested. **Line printer:** character tests with adjustable platen length. **Cassette recorder:** read, write, verify data. **Disk drives:** disk controller, drive select, track seek, read sectors, formatting, read/write/verify data with or without erasing, disk drive timer, disk head cleaner. Single or double density, 1-99 tracks. **RS-232-C interface:** connector fault, data transmission, framing, data loop, baud rate generator.

SMART TERMINAL \$74.95

The **intelligent** communication program. Use your TRS-80 to communicate with other computers, bulletin boards, information services, time sharing, or for data transmission. **Memory buffer** holds data to be transmitted or received. **Automatic transmission** of data from buffer. **Automatic storage** of incoming data. **Character translations.** Data files compatible with word processors and BASIC programs. True BREAK key.

TRS-80™ MODEL III ASSEMBLY LANGUAGE book \$16.95

A complete course on assembly language, written for the **beginner**. Contents include: the Z80 instruction set; TRS-80™ Model III ROM and RAM; Using the Editor/Assembler; Reading, printing and moving data; arithmetic operations; floating-point and BCD numbers; logical and bit operations; cassette input and output; USR subroutines in BASIC; RS-232-C data communication; disk input and output; the TRSDOS 1.3 disk operating system.

ASSEMBLY LANGUAGE MONITOR #5 \$22.95

TRS-80™ MODEL III ASSEMBLY LANGUAGE book and MONITOR #5 \$29.95

A comprehensive machine language monitor and debugging program. **Display** memory in ASCII or hexadecimal format. **Disassemble** memory to show machine language commands. **Move and compare** blocks. **Search** through memory for different values. **Modify** memory in different ways. **Relocate** machine language programs. **Read and write** cassette tapes of machine language programs. **Unload** programs in low RAM on disk. **Print** output optionally on video display or line printer. **Save and load** disk files. **Input and output of disk sectors**, bypassing disk operating system. **Complete debugging package**, including setting and displaying registers, single stepping through machine instructions, setting breakpoints, and executing machine language operations.

Circle 175 on Reader Service card.

HOWE SOFTWARE

14 Lexington Road
New City, NY 10956

Developing software for TRS-80™
computers since 1979.

24-Hour TOLL-FREE Order Number:

Outside California call:

(800) 428-7825, ext. 169

Inside California call:

(800) 428-7824, ext. 169

Visa, Master Card, or COD orders only.

For information call: (914) 634-1821

Add \$3.00 shipping and handling.
(\$6.00 for Canada, Alaska, Hawaii,
\$17.00 air mail postage overseas.)
New York residents add sales tax.

*TRS-80 is a trademark of Tandy Corp.

than one parameter to (and from) user routines. When the program enters your Assembly-language subroutine at address "a," the HL and DE registers will hold the VARPTR addresses of variables used as parameters 1 and 2 in the Call statement. If you specified only three parameters, BC holds the VARPTR value for parameter 3. If you're passing more than three values, BC points to a table of VARPTRs for the remaining parameters. If your machine-language routine saves these pointers, you can pass data back to Basic by stuffing the proper information into the pointers.

An example of multiple value passing could easily take all the space I have here, but I'll use Call in an example later to receive an integer value.

The old Renumber command Name now renames files from Basic. The RENUM command rennumbers Basic source code. All line references in GOTOS and GOSUBs are renumbered, but you can't renumber a block of lines in the middle of a program.

"WIDTH [LPRINT] n" lets you set the line width of either the video display or printer output (if you use the LPRINT option). I can't see a use for the latter; the forms filter does this and more. Nor can I see much use for its video function. But it's there, so I thought I'd mention it.

Another new command, Wait, suspends program execution until Basic inputs a specific bit pattern from whichever one of the Z80's 256 input ports you specify. This is a convenience command; it does nothing that you can't do with a While...Wend loop and the INP(n) function. I took a quick look at the Model 4's port assignments and can't see any use for this in a standard system.

LPOS(x) returns the column number coinciding with where Basic expects your printer will print the next character. I say "expects," because Basic has counted

The ERRS\$ function returns a string containing the error number and a descriptive message.

each character sent to the printer since the last carriage return to arrive at this value. Many characters output to a printer directly control print head movement, but Basic counts each as a single character. Keep this in mind if you use this function.

You won't find the Level II and Model III CMD functions in Model 4 Basic, but you can duplicate most of them fairly easily. I've already mentioned the sort routine published in *80 Micro* to take the place of CMD"O". CMD"X", the cross reference function, is not available and sorely missed by some programmers. (*80 Micro* has a Model 4 cross-reference program slated for publication later this year.—Eds.)

Model 4 Basic has a function, ERRS\$, that is similar to CMD"E". It returns a string containing the error number and a descriptive message. TRSDOS's error messages are often more informative than Basic's; for instance, should you attempt to access a drive without a disk, Basic gives you a "Bad file name" error, while the DOS gives you "Drive not ready."

You can duplicate CMD"R" and CMD"T"'s control of the clock display with SYSTEM "TIME(CLOCK=Y)". Unfortunately, the DOS Time command displays the time and a carriage return at the last cursor position, marring the display.

The routine in Program Listing 6 overcomes this problem by loading and executing a 12-byte machine-language subroutine that puts the address of the DOS's system flag's storage area into the variable FLAGS%. From this base address, the 4 calculates two pointers, one to the keyboard flag byte (CAP.PTR%) and another to the display status byte (CLK.PTR%). By POKEing values obtained from a user function FNTGL%, you can toggle both the clock display and the CAPS lock on or off.

This routine also introduces two new arithmetic operators and one new logical operator. MOD provides the modulus function; X MOD Y returns the remainder of X divided by Y.

The backslash character provides an integer division function; that is, X\Y yields the integer portion of the quotient.

In line 20, the integer variable CAP.PTR% has the offset from FLAGS% assigned to the high byte (10*256), and the bit number of the CAPS flag assigned to its low byte. The user function FNTGL% decodes this integer variable into the offset and bit number using the integer division and MOD operators.

The exclusive OR logical (XOR), a new logical operator, also appears in the user function, and toggles the flag bit.

Writing about Model 4 Basic's graphics commands is simple—there aren't any. Model 4 Basic doesn't include the Model III's Set, Reset, and Point commands. However, the Model 4 character generator can produce the same (modified somewhat for the new screen format) 64 graphics characters as the earlier machines, so by carefully building strings with CHR\$(n) you can create graphics displays.

You can add Set, Reset, and Point with Mark Goodwin's machine-language subroutines published in the April 1984 issue of *80 Micro* ("Restored Art," p. 157) or

Circle 350 on Reader Service card.

® SASSE FREEDOM FILE FILING SYSTEM

SASSE the first full application program designed around the Model III that takes full advantage of the windowing technique. **SASSE** has word-processing & multi-tasking capabilities. It enables the operator to (1) sort, print, edit and search different files simultaneously; (2) call the HELP or OPERATION MANUAL in the midst of an operation; (3) stack 8 windows of various information at one time. \$75.00 plus \$3.25 P&H

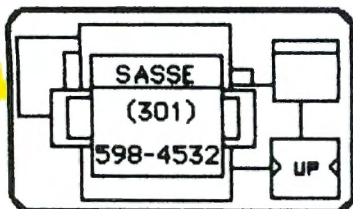

MEMOIR Model III

Executive Free Form Note Processor

1. Windows
2. Disk files
3. Metric chart
4. Manual on disk
5. Area code index
6. Timed Memos

Just \$39.95 plus \$2.25 P&H

THIS OR THAT utility—Now you can run two of your application programs at the same time. \$20.00 + \$1.25 P&H
WINDOWPAD utility—The utility that started it all! Still just \$20.00 + \$1.25 P&H. Call or Write **EN FLEUR CORP.** 2494 SUN VALLEY CIRCLE, SILVER SPRING MD 20906

with Alan Smith's Basic subroutine in this issue ("Upgraded Graphics," p. 76). If you're really into graphics, look up "Clear-Cut Trends" in the April 1985 issue (p. 40). It contains programs for the optional high-resolution video board with 640- by 240-pixel resolution.

Model 4 Basic includes many internal improvements to reduce source code length and increase execution speed. One such technique is a better way of storing numeric constants. When you type in a program, the computer converts numeric constants to the same packed format in which it stores variables as it encodes each line. To see what I mean, type in the following:

```
10 A = 123456
20 B = 1234567890123456
```

Now list it. See the "!" and "#" characters that the interpreter appended to your constants? A memory dump of this code shows that Basic stores the first constant in 5-byte single-precision format (1 byte less than the same code saved in ASCII) and that it stores the second value as an 8-byte double-precision value (saving 8 bytes). Since Basic doesn't have to decode constants each time the executing program meets one, the program runs faster.

Conclusions

Model 4 Basic is a big improvement over the earlier versions. The chain capability, in conjunction with Erase and the improved Restore statement, means that your programs' lengths are limited only by disk space. While...Wend removes the confusion of GOTO statements, and new techniques of dynamic string allocation and constant storage improve overall execution speed.

If you're an old Model I or III programmer who hasn't explored Model 4 Basic yet, get cracking—you'll soon give up your old ways. ■

Related Articles

Goodwin, Mark D. "Redevelopment Program." April 1984, p. 96. Program to convert Model III Basic programs to the Model 4.

Goodwin, Mark D. "Restored Art." April 1984, p. 157. Program to add Set, Reset, and Point to Model 4 Basic.

Graebner, Bruce A. and Jeffrey P. "Clear-Cut Trends." April 1985, p. 40. Business graphs for the III/4 hi-res board.

Smith, Alan D. "A Sort Story." March 1985, p. 70. A fast string sort for the Model 4.

Address correspondence to Clifford I. Knight, 6 Janebar Circle, P.O. Box 253, Manomet, MA 02345.



Circle 249 on Reader Service card.

Type fast!



Hunt and peck is fine for chickens but you can **FasType™**.

- *FasType™* is the fun and easy way to learn to type.
- *FasType™* teaches the TRS-80 III/4/4P keyboard.
- *FasType™* is machine language fast.
- *FasType™* is teacher written, classroom proven.
- *FasType™* for Tandy 1000, August 1, 1985.

\$39.95/disk plus \$1.50 shipping. Arizona residents add 5%. Specify model. Schools ask about our network version.

FasType™



Press 'A' Software
Box 364
Jerome, AZ 86331
602-634-2688

Circle 266 on Reader Service card.

T/Maker®

Integrated Software

Word Processing
Spread Sheet Analysis
Relational Data Base Management
Spelling Checker
Bar Chart Graphics
Data Encryption

Available for:

IBM PC, Tandy 1000, 1200, 2000
Requires 128K, Retail \$450

Kaypro, Epson, Montezuma CP/M
Requires 64K, Retail \$450

NEW! Model 4 4P (TRSDOS 6.2)
Requires 64K, Retail \$299

T/Maker Company
2115 Landings Drive
Mountain View, CA 94043
415/962-0195

Info World quote from "Review Responses," V6N51. © 1985, Info World.
Reprinted by permission. All rights reserved. © 1985, T/Maker Company.

Now Available for
MODEL 4/4P (64K)
and
TANDY 1000 (128K)



Infoworld
Report Card
T/Maker

"T/Maker is excellent."

— Don Crabb, 12/17/84



Sifting Through GW-Basic

by Dave Rowell

**A programmer's
guide to the nuances
of Model 1000 Basic.**

I've been experimenting with the Tandy 1000 version of GW-Basic, and I'm pleased with the capabilities it offers. In particular, its event-trapping, graphics, and sound statements represent improvements over earlier versions of GW-Basic, even the Tandy 2000's. I'll discuss some

of the new features in detail, using short programs to illustrate what you can do with them.

Besides these welcome enhancements, you'll find subtle functional changes in several familiar Basic statements, changes that can cause you frustration if

you're used to Model III/4 Basic. I'll point out a few. GW-Basic also lacks some Model III features you'll miss, like CMD"" and your favorite system POKES.

Some Pitfalls

Before I get to the new stuff, I'll discuss some snags you might encounter if you're an old Model III Basic programmer. Like Model 4 Basic, GW requires that you accompany each If statement with a Then statement except with GOTOs. And you can't have Next statements in conditional phrases, like this:

```
90 REM ** The Model III way
100 IF A > 550 THEN FL = 1 : NEXT ELSE
    FL = 0
110 PRINT "The line above causes a syntax error in GW."
120 NEXT
```

Instead, replace Next with a GOTO pointing to the one Next statement allowed each For:

```
90 REM ** The GW equivalent
100 IF A > 550 THEN FL = 1 : GOTO 120 ELSE
    FL = 0
110 PRINT "One and only one Next for each For"
120 NEXT
```

Model III Basic executes any For...Next loop at least once. Model 4 Basic and GW-Basic skip over a loop if the counter will never enter the specified range, as is the case here:

```
100 FOR I = 1 TO 5 STEP -1
110 PRINT "This will print once on a Model III."
120 PRINT "but never on a Model 4 or Tandy 1000."
130 NEXT
```

Such a loop could result from using variables within the For range specifiers or in the Step statement. If you do use variables in the loop, and need it to execute at least once, examine your logic carefully.

If you nest For...Next loops (or GOSUBs) to the nth degree, your program might abort because it has run out of stack space. Fortunately, you can increase available stack space from the default (768 bytes or 1/8 of usable memory) with the Clear statement. Clear doesn't allocate string space on the Model 1000 as it does on the Model III; that's done dynamically. Clear also provides options for you to set aside space in high memory for machine-language subroutines or increase video storage space for the more greedy graphics modes.

Misunderstanding the Input statement can really cause problems. In Model III Basic, you can assign a default value to a variable, then let the program user change that value with an Input statement or leave it as is by pressing only the enter key:

```
100 X = 100 : PRINT "Correction factor is 100."
110 INPUT "Type in new value, or press enter to leave unchanged.": X
```

Do this on an MS-DOS machine and you'll get erroneous results in the calculations that follow. GW-Basic maliciously nulls variables if you press only the enter key in response to an Input prompt.

Here's a GW-Basic version of the Model III input routine above:

```
100 X = 100 : PRINT "Correction factor is 100."
110 INPUT "Type in new value, or press enter to leave unchanged.": X$
120 IF VAL(X$) = 0 AND X$ <> "0" AND X$ <> "" THEN GOTO 110
130 IF X$ <> "" THEN X = VAL(X$)
```

Using a string instead of a numeric Input statement in line 110 lets the program determine if you input a zero or just pressed the enter key. Line 120 makes sure you've entered a number.

Random Rules

Microsoft tweaked GW's RND() function to make it predictable and repeatable, if you desire. If its argument is zero, RND repeats the pseudo-random number it generated previously. Any other argument, or no argument, produces a number between zero and 1 (the case in Model III Basic with an argument of zero).

The Model III RND() function can produce a random number between 1 and integer X if you use X as its argument. It's not that easy in GW-Basic:

```
10 P = INT(RND * X) + 1 'pseudo-random number between 1 and X
```

If you write programs for several Tandy machines, the following algorithm gives you equivalent results on the Models I, III, 4, 1000, and 2000:

```
10 P = INT(RND(0.1) * X) + 1
```

The Models I and III truncate RND's argument to zero, the 4 rounds it, and MS-DOS machines accept it as nonzero, so all Basics produce a "random" number between 1 and X.

The Model III Random function reseeds the random number generator so that a program produces a different set of pseudo-random numbers each time you run it. The Randomize function is GW's replacement for Random, and it takes an argument, as in RANDOMIZE 232. To help in program testing, this function repeatedly produces the same series of random numbers for a given argument. To make a program generate a different set of numbers each time you run it, use the Timer function as an argument. Timer returns the number of seconds since midnight on the system clock:

```
10 RANDOMIZE TIMER 'Reseed with Timer
```

All Clear

MS-DOS machines have a 15-character type-ahead keyboard buffer. This is usually a convenience, but not when your program requires paging a series of text screens by key presses. A few misplaced keystrokes, or pressing a key long enough to start key repeat before the paging prompt appears, sends your information flashing past faster than you can speed-read.

You can avoid the problem by clearing the keyboard buffer before the input routine that starts each text page. Use an INKEY\$ loop with 15 repetitions, or better

yet, INKEY\$ in a While...Wend loop. Here are examples of both methods:

```
100 FOR I = 1 TO 15 : X$ = INKEY$ : NEXT I
'Clear buffer
110 PRINT "Press any key to see next page."
120 IF INKEY$ = "" THEN GOTO 120 'Wait for key press
130 REM ** Show next text page
```

```
100 WHILE INKEY$ <> "" : WEND 'Clear buffer
110 PRINT "Press key for next page."
120 WHILE INKEY$ = "" : WEND 'Wait for key press
130 REM ** Show next screen
```

On the IBM PC, you can POKe directly into the circular keyboard buffer, setting the input queue's tail and head to the same location. The DOS input routine then reads the buffer as empty, a trick that also works on highly IBM PC-compatible machines like the Tandy 1000. Replace line 100 in the above routine with:

```
100 DEF SEG = 0 'Set to bottom 64K segment
101 POKe 1050, PEEK(1052) 'Input queue head equals tail
102 DEF SEG 'Restore Basic memory segment
```

MS-DOS machines are faster than Z80-based micros; Basic on the 1000 runs about four times faster than on a Model III. If you use For...Next loops as time delay routines, you'll have to adjust your counter values accordingly.

More accurate than a For...Next Loop, and easier to set, is a subroutine containing GW-Basic's Timer function:

```
1010 REM ** Time delay subroutine: set
    TM = number of seconds before calling.
1020 TM1 = TIMER : TM2 = TIMER 'Initialize subroutine timers
1030 WHILE TM > TM2 - TM1 'Test elapsed time
1040 TM2 = TIMER 'Get current time
1050 WEND 'End While loop
1060 RETURN
```

The subroutine stores the initial time when it enters the loop in TM1, then keeps sampling the present time until the number of seconds passed in variable TM has elapsed.

Miscellany

Several minor differences between Model III and GW-Basic are worth mentioning before I move on to GW's new features. The exponentiation sign is the caret symbol (shift-6), not the up arrow (printed as the left bracket).

Cassette commands no longer exist. GW functions that convert their arguments to integers round them to the nearest integer, like Model 4 Basic; they don't truncate them as does Model III Basic. And three functions, CINT, Fix, and INT, change real numbers to integer values. I have to look them up each time I use one. You'd better, too.

If you've done any GW-Basic programming at all, you know you must surround key words by spaces: DEF USR is two words. This increases program size. If you have a 128K 1000, believe it or not, you may find your programming space al-

Program Listing 1. Example of the On Timer event trap.

```

10 ON TIMER(111) GOSUB 1000      'Every five seconds when active
.
.
100 TIMER ON                    'Activate timer event trapping
110 WHILE Inkey$ <> "" : WEND    'Clear keyboard buffer
120 PRINT "Calculations are complete. Check totals before continuing."
130 PRINT "Press Enter to stop beeping and continue."
140 WHILE Inkey$ = "" : WEND
150 TIMER OFF                    'Deactivate timer event trapping
160 REM ** Whatever comes next
.
500 END
.
1000 REM ** Beeper subroutine
1010 BEEP                        '1/4 second 800 Hz tone 1020
RETURN

```

End

Program Listing 2. Hyperspace graphics program.

```

10 CLS : KEY ON : KEY OFF      'Turn off 25th line key display
20 CLEAR ,,,327681            'Modes 4--6 take more RAM
30 SCREEN 5                    'Medium resolution, 16 colors
40 DEFINT A-N
50 DIM A(32)                  'To hold palette assignments
60 FOR I = 1 TO 32 : A(I) = (I MOD 15) + 1 : NEXT I
70 LINE (0,100)-(320,100),1 : LINE (160,0)-(160,200),1
80 PRESET (160,100)           'Resets to background (black)
90 FOR I = 10 TO 220 STEP 10
100 CLR = (I/10) MOD 14 + 1
110 CIRCLE (160,100),I,CLR,,,,6 'an oval centered on screen
120 NEXT I
130 FOR I = 15 TO 1 STEP-1
140 A1 = A(I):A(I)=0           'keep background black
150 PALETTE USING A(I)        'A() must be an integer array
160 A(I) = A1                  'restore A(I)
170 NEXT I
180 GOTO 130 'Loop until Break

```

End

Program Listing 3. Using the Draw statement with a string argument.

```

100 CLS : KEY ON : KEY OFF
110 CLEAR ,,,327681           '32K of your RAM for graphics
120 SCREEN 5                  'Hi-res, 4 colors
130 ON KEY(1) GOSUB 510
140 ON KEY(2) GOSUB 520
150 ON KEY(3) GOSUB 530
160 FOR I = 1 TO 3 : KEY(I) ON : NEXT I
170 ON KEY(11) GOSUB 540
180 ON KEY(12) GOSUB 550
190 ON KEY(13) GOSUB 560
200 ON KEY(14) GOSUB 570
210 ON KEY(15) GOSUB 580
220 ON KEY(16) GOSUB 590
230 FOR I = 11 TO 16 : KEY(I) ON : NEXT I
240 D$ = "M320,100"          'Move to center screen
250 X = POINT(0) : Y = POINT(1) 'Get location of last point
260 IF X < 0 THEN D$ = "R1"   'Reverse direction if off-screen
270 IF X > 639 THEN D$ = "L1"
280 IF Y < 0 THEN D$ = "D1"
290 IF Y > 190 THEN D$ = "U1" 'Stay above 25th line
300 DR$ = CL$ + D$           'Combine color and direction
310 DRAW DR$
320 GOTO 250
500 REM ** Subroutines
510 CL$ = "C1" : RETURN      'Set color
520 CL$ = "C2" : RETURN
530 CL$ = "C3" : RETURN
540 CL$ : RETURN
550 GOSUB 540 : SCREEN 0,0,0 : WIDTH 80 : END 'Cls then reset screen
560 D$ = "U1" : RETURN      'Set direction to move one point
570 D$ = "L1" : RETURN
580 D$ = "R1" : RETURN
590 D$ = "D1" : RETURN

```

End

Program Listing 4. Spiral graphics program using the Draw statement.

```

10 REM ** Draw purple spiral
20 CLS : CLEAR ,,,327681 : SCREEN 6
30 B = .1 : C = 1.01
40 B = B*C+1 : A = B MOD 360
50 IF B > 6000 THEN END
60 DR$ = "C2ULTA" + STR$(A)
70 DRAW DR$
80 GOTO 40

```

End

ready limited. Graphics memory takes at least 16K and Basic is in RAM, too. You can break up large programs and string the pieces together with the Chain and Common statements, but you should get a memory upgrade if you can afford it.

On Event-Trapping

Event-trapping is one of GW-Basic's fortes. In addition to the On Error trap found in Models III and 4 Basics, GW has traps for RS-232 input, light pen activity, joystick and mouse button presses, special key input, the condition of the music buffer, and a countdown timer.

Event-trapping lets you set up interrupt procedures for unpredictable events, then forget about them while your program does other things. When one of these events occurs, the program stops where it is, executes a subroutine set up for that event, and returns to what it was doing, without losing stride.

You can turn on or off, or temporarily suspend, trapping for a particular event. The Stop parameter suspends trapping during critical procedures, but keeps track of events and takes appropriate action when trapping resumes. Program Listing 1 is a demonstration of the On Timer event trap; I'll give examples of other event traps later on.

The syntax of event traps is fairly uniform. First you specify a subroutine with the On statement, as in line 10 of Listing 1. Trapping starts when an On statement executes (Line 100) and ends with an Off statement (Line 150).

The Timer trap's argument, 111 in this case, specifies a time period during which you have the event trap active. According to the manual, it should be 111 seconds, but I found that 111 produces a five-second period between traps. I programmed the On Timer() trap as a beeper. When it's active, the program drops to the Timer subroutine every five seconds, where it executes the Beep command. In the example, the beeper notifies you that a long processing task is finished and needs attention.

Display It Again, Sam

Screen display is where the TRSDOS Basic programmer will feel least at home. You can't POKE graphics characters to the screen easily with GW-Basic, but you shouldn't have to. Here's where you'll find the greatest number of new commands, commands that plot points and display text, change colors (up to 16) or graphics resolution (three levels), draw simple or complex shapes, even define the screen window's dimensions.

It's daunting to take all this in at first; however the examples that follow show not only how to use these features, but why you'd want to. The listings are short, and I suggest typing them in.

Hyperspace, Program Listing 2, is an entertainment program from the cheap

Continued on p. 53

FOR QUALITY SUPPLIES AND ACCESSORIES, VISIT YOUR NEARBY RADIO SHACK COMPUTER CENTER

CERTIFIED MEDIA AND STORAGE UNITS

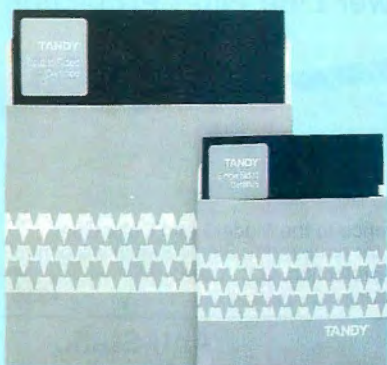

Stock Up on Error-Free Floppy Diskettes

Radio Shack's floppy diskettes are double coated with an advanced ferric oxide blend to provide maximum lubrication and resistance to diffusion. Buy in quantity and save—and store your

valuable data safely. These are double-density, soft-sectored diskettes, and are unformatted. Don't be caught short—stock up now! Buy all you need today, and remember to always have plenty of quality Radio Shack diskettes on hand.

Single-Sided				
Size	Tracks	Quantity	Cat. No.	Price
5 1/4"	40	1	26-305	3.49
5 1/4"	40	3	26-405	8.99
5 1/4"	40	10	26-406	24.95
8"	77	3	26-4904	12.95
8"	77	10	26-4906	34.95

Double-Sided				
Size	Tracks	Quantity	Cat. No.	Price
5 1/4"	40	3	26-411	9.95
5 1/4"	40	10	26-412	27.95
5 1/4"	80	3	26-409	13.95
8"	80	10	26-410	39.95
8"	77	3	26-4961	16.95
8"	77	10	26-4960	44.95



Certified Cassette Tapes for Data Storage

Our certified cassettes deliver error-free performance for tape-based computer storage systems. Each quality data storage tape is free from defects and includes a hinged plastic box for protection.

Deluxe C-20 Cassette Tape. "Reel-to-reel" design in a clear shell. 26-308 3.79
C-20 Tape. 26-301 2.79
C-10 Tape. 26-302 1.89

Quantity	Deluxe C-20 (Each)	C-20 (Each)	C-10 (Each)
1-11	3.79	2.79	1.89
12-23	3.39	2.49	1.69
24-47	2.99	2.19	1.49
48-Up	2.69	1.99	1.39



Diskette Library Boxes for Convenient Storage

- A 8" Library.** Holds ten. 26-4952 . . . 5.95
- B 5 1/4" Library.** Holds ten. 26-1452 . . 4.95
- C 5 1/4" Travel Tote.** Holds five diskettes. 26-1348 2.95



Protect Your Disks With a Sturdy File Box

- A 5 1/4" Economy File Box.** Holds 50. With five adjustable dividers. 26-1362 14.95
- 8" File Box.** Holds 50. 26-4953 . . . 24.95
- B 5 1/4" Locking File Box.** Holds 50. With four adjustable dividers. 26-1353 24.95



Disk Filing Solutions

- A Wallet File.** Holds ten 5 1/4" diskettes. 26-1366 7.95
- B Universal Data Binder.** 3-ring binder for disk envelopes. 26-1310 5.95
- C 5 1/4" Envelopes.** Holds 2. Pkg. of 10. 26-510 7.95
- D 8" Envelopes.** Holds 1. Pkg. of 10. 26-4907 7.95

WE HAVE EVERYTHING YOU NEED FOR COMPUTER CARE AND CONVENIENCE

Standby Power System

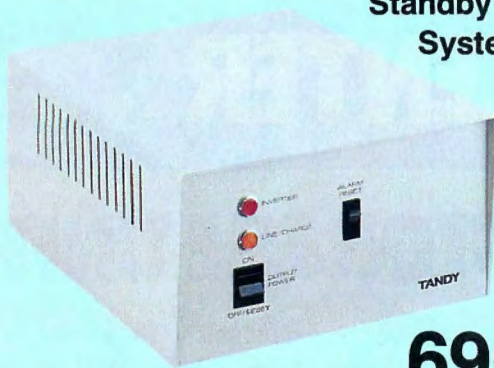

695⁰⁰

BPS 400. Protect your home or office computer with a backup power supply. The BPS 400 provides more than 10 minutes of full power operation (400 VA) after an electrical failure. During normal operation, it works as a power line filter. Not for equipment or drives using AC motors: Model II, Disk Expansion Bay, or 8-Meg Hard Disk Drive. 6 x 10³/₄ x 12¹/₂". U.L. listed. 26-1189 695.00

Automatic Power Strip



69⁹⁵

SW-301. Activates peripherals when you turn on your computer (not for Model I or Color Computer). Features 2-stage surge protection. U.L. listed. 26-1429 69.95

Power Line Filter Protection

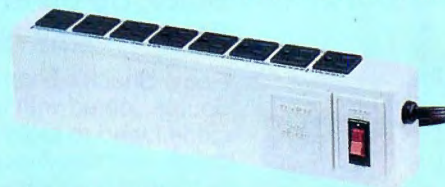

49⁹⁵

Limits AC power line interference to the Model I and Color Computer or any sensitive computer equipment. Single switch will control eight outlets. Includes surge protection. U.L. listed. 26-1244 49.95

Head Cleaner Kit



Cleans drive heads safely and easily. With disk, solution and instructions.
5 1/4" Drive Kit. 26-408 7.95
8" Drive Kit. 26-4957 8.95

Anti-Static Mat



89⁹⁵

Chair not included

Guard against data loss. Continuously drains static charges that can damage your computer. Durable vinyl. 45 x 53". 26-1351 89.95

Anti-Static Spray



5⁹⁵

Use on equipment, screen or carpet. Helps eliminate problem-causing static electricity. Long-lasting and safe. 26-515 5.95



Typing Easel

Adjustable (8³/₄" to 13⁷/₈") T-bar and friction pad keeps books and other material open and in place. Folding legs for easy storage. 73-2003 17.95



Screen Cleaner

Reduce eye strain. Keep your screen bright and easy to read. Helps prevent dirt build-up on screen. With 50 pre-moistened wipes and lint-free cloth. 26-1318 6.95

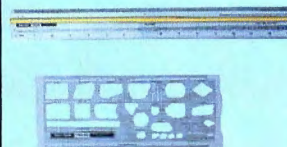

Programming Aids

Printview Ruler. 26-1313 3.50
Flowchart Template. Helps you draw legible flowcharts quickly and easily. 26-1312 3.95



Computer Books

Understanding Computer Science. 62-1383 3.95
Computer Programming in BASIC. 62-2015 2.95
BASIC Computer Language. Self-paced format for Level I BASIC. 62-2016 5.95
Dictionary of Microcomputer Terms. 62-1392 2.79

SYSTEM FURNITURE FOR HOME OR OFFICE WORKSTATIONS



Terminal Stand
A 19995



Deluxe Workstation
B 27995



Printer Stand
C 14995

A Deluxe Terminal Stand. Perfect for computer or terminal. Locking casters and large 30 x 30" tabletop adjustable at 26", 27" or 28". Easy to assemble.
26-4306 199.95

B Deluxe Workstation. This sturdy and spacious desk has pre-cut cable slots, rounded edges, and a scratch resistant 48 x 30" top.
26-4303 279.95
Desk Drawer. Mounts on left or

right of workstation (above).
26-4304 139.95
C Sturdy Printer Stand. Bottom paper feed slot. With wire basket.
26-4307 149.95
Computers, printer and accessories not included. Some assembly required.



Complete Workstation
29900

Reg. Separate Items 319.80

Computer, printer and accessories not included

Modular Units Have a Place for Everything

- Modern, Simulated Oak Finish
- All Components Are Easy to Assemble

- A System Desk.** Attractive and functional for home or office. Twin cable management slots. Adjustable glides. 27 x 49³/₄ x 29³/₈". 26-1356 119.95
- B Storage Hut.** Assembles with adjustable "second shelf" on either side. 26-1359 59.95
- C Corner Section.** Connects system desk and printer. Adds approximately 4 square feet of work surface. 26-1358 39.95
- D Printer Stand.** Large enough for wide-bed printers. Includes paper feed slot, paper catch and paper shelf. 27 x 28¹/₂ x 19¹/₂". 26-1357 99.95



Computer Table
This durable computer table is large enough to accommodate most home systems. Easy to assemble, with an attractive simulated wood finish.
27 x 48 x 24".
26-1324 79.95



Color Computer Desk and Printer Stand
Our Lowest Priced! 4995 Each

- A Compact Computer Stand.** With platform for monitor, plus a storage shelf. 26 x 32 x 19³/₄".
26-1354 49.95
- B Compact Printer Stand.** 26 x 26⁷/₈ x 19³/₄".
26-1355 49.95

Computer, printer, and accessories not included. Some assembly required.



B

OUR TOTAL SUPPORT INCLUDES OUTPUT FORMS AND ACCESSORIES



Stock Up on Fanfold Printer Paper

Our 9 1/2 x 11" sheets have "invisible" detachable, perforated margins. No ground wood or recycled paper. Single-part sheets are 15-pound bond unless otherwise noted. Multi-part sets are clean, carbonless, no-mess paper.

Fanfold Printer Paper				
Size	Design	Quantity	Cat. No.	Price
14 7/8 x 11"	Greenbar	500 sheets	26-1330	11.95
14 7/8 x 11"	Greenbar	1500 sheets	72-300	34.95
14 7/8 x 11"	Greenbar	3500 sheets	26-1417	69.95
14 7/8 x 11"	Blank White	1500 sheets	72-303	34.95
9 1/2 x 11"	Greenbar	1500 sheets	72-304	24.95
9 1/2 x 11"	Greenbar	3500 sheets	26-1403	49.95
9 1/2 x 11"	Blank White	500 sheets	26-1423	8.95
9 1/2 x 11"	Blank 20#	500 sheets	26-1387	10.95
9 1/2 x 11"	Blank 20#	1250 sheets	26-1427	24.95
9 1/2 x 11"	Blank 20#	2500 sheets	72-311	44.95
9 1/2 x 11"	Blank 2-Part	750 sets	72-305	34.95

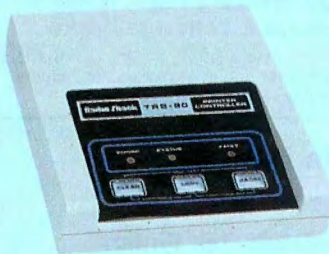

Printer Controller Adds Efficiency

249⁹⁵

PTC 64 Printer Controller. Now you can print one job while working on another. The PTC 64 accepts 62K of text and sends it to your printer as fast as the printer can handle it. Prints up to 100 consecutive originals. U.L. listed. 26-1269 249.95

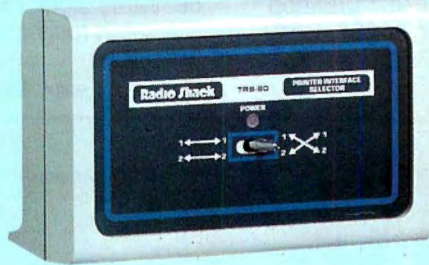

Printer Selector Switch

119⁹⁵

SW-302 Parallel Printer Switch. Connects two printers to one computer, or two computers to one printer. Standard parallel interface only. Cables not included. U.L. listed AC power module. 26-1498 119.95



Fanfold Mailing Labels

Smooth-feeding white mailing labels. Choose from 1, 2 or 3-wide.
1-Wide. Pkg./1000. 26-1328 6.95
1-Wide. Pkg./5000. 72-402 24.95
2-Wide. Pkg./2000. 72-401 15.95
3-Wide. Pkg./3000. 72-400 16.95



Printer/Monitor Platform

Accommodates standard computer monitor or narrow-bed printer (DMP 105, 110, 120 or 200, Line Printer VII or VIII). 16 3/4 x 13 3/4", with 5" clearance for printer paper. 26-1360 29.95
 Printer and paper not included



Printwheel Cleaning Kit

Clean clogged, recessed type areas. Easy to use and won't make a mess. For DW II, DWP 510, 410 and 210.
 26-1320 16.95
Refill Fluid and Pad.
 26-1322 5.95

thrills bin. It centers a group of concentric ovals on the screen using all 15 colors, then rapidly changes the color assignments to give the illusion of movement. It demonstrates the basics of using graphics commands, and also shows one of GW's more advanced features.

Start with the basics. Line 10 clears the screen, including the 25th line. The CLS command doesn't touch the 25th line, so as to leave intact the function key assignment display. You can't print text on that line, but you can put graphics there. Unfortunately, there's no simple way to clear graphics from the 25th line. The Key On : Key Off in line 10 flashes the key assignments momentarily. Your alternatives are to change to another screen mode and back with the Screen statement (jarring) or draw a filled black box in that area with the Line statement (slow).

The Screen statement in line 30 sets the display to mode 5 (medium resolution, 16 colors). Modes 4-6 require more RAM than the 16K default, so the Clear statement in line 20 sets aside the necessary 32K. The screen dimensions in medium resolution are 320 by 200 pixels, with the origin in the upper left-hand corner. Most graphics commands use this coordinate system.

The two Line statements in line 70 draw a vertical and a horizontal blue line centered on the display. The PRESET statement resets the center dot to black.

Lines 90-120 draw a series of concentric ovals centered on the screen with a For...Next loop that increases the radius I in the Circle statement by 10 each iteration. The variable CLR in line 100 cycles through all color values except black (1-15), so that each ellipse is a different color. The Circle statement's last parameter sets the aspect ratio of the ellipse; the default value, 1, makes a circle. You can draw large circles that only partially fit on the screen.

I've avoided mentioning the integer array A and the Palette Using statement, the trick that changes the colors via the loop in lines 130-180. When you specify a color for any of the graphics functions (e.g., the I in the Line statement), you're actually specifying the color assigned to the palette position with that number. A palette position's default color is its number: Palette position 1 is normally blue, color 1. You can change assigned colors with the Palette statement. The statement Palette 1,4 assigns red to palette position 1, and instantly changes any graphics in color 1 from blue to red.

The program's illusion of movement comes from sudden changes in color assignment, which the more powerful Palette Using statement accomplishes. You change all color assignments at once by specifying an integer array holding the new values. You specify an element in the array and the program assigns that value to palette position zero. The other palette colors are assigned sequentially from the array. In Listing 2, the array holds the colors 1-15 in

Program Listing 5. Illustration of graphics windows.

```
10 KEY ON : KEY OFF
20 CLEAR ,,,327681 : SCREEN 6 : CLS
30 WINDOW (0,0)-(639,199)
40 GOSUB 100
50 VIEW (20,30)-(310,90),3,1
60 GOSUB 100
70 VIEW (280,80)-(380,150),1,2
80 GOSUB 100
90 END
100 FOR Y = 1 TO 198 : X = .1*Y^1.65
110 PSET (X,Y),2
120 NEXT Y
130 RETURN
```

End

Program Listing 6. Illustration of text windows.

```
10 SCREEN 0 : WIDTH 80 : CLS
20 VIEW PRINT 1 TO 7
30 FOR I = 1 TO 15
40 PRINT TAB(15) "View Print 1 To 7 Does the same"
50 PRINT TAB(16) "as Poke 16916,7 on the Model III."
60 NEXT I
100 VIEW PRINT 15 TO 24
110 FOR I = 1 TO 15
120 PRINT TAB(11) "But can you do this with Model III Basic?"
130 PRINT
140 NEXT I
150 VIEW PRINT "Default is entire screen"
```

End

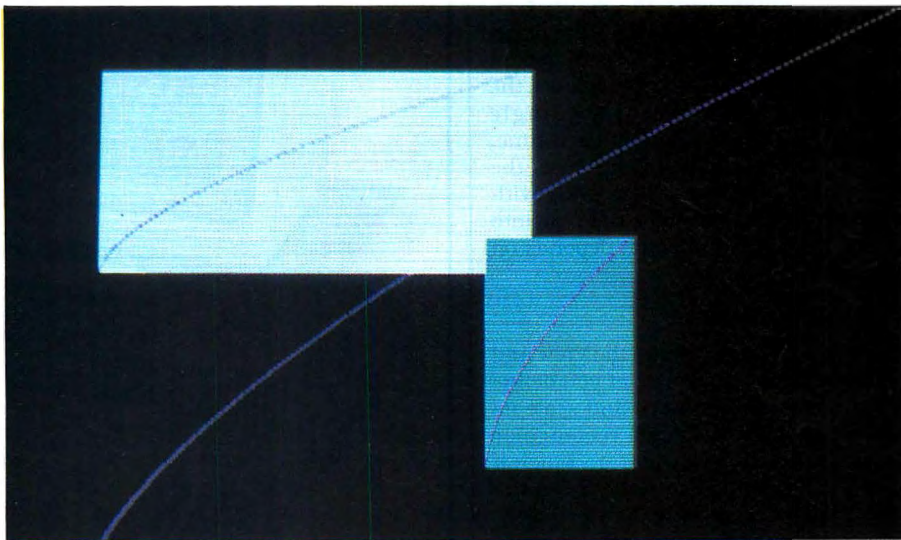

Photo. Screen windows using the Window and View statements.

sequential order twice (line 60).

The Palette Using statement cycles through this array in the loop in descending order, so the colored ellipses seem to move toward you. Line 140 temporarily keeps the color assigned to the background as black (color zero). Line 160 restores the array to its original condition.

Sketching Session

Perhaps GW-Basic's most sophisticated graphics feature is the Draw statement, which takes a string argument. In the string, you can specify a series of Logo-like cursor movement functions, or even refer to a substring that's defined to do something like draw a box. Program Listing 3, a screen sketch program, illustrates some of these abilities, and also uses event-trapping on the arrow and function keys. It

runs in the high-resolution, four-color mode 6.

Most of the program sets up event-trapping for function keys 1-3 (lines 130-160), function keys 11 and 12 (lines 170 and 180), and the four arrow keys (lines 190-230). The loops in lines 160 and 230 turn on event-trapping for the keys once you assign them subroutines. After doing this, the program spends its time in the loop in lines 250-320, unless you press one of the trapped keys.

The central loop executes a Draw statement with argument DR\$ (line 310) over and over. String DR\$ has the initial value of "M320,100", a Move command that puts a dot at position 320,100, the screen's center.

Pressing one of the arrow keys shunts the program to the appropriate subrou-

tine, where it changes part of DR\$ to a directional Move argument, either U1, D1, L1, or R1. These arguments specify one-increment moves, drawing as the cursor moves, either up, down, left, or right.

The subroutines return to the spot where the interrupt occurred. Once you press a directional arrow, the cursor never stops drawing; you just control the direction. Lines 250-290 check the cursor position (Point), and reverse direction if the cursor is going offscreen.

Function keys F1-F3 change the part of DR\$ that determines the line's color. Screen mode 6 has four colors, one of which is black, the background. The argument "C1" sets the cursor color to 1, the default of which is cyan. F11 clears the screen, after which the cursor starts at midscreen, the Draw command's default.

F12 stops the program, calling on the CLS subroutine, then resetting the screen mode to zero and the screen width to 80 columns.

You can use Draw to create some shapes that you can't get with Circle or Line, or that you can't easily plot with a function. Program Listing 4 draws a purple spiral, like a Nautilus shell. The Draw command's argument sets the color (C2), moves up 1 (U1), then changes the direction of "up" in degrees. "TA180" would cause up to be down. Line 40 changes the angle with each move. If the angle changes by the same amount each time, you get a perfect circle. In this case, the amount of change increases slightly with each repetition, so the circle tightens into a spiral. The degree of spiral depends on the variable C's value.

Screen Windows

Even better than Draw are the View and Window statements, which let you define an active area of the screen and scale its dimensions. View defines a rectangular area of the screen, a viewport, to which it confines all graphics activity. Even the CLS statement clears only the viewport.

The Window statement lets you scale the current viewport's coordinate system. You can scale the screen to fit the range of values of the data you're graphing.

Program Listing 5 demonstrates the powers of View and Window. It defines a coordinate system and plots the same hyperbolic curve in three different-sized viewports using that coordinate system (see the Photo). Line 20 clears adequate graphics space in RAM, then sets hi-res mode 6.

The Window statement in line 30 defines the window as having the same coordinate dimensions it normally would have in mode 6. Since the Window statement has no Screen parameter, the X coordinate goes positive up, which is what you'd want for plotting mathematical functions. If you specify the Screen parameter, the X axis is positive down, as the screen coordinates usually are.

The subroutine plots a magenta curve from the origin in the lower left-hand cor-

**TANDY[®]
COMPUTERS**

WITH THE
MANUFACTURERS
WARRANTY

ALWAYS AT "S"



- DISK DRIVES
- PRINTERS
- MODEMS
- SOFTWARE
- ALL RADIO SHACK PRODUCTS
- CHECK OUR SALE PRICES --- CALL ---

DFW COMPUTER CENTER

SALE" PRICES



MODEL 4

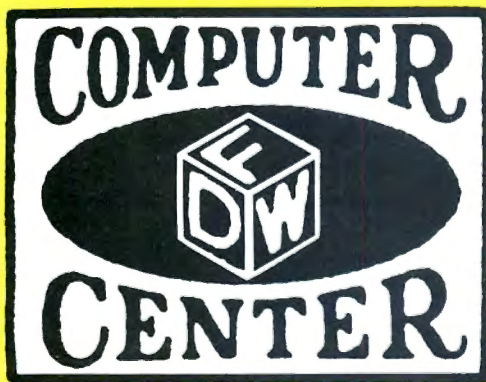

30 DAY
BUY BACK
POLICY
(Call for details)

CUSTOMER SERVICE
(817) 481-SALE
(9 a.m.-5 p.m. C.S.T)

TOLL FREE 1-800-433-SALE

326 Main St. Grapevine, Texas 76051

TEXAS BUYERS ADD 5 1/2% SALES TAX.

ner to the upper right-hand corner using the PSET statement. The program first plots the curve on the default viewport, the whole screen, then defines a second viewport in line 50.

Along with the coordinates that define size and location, I specified a white background with a cyan border for the second window. The white fills rather slowly and covers part of the first curve. If I hadn't specified a color, the background would stay black. The colored border is just thick enough to delineate a viewport from background of the same color, a nice touch. The third viewport is still smaller, and is cyan with a purple border.

Even though the three viewports have different proportions, the curve runs from one corner to the other. In one case the graph is flattened out; in another it's tall and skinny. By varying the parameters of the Window and View commands, you can play with a function curve's shape and proportions.

PSET and PRESET are the GW equivalents of Model III Basic's Set and Reset statements, dressed up to handle color. The GW Point command not only determines if you set a given coordinate, it also tells you the point's color, and you can use it to return the cursor's current position. In text mode only, you can use the Screen function to test a given screen position for the character there, or for color. Be aware that Reset in GW Basic performs the drastic task of closing all open disk files.

The View Print statement performs a similar windowing function with text. You can limit the active text screen to a range of screen rows, as you can by POKING to 16916 on the Model III. Program Listing 6 is an example. Note this difference from the graphics window: a CLS command clears the whole screen, not just the window.

As impressive as GW-Basic is, it still could be easier to use. The graphics commands, in particular, are frustrating to learn. That's the price of complexity. But when you've set aside enough memory, used the right variable types, and figured what works in which mode, the result can be excellent. That's the reward of complexity. ■

Dave Rowell is an 80 Micro technical editor who specializes in MS-DOS computers.

Related Articles

Heid, Jim, "The GW Difference," February 1985, p. 42. An introduction to GW-Basic that focuses on converting Model I/III/4 programs.

Lobdell, Gregory E., "A Better Breed of Basic," July 1984, p. 94. GW-Basic on the Tandy 2000.

Rowell, Dave, "The Tandy 1000 Tip Sheet," June 1985, p. 38. Helpful hints for Tandy 1000 owners including a section on GW-Basic.



Dueling Software

by Bradford N. Dixon
and Dave Rowell

This all started when 80 Micro technical editor Brad Dixon strolled over to colleague Dave Rowell's desk in the tech room and deliberately spilled coffee all over Rowell's DeskMate manual. Rowell slowly rose to his feet. He snatched the clip-on pen from Dixon's shirt pocket, threw it to the floor, and ground it under his heel. Before anyone could stop him, Dixon had picked up his softball glove and slapped Rowell's cheek with it. "You dare insult me," sneered Rowell, a cold, hard glitter in his eyes....

Of course, they had to fight a duel after that. Cruelly, Dixon proposed the most brutal of all blood sports—shopping. The challenge was to spend \$1,000 on software for the Model 4 and \$1,000 on Tandy 1000 software. The duellers would have to hunt mercilessly for bargains—each tapping his expertise in a particular machine—using every ounce of skill to find the most useful, highest-quality software for the money. Armed with hundred-dollar bills from a Monopoly game, Rowell and Dixon measured off 10 paces and the duel began. Here's what they bought.

Dixon's Picks

For me, the task of making a wish list of Model 4 software was pretty easy, since my background is with Tandy's Z80-based computers. The variety of good Model III/4 software for any application rivals that for any personal computer. The fact is, my \$1,000 wasn't enough for everything I wanted. I managed to find 13 programs and spend \$999.25 with no problem at all.

Buying MS-DOS software, however, was new to me. Like many TRS-80 owners, I haven't paid all that much attention to PC compatibles, except to envy the color and graphics capabilities of MS-DOS machines. I found fewer bargains for the 1000 software than for the Model 4—only nine programs for \$994.95.

Model 4

Allwrite \$199.95 from Prosoft, Box 560, N. Hollywood, CA 91603, 800-824-7888, oper. 422.

Manufacturer: Prosoft.

This isn't the least expensive Model 4 word processor around, but it is one of the most versatile. Word processing is the primary reason I use a computer, so buying a first-class program was the only way to go.

DotWriter 4.0 \$69.95 from JMG Software International, 3235 Lockport Road, Niagara Falls, NY 14305, 416-575-2867.

Manufacturer: Prosoft (see address above).

To go along with Allwrite, I chose a printer driver program that matched my word processor in number of features. Changing fonts and print sizes isn't for everyone, but it can spruce up an otherwise ordinary letter.

Double Duty \$69.95 from Tandy/Radio Shack, 1800 One Tandy Center, Fort Worth, TX 76102, 817-390-3011.
Manufacturer: Tandy/Radio Shack.

This well-regarded utility is one of three Radio Shack programs on the list; it lets you run two Model 4 applications simultaneously on a 128K system.

Two 80 Micro editors go gunning for a high-caliber software library.

Microlink II \$79 from B.T. Enterprises, 10 Carlough Road, Bohemia, NY 11716, 516-567-8155.

Manufacturer: B.T. Enterprises.

Microlink is the best terminal package I've found for the Model 4. It's easy to learn and use, and it takes advantage of Model 4 features in ways no rewritten Model III program does. I like it and use it.

Orchestra 90 \$68 from Montezuma Micro, Redbird Airport, Hangar 18, P.O. Box 32027, Dallas, TX 75232, 214-339-5104.

Manufacturer: Tandy/Radio Shack (see address above).

I've heard demonstrations of this music program; one of the reasons I chose it was for its entertainment value. Another reason is the amount of free music available for it on BBS systems and from CompuServe's Orchestra 90 special-interest group.

PFS:File \$107 from Montezuma Micro (see address above). Manufacturer: Software Publishing Inc., 1901 Landings Drive, Mountain View, CA 94043.

I've found this data base manager simple to learn and flexible to apply.

Planetfall \$34.50 from JMG Software International (see address above).

Manufacturer: Infocom Inc., 55 Wheeler St., Cambridge, MA 02138.

This is the only game on my Model 4 list. It may not be Infocom's most challenging adventure, but it does have the best sense of humor.

Supercross/XT and CNVBasic/CMD \$119.95 from Powersoft, 17060 Dallas Parkway, Suite 114, Dallas TX 75248, 214-733-4475.

Manufacturer: Powersoft.

You can buy these two utilities separately or as a package. Supercross/XT is a file-transfer utility that lets your Model 4 read Tandy 1000 disks and copy programs to or from those disks. A companion program, CNVBasic/CMD converts Model I/III programs to MS-DOS, CP/M, or Model 4 format. Both programs come in handy when you're programming on more than one computer.

Super Utility Plus 3.2 \$59.95 from AMI, 612 Washington, Denver, CO 80203, 800-468-4474.

Manufacturer: Powersoft (see address above).

No software wish list would be complete without Powersoft's Super U. You can use version 3.2 on Model III or 4 disks.

System Diagnostic \$99.95 from Howe Software, 14 Lexington Road, New City, NY 10956, 914-634-1821.

Manufacturer: Howe Software.

System Diagnostic tells the Model 4 owner what's right and what's wrong with his computer, from disk drives to memory.

TRSDOS 1.3 \$12 from Montezuma Micro (see address above).

Manufacturer: Tandy/Radio Shack (see address above).

Radio Shack's Model III operating system lets Model 4 owners tap the multitude of Model III software still available.

ZBasic 3.0 \$79.50 from JMG Software International (see address above).



Manufacturer: Simutek Computer Products Inc., 4897 E. Speedway, Tucson, AZ 85712.

Machine-language programming isn't for everyone, but everyone wants the speed of machine language. This Basic compiler converts Basic files to /CMD files.

Tandy 1000

EZ-Dos-It \$199.95 from Hammer Computer Systems, 700 Larkspur Landing Circle, Suite 285, Larkspur, CA 94939, 415-461-7633.

Manufacturer: Hammer Computer Products.

This program runs up to eight Model 1000 files concurrently without requiring a hardware modification. Using the control and function keys, you can simultaneously run all programs that can fit into the 1000's memory.

Flight Simulator \$34 from Applied Computer Products, 1633 Republic Road, Huntington Valley, PA 19006, 215-322-6500.

Manufacturer: Microsoft, 10700 Northrup Way, Bellevue, WA 98004.

Microsoft's classic has to be a must for any MS-DOS library.

Gato \$25 from Conroy-LaPointe, 12060 S.W. Garden Place, Portland, OR 97223, 800-547-1289.

Manufacturer: Spectrum Holobyte Inc., 1494 Greenbriar Blvd., Boulder, CO 80303.

This real-time submarine simulator is a challenge for players of any ability.

Microsoft Basic Compiler \$229 from CompuClassics, 6934 Canby St., Suite 104, Reseda, CA 91335, 800-328-4473.

Manufacturer: Microsoft (see address above).

Microsoft's compiler speeds up those normally slow-running GW-Basic programs.

The Norton Utilities \$48 from Computers Direct, 6232 Oakton St., Morton Grove, IL 60053, 800-848-0888.

Manufacturer: Peter Norton, 2210 Wilshire Blvd., Santa Monica, CA 90403.

Peter Norton's disk utility package is the Super U of the MS-DOS world. (At this writing, Powersoft was about to introduce its MS-DOS version of Super U.)

Sidekick \$30 from PC Connection, 6 Mill St., Marlow, NH 03456, 800-243-8088.

Manufacturer: Borland International, 4113 Scotts Valley Drive, Scotts Valley, CA 95066.

A concurrent desktop utility. With only a few keystrokes, you can display all the information you need to keep things organized: a calculator, a notepad, an ASCII table, and more.

Supercalc III \$219 from CompuClassics (see address above).

Manufacturer: Sorcim/IUS Micro Software, 2195 Fortune Drive, San Jose, CA 95131.

Supercalc III provides a better data base than DeskMate, along with the graphics I

TANDY CO

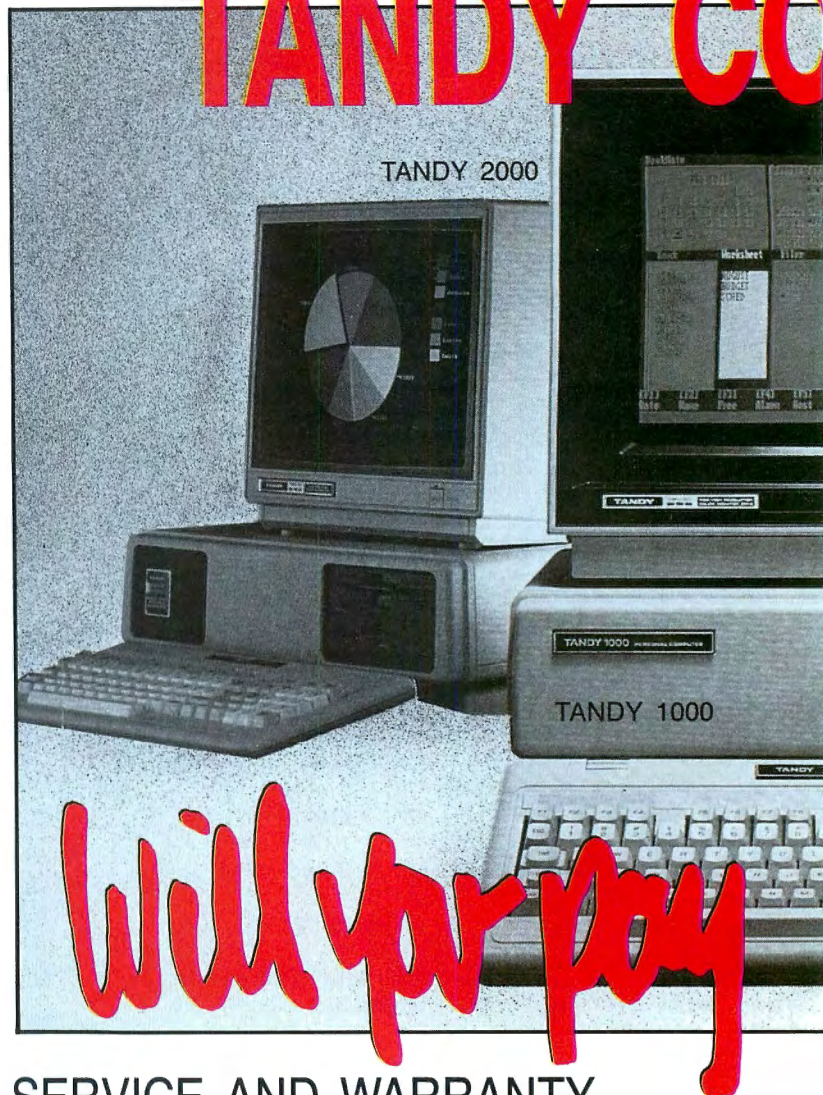

SERVICE AND WARRANTY NATIONWIDE

SAVE SALES TAX* PLUS DISCOUNT
(* TEXAS RESIDENTS ADD ONLY 4 1/8%)

CUSTOMER SERVICE/QUESTIONS ABOUT
YOUR ORDER and in TEXAS 1-817-573-4111
(9 am-5 pm TEXAS TIME MONDAY-FRIDAY)

Fort Worth Computers
377 Plaza
Granbury, Texas 76048



CALLFREE NUMBER:

COMPUTERS

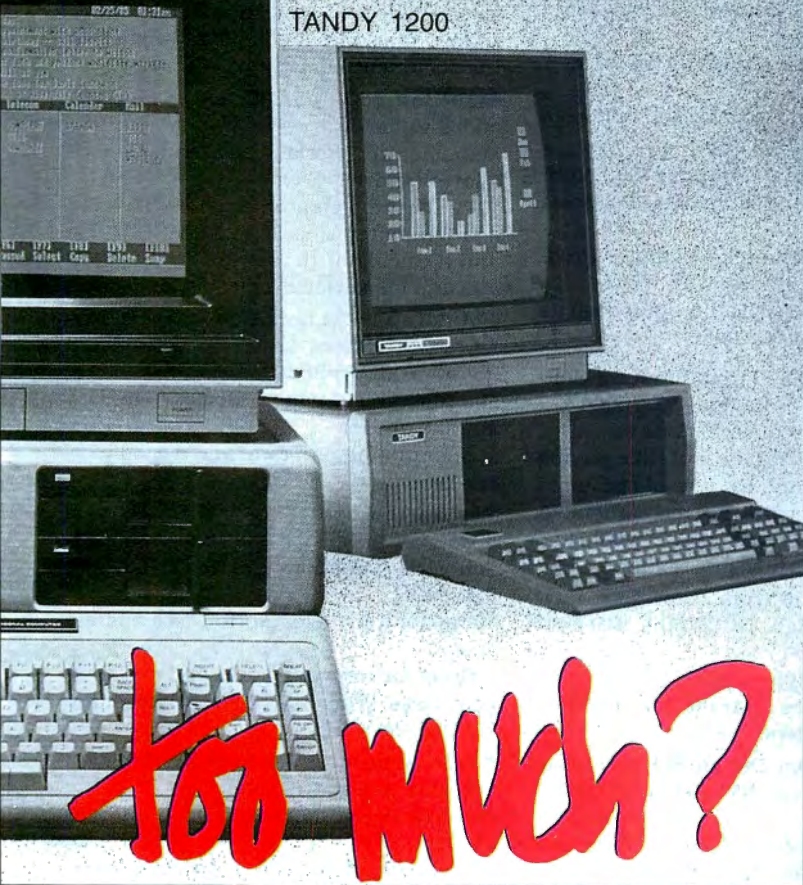

ASK ABOUT OUR
30 DAYS
 BUY BACK POLICY



Circle 214 on Reader Service card.

FORT WORTH COMPUTERS

(WE ARE SERIOUS ABOUT SAVING YOU MONEY)

Located 30 miles from Ft. Worth

For
 Prices

(1-800-) **433-S-A-V-E**

need to present data base or spreadsheet information. The price may be steep, but it's a program with applications beyond those I can list here.

ThinkTank \$105 from Conroy-LaPointe (see address above).

Manufacturer: Living Videotext Inc., 1000 Elwell Court, Suite 232, Palo Alto, CA 94303.

An idea processor for writers who need to outline their thoughts.

Volkwriter \$105 from Conroy-LaPointe (see address above).

Manufacturer: Life Tree Inc., 411 Pacific St., Monterey, CA 93940.

I found this popular word processor easy to use and flexible in handling printers and text-formatting commands.

DeskMate Free with a Tandy 1000.

Manufacturer: Tandy/Radio Shack (see address above).

I didn't include a terminal program in my list because DeskMate's is sufficient for me. The other utilities in the program no longer meet my needs, so I found more powerful programs.

Rowell's Choices

It was easier for me to come up with the Tandy 1000 list: I'm most familiar with MS-DOS computers. I'm a little less secure about my Model 4 choices.

The order of listing has some correlation with a program's importance for me. My listed prices usually don't include shipping, but I took shipping charges, or lack thereof, into account when comparison shopping.

I don't need a spreadsheet, so I didn't pick one for the Model 4. With the 1000, I can use DeskMate's. I suppose I could have fallen back on DeskMate for other types of software that I use rarely.

Once I made my Model 4 choices, it was easy to stay under \$1,000. There's plenty of room for a few luxury items if you spend wisely. I found 16 Model 4 programs for \$998. For the Tandy 1000, I got 12 programs for \$981 (good luck finding an MS-DOS software product for the remaining \$19). With the exception of the Borland International products and a few others, MS-DOS programs are pricier. I didn't have enough to buy a Basic compiler, for instance.

Model 4

Super Utility 4/4P \$70 from Montezuma Micro (see address above).

Manufacturer: Powersoft (see address above).

This disk utility is, in a word, indispensable.

Scriptit \$85 from Montezuma Micro (see address above).

Manufacturer: Tandy/Radio Shack (see address above).

The word processor I'm used to. A word processor is important to me, but I don't need lots of features. I'm going to soup up this one with the two add-ons below.



Powerscript \$35 from DiskCount Data, 2701-C W. 15th St., Suite 612, Plano, TX 75075, 214-680-8268.
 Manufacturer: Powersoft (see address above).

An enhancement package adding all the features of SuperScripts except proportional spacing and a couple of others.

Powerdriver \$30 from Powersoft (see address above).
 Manufacturer: Powersoft.

In case I want to use a non-Tandy printer for fancy stuff.

Electric Webster \$90 from Cornucopia Software, P.O. Box 6111, Albany, CA 94706, 415-524-8098.
 Manufacturer: Cornucopia Software.

I've just discovered that spelling checkers are worth the money.

Zork II \$40 from JMG Software International (see address above).
 Manufacturer: Infocom Inc. (see address above).

For adventure games, I like Infocom.

M-ZAL Macro Assembler \$80 from JMG Software International (see address above).

Manufacturer: Computer Applications Unlimited, P.O. Box 214, Rye, NY 10580.

I'm just getting started in machine-language programming. Hardin Brothers likes this one and the features seem right.

TRSDOS 1.3 \$12 from Montezuma Micro (see address above).

Manufacturer: Tandy/Radio Shack (see address above).

A small price to pay for the option of running Model III software.

ZBasic 3.0 Basic Compiler \$80 from JMG Software International (see address above).

Manufacturer: Simutek Computer Products Inc. (see address above).

For me, Z's overall features outweigh its lack of a chaining capability.

The Producer \$200 from Producer Software, Box 1245, Arlington, TX 76004.

Manufacturer: Producer Software.

I don't need a data base, but I like playing with data bases anyway. It would be fun to design my own with this recommended program writer. The enjoyment would justify the program's high price for me.

Hypercross \$50 from Hypersoft, P.O. Box 5115, Raleigh, NC 27609, 919-847-4779, 6-11 p.m.

Manufacturer: Hypersoft.

To transfer files from the Model III/4 to MS-DOS computers.

MTerm \$60 from Design Software, Box 42847, Las Vegas, NV 89104, 800-622-4070.

Manufacturer: Micro-Systems Software Inc., 4301-18 Oak Circle, Boca Raton, FL 33431.

I don't telecommunicate much. I'm more likely to transfer files via a null modem. This terminal program looks as if it'll do the job at a reasonable price.

Disk Drive Analyzer \$26 from Montezuma Micro (see address above).

Manufacturer: Tandy/Radio Shack (see address above).

Important with a Radio Shack computer, but not that important. As the ad says, "Why pay more?"

LS-Utility Disk \$50 from Logical Systems Inc., 8970 N. 55th St., P.O. Box 23956, Milwaukee, WI 52332, 800-248-3535.

Manufacturer: Logical Systems.

A good bunch of utilities that Super U doesn't provide.

Double Duty \$60 from Montezuma Micro (see address above).

Manufacturer: Tandy/Radio Shack (see address above).

This is a luxury, a gee-whiz program that's really handy from time to time. It does require a 128K machine.

Voyage of the Valkyrie \$30 from DiskCount Data (see address above).

Manufacturer: Not available.

I had \$32 of my \$1,000 left and went for something frivolous.

Tandy 1000

Perfect Writer (with speller) \$199 from Conroy-LaPointe Inc. (see address above).

Manufacturer: Thorn EMI Computer Software Inc., 3187 C Airway Ave., Costa Mesa, CA 92626.

This word processor has lots of features for the price, is easy to use, and has a speller. Doesn't tell you where you are in the document, though.

SideKick \$30 from PC Connection (see address above).

Manufacturer: Borland International (see address above).

The desktop program of choice if you're a programmer, since it has an ASCII table and a calculator that works in hexadecimal and binary formats.

ThinkTank \$99 from Northeastern Software, 88 Riders Lane, Stratford, CT 06497, 203-375-3860.

Manufacturer: Living Videotext Inc. (see address above).

An outlining program, and a good writer's crutch.

The Norton Utilities 3.0 \$55 from Business Computers of Peterborough, NH, School St., Peterborough, NH 03458, 603-924-9406.

Manufacturer: Peter Norton (see address above).

Great for recovering data and exploring your disks. (There's a Super Utility for the 1000 in the works.)

Flight Simulator \$32 from Northeastern Software (see address above).

Manufacturer: Microsoft (see address above).

A classic. More than a game, it shows what the 8088 can do.

MASM \$65 from MC-P Applications, 1630 Oakland Road, Suite A114, San Jose, CA 95131, 408-293-3360.

Manufacturer: Microsoft (see address above).

The standard assembler for PC compatibles.

dBase II \$249 from Northeastern Software (see address above).

Manufacturer: Ashton-Tate, 10150 W. Jefferson Blvd., Culver City, CA 90320.

The well-known relational data base. Not easy to use, but powerful; I want to experiment with it.

Copy II PC \$25 from Telasoft, 2222 E. Indian School Road, Phoenix, AZ 85016.

Manufacturer: Central Point Software Inc., 9700 S.W. Capitol Highway 100, Portland, OR 97219.

I promise I won't misuse it.

Turbo Pascal \$30 from PC Connection (see address above).

Manufacturer: Borland International (see address above).

The cheap way to learn Pascal.

SmartCom II \$89 from PC Connection (see address above).

Manufacturer: Hayes Microcomputer Products Inc., 5923 Peachtree Industrial Blvd., Norcross, GA 30092.



A reasonably priced terminal program.

Sorcerer \$29 from PC Connection (see address above).
 Manufacturer: Infocom Inc. (see address above).

One of my favorite adventure games. I got stuck in this one long ago.

Prokey 3.0 \$79 from Warehouse Data Products, 2701 W. Glendale Ave., Suite 6, Phoenix AZ 85021, 602-246-2222.
 Manufacturer: RoseSoft, 4710 University Way N.E., Seattle, WA 98105.

I haven't yet tried this keyboard macro definer on the 1000. It might help solve keyboard compatibility problems with other PC software. ■

Bradford N. Dixon and Dave Rowell are on the 80 Micro staff.

Note: The software prices quoted here were current in April 1985, and may have changed since then.

NEW! HARD DISK FOR TANDY® 1000*

Introducing **The Rose**® by OSICOM, Inc.

\$974
10 MB External
 Controller, Drive in enclosure with fan and power supply Cables, & Manual

\$899
20 MB Internal
 Controller, Drive Cables, & Manual

10 MB Internal
 Controller, Drive Cables, & Manual

20 MB External
 Controller, Drive in enclosure with fan and power supply, Cables, & Manual
\$699

Tape Backup
\$1195

Easily user-installed-fully documented instructions. System "boots" from hard disk without floppy diskette. Runs Lotus, DBASE II—and Tandy 1000 software. One year warrantee on all equipment. TOLL-FREE technical support hot-line.

Orders and Information Call:
 1-800-922-0881 TOLL FREE
 201-540-0144 IN NEW JERSEY
 or Write:

Cx 18 Bank Street
 Morristown, N.J.
 07960

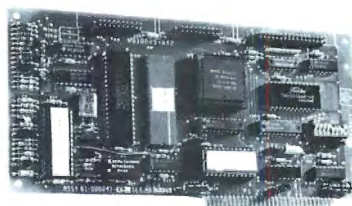

COD no Surcharge: Visa & MC 3%, Amex 5%.

* Requires Memory Expansion Board with DMA Controller (25-1004). Tandy is a registered trademark of Tandy Corporation.

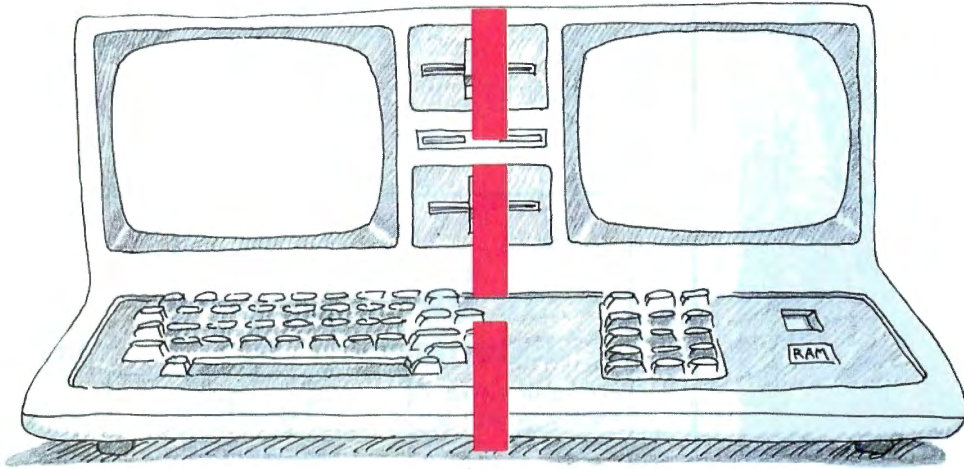

The Great Divide

by E. Cameron Snyder

Partition your 128K Model 4 so you can switch back and forth between two programs in Model III mode.

If you own a 128K Model 4 or 4P, chances are you've heard about Radio Shack's DoubleDuty utility, which splits your computer into independent partitions so you can switch between two Model 4 programs at will. But DoubleDuty works only with TRSDOS 6.X. Why waste your computer's extra memory and bank-switching feature when you run programs in Model III mode?

Times2 gives you DoubleDuty's capabilities for Model III programs by setting up two partitions operating under LDOS 5.1.X (see the Program Listing). You can load two Model III applications and switch back and forth between them, returning to each program just as you left it.

Even if you don't need double program operation, how many times have you been in the middle of a job and needed information from another program, or a simple directory listing. With Times2 installed, you can get that information and return with your job intact.

What You Get

Times2 is an interrupt routine that creates and switches between two partitions that function like two independent Model 4's in Model III mode. Unlike DoubleDuty, Times2 doesn't provide a third partition for library commands. But Times2's partition swapping is about 10 times faster than DoubleDuty's. Also, with my program, you only need a system disk available for the first swap or for a soft reset (described below).

Times2 uses 187 bytes of high memory and is nondestructive. It duplicates any routines resident in upper memory and above HIGH\$ when you install it and makes those routines active in the second partition as well as the first. This includes filters, routers, drivers, Debug or Clock status indicators, and the like. Any routines you activate after you install Times2 will work only in the partition in which you activate them.

The program duplicates active job control language (JCL) routines (those that call Times2) to the second partition. Therefore, when you enter the second partition, JCL takes control of your computer at the point right after Times2's invocation, even if the first partition has already completed the JCL operation. While you can use this creatively, it can also be a hindrance, in which case I suggest you invoke Times2 manually or use the command AUTO TIMES2.

Times2 has the added feature of speeding up the 4/4P's Model III-mode clock to run at 4 MHz. On the Model 4P, Times2 slows down the cursor-flash and key-repeat rates so you won't get dizzy and fall off your chair. It also compensates the real-time clock counter so that TIME\$ doesn't run at double speed.

I couldn't compensate the cursor-flash rate and real-time clock counter on the Model 4; they're maintained in ROM. If this bothers you, omit the fast clock option when you install Times2 (see below).

Don't forget that the clock is specific to the partition it's in. When you exit a partition, its clock stops until you reenter the partition.

Swap and Go

To install Times2, assemble the source code in the Listing and save it to disk. Type in TIMES2 at LDOS ready and press the enter key. If you want the clock speed doubled, hold down the F key immediately after pressing the enter key. When you see the message "Release the <F> key," you know that you invoked the fast clock speed. Oh, and do release the F key when prompted.

Now put a Model III program disk in drive zero (and another in drive 1 if necessary) and load your program as usual. To switch partitions, press the control and right-shift keys simultaneously, then release them. This is a toggle sequence; the same keys switch you back.

For applications that require a reset to exit them, Times2 has a soft reset feature so you don't have to press the computer's reset button; that way, you won't lose Times2 and the program in the other partition. You'll also find this feature useful in recovering from system crashes or as an easy out to the LDOS ready prompt.

To use the soft reset, hold down the control and right-shift keys while you press the left-shift key and release it. Remember to put a system disk in drive zero before you invoke a soft reset.

Times2 provides no special key sequence to disable itself. For that, you'll have to press the reset button.

Dos and Don'ts

Times2's installation will abort if you already have the program resident and active, if another application has already intercepted and changed the DOS exit interrupt vector, or if installation would lower HIGH\$ to below E000 hexadecimal (hex). Times2 can't duplicate more than 4K of high-memory routines to the second partition.

When one or a combination of these three conditions exists, Times2 generates an error message to let you know that it aborted its installation. If the second or third condition is true, you'll have to press the reset button and install the offending routines after you activate Times2. Remember, they're active only in the partition in which you install them.

Applications that don't respect HIGH\$ will destroy Times2. If an application disables interrupts, none of the key sequences described will do anything. In other words, Times2 won't work, since it's interrupt-driven. I think such applications are few, however. The only program I own that disables interrupts for an extended period of time is one that plays music, and who wants to switch partitions in the middle of a song, anyway?

If an application that requires a reset to exit scrambles the resident operating system beyond recognition, Times2 may be

rendered helpless. In such a case, try a soft reset and see what happens.

I'd caution against swapping partitions in the middle of disk accesses. Although I've done it successfully, I haven't tried it enough to ensure that it's safe. Programs usually disable interrupts during critical moments, preventing you from swapping, but keep the warning in mind.

I've found no problem with having the same file open in both partitions, but they've been relative files with fixed lengths. Obviously, if you're working with a file and you switch partitions, change the file's parameters, and switch back again, you could have a problem.

You can switch partitions during a printing job. When you switch back, the printer starts up where it left off. Don't send any output to the printer when you've left a printing job unfinished, though, unless you want mixed job output.

Switching during communications should be no problem as long as you don't switch while receiving data. Times2 doesn't send a stop-sending signal to the host, so you'll lose data. If your modem doesn't maintain the carrier signal without your software active, you may get disconnected, but that should be rare.

Don't try to SYSGEN Times2. You have to install it, because the program adjusts to its environment with the help of a loader, which you can't SYSGEN.

Times2 uses no interrupt slots. It intercepts the DOS exit from ROM, so active interrupt routines will be unaffected.

The program uses the second page of the video RAM, so avoid homebrew applications that use this area. You'll destroy screen information, and when you return to that partition, the screen won't look anything like the one you left.

Except for the special conditions outlined above, you can switch partitions in the middle of any input/output.

Program Structure

This section provides a general step-through to aid in interpreting and understanding Times2's source code. If you're not interested in the nuts and bolts of the program's operation, you can skip the section with impunity.

Times2 has four areas of operation. To minimize confusion, I labeled the source code with the same descriptive terms I'll use here.

I'll describe what each area accomplishes, not how it does so. Those who want more detail should study the com-



System Requirements

Model 4/4P
Model III mode
128K RAM
LDOS 5.1.X
Assembly language
Editor/assembler

Now you and
your TRS-80 can team up for

HASSLE-FREE PROGRAMMING with LOAD 80

UTILITIES
TUTORIALS, HOME &
HOBBY APPLICATIONS

It's true

More TRS-80* pleasure and fewer programming headaches can be yours all year with **Load 80**.

Load 80 comes in your choice of cassette or disk, and is filled with more than a dozen "ready to run" programs listed in **80 Micro**.

It's ready

"Ready to run" means the hard work has been done ahead of time! All you do is load and enjoy. No keyboarding hassles. No debugging.

Every *Load 80* features the high-quality tutorials, utilities, games, and word-processing programs you've come to expect from *80 Micro*. It has everything you need for enjoyable, practical, easy TRS-80 computing.

A subscription to *Load 80* is more than just a wise purchase. It's an investment! You'll be building your software library for a fraction of the cost of comparable programs sold in retail stores!

FREE assistance

Should you need assistance, the technical editors at *Load 80* and *80 Micro* will be ready to lend a hand. Hassle-free programming for you and your TRS-80 can begin right now with a year's subscription to *Load 80*. Simply return the postage-paid order card next to this ad, or call **TOLL FREE 1-800-258-5473**. In NH, dial 1-924-9471.

* TRS-80 is a registered trademark of Radio Shack, a division of Tandy Corp.

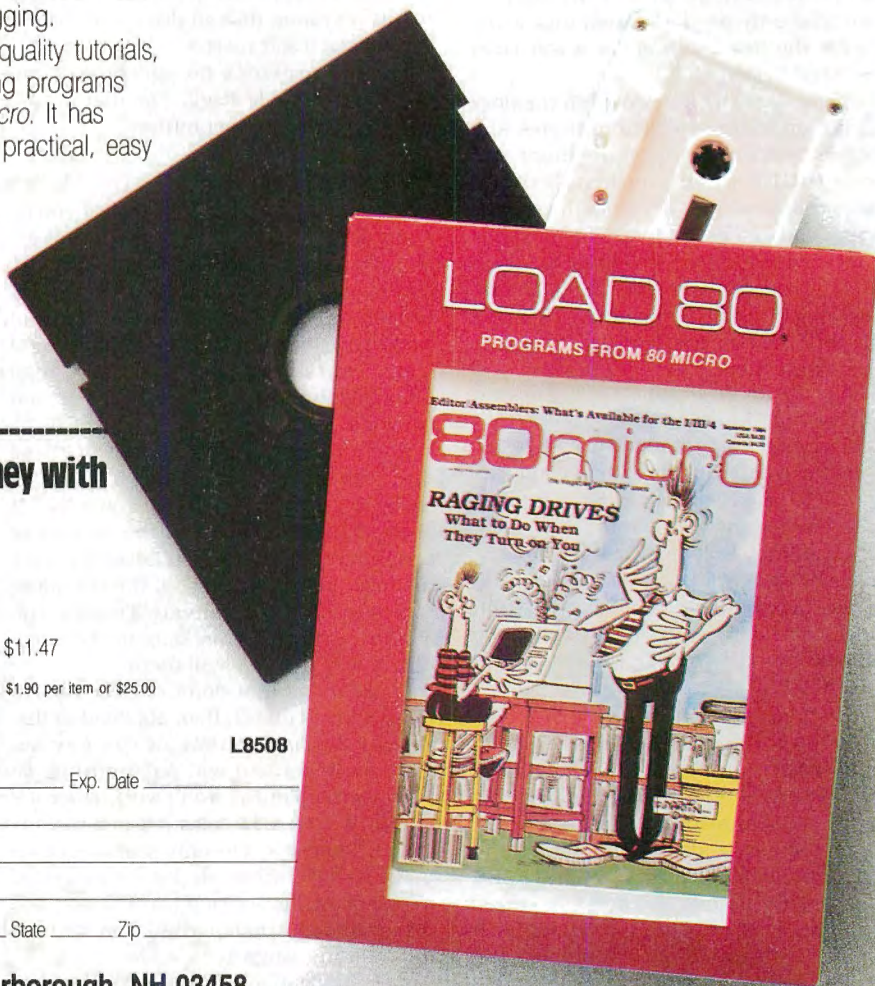

**Yes! Save me time and money with
LOAD 80. Send me:**

- 1 year of LOAD 80 on disk for \$199.97
- 1 year of LOAD 80 on cassette for \$99.97
- This month's LOAD 80 disk for \$21.47
- This month's LOAD 80 on cassette for only \$11.47

Prices include postage and handling. Foreign airmail please add \$1.90 per item or \$25.00 per subscription. U.S. funds drawn on U.S. banks only.

Check/MO MC Visa AE

L8508

Card # _____ Exp. Date _____

Signature _____

Name _____

Address _____

City _____ State _____ Zip _____

Load 80 • 80 Pine Street • Peterborough, NH 03458

mented source code in conjunction with the *Model 4 Technical Reference Manual's* hardware section.

Part 1, the loader, is the program's largest and most complex part. It checks the environment in which parts 2, 3, and 4 must operate and adjusts them accordingly. It finds where in high memory they must go to be out of the way.

The loader duplicates Times2 and any other high-memory-resident routines to what becomes the second partitions's upper half. It duplicates the operating system and all lower-memory functions into what becomes the second partitions's lower half. Finally, the loader puts part 2's

execution address into the DOS exit vector for interrupts.

Part 2 is serviced by the real time clock interrupt. It checks the keyboard to see if you're switching partitions. If not, it passes control to the system interrupt routine, which flashes the cursor or checks for type-ahead characters and the like.

If the routine detects a switching command, it puts part 3's execution address on the stack and passes control to the system interrupt routine. This way, when the system interrupt routine is finished and executes its return from interrupt, control automatically returns to part 3, not to the address where the interrupt occurred.

Program Listing. Times2's source code.

```

00090 ;      TIMES2/CMD Written by E Cameron Snyder (c)1985
00100 ;      Splits Model 4 running Model 3 mode into 2 partitions.
00110 ;
00120 ;
00130 ;
00140 ;      ;FIRST PART--LOADER
00150
00160
00170      ORG      5200H
00180 BEGIN  CALL      01C9H      ;CLEAR SCREEN
00190      LD       HL,3D00H
00200      LD       (4020H),HL
00210      LD       HL,MESS2      ;DISPLAY SCREEN HEADER
00220      LD       DE,3C05H
00230      LD       BC,53
00240      LDIR
00250      LD       HL,(4013H)      ;GET INT VECTOR
00260      LD       A,44H
00270      CP
00280      JR       Z,CONT      ;CHECK IF TIMES2 RESIDENT
00290 ERR   LD       HL,MESS3
00300      LD       DE,3C00H      ;IF SO DISPLAY ERROR
00310      LD       BC,86
00320      LDIR
00330      JP       EXIT      ;AND EXIT
00340 CONT  DI
00350      LD       HL,4210H      ;GET OPTIONS IMAGE
00360      LD       A,(HL)
00370      LD       (JSTPSD),A      ;SAVE THEM IN TIMES2
00380      LD       A,(3801H)
00390      CP
00400      JR       NZ,CONT2
00410      SET     6,(HL)
00420      LD       A,(HL)      ;ALTER OPTIONS IF <F>
00430      LD       (JSTPSD),A      ;SAVE THEM IN TIMES2
00440      OUT     (0ECH),A      ;ACTIVATE NEW OPTION
00450      LD       A,1      ;MAKE ROM
00460      OUT     (84H),A      ;IMAGE ADDRESSABLE
00470      LD       A,0CH
00480      LD       (3542H),A      ;INCREASE COUNTDOWN
00490      LD       A,3CH      ;TIMER LOCATIONS
00500      LD       (355DH),A      ;IN ROM
00510      LD       HL,MESS4
00520      LD       DE,3CD4H      ;TELL USER TO RELEASE
00530      LD       BC,19
00540      LDIR      ;<F> KEY
00550 LOOP4 LD       A,(3801H)
00560      CP       0      ;DONT
00570      JR       NZ,LOOP4      ;CONTINUE UNTIL RELEASED
00580      LD       A,20H
00590      LD       HL,3CD4H
00600      LD       B,19      ;ERASE MESSAGE
00610 LOOP5 LD       (HL),A
00620      INC     HL
00630      DJNZ  LOOP5
00640 CONT2 LD       A,2      ;CHANGE MEMORY ADDRESS
00650      OUT     (84H),A      ;SCHEME...MOVE VIDEO &
00660      LD       B,4      ;KYBD ADDRESSES TO HIGH
00670      LD       HL,0F800H      ;MEM & CLEAR WHAT WILL
00680      LD       A,20H      ;BE PARTITION 2'S SCREEN
00690 LOOP6 PUSH     BC
00700      LD       B,0
00710 CLEAR LD       (HL),A
00720      INC     HL
00730      DJNZ  CLEAR
00740      POP     BC
00750      DJNZ  LOOP6
00760      LD       HL,MESS      ;PUT PARTITION 2 HEADER
00770      LD       DE,0F800H      ;INTO PAGE 2 VIDEO
00780      LD       BC,23
00790      LDIR
00800      XOR     A
00810      OUT     (84H),A      ;RESTORE ADDRESS SCHEME
00820      LD       HL,402DH
00830      PUSH    HL
00840      LD       HL,(4411H)      ;GET HIGH$ & SAVE
00850      PUSH    HL      ;FOR NEXT CALCULATION

```

Listing continued

Mac Inker

Re-ink any fabric ribbon **AUTOMATICALLY** for less than 5¢. Extremely simple operation with built-in electric motor. We have a MAC INKER for any printer: cartridge/spool/harmonica/zip pack. Lubricant ink safe for dot matrix printheads. Multicolored inks, uninked cartridges available. Ask for brochure. Thousands of satisfied customers.

\$54.95 +



Mac Switch

Mac Switch lets you share your computer with any two peripherals (serial or parallel). Ideal for word processors—never type an address twice. Ask us for brochure with tips on how to share two peripherals (or two computers) with MAC SWITCH. Total satisfaction or full refund.

\$99.00

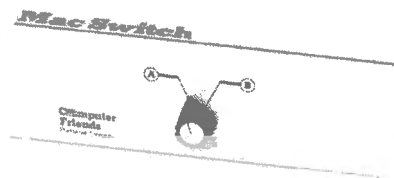

Order toll free 1-800-547-3303

Computer Friends

6415 SW Canyon Court
Suite #10
Portland, Oregon 97221
(503) 297-2321
Dealer inquiries welcome

PRINTER DRIVERS FOR SUPERSCRIPIT

Easily and automatically attach your printer to SuperSCRIPIT with an *ALPS software printer driver program*. No need to learn special printer codes. Call or write for info describing features supported on each printer (underline, bold, proportional, scripts, etc.).
Over 120 Different Printers Supported.
Custom Printer Driver For Each Printer.
2-1/2 years experience. Customer Support !!!
\$49 or \$59 each, depending on printer.

MSDOS UTILITIES
TANDY 1000, 1200, 2000
IBM PC/XT/AT
No Technical Knowledge Required !!! Easy to Use.

***** **R A M D I S K** ***** \$49
RAMDISK -- Use spare memory as a superfast disk to speed up applications. (You specify Ramdisk size). Appears to programs as a disk, but **gives instant access**. Easy to install and use.

***** **ALPHA TOOL BOX** ***** \$59
ALPHABETIZED DIRECTORY DISPLAY -- View Directory on 1 screen (**5 columns, sorted, Fast!**).
FIND FILE -- Search all directories for file.
DIRECTORY DTREE -- Display all sub-directory names in an easily readable form.
BACKMOD MODIFIED FILES -- Quick, automatic backup of files. Backup in same format as original. Perfect for Hard Disks. Also for floppies.

***** **BETA TOOL BOX** ***** \$59
SINGLE KEY COMMAND -- Define any text string (or DOS Command) as a single keystroke. Press **single key to execute commands!**
COUNT LINES -- Superfast count of lines in a file.
DUMP FILE IN HEX -- Formatted dump of file in Hex/Ascii. Scroll Forward, Backward, Begin, End.
CHANGE FILE ATTRIBUTES -- **Make files hidden, readonly, archive, etc.** Set or reset attributes.

***** **SERIAL PRINTERS** ***** \$49
Connect your Serial Printer to your RS232 port. Full handshaking. Easy commands. Complete instructions.

Don't miss the review of these ALPS utilities in the February, 1985 issue of 80-Micro (P.119).
More ALPS Tools Available. Call or Write for ALPS catalog. Customer Support !!!

ALPS
23 Angus Road
Warren, New Jersey 07060
201-647-7230

LETTER - WRITER™
"Integrated WORD PROCESSING Power"

BEST BUY

THE "BEST" SOFTWARE IS GUARANTEED!
TRY IT and LIKE IT, or GET a REFUND

The machine code disk L-W is "A" rated by Allenbach's "SOFTWARE REPORTS" for:

EASY USE, DOCUMENTATION, FEATURES

- FORM LETTERS and LABELS on any printer.
- ADD and SUB bookkeeping and tax columns.
- LEGAL PAPER LINE NUMBERING, Centering.
- Copy, move, delete, insert, merge, select.
- Screen display same as printout, unmodified M1 users can see and print up/lower case.
- MASS MAILER, graphics, cancel changes.
- SPLIT SCREEN typing line, see old and new versions, word wrap, disk warm start.
- Over 50 "one key" INSERTION PHRASES.
- ONE MODE: Type / Edit / Delete without switching modes — NO TRAINING PERIOD.

WE PAY TAX and USA SHIPPING. Try your L-W for 3 months. Like it or return it for a refund, less our shipping costs of: \$3.50.

Models I, III / IV: TAPE 16K \$ 27.99
DISK 32K (*Extra Features) \$ 47.99

10 Verbatim SS/DD \$ 19.99, DS/DD \$ 23.99
20 Microsette C-10 tapes and boxes \$ 13.95

ASTRO-STAR ENTERPRISES
5905 Stone Hill Dr. Information/orders:
Rocklin, CA 95877 (916) 624-3709

Orders: 1-800-622-4070
in IL 1-800-942-7317

Part 3 is the doorway or portal through which you pass to get to the other partition. It has two halves, one for leaving a partition and one for entering a partition. The routine's first half saves the address on top of the stack; this is the restart address, where the interrupt occurred and where the system should restart on reentry to the partition. Then, the first half saves all the registers so the second half can restore them on reentry, and switches partitions.

On entry to a partition, part 3's second half relocates part 4 to a safe area of lower RAM and passes control to it.

Part 4 does nothing more than save the exiting partition's screen and recover the entering partition's screen. It then returns control to part 3's second half, which recovers the reentry address from the stack, restores all the registers, and returns to where the interrupt occurred before the switch.

Modifications

If you like Times2's clock speed-up, but find it makes a game or other timing-critical program run too fast, you can reset bit 6 at location 4210 hex, then output the 4210 hex byte to port EC hex. The following four statements, inserted at the beginning of a Basic program, accomplish this:

```
var = PEEK(&H4210);
var = var AND 191 ;
POKE &H4210,var;
OUT &HEC,var
```

You should replace "var" with some numeric variable. These statements force the partition to go slow. You'll switch speeds when you swap partitions, since Times2 remembers a partition's speed. To force the partition to go fast again, use the same four statements, substituting OR 64 for AND 191 in the second statement.

If you get tired of pressing F and prefer to invoke the speed-up automatically, apply this patch from LDOS ready:

```
PATCH TIMES2/CMD (X'5237' = 00 00)
```

Users who've upgraded to LDOS 5.1.4 don't need the F key or the above patch for the speed-up, since the operating system already provides this as a default. Also, executing CMD "SYSTEM(SLOW)" or CMD "SYSTEM(FAST)" from Basic precludes the use of the Basic statements listed above, since those commands function properly on the Model 4/4P under the new version.

The 5.1.4 version doesn't compensate the real time clock, key-repeat and cursor-flash rates on the 4P however. If your cursor is zipping along out of control or flashing you into catatonia, use the F key or apply the patch listed above and all will be well. ■

Cameron Snyder, business manager for the Sacramento Family Service Agency, uses his computer for business and pleasure. You can write to him at 7308 E. Parkway, Sacramento, CA 95823, or via CompuServe's EasyPlex mail service, ppn. 70645,1354.

Put an Amber CRT in Your Computer

Now you can eliminate the strobe, flicker and fatigue from your computer terminal with a new amber Soft-View™ replacement CRT from Langley-St. Clair.

Available for the TRS-80, TeleVideo, Kaypro, Heath, DEC, Zenith, IBM PC, Apple III and a wide variety of other monitors. These new replacement display tubes use amber phosphors which exceed the European standards for persistence and color. And the "decay" or fade-out rate of the phosphor is the same as the "refresh" or scanning rate of the computer screen, so the display glows gently, rather than flickering like a strobe light — an annoying problem with inexpensive green phosphor tubes.

- Available in medium decay "European Phosphor" (the standard in Europe).
- Made with Lead/Strontium impregnated glass that stops X-ray emission.
- High-contrast double dark face glass that also cuts U.V. radiation.
- Face of tube is etched to stop glare.
- Easily installed...comes with pre-mounted hardware.
- Ideal for word processing and programming, yet fast enough for games and graphics.
- Warranted for one full year against manufacturing defects or tube failure.
- Comes with a 30 day money back guarantee.



ALSO IN GREEN



Call now to order your 'Soft-View™' CRT from Langley-St. Clair — \$99.95*
800 221-7070
 In New York call 212 989-6876

Langley-St. Clair
 Instrumentation Systems, Inc.
 132 W. 24th St. New York, NY 10011

Please specify computer and model number when ordering. Dealer inquiries invited.

TRS-80, TeleVideo, KayPro, Heath, DEC, Zenith, IBM PC and Apple III are registered trademarks of Tandy Corp., TeleVideo Corp., NonLinear Systems, Inc., Heath Co., Digital Equipment Corp., IBM, and Apple Computer, Inc. Soft-View is a Trademark of Langley-St. Clair Instrumentation Systems, Inc.

Listing continued

```

00860 LD DE,0E000H+187
00870 SBC HL,DE ;IS HIGH$ TOO LOW
00880 JP C,ERR ;IF SO GOTO ERR & EXIT
00890 POP HL
00900 PUSH HL
00910 LD BC, LAST-INTHLD ;BEGIN
00920 SBC HL, BC
00930 INC HL ;CALCULATING
00940 LD (P13+1),HL
00950 POP HL ;NEW
00960 PUSH HL
00970 LD BC, LAST-P7 ;ABSOLUTE
00980 SBC HL, BC
00990 INC HL ;ADDRESSES
01000 LD (P9+1),HL
01010 POP HL ;USED IN
01020 PUSH HL
01030 LD BC, LAST-CHG2 ;RELOCATED
01040 SBC HL, BC
01050 INC HL ;ROUTINE
01060 LD (P11+1),HL
01070 POP HL ;USING HIGH$ IN A FORMULA
01080 LD BC, LAST-START
01090 LD (STKHDR), SP ;FOR OFFSET
01100 SBC HL, BC
01110 LD (4411H),HL ;NEW MEM ADDR FOR HIGH$
01120 INC HL
01130 PUSH HL
01140 PUSH HL
01150 PUSH HL
01160 INC HL
01170 INC HL
01180 LD (P1+1),HL
01190 LD (P12+1),HL
01200 INC HL
01210 LD (P2+2),HL
01220 LD (P5+2),HL
01230 LD (P8+1),HL
01240 LD (P10+1),HL
01250 LD DE, 14
01260 ADD HL, DE
01270 LD (P3+1),HL
01280 POP HL
01290 EX DE, HL
01300 LD HL, (4013H)
01310 LD (P6+1),HL
01320 LD (4013H), DE ;TIMES2 INTO INT VECTOR
01330 LD (INTHLD), DE
01340 LD HL, START ;RELOCATE PARTS 2, 3 & 4
01350 LDIR ;TO HIGH MEM LOCATION
01360 LD DE, 6000H
01370 LD HL, 0FFFFH ;MOVE HIGH MEM ROUTINES
01380 POP BC ;INTO BANK 0
01390 SBC HL, BC
01400 PUSH HL
01410 POP BC
01420 INC BC
01430 POP HL
01440 PUSH BC
01450 LDIR
01460 LD HL, 6002H
01470 LD BC, CHG-JSTPSD
01480 ADD HL, BC ;CUSTOMIZE IT FOR
01490 INC HL ;PARTITION 2
01500 LD (HL), 60H
01510 LD BC, CHG2-CHG
01520 ADD HL, BC
01530 LD (HL), 32H
01540 LD BC, CHG3-CHG2
01550 ADD HL, BC
01560 LD (HL), 30H
01570 LD A, 30H ;SWITCH IN BANK 3
01580 OUT (84H), A
01590 LD HL, 6000H ;DUPLICATE ALL HIGH MEM
01600 LD DE, (4411H) ;ROUTINES TO BANK 3
01610 INC DE ;(UPPER HALF OF PARTITON
01620 POP BC ;2)
01630 LDIR
01640 LD A, 20H
01650 OUT (84H), A ;SWITCH IN BANK 2
01660 LD HL, 0
01670 LD DE, 8000H ;DUPLICATE BANK 0
01680 LD EC, 8000H ;TO BANK 2 (LOWER HALF
01690 LDIR ;OF PARTITION 2)
01700 LD A, 30H ;ALL DONE SWITCH BACK
01710 OUT (84H), A
01720 EXIT
01730 EI
01740 JP 402DH ;AND EXIT
01750
01760 ;PART TWO
01770
01780
01790 START JR HERE ;JMP PAST SAVE AREA
01800 JSTPSD DEFB 0
01810 STKHDR DEFW 0
01820 DEFW 0 ;FOR STACK
01830 DEFW 0 ;AND REGISTERS
01840 DEFW 0
01850 DEFW 0
01860 DEFW 0
01870 BTMSTK DEFW 0
01880 INTT POP AF ;RESTORE
01890 P6 JP 0 ;AND RESUME INT TASKS
01900 HERE PUSH AF

```

Listing continued

Circle 159 on Reader Service card.

NEW DATABASE!

LITTLE BROTHER

for TRS80 Model 4/4P, Tandy 1000, 1200, 2000

EASY TO USE!

Menu driven - no complex command language to learn.

AUTO START-UP AND RUN!

Built in automatic job process. No creation of complex JCL or BATCH files necessary.

COMPLETE!

Includes Select and Sort, full Report Writer, printer control characters, etc.

SUPPORTED!

Full time support staff to answer any questions you may have.

BEST OF ALL - INEXPENSIVE!

The Little Brother data-base - easy to learn and easy on your pocketbook!

TRSDOS 6.2 L-50-510 only \$99
MS-DOS L-86-510 only \$99

Domestic orders add \$1 shipping plus \$5 handling for orders not prepaid with check or money order.

LOGICAL SYSTEMS
C.

The New Retail Operation of LSI Products.

P.O. Box 23956
Milwaukee, WI 53223

TOLL FREE ORDERLINE

(800) 248-3535

Information Number
(414) 355-5454



Rose

You've Got TOTAL ACCESS

(specializing in TRS80 *)

TO YOUR COMPUTER HARDWARE & SOFTWARE
NEEDS. CALL ROSE TODAY!

QUALITY DISK DRIVES

These drives are complete with power supply, cover and external drive connector. For TRS-80 Model I, III, 4, IBM PC and others. All drives are Double Density and step at 6ms or less. SS means single head, DS is double head. Specify white or silver color cover. Add \$5 per drive shipping unless otherwise specified. All drives have a one year warranty on parts and labor.

COMPLETE FULL SIZE 5.25" DISK DRIVES

40tk Single Side Tandon TM100-1.....	\$ 167
40tk Dual Side Tandon TM100-2.....	197
80tk Dual Side Tandon TM101-4.....	297

COMPLETE HALF-HIGH 5.25" DISK DRIVES

1ea. 40tk SS TEAC FD-55A in dual case.....	\$ 167
2ea. 40tk SS TEAC FD-55A in dual case.....	317
1ea. 40tk DS TEAC FD-55B in dual case.....	167
2ea. 40tk DS TEAC FD-55B in dual case.....	357
1ea. 80tk DS TEAC FD-55F in dual case.....	217
2ea. 80tk DS TEAC FD-55F in dual case.....	387

COMPLETE 8" DRIVES Add \$10 shipping

2ea. SS TM848-1E's in dual case with fan...	\$ 647
2ea. DS TM848-2E's in dual case with fan....	697

BARE 5.25" & 8" DRIVES Add \$4 shipping

40tk SS, Full Size, Tandon TM100-1.....	\$ 127
40tk DS, Full Size, Tandon TM100-2.....	167
80tk DS, Full Size, Tandon TM101-4.....	267
40tk SS, Half-High, TEAC FD55-A.....	147
40tk DS, Half-High, TEAC FD55-B.....	187
80tk DS, Half-High, TEAC FD55-F.....	237
8" SS, Thinline, Tandon TM848-1E.....	259
8" DS, Thinline, Tandon TM848-2E.....	333

TRS-80 MODEL III/4 DISK KITS

Internal drive kit complete with disk controller, power supply, mounting brackets, cables and all hardware plus step-by-step instructions. This kit contains everything you need (except the Disk Operating System, drive and a screwdriver) to convert your cassette Model III or 4 to fast reliable disk operation. Don't confuse this quality kit with the high-priced ripoffs. Thousands of satisfied customers cannot be wrong. You can join them for only..... Add \$8 shipping per kit. \$ 189

Same as above with 1-40tk SS drive.....299
Same as above with 2-40tk SS drives.....419

TRS-80 MODEL I DOUBLE DENSITY CONTROLLERS Add \$3 shipping

Aerocomp "DDC" Really the best by test.....	\$ 99
Aerocomp "DDC" with LDOS.....	159
Aerocomp "DDC" with NEWDOS 80-v2.0.....	179

OTHER DRIVE GOODIES Add \$2 shipping

TRSDOS 1.3 Disk & Manual for Model III.....	\$ 24
TRSDOS 2.3 Disk & Manual for Model I.....	24
TRSDOS 6.x Disk & Manual for Model 4.....	19
LDOS for the Model I or III.....	69
NEWDOS 80 v2.0 for the Model I or III.....	99
2-drive cable for Model I/III/4.....	24
2-drive external cable for IBM PC.....	48
4-drive cable for Model I.....	34
Extender cable, 7' long.....	9
5.25" power supply & encl., white or silver.....	59
8" power supply, fan & enclosure, beige.....	149

TRS-80 SPECIAL EQUIPMENT

12" Green Phosphor Monitor.....	79
12" Amber Phosphor Monitor.....	84
16K 200 nsec RAM Guaranteed 1 year (8 chips)...	9
64K 200 nsec RAM Guaranteed 1 year (8 chips)...	34
64K RAM plus Genuine PAL for Model 4 upgrade...	44

MEDIA & SUPPLIES

5" Diskettes SSDD, Lifetime Guar. Pk of 10...	\$ 16
5" Diskettes DSDD, Lifetime Guar. Pack of 10...	19
5" Flipsort, holds 75 Diskettes.....	19
8" Diskettes SSDD, Lifetime Guar. Pack of 10...	29
8" Diskette DSDD, Lifetime Guar. Pack of 10...	34
8" Flipsort, holds 50 Diskettes.....	24
5.25" or 8" Head Cleaning Kit.....	9
Letter Size 20 lb. Tractor Paper, 2900 sheets...	25

ROSE GETS RIGHT! NOW---ROSE'S MOD 4 CP/M \$ 69

Complete with Manual

Rose has latched onto this slick version of CP/M 2.2 that allows you to run most of your favorite CP/M programs with ease. It even lets you read and write other manufacturers' disk formats. What could be nicer? They are in stock ready for you to use and enjoy.

PRINTERS & ACCESSORIES

PROWRITER 120cps, 10" Wide Friction/Tractor.....	319
PROWRITER 2, 120cps, 15" Wide Frict/Trac.....	595
STARWRITER F10-40cps Daisy Wheel.....	895
LPRINTMASTER F10-55cps Fast Daisy Wheel.....	995
Rutishauser Bidirectional Tractor.....	150
Rutishauser Sheet Feeder, A Best One.....	495

CP/M & 80 COLUMN for your MODEL III

No need to buy a new computer when you can use the Holmes VID-80 modification and get CP/M 2.2, 64K RAM and 80 column video. This kit is easy to install and requires no soldering. Even a dolt like you can end up with a complete 64K CP/M computer with an 80 column screen that is still able to run all your existing Model III software. For the first time you will be able to use CP/M programs that normal people do, such as dBASE II and WordStar. The regular price of this kit is \$524. Now Rose will get you going for only..... **\$ 299**

Add \$5 shipping

SUPER SALE

I'll ship you the Holmes deal above PLUS WordStar 3.3 installed and ready to run for only..... **\$ 399**

SPECIAL SOFTWARE DEALS

<small>Add \$4 shipping</small>	
WordStar 3.3 (Specify MM or R/S format).....	\$ 195
MailMerg, SpellStar, Starindex, all 3 for just.....	99
WordStar Professional (Above 4 Programs).....	275
DataStar Data Entry & Retrieval.....	125
ReportStar Report Generator.....	105
InfoStar Advanced DBMS (Above 2 Programs)...	195
dBASE II Complete With Disk Tutorial.....	345
Super Utility Plus 3.2 by Kim Watt.....	59
CP/M 2.2 for Model 4 by Monte Zuma.....	169
Turbo PASCAL by Bor Land. Requires CP/M.....	44
Turbo Toolbox by Bor Land.....	45
Turbo TUTOR by Bor Land.....	35
Pickles & Trout CP/M 2.2m for the Model	
2-12-16. Floppy Version.....	179
Same thing but the Radio Shack Hard Disk.....	219

ORDER NOW! TOLL-FREE

800-527-3582

Orders Only Please

Call in your order or write to us at the address below. Texas residents call us at 214-337-4346 and deduct \$2.00 from your order but you should remind me 'cause sometimes I forget. If you need technical information or service please call the Texas number as the Toll Free lines are just for orders only. Prices are subject to change without notice and are mail order only. I accept AMERICAN EXPRESS, MASTERCARD and VISA and I will not charge your card until I ship your goodies. You can send a check or a money order. I also accept COD orders but they require cash or a cashier's check upon delivery. If shipping charges are not shown please call for the correct amount. Add \$5.00 handling charge if your order is less than \$50.00. Shipping charges quoted in this ad are for the lower 48 states only. Orders to Canadian address add \$20.00 to pay for doing all those papers for customs. Texans add State Sales tax. No tax collected on shipments outside of Texas. Be sure you know what you are buying. SOFTWARE IS SOLD ON A REPLACEMENT BASIS ONLY - NO REFUNDS. If it is defective call us for instructions. Please order from me now---I need the money and I will not jack you around. I reserve the right to charge up to a ten percent restocking charge if you jack me around. All merchandise carries the original manufacturers' warranty and all repairs or adjustments will be made by the manufacturer or his designated representative.

NEXT DAY SHIPMENT of Goods in Stock.

TOTAL ACCESS

P.O. Box 790276

Dallas, Texas 75379

214-337-4346

Listing continued

```

01910 LD A,(3880H) ;CHECK KYBD FOR SWITCH
01920 CP 6 ;COMMAND
01930 JR NZ,INTT ;NOT PRESSED, RETURN
01940 POP AF
01950 P8 LD (STKHDR),HL
01960 P9 LD HL,P7 ;PRESSED SO SAVE PART
01970 PUSH HL ;THREE'S ADDRESS TO STACK
01980 P10 LD HL,(STKHDR)
01990 JR P6 ;CONTINUE W/ INT ROUTINE
02000
02010
02020 ;FIRST HALF--PART THREE
02030
02040
02050 P7 DI
02060 PUSH AF
02070 LOOP LD A,(3880H)
02080 CP 7 ;SOFT RESET COMMAND?
02090 JR Z,RESET ;YES, GOTO IT
02100 CP 0
02110 JR NZ,LOOP
02120 LD A,(4210H) ;GET OPTIONS AND
02130 P1 LD (JSTPSD),A ;SAVE FOR THIS PARTITION
02140 POP AF
02150 P2 LD (STKHDR),SP ;SAVE STACK LOCATION
02160 P3 LD SP,INTT ;POINT STACK TO SAVE AREA
02170 PUSH AF ;SAVE REGISTERS
02180 PUSH BC
02190 PUSH DE
02200 PUSH HL
02210 PUSH IX
02220 PUSH IY
02230 CHG LD A,30H
02240 OUT (84H),A ;SWITCH IN NEW PARTITION
02250
02260
02270 ;SECOND HALF--PART THREE
02280
02290
02300 RTN POP IY ;RESTORE REGISTERS
02310 POP IX
02320 POP HL
02330 POP DE
02340 POP BC
02350 POP AF
02360 P5 LD SP,(STKHDR) ;RESTORE STACK POINTER
02370 PUSH AF
02380 PUSH BC ;SAVE REGISTERS USED
02390 PUSH HL ;BY PART FOUR
02400 PUSH DE
02410 LD DE,4300H
02420 P11 LD HL,CHG2 ;RELOCATE PART FOUR
02430 LD BC,MESS-CHG2
02440 LDIR
02450 CALL 4300H ;CALL PART FOUR
02460 P12 LD A,(JSTPSD) ;GET OPTIONS FOR THIS
02470 LD (4210H),A ;PARTITION AND RESTORE
02480 OUT (0ECH),A
02490 POP DE
02500 POP HL
02510 POP BC
02520 POP AF
02530 EI
02540 RET ;CONTINUE WITH PROCESSING
02550 RESET LD A,(3880H)
02560 CP 0
02570 JR NZ,RESET
02580 POP AF
02590 P13 LD HL,(INTHLD) ;SOFT RESET SECTION
02600 LD (4013H),HL
02610 EI
02620 JP 402DH
02630
02640
02650 ;PART FOUR
02660
02670
02680 CHG2 LD A,62H ;CHG MEMORY SCHEME
02690 OUT (84H),A
02700 LD DE,3C00H ;MOVE PRESENT SCREEN
02710 LD HL,0FC00H ;TO SHADOWED RAM
02720 LD BC,1024
02730 LDIR
02740 LD DE,0FC00H ;MOVE VIDEO PAGE 2
02750 LD HL,0F000H ;TO VIDEO PAGE 1
02760 LD BC,1024
02770 LDIR
02780 LD HL,3C00H ;MOVE SHADOWED RAM
02790 LD DE,0F000H ;TO VIDEO PAGE 2
02800 LD BC,1024
02810 LDIR
02820 CHG3 LD A,60H ;RESTORE MEMORY SCHEME
02830 OUT (84H),A
02840 STOP RET ;RTN 2ND HALF PART THREE
02850 INTHLD DEFW 0
02860 LAST DEFB 0
02870 MESS DEFM '*** Partition Two ***'
02880 MESS2 DEFM '<<< TIMES2 -'
02890 DEFM ' Written by E. Cameron Snyder'
02900 DEFM '(c)1985 >>>'
02910 MESS3 DEFM 'TIMES2 already resident or other CONFLICTING routine resi
dent.'
02920 DEFM 'Push RESET and reload.'
02930 MESS4 DEFM 'RELEASE THE <F> KEY'
02940 END DEFM
    
```

End

MODEL 4 OWNERS

Want More Performance?
More Speed?

OVERDRIVE "The Extra Burst"

Store all DOS overlays in one alternate memory bank. Also increased floppy disk performance with full track buffering on up to 2 drives. Takes NO room in normal high memory! (128K required).

DSM4 "The Super Sort"

Fast machine language sort. Creates a sorted index for your data files. Handles ASCII types along with BASIC integers, single and double precision. Limited only by disk space - NOT by memory!

BEEP "Keystroke Saver"

For BASIC programmers. Allows abbreviations for Edit, List, etc. Arrow keys to view program lines. High speed program load and save. Don't pass up this time saver!

OVERDRIVE L-35-220 for just \$99
DSM4 L-35-205 for just \$99
BEEP L-35-209 for just \$49

Domestic orders add \$1 shipping plus \$5 handling for orders not prepaid with check or money order.

LOGICAL SYSTEMS CO.

The New Retail Operation of LSI Products.

P.O. Box 23956
Milwaukee, WI 53223

TOLL FREE ORDERLINE
(800) 248-3535
Information Number
(414) 355-5454

Price Changes
Occur On A
Daily Basis.
Please Call
1-800-343-8841

PRICE BREAKTHROUGH

Price Changes
Occur On A
Daily Basis.
Please Call
1-800-343-8841

80

Super Sale on New Hard Drives

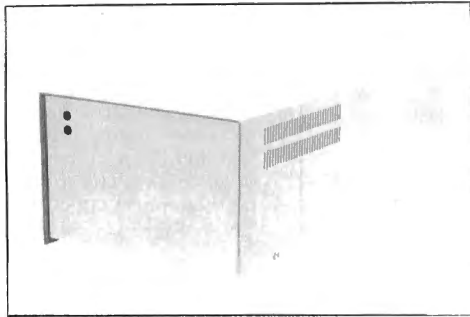

Fully Warranted
DRIVE A HARD BARGAIN™ starting at **\$599.95**

Introducing

MEGADISK™

Winchester Hard Drive Ready to run on the TRS 80 Model I/III/IV/4P, Color Computer, I.B.M.-PC, Max/80. Software Drivers: LDOS, NEWDOS/80, DOSPLUS, TRSDOS 6.x

*Montezuma Micro CP/M available

MEGAPLEX your Megadisk for \$899.95

Use up to 4 computers, multiplexed with 1 megadisk
Easy to install

Call Toll Free Ordering 1-800-343-8841

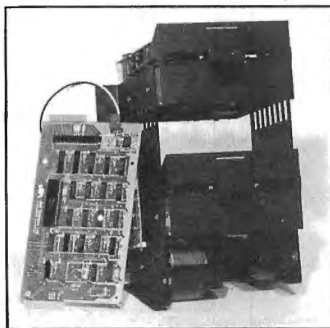

Disk Drive Upgrade Kit
for Model III/IV easy to install system — no soldering.
Complete with controller, towers, power supply, 1 disk drive, cables, and easy to follow instructions.
Starting at \$289.95

CANADIAN CUSTOMERS PLEASE CALL 514-662-3224

© 1985 SOFTWARE SUPPORT, INC.

1 Edgell Road, Framingham, MA 01701 (617) 872-9090 Telex-383425

Hours: Mon. thru Fri. 9:30 am to 5:30 pm (E.S.T.) Sat. 10 am to 3:30 pm

SERVICE POLICY — Our Professional Technical Staff Is Available To Assist You Monday Through Saturday.

WARRANTIES — Up To One Full Year Parts And Labor. Floppy Disk Drive Power Supplies — Five (5) Years.

SERVICE — 24 Hour Turn-A-Round On All In-Stock Parts. Dealer Inquiries Invited. Call 617-872-9090

Please Call For Shipping,
Handling And Insurance.

Toll Free 1-800-343-8841

Please Call For Our Latest Price Saving Specials.

Not Responsible for Typographical Errors.
Prices and Specifications May Change
Without Notice.

Prices Change
Every Day.
Please Call
1-800-343-8841
For Lower Prices.

PRICE BREAKTHROUGH

Prices Change
Every Day.
Please Call
1-800-343-8841
For Lower Prices.

DEALER INQUIRIES INVITED

MEGADISK™ HARD DISK DRIVE SYSTEMS

TOLL FREE ORDERING 1-800-343-8841

For the { IBM/PC, Tandy 1000, TRS/80 Models I/III/IV/4P, Compaq, Tava, PC Workalikes, Color Computers, Heath/Zenith, Max/80

{ Complete with Hardware, Cables, Software and Quikfit Installation

5 Megabytes Internal Mount	starting at \$ 299.95
10 Megabytes Internal Mount	starting at 479.95
20 Megabytes Internal Mount	starting at 679.95
5 Megabytes External System	starting at 599.95
10 Megabytes External System	starting at 799.95
20 Megabytes External System	starting at 999.95
Tape Backup System — Internal Or External	starting at 499.95

Wow! New Low Prices

DOS Systems Available: { IBM/Heath — DOS, 1.0, 2.0, 2.1, 3.0, or later
TRS/80-LDOS, TRSDOS 6.x, Newdos/80, Dosplus 3.5, CP/M, COCO DOS, Max/80 LDOS, OS9

FULLY WARRANTIED — PARTS AND LABOR — 24 HOUR SERVICE — CALL TOLL FREE — 1-800-343-8841

FLOPPY DISK DRIVES, POWER SUPPLIES AND CABINETS

Our Disk Drives are UL approved — Our Floppy Drive Cabinets and Power Supplies are Underwriters Laboratory Listed and have passed the required Federal Communications Part 15 Section B-EMI/RFI tests.
Warranty on all disk drives is one full year parts and labor. Warranty on floppy disk drive power supplies is five (5) years. In warranty or out of warranty service is 24 hour turn-a-round on all disk drives and power supplies.

Tandon — Full Height Drives	
100-1 Single Sided 40 tk Bare	\$120.00
In Case with Power Supply	149.95
Dual Drives in One Cabinet	279.95
100-2 Dual Sided 40 tk Bare	130.00
In Case with Power Supply	174.95
Dual Drives in One Cabinet	314.95
Half High Drives	
65-1 Single Sided 40 tk Bare	89.95
In Case with Power Supply	129.95
Dual Drives in One Cabinet	219.95
65-2 Dual Sided 40 tk Bare	115.00
In Case with Power Supply	154.95
Dual Drives in One Cabinet	269.95
TEAC Half High Drives	
55A Single Sided 40 tk Bare	89.95
In Case with Power Supply	129.95
Dual Drives in One Cabinet	219.95
55B Dual Sided 40 tk Bare	115.95
In Case with Power Supply	154.95
Dual Drives in One Cabinet	269.95
55F Dual Sided 80 tk Bare	140.00
In Case with Power Supply	184.95
Dual Drives in One Cabinet	324.95
Apple/Franklin Disk Drives	
35/40 Track in Case with Cable and Software	129.95
Commodore Disk Drives	236.95
Power Supplies and Cabinets 5/8" and Hard Drive Systems	starting at 42.00

COLOR COMPUTER DISK DRIVE SYSTEMS AND ADD IN PRODUCTS

40 Track Single Head Drive with Case, Power Supply, Cable	
Controller, Instruction Booklet, Diskettes	\$229.95
Above with Dual Drives in One Cabinet	319.95
40 Track Dual Head with Case, Power Supply, Cable,	
Controller, Instruction Booklet, Diskettes	269.95
Above with Dual Drives in One Cabinet	384.95
128 Memory Upgrade Kit	\$Call
Dual DOS Switch	29.95
With Second DOS System — JDOS, RSDOS, and Booklet	69.95

MODEMS

Volkmodem 300 Baud	\$ 69.95
Signalman Mark X Autodial	123.95
Mark XII 1200/300 Baud Autodial	284.95

ALL IN-STOCK ITEMS SHIPPED WITHIN 24 HOURS. SAME DAY SHIPPING PROVIDED BY REQUEST WITHOUT ANY EXTRA HANDLING CHARGES.

******* MEGADISK SPECIAL *******

With a 10 megabyte system, you can purchase a complete IBM or PC compatible host, software and cable for only \$15.00!! P.S. Ask about the MEGAPLEXER.

IBM - PC/XT WORKALIKE

All of our computers have: 8 slot motherboard, 640K, monochrome adapter, parallel printer port, 130 watt power supply, free software — all with our full warranty.	
/PC-2 Floppy Drives - Monochrome Monitor, MS-DOS	\$1,595.00
Color system resolution - 720h x 240v, MS-DOS	\$1,995.00
5meg/XTtra - 1 Floppy Drive - Monochrome Monitor, MS-DOS	\$1,495.00
Color system resolution - 720h x 240v, MS-DOS	1,995.00
10meg/XTtra - 1 Floppy Drive - Monochrome Monitor, MS-DOS	1,795.00
XTtra - Color system resolution - 720h x 240v, MS-DOS	2,295.00
20meg/XTtra - 1 Floppy Drive - Monochrome Monitor, MS-DOS	1,995.00
XTtra - Color system, MS-DOS	2,495.00
Internal Tape Backup For Any Of Above systems Add	\$449.95

PRINTERS

Dot Matrix	
Citizen	\$ Call
Star Micronics	
Gemini 120 CPS Near letter quality	starting at \$259.95
Delta 10/15 160 CPS	starting at 424.95
Radix 10/15 200 CPS	starting at 649.95
Panasonic 1090	249.95
Daisy Wheel	
Silver Reed 440 80 Column 12 CPS	315.95
550 132 Column 19 CPS	439.95
770 132 Column 36 CPS	895.00
Olympia 132 Column 14 CPS with Form and Tractor	399.95
Apple/Franklin Printer Interface w/Graphics and Cable	84.95
Printer Cables	starting at 19.95
Printer Paper — Microperf Edge 1000 Sheets	16.95

ELECTRICAL

Surge Protectors — Line Filters — SL Waber — 6 Outlets with Switch	\$ 39.95
Uninterruptable Power Supplies	399.95

MISCELLANEOUS

Diskettes in 10 Pack	from \$ 9.95
Twoprint Switches	from 99.95
Disk Drive Cables	from 16.00
Maintenance Cleaning Kits	12.00
Parallel Printer Buffers 8K	149.95
Floppy Disk Drive Cables	
1 Drive	16.00
2 Drives	18.95
Heath/Zenith 2 Drive Cables — Shielded	24.95

80

© 1985 **SOFTWARE SUPPORT, INC.**

1 Edgell Road, Framingham, MA 01701 (617) 872-9090 Telex-383425

Hours: Mon. thru Fri. 9:30 am to 5:30 pm (E.S.T.) Sat. 10 am to 3:30 pm

SERVICE POLICY — Our Professional Technical Staff Is Available To Assist You Monday Through Saturday.

WARRANTIES — Up To One Full Year Parts And Labor. Floppy Disk Drive Power Supplies — Five (5) Years.

SERVICE — 24 Hour Turn-A-Round On All In-Stock Parts. Dealer Inquiries Invited. Call 617-872-9090

Toll Free 1-800-343-8841

Please Call For Shipping,
Handling And Insurance.

Please Call For Our Latest Price Saving Specials.

Not Responsible for Typographical Errors.
Prices and Specifications May Change
Without Notice.

Patch Work II: The Sequel

With these 13 additional improvements, TRSDOS 1.3 gets better and better.

Sometimes, a good patch just isn't enough. You improve your disk a bit, it runs a little better, and you think you'll be happy. But you aren't. You always want more.

This is what I found after I'd patched my TRSDOS 1.3 disk. I thought I was done, but after I published my 13 patches in *80 Micro* ("Patch Work," January 1985, p. 112), I received letters and telephone calls from readers asking questions and making suggestions for new patches. Building on those suggestions, I compiled another 13 patches for TRSDOS 1.3; although these are more thorough than the first bunch, they still don't create the definitive DOS.

Patch Purposes

These 13 new patches improve TRSDOS 1.3's efficiency and convenience. They let you repeat DOS commands, type DOS commands in lower- or uppercase, include comment lines in do-files, skip the password prompt and check for the Purge and Back-up commands, create a default disk name for the Format command, select a more logical default parameter for the List command, change the disk drive stepping rate, use Debug to view any memory address and the Dump command to dump any address, eliminate or shorten Basic's opening banner, alter the TRSDOS boot-up and Ready messages, change the cursor character, select a global password protection level, and display a directory listing one page at a time with a prompt to continue.

Installing the Patches

Naturally, you don't have to install all the patches; just pick the ones you want. If you want to avoid typing them anew for each disk, you can use the do-file creator program on this month's Load 80 (see p. 6). DOMAKER/BAS displays each patch, lets you select the ones you want, and creates a do-file so you can apply the patches to as many disks as you like without re-typing.

Getting Started

You install the patches with the TRSDOS Patch command. This is simple to do, but make sure your disk isn't write-protected. Start at TRSDOS Ready. Type in the desired patch, proofread it, then press the enter key to finish the command. If a patch has more than one line, be sure to enter all lines before doing anything else. For example, if a patch has three patch lines, you must enter all three lines in the order given as three separate TRSDOS commands. Do not invoke any other DOS commands until you finish all patching.

If you get an error message when installing a patch, try to determine what is wrong before continuing. Also remember that some patches don't take effect until you reboot your computer.

Patching writes new code to the machine-language system programs stored on disk. So, if you make one typographical error, you could destroy a disk in seconds. Always install a new patch on a back-up disk. Don't patch more important disks until you know the patches are working as expected.

If you've applied non-Radio Shack patches to your TRSDOS 1.3 disk, these 13 patches might not work. However, they do work with all the patches in "Patch Work."

The Patches

Since "Patch Work" contained the first 13 patches, I've begun numbering the patches presented here at 14. Figure 1 contains the code for all the patches.

Patch 14 improves the way TRSDOS 1.3 accepts DOS commands. First, it gives

you repeating DOS commands; press the enter key and the computer displays and executes your last DOS command. Second, you can enter a DOS command in lower- or uppercase letters or a combination of the two. (The computer internally converts the letters to uppercase. This patch works fine for DOS commands, but some programs and utilities may still accept only uppercase letters.)

Third, the computer will ignore any DOS command line that begins with a period. While this may sound silly, it is actually quite useful. You can now put comment lines in do-files by beginning those lines with a period. When you run the do-file, the computer displays the comment lines but doesn't try to execute them or return an error message.

This new routine does not erase the TRSDOS Ready dots. (That is where I put the new code). Therefore, you'll probably want to eliminate those dots. Patch 10 from "Patch Work" takes care of that.

Patch 15 switches the default parameter for the TRSDOS List command. Normally, TRSDOS lists files in the confusing hexadecimal (hex) format unless you use the ASCII parameter. Once you install Patch 15, TRSDOS will list files in the legible ASCII format unless you add the new Hex parameter.

Patch 16 improves the Dump command so you can dump any memory address, not just those above 5FFF hex. Patch 17 lets the Debug utility examine any memory address, not just those above 55FF hex. It can also modify code at any memory address except those in ROM. Radio Shack originally issued Patch 17 in *Microcomputer News* (February 1982, p. 21, and June 1982, p. 33) but has given permission for me to reprint it here.

Patch 18 modifies the Back-up command so it bypasses the password prompt, ignores the disk master password, and improves the Format command. Press the enter key when TRSDOS asks you to name the disk. Rather than asking again for a



System Requirements

Model III
TRSDOS 1.3

NOCONA

ELECTRONICS

MODEL 4

MODEL 6000

MODEL 12

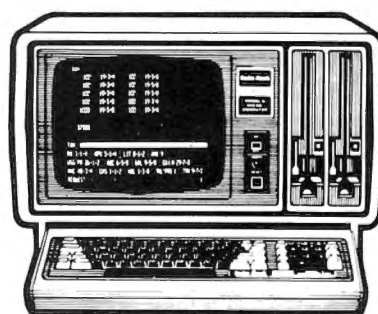
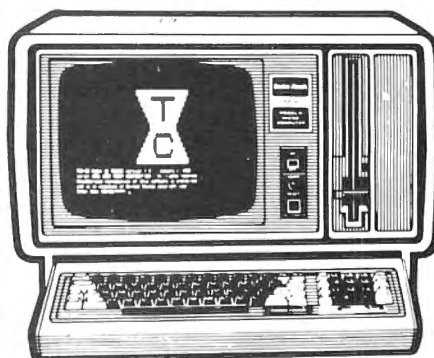
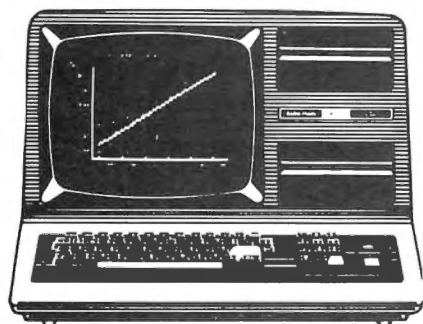

256K MOD 2000 W/MONO MONITOR ...	1319.00	CGP 220 PRINTER	499.00
256K MOD 2000 W/COLOR MONITOR ...	1649.00	DMP 105 PRINTER	145.00
256K MOD 1200 HD 1 DR.	1499.00	DMP 120 PRINTER	249.00
128K MOD 1000 W/MONO 1 DR.	839.00	DMP 430 PRINTER	585.00
128K MOD 1000 W/COLOR 2 DR.	1239.00	DMP 2100P PRINTER	1309.00
24K MOD 100 PORT	399.00	DWP 220 PRINTER	429.00
24K MOD 200 PORT	769.00	DWP 510 PRINTER	999.00
64K MOD 4 2DR.	935.00	TRACTOR DWP 220	99.00
64K MODEL 4P 2DR.	935.00	TRACTOR DWP 11/510	159.00
512K MOD 6000 2DR.	3099.00	TRACTOR FEED DMP2100P	115.00
80K MOD 12 2DR.	1199.00	PARALLEL PRINTER SWITCH	96.00
15 MEG HARD DISK	1329.00	PARALLEL PRINTER CONTROLLER ...	179.00
35 MEG HARD DISK	2059.00	70 MEG HARD DISK	2949.00
		NEW DMP 2200 PRINTER	1149.00

100% RS COMPONENTS NO FOREIGN DRIVES OR MEMORY FULL WARRANTY
ALL RS SOFTWARE 20% OFF CATALOG PRICE
CASHIERS CHECK OR MONEY ORDER MUST ACCOMPANY ALL ORDERS

(817) 825-4027

NOCONA ELECTRONICS • BOX 593 • NOCONA, TX 76255

Patch 23 affects the entire TRSDOS 1.3 password-protection scheme.

name, the program continues and names the new disk "DATADISK."

Patch 19 changes the Purge command so it no longer asks for nor cares about the disk master password.

Patch 20 augments Patch 3 of "Patch Work," which improves the Directory command so it displays directory files in the normal long format but only one page at a time. If there are too many entries for a screen, the listing pauses and waits for you to press the enter key to continue. With Patch 20 in place, a message appears at the appropriate time to remind you to press the enter key. Apply Patch 20a if you've already applied Patch 3; apply 20b if you have not. Don't apply both.

Patch 21 shortens or eliminates Basic's opening message. This is useful with a Basic program that operates under the AUTO command. Install 21a if you want to eliminate Basic's opening banner, install 21b if you want to shorten the banner so it displays only the amount of free memory and number of file buffers available. Pick one patch but not both.

Patch 22 alters the default cursor and keyboard values when you reboot the computer. Normally, TRSDOS begins with a flashing cursor set to a graphics block (ASCII value 176) and with the caps lock on. In the code for Patch 22, change the "xx" to the hex value of the cursor character you want. For example, use 5F for an underscore or C4 for the smiling face.

Change the "y" to 1 for a non-flashing cursor or to zero for a flashing cursor. Change the "z" to 1 to begin with the caps lock on, or to zero upper- and lowercase. This last setting is nice if you've applied Patch 14.

You can't install Patch 22 unless you've applied Patch 7. That patch improves the Auto command so the computer displays the name of the file you're automatically loading rather than just the message "AUTO Function Engaged." Patch 22 uses space freed up when you apply Patch 7. Remember, you can't use Patch 22 as is; change the variables to the settings you want.

Patch 23 affects the entire TRSDOS 1.3 password-protection scheme. Use it for special purposes. By only applying 23a, you can access any file on the disk regardless of password protection. By adding 23b, you'll give every file the protection level you designate, whether the file has a

✓ Patch 14
 PATCH *0 (ADD=4CD1, FIND=204E53, CHG=4E530D)
 PATCH *1 (ADD=4E32, FIND=212542112642, CHG=180B773E1BCD)
 PATCH *1 (ADD=4E38, FIND=013F003600EDB0, CHG=3300CD1B02186F)
 PATCH *1 (ADD=4E9D, FIND=E5C52A, CHG=C3BB4E)
 PATCH *1 (ADD=4EA0, FIND=2040E548060009, CHG=1A28917EFE6138)
 PATCH *1 (ADD=4EA7, FIND=014000B7ED4222, CHG=03D620772310F5)
 PATCH *1 (ADD=4EAE, FIND=20403E1ECD3300, CHG=D1E17E12FE2ECA)
 PATCH *1 (ADD=4EB5, FIND=E1222040C1E1, CHG=4A4EFE0D288F)
 PATCH *1 (ADD=4E9B, FIND=28ADC3BB4E, CHG=11D44CE5D5)

✓ Patch 15
 PATCH *11 (ADD=593E, FIND=28, CHG=20)
 PATCH *11 (ADD=5949, FIND=EDB0, CHG=0000)
 PATCH *11 (ADD=595C, FIND=28, CHG=20)
 PATCH *11 (ADD=5B89, FIND=4153434949, CHG=4845582020)
 PATCH *11 (ADD=5AC5, FIND=20, CHG=28)
 PATCH *11 (ADD=5B3C, FIND=3030303030, CHG=4153434949)

Patch 16
 PATCH *6 (ADD=5702, FIND=60, CHG=00)
 PATCH *6 (ADD=579C, FIND=D22552, CHG=000000)

Patch 17
 PATCH *5 (ADD=4EDF, FIND=38E6, CHG=0000)
 PATCH *5 (ADD=4F04, FIND=D0, CHG=C9)
 PATCH *5 (ADD=506E, FIND=38E3, CHG=0000)

Patch 18
 PATCH *7 (ADD=5013, FIND=534F55524345, CHG=FE08C0E1211D)
 PATCH *7 (ADD=5019, FIND=204469736B20, CHG=50C383564441)
 PATCH *7 (ADD=501F, FIND=4D6173746572, CHG=54414449534B)
 PATCH *7 (ADD=55A8, FIND=28, CHG=18)
 PATCH *7 (ADD=5657, FIND=21, CHG=C9)
 PATCH *7 (ADD=5673, FIND=FE0828EF, CHG=CD135000)

Patch 19
 PATCH *11 (ADD=5648, FIND=66, CHG=99)
 PATCH *11 (ADD=564D, FIND=21A25B, CHG=C36E56)
 PATCH *11 (ADD=5693, FIND=28, CHG=18)

USE THIS ONE Patch 20a (Use if you've installed Patch 3.)
 PATCH *6 (ADD=6111, FIND=0D0000, CHG=202003)
 PATCH *6 (ADD=6174, FIND=7C61, CHG=CF60)

Patch 20b (Use if you haven't installed Patch 3.)
 PATCH *6 (ADD=6111, FIND=0D0000, CHG=202003)
 PATCH *6 (ADD=616D, FIND=CD8861B7C8FE40, CHG=3A803FD620C8CD)
 PATCH *6 (ADD=6174, FIND=2806C547AF78C1, CHG=CF60CDC901AFC9)

Patch 21a (Completely eliminates Basic's opening banner.)
 PATCH BASIC/CMD (ADD=62EF, FIND=CD, CHG=C9)

Patch 21b (Shortens Basic's opening banner to one line.)
 PATCH BASIC/CMD (ADD=62ED, FIND=29, CHG=8F)

✓ Patch 22
 PATCH *0 (ADD=4E11, FIND=21F443, CHG=CD6B4F)
 PATCH *0 (ADD=4F6B, FIND=4155544F2046, CHG=3E0z3219403E)
 PATCH *0 (ADD=4F71, FIND=756E6374696F, CHG=0y321C403Exx) ← 5F
 PATCH *0 (ADD=4F77, FIND=6E20456E676167, CHG=32234021F443C9)

NO Patch 23a (Gives full or partial file access. Needed for 23b.)
 PATCH *2 (ADD=4ED4, FIND=20, CHG=18)

NO Patch 23b (For a designated global file protection level.)
 PATCH *2 (ADD=4ECB, FIND=00, CHG=0x)

NO Patch 24
 PATCH *0 (ADD=42EE, FIND=0C, CHG=0x)
 PATCH *0 (ADD=4516, FIND=0C, CHG=0x)
 PATCH *0 (ADD=4544, FIND=1C, CHG=1x)
 PATCH *0 (ADD=4FE1, FIND=0C, CHG=0x)
 PATCH *7 (ADD=580E, FIND=0C, CHG=0x)
 PATCH *7 (ADD=5841, FIND=0C, CHG=0x)
 PATCH *7 (ADD=5B3C, FIND=58, CHG=5y)

Patch 25
 PATCH *1 (ADD=509C, FIND=545253444F53, CHG=xxxxxxxxxxxx)
 PATCH *1 (ADD=50A2, FIND=205265616479, CHG=xxxxxxxxxxxx)

Patch 26
 PATCH *0 (ADD=5016, FIND=5452532D383020, CHG=xxxxxxxxxxxx)
 PATCH *0 (ADD=501D, FIND=4D6F64656C2049, CHG=xxxxxxxxxxxx)
 PATCH *0 (ADD=5024, FIND=49492054525344, CHG=xxxxxxxxxxxx)
 PATCH *0 (ADD=502B, FIND=4F532076657273, CHG=xxxxxxxxxxxx)
 PATCH *0 (ADD=5032, FIND=696F6E20312E33, CHG=xxxxxxxxxxxx)

Figure 1. Patches 14-26. Make sure you leave a space after the word PATCH.

Patch 25 lets you change the TRSDOS Ready prompt to the message of your choice.

password or not. This is useful in places such as schools where students "accidentally" destroy other students' files. Set the protection level to 5 and a student can read, list, or execute any file, as well as save it under a new name. However, the student can't kill or overwrite a file.

You can't use the patch line in 23b as is. Change the "x" to the protection level you want, from zero (full access) to 7 (no access). Do not use a protection level of 3 as TRSDOS does not fully support it. If you apply 23a alone, all files will always have full access status.

Patch 24 changes the disk drive stepping rate. TRSDOS steps all disk drives at the same rate. As distributed, that rate is 6 milliseconds (ms). Some older drives can't step that fast. To help avoid disk errors, use a slower stepping rate. Patch 24 lets you select one of the four rates permitted by the disk controller: 6, 12, 20, or 30ms. Try to use the fastest rate that doesn't give you disk errors.

Before using this patch, change the "x" to C, D, E, or F, and the "y" to 8, 9, A, or B for 6, 12, 20, or 30 ms rates, respectively. Once patched, the selected rate works for all disk drives at all times except during the system boot. TRSDOS 1.3 uses only one stepping rate for all drives. You'd have to rewrite too much system code to permit setting separate stepping rates for individual disk drives.

Patch 25 lets you change the TRSDOS Ready prompt to the message of your choice. Many people asked for this patch so they wouldn't confuse regular TRSDOS 1.3 with a modified version. This change requires some work on your part.

You must first compose your new prompt. It should consist of 12 or fewer

characters. If you use fewer than 12 characters, add spaces to bring the total up to 12. Almost any character, even a graphics block, works fine. However, you should avoid control characters (ASCII values less than 32) and all special characters (ASCII values greater than 191).

Next, convert each character in your message to a hex pair (see the table in the Model III manual). For example, the letters A and Z become 41 and 5A hex. Don't forget the spaces that convert to 20 hex.

Don't use the code for Patch 25 as listed. Instead, substitute the first six hex pairs of your message for the CHG value in the first patch line and the second six pairs as the CHG value in the second patch line. See Fig. 2a for an example of an altered prompt.

Patch 26 is similar to Patch 25, except that it modifies the message the computer displays when you boot TRSDOS. However, it gives you 35 characters to work with rather than 12. The procedure, though, is identical. Design your message, convert it to hex pairs, then use those pairs in place of the "xx" values in the five patch lines. Each line holds seven characters. Break your message into groups of seven hex pairs, then assign each in order to each patch line. Don't forget to pad your messages with spaces if your message is shorter than 35 characters.

Patch 26 only affects the message that remains after you've installed Patch 11. Patch 11 shortens the boot-up banner from a picture to just one line. You don't have to use Patch 11, but if you don't, your new boot message could get lost in the crowd.

You can't use Patch 26 as listed. Substitute the hex pairs of your message for the CHG values. Figure 2b shows the patch for a sample message. ■

Write to Andy Levinson at 11575 Sunshine Terrace, Studio City, CA 91604. Enclose a stamped, addressed envelope for a reply.

Related Article

Levinson, Andy, "Patch Work," January 1985, p. 112. Thirteen patches for TRSDOS 1.3 (Debug: March 1985, p. 27).

- ```
(a) PATCH *1 (ADD=509C, FIND=545253444F53, CHG=855061746368)
 PATCH *1 (ADD=50A2, FIND=205265616479, CHG=20576F726B8A)

(b) PATCH *0 (ADD=5016, FIND=5452532D383020, CHG=57656C636F6D65)
 PATCH *0 (ADD=501D, FIND=4D6F64656C2049, CHG=20746F20537570)
 PATCH *0 (ADD=5024, FIND=49492054525344, CHG=65726368617267)
 PATCH *0 (ADD=502B, FIND=4F532076657273, CHG=65642054525344)
 PATCH *0 (ADD=5032, FIND=696F6E20312E33, CHG=4F5320312E332B)
```

Figure 2. (a) Sample values for Patch 25. These change the TRSDOS Ready message to Patch Work. (b) Sample values for Patch 26; these change the opening TRSDOS display to Welcome to Supercharged TRSDOS 1.3+.

Circle 427 on Reader Service card.

# JOIN THE FORTH REVOLUTION

Discover the flexibility and power of FORTH programming!

You'll find your development time is shortened, programs run faster and memory requirements are drastically reduced. FORTH is the language of tomorrow and it's available today from SOTA Computing Systems Limited.

## figFORTH from SOTA

With truly impressive benchmark timings -- a library of over 300 predefined FORTH words and running in less than 8K -- this is the state-of-the-art FORTH implementation you have been waiting for!

an amazingly low price for an incredibly powerful programming system!

# \$75.00

Gives you the introductory programmer's guide, the comprehensive reference manual and FORTH disk. The diskette contains the standard core vocabulary, an editor, and assembler (with true Z80 mnemonics) and a FORTH operating system (which like FORTH itself is simple to use and easy to master). In addition to the FORTH definitions required by the standard, we've included over 50 extra commands that you'll find particularly useful. SOTA doesn't even require any expensive and awkward licensing arrangements, as long as you're not using our object code to simply re-market a FORTH system, you are free to make as many copies of the object code as you like and distribute them as you please. What's more, figFORTH from SOTA is totally compatible with TRSDOS, LDOS, NEWDOS, DOSPLUS, CP/M Plus and CP/M from Montezuma Micro.

Don't wait any longer! Free yourself from the chains of BASIC! -ORDER NOW- Join the FORTH revolution TODAY!

## ORDER FORM

Gentlemen, I'm convinced!

Enclosed is my:  check  money-order for \$75.00 (U.S. Funds).

Bill my:  VISA  Mastercard I have indicated my card number and expiry date below:

Please rush me my copy of figFORTH by SOTA for the TRS-80 computer I have indicated:

Model I  Model III  Model 4/4P

NAME: \_\_\_\_\_

STREET: \_\_\_\_\_

STATE: \_\_\_\_\_ ZIP: \_\_\_\_\_

CARD TYPE: \_\_\_\_\_ EXPIRY: \_\_\_\_\_

CARD NO: \_\_\_\_\_

SIGNATURE: \_\_\_\_\_

**ORDER TODAY** 213-1080 Broughton Street  
Vancouver, British Columbia  
Canada V6G 2A8

**(604) 688-5009**

State-of-the-Art since 1981  
**SOTA**  
Computing Systems Limited

\*TRSDOS, LDOS, NEWDOS and CP/M Plus are registered trademarks of Radio Shack, Logical Systems Inc., Apparatus Inc. and Digital Research respectively. TRS-80 is a registered trademark of Radio Shack.



# Upgraded Graphics

Add the Model 4's missing Point, Set, and Reset commands to your Basic programs.

Program Listing 1. Pixel graphics routine.

```

1 DEFINT P,R,S: PXLCODE$ = "<-----10*-----20*-----30*-----40*-----50*---
-----60*-----70*-----80*-----90*-----100*----->"
2 DATA 175,24,6,62,1,24,2,62,2,245,229,221,225,221,43,221,110,1,221,94,2,14,3,
 62,93,239,103,203,61,6,1,48,1,4,175,221,119,1,221,119,2,187,40,7,203,32,
 203,32,29,24,246,197
3 DATA 6,1,62,15,239,193,203,127,40,4,203,119,40,2,62,128,79,241,254,1,121,56,
 18,40,8,176,6,2,79,62,15,239,201,79,120,47,71,121,160,24,241,160,200,221,
 54,1,255,221,54,2,255,201
4 PXLPTR1 = VARPTR(PXLCODE$): PXLPTR1 = PEEK(PXLPTR1+1) + PEEK(PXLPTR1+2)*256
5 FOR PXLINDEX=0 TO 103: READ PXLBYTE: POKE PXLPTR1+PXLINDEX, PXLBYTE: NEXT
6 DEF FN POINT(X%,Y%) =USR 7(X% + Y%*256): DEF USR 7 = PXLPTR1
7 DEF FN RESET(X%,Y%) =USR 8(X% + Y%*256): DEF USR 8 = PXLPTR1 + 3
8 DEF FN SET(X%,Y%) =USR 9(X% + Y%*256): DEF USR 9 = PXLPTR1 + 7

```

End

Program Listing 2. Merge with Program Listing 1 for a demonstration.

```

1000 REM Title for short demo
1010 CLS: DEFINT A-Z: PRINT CHR$(15): REM Turn cursor off
1020 PRINT@ (10,22), "PIXEL4 - a POINT/RESET/SET facility"
1030 PRINT@ (11,22), "for Model 4 BASIC by Alan D. Smith."
1040 PRINT@ (12,22), STRING$(35,"-")
1050 FOR X=0 TO 12000: NEXT: CLS: REM Hold title
1060 REM Now draw grid
1070 FOR X=8 TO 152 STEP 16: FOR Y=0 TO 71: DUMMY=FNSET(X,Y): NEXT: NEXT
1080 FOR Y=2 TO 69 STEP 6: FOR X=0 TO 159: DUMMY=FNSET(X,Y): NEXT: NEXT
1090 FOR X=0 TO 6000: NEXT: CLS: REM Hold grid
1100 REM Now do box for "inversion"
1110 FOR X=50 TO 109: DUMMY=FNSET(X,17): DUMMY=FNSET(X,56): NEXT
1120 FOR Y=18 TO 55: DUMMY=FNSET(50,Y): DUMMY=FNSET(109,Y): NEXT
1130 PRINT@ (4,24), "Setting random bits via FNSET"
1140 FOR X=1 TO 500: DUMMY=FNSET(RND(58)+50,RND(38)+17): NEXT
1150 PRINT@ (4,17), "Inverting all bits via FNPOINT/FNRESET/FNSET"
1160 FOR X=51 TO 108: FOR Y=18 TO 55
1170 IF FNPOINT(X,Y) THEN DUMMY=FNRESET(X,Y) ELSE DUMMY=FNSET(X,Y)
1180 NEXT: NEXT
1190 FOR X=0 TO 12000: NEXT: CLS: PRINT CHR$(14): END: REM Turn cursor back on

```

End

Program Listing 3. Source code for Pixel's data statements.

```

00010 DIVS EQU 93 ;8-BIT DIVIDE SVC
00020 VDCFL EQU 15 ;VIDEO CONTROL FUNCTION SVC
00030 ;
00040 ; USR 7 ("POINT") ENTRY
00050 XOR A ;INDICATE "POINT"
00060 JR START ;JUMP TO COMMON START
00070 ;
00080 ; USR 8 ("RESET") ENTRY
00090 LD A,1 ;INDICATE "RESET"
00100 JR START ;JUMP TO COMMON START
00110 ;
00120 ; USR 9 ("SET") ENTRY
00130 LD A,2 ;INDICATE "SET"
00140 ;
00150 ;START BY PICKING UP INPUT ARGUMENTS (X/Y CO-ORDS)
00160 START PUSH AF ;SAVE ENTRY OPTION (0/1/2) EX A

```

Listing 3 continued

Upgrading from my trusty Model III to the Model 4 had its advantages, but I was a little disappointed to find that the TRSDOS 6.X version of Basic lacked the Point, Set, and Reset graphics commands. I could always turn screen dots on and off at the character level, but I wanted individual pixel control, which just wasn't available. So I wrote a Basic routine, called Pixel, that you can use at the beginning of any program to install the Point, Set, and Reset functions on a Model 4.

## Points of Interest

Type in Program Listing 1 and save it to disk with the ASCII option (SAVE "PIXEL",A). Now you can merge it with another program or load it into Basic before writing a new program.

In the routine, Point, Set, and Reset are defined functions that interface with a 104-byte machine-language subroutine. The syntax for calling these commands differs from the Model III's as shown below:

|           |       |         |                 |
|-----------|-------|---------|-----------------|
| Model III | POINT | Model 4 | FNPOINT         |
|           | SET   |         | DUMMY = FNSET   |
|           | RESET |         | DUMMY = FNRESET |

For example:

|            |                                 |
|------------|---------------------------------|
| Model III: | IF POINT(X,Y) THEN GOSUB 1200   |
| Model 4:   | IF FNPOINT(X,Y) THEN GOSUB 1200 |
| Model III: | SET(10,25)                      |
| Model 4:   | DUMMY = FNSET(10,25)            |
| Model III: | RESET (X,Y)                     |
| Model 4:   | DUMMY = FNRESET(X,Y)            |



## System Requirements

Model 4  
64K RAM  
Disk Basic



# There's only one newsstand in the entire world offering you this selection of great computer publications.



## You're holding it.

That's right; you can get them all here. **And at discounts.** So browse. Whether you're new to computers, an experienced home/professional user or "in the business": order yours, today!

- Computerworld.** If you manage information, you can't manage without your own subscription. \$39 gets you 51 issues, plus 10 Special Focus publications. Save \$5.
- PC World.** The one publication that will grow with your growing PC needs. Helps you analyze financial/accounting data, manage complex projects, communicate results and plan. Now 12 issues for only \$17.97; you save \$5.78.
- InfoWorld.** The only way to stay on top of what's happening is by getting the **only** personal computing newsweekly. Authoritative. Objective. Easy to read. \$29.58 for 51 issues . . . only 58¢ an issue.
- inCider.** The Apple journal . . . and the **only** magazine devoted exclusively to the Apple family of computers. \$24.97 for 12 monthly issues. Save 30% off the cover price.
- Macworld.** The world's most creative computer demands a journal that's just as simple, powerful and fun: *Macworld*. Now 12 issues of this attractive, easy-to-read publication can be yours for only \$24 (you save \$8).
- HOT CoCo.** Keep the color in your life all year long with *HOT CoCo*, the magazine specifically created for the TRS-80 color computer and MC-10 user. \$24.97 for 12 months. Save 30% off the cover price.
- 80Micro.** Don't risk being an uninformed TRS-80 user. Get current, unbiased, system-specific information from the largest, most knowledgeable TRS-80 source. \$24.97 for 12. Save 48% off the cover price.
- RUN.** The informative (and fun) Commodore 64/Vic-20 monthly. Comprehensive software/hardware reviews, action-packed games and timely tips to help you get the most out of your system. \$19.97 for one year: 43% off the cover price.
- Micro Marketworld.** Selling? Twice a month, get in-depth reviews/forecasts to keep **ahead** of consumer trends/market needs. FREE if you qualify.

**On Communications.** Bypass, teleconferencing, CATV: each month, explore the major developments shaping our communications world. FREE to qualified applicants.

### TO ORDER:

Check the publications you want above, then fill in below, and return this page to:

CW Communications/Inc.  
Circulation Department  
Box 880  
Framingham, MA 01701

Name \_\_\_\_\_  
(Please print or type.)

Title \_\_\_\_\_

Company \_\_\_\_\_

Nature of Business \_\_\_\_\_

Street \_\_\_\_\_

City \_\_\_\_\_

State \_\_\_\_\_ Zip \_\_\_\_\_

Telephone (\_\_\_\_) \_\_\_\_\_

Address shown is:  Home  Business

Bill me.

Payment enclosed (make check payable to "CW Communications/Inc.").

Send information about foreign rates.

Please allow 6-to-8 weeks for your first issue.

### Your Money-Back Guarantee

If for any reason you're ever dissatisfied with your subscription, simply request a refund for all unmailed issues.



**CW COMMUNICATIONS/INC.**

375 Cochituate Road, Box 880  
Framingham, MA 01701  
(617) 879-0700

6C09-12-EM08



Listing 3 continued

```

00170 PUSH HL ;ARGUMENT STORAGE AREA (ASA) ADDR
00180 POP IX ;TRANSFER ASA ADDR TO IX
00190 DEC IX ;ADJUST TO ENSURE NO 0'S IN CODE
00200 LD L,(IX+1) ;X CO-ORD TO L
00210 LD E,(IX+2) ;Y CO-ORD TO E
00220 ;
00230 ; CONVERT X/Y CO-ORDS TO SCREEN ROW & COLUMN
00240 LD C,3 ;DIVISOR FOR @DIV8
00250 LD A,DIV8 ;MOD4 TECH REF MANUAL (@DIV8)
00260 RST 28H ;Y/3 -> ROW IN A, REMAINDER IN E
00270 LD H,A ;ROW TO H
00280 SRL L ;X CO-ORD / 2 (= COL)
00290 ;
00300 ; CALCULATE BIT MASK WITHIN BYTE
00310 LD B,1 ;SET BIT MASK TO 01H
00320 JR NC,CLEARA ;JUMP IF NO CARRY FROM SRL
00330 INC B ;IF CARRY, MAKE BIT MASK 02H
00340 XOR A,CLEARA ;ZEROISE A FOR COMPARE
00350 LD (IX+1),A ;ZEROISE ASA FOR POINT
00360 LD (IX+2),A ; (OFF) OR ERROR RETURN
00370 ADJMSK CP E ;SHIFT COUNTER = 0?
00380 JR Z,GETCHR ;JUMP IF YES
00390 SLA B ;NO-
00400 SLA B ; ADJUST BIT MASK
00410 DEC E ;DECREMENT SHIFT COUNTER
00420 JR ADJMSK ;LOOP TILL BIT MASK OK
00430 ;
00440 ;GET CURRENT SCREEN CHAR CONTAINING REQ'D PIXEL
00450 GETCHR PUSH BC ;SAVE BIT MASK EX B
00460 LD B,1 ;@VDCTL OPTION
00470 LD A,VDCTL ;MOD4 TECH REF MANUAL (@VDCTL)
00480 RST 28H ;GET CHAR FROM SCREEN
00490 POP BC ;RESTORE BIT MASK EX B
00500 BIT 7,A ;SCREEN CHAR ALREADY GRAPHICS?
00510 JR Z,MKGRPH ;JUMP IF NO
00520 BIT 6,A ;SCREEN CHAR ALREADY GRAPHICS?
00530 JR Z,CHKOPT ;JUMP IF YES
00540 MKGRPH LD A,128 ;MAKE IT A GRAPHICS CHAR
00550 CHKOPT LD C,A ;SAVE SCREEN CHAR TO C
00560 POP AF ;RESTORE ORIGINAL ENTRY OPTION
00570 CP 1 ;CHECK WHAT IT WAS
00580 LD A,C ;(RESTORE SCREEN CHAR TO A)
00590 JR C,POINT ;JUMP IF POINT REQUIRED
00600 JR Z,RESET ;JUMP IF RESET REQUIRED
00610 ;
00620 ;SET REQUIRED
00630 OR B ;MODIFY SCREEN CHAR (SET BIT)
00640 SCRNOP LD B,2 ;@VDCTL OPTION
00650 LD C,A ;MODIFIED SCREEN CHAR TO C
00660 LD A,VDCTL ;MOD4 TECH REF MANUAL (@VDCTL)
00670 RST 28H ;RE-DISPLAY MODIFIED SCREEN CHAR
00680 RET ;BACK TO BASIC
00690 ;
00700 ;RESET REQUIRED
00710 RESET LD C,A ;SAVE SCREEN CHAR
00720 LD A,B ;BIT MASK TO A
00730 CPL A ;INVERT MASK BITS FOR "AND"
00740 LD B,A ;BIT MASK BACK TO B
00750 LD A,C ;RESTORE SCREEN CHAR TO A
00760 AND B ;MODIFY SCREEN CHAR (RESET BIT)
00770 JR SCRNOP ;GO RE-DISPLAY IT
00780 ;
00790 ;POINT REQUIRED
00800 POINT AND B ;DETERMINE POINT STATUS
00810 RET Z ;RET IF BIT OFF (ASA ALREADY SET)
00820 LD (IX+1),0FFH ;INDICATE "ON"
00830 LD (IX+2),0FFH ; (-1) IN ASA
00840 RET ;BACK TO BASIC
00850 END

```

End

Circle 34 on Reader Service card.

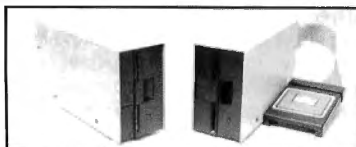

Drive 1 **139<sup>95</sup>** Your Choice Silver or White **219<sup>95</sup>** Drive 0

### SUPER DRIVE SALE

Special prices on new first quality disk drives. They even have GOLD connectors on the back...Some other places charge 279.00 for dr. 1 and 349.00 for dr. 0, not us! Drive 1 is for mod I, Second Color Computer drive, or external mod III, IV. Drive 0 is your first Color Computer drive and comes complete with controller, cable and manual. Bare drives for internal mod III, IV, only 89.95! For double-sided, add 45.00 (only for those who have DS-DOS, boards and knowledge)

#### THE COMPUTER CENTER

901-761-4565, 5512 Poplar, Memphis, TN 38119

Add \$3.90 for shipping & handling—Visa, M/C accepted—Dealer inquiries welcome

You can substitute any variable name for "Dummy," as in Z = FNSET(10,25).

For a demonstration of Pixel's graphics, merge Program Listing 2 with Listing 1 and run the merged program.

### Axis Powers

The Model III's graphics coordinates range from 0-27 horizontally and from 0-47 vertically. Pixel supports the Model 4's larger screen with more pixels, so its limits are 0-159 along the X axis and 0-71 along the Y axis. If you use values outside those ranges, the functions will do nothing or, at worst, generate an overflow error.

### The Nitty-Gritty

The key to Pixel lies in lines 2 and 3 of Listing 1. This is the machine-language code that Pixel POKEs into the string called PXLCODE\$ in line 1, and it executes there every time you use Point, Set, or Reset. By the way, use special care when you type in line 1; if the string isn't at least 104 characters long, the machine-language code won't fit.

Line 4 obtains this string's address in PXLPTR!, while line 5 sets up the code therein. Lines 6, 7, and 8 define the three new functions and their entry points.

You don't have to know anything about Assembler or machine language to use Pixel. However, if you're interested in the programming technique used here, take a look at Program Listing 3, the source for the data statements. The supervisor calls (SVCs) make it possible for TRSDOS 6.X to perform certain specialized functions. In my program, the most critical call is the @VDCTL SVC, which facilitates screen-related functions. ■

Contact Alan D. Smith at P.O. Box 119, Mortdale, N.S.W. 2223, Australia.

Circle 207 on Reader Service card.

## Scotch® Diskettes

Rely on Scotch® diskettes to keep your valuable data safe. Dependable Scotch diskettes are tested and guaranteed error-free. The low abrasivity saves your read/write heads. They're compatible with most diskette drives.



**(800)235-4137**

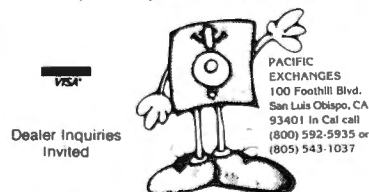



**NEW PRICES!**

**EDIT**  
Full-screen Basic editor. On-line, 30+ commands/functions.  
Reg \$40 **\$20 + \$2 s/h**

**SBE**  
Machine-code development system. Upwards compatible with PC version.  
Reg \$100 **\$50 + \$3 s/h**  
(PC \$160) **(\$90 pr.)**

**EnBase**  
Sophisticated relational dbms. Changes structure anytime, no re-blocking. Interfaces with Basic, Scripsit, VisiCalc. Works with HD, Network3.  
Reg \$140 **\$70 + \$3 s/h**

**FC**  
Full-screen all drive directory. A must for HD users.  
Reg \$25 **\$15 + \$1 s/h**

**ACCEL3/4**  
Easy-to-use Basic Compiler, huge speedups (2-200 times), accepts 25k+ programs, handles the whole Basic language.  
Reg \$99.95 **\$49.95 + \$2 s/h**

**SuperStep/EMU02**  
Fascinating Z80/6502 simulators. Terrific fun for learning, debugging.  
Reg \$40 ea. **\$25 pr. + \$3 s/h**

Programs work on TRS-80 Model I/III, MAX-80 (specify which machine), any DOS. CA add 6%

**Allen Gelder Software**

Box 11721 San Francisco, CA 94101 (415) 681-9371

## PowerSCRIPT 4.2

The state-of-the art UNIVERSAL add-on enhancement for SCRIPSIT® users!

**Now supports TRUE Model 4/4P 80 column version of SCRIPSIT**

Supports ALL released versions of SCRIPSIT® for 4/III/I.

Get the MOST from your printer!

Our PowerSCRIPT modification for SCRIPSIT (all versions) gives you everything that SuperSCRIPSIT does, except for proportional printing, but we give features that even SS doesn't have! Our files are full of letters from enthusiastic users who cannot believe how powerful little ole SCRIPSIT can become with PowerSCRIPT!(and this version adds even more features!)

With all the smarter printers out there, it doesn't make sense to use a "dumb" word processor anymore. If you notice, there are MANY word processors out there besides the ones available from TANDY. We could recommend every one of them, IF YOU WANTED TO BUY SOMETHING NEW! What if you don't want to pop another \$200 bucks for another program? What if you don't NEED another program, but you'd like a LOT of new features without relearning a WHOLE NEW SYSTEM? SCRIPSIT is a VERY good program - we just give it some horsepower and bring it up to today's standards! PowerSCRIPT gives you MANY new features, while retaining the commands you already know - at a very low price! All your previous files will, of course be compatible.

Some features that get added to SCRIPSIT via PowerSCRIPT 4.2:

- Send commands to printer to activate special formats and functions, even embedded in the middle of the line!
- Get an ALPHABETICAL Directory from within PSCRIPT and FETCH, KILL, or CHAIN, any file right from the display! No more going back to DOS!
- Keyboard can be customized for special needs or keys.
- Special characters can be generated from keyboard without using special printer codes!
- Removes protection for your own use.
- Any code from 1 through 255 can be sent to printer through special format line.
- Video PAGE FORWARD OR REVERSE at a key-stroke!
- Multiple files can be CHAINED together at print time!
- Will not crash programs protected in HIGH MEMORY.
- "END" returns to DOS READY quickly instead of rebooting operating system.
- Built-in HELP command! HELP can be modified by user.
- Optionally select line feed after carriage return.
- Support for user-definable filters included.

For Model 4/4P, III, or I (lower case only). Works with most Model I/III operating systems or TRSDOS 6.0-6.2 on the Mod 4. Will work OK with TRSDOS 2.7DD, except for DIR from PSCRIPT. Purchaser must own appropriate version of disk-based SCRIPSIT.

PowerSCRIPT 4.2 Still only \$39.95

**SuperSCRIPSIT® Users...**

**We didn't leave YOU out!**

Now you can use SuperSCRIPT on your NON-Tandy printer! Your printer will work great using our special Printer Drivers customized for your particular printer and SuperSCRIPSIT. Low priced too, so don't miss out if you have one of the printer models listed! Model 4 fully supported!

- EPSON MX-80/100 series
- EPSON FX/RX 80/100 series
- Most all EPSON "compatibles"
- Okidata 92/93 Dot Matrix
- C. Itoh 8510 Prowriter
- C. Itoh A10-20 Daisy
- C. Itoh F-10 Starwriter

All features of SuperSCRIPSIT are supported to the fullest capabilities of the printer. Easy to install at OPEN DOCUMENT screen easy to use, and no extra commands to learn!

**PowerDRIVER—Only 29.95 ea.**

**PLEASE SPECIFY PRINTER TYPE!**

# POWERSOFT

17060 Dallas Parkway, Suite 114  
Dallas, TX 75248

**(214) 733-4475**



Circle 250 on Reader Service card.

**MARYMAC INDUSTRIES INC.**

**800-231-3680**

**Radio Shack TRS-80's  
EPSON PRINTERS**

People you Trust to give you the very best!



• Lowest  
Discount  
Prices

• Reliable  
Service

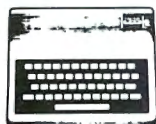
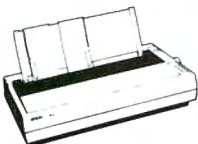

• Quality  
Products

**"World's largest Independent  
authorized Tandy Dealer"**

22511 Katy Fwy., Katy (Houston) Texas 77450  
(713) 392-0747 Telex 774132



# These Are The Best of Times

A computer's multiplication process is more involved than you might realize. A processor must execute hundreds of machine-language instructions to multiply two numbers. This month, I'll discuss how a computer multiplies numbers from a software standpoint and describe two hardware projects that illustrate multiplication methods.

I will limit my discussion to multiplying unsigned integers. While multiplying signed and floating-point numbers is more complex, it's a logical extension of unsigned integer multiplication, and the principles described below also apply.

A computer executes seven steps in multiplication:

- It stores the ASCII key values from the keyboard into a buffer area.
- It converts the ASCII number values to packed BCD format.
- It converts the packed BCD values to pure binary format.
- It does the actual multiplication with the binary numbers.
- It converts the product from binary to packed BCD format.
- It converts the packed BCD product to ASCII.
- It sends the product to the computer display, suppressing leading zeros.

I will cover only step 4 (the actual multiplication), assuming that the numbers you want to multiply are already in binary format.

## The Multiplication Algorithm

Binary multiplication is similar to decimal multiplication, though binary is more simple, since each digit of the multiplier is always either a zero or a 1. Figure 1 shows the typical decimal multiplication of 238 by 312.

|           |                   |
|-----------|-------------------|
| 3 1 2     | MULTIPLICAND      |
| * 2 3 8   | MULTIPLIER        |
| 2 4 9 6   | PARTIAL PRODUCT 1 |
| 9 3 6     | PARTIAL PRODUCT 2 |
| + 6 2 4   | PARTIAL PRODUCT 3 |
| 7 4 2 5 6 | PRODUCT           |

Figure 1. Decimal multiplication example.

|                |              |
|----------------|--------------|
| 1 1 0 (6)      | MULTIPLICAND |
| * 1 0 1 (5)    | MULTIPLIER   |
| 1 1 0          |              |
| 0 0 0          |              |
| + 1 1 0        |              |
| 1 1 1 1 0 (30) | PRODUCT      |

Figure 2. Binary multiplication example.

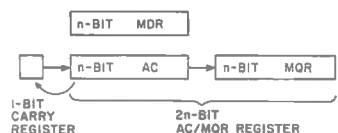

Figure 3. Multiplier register structure.

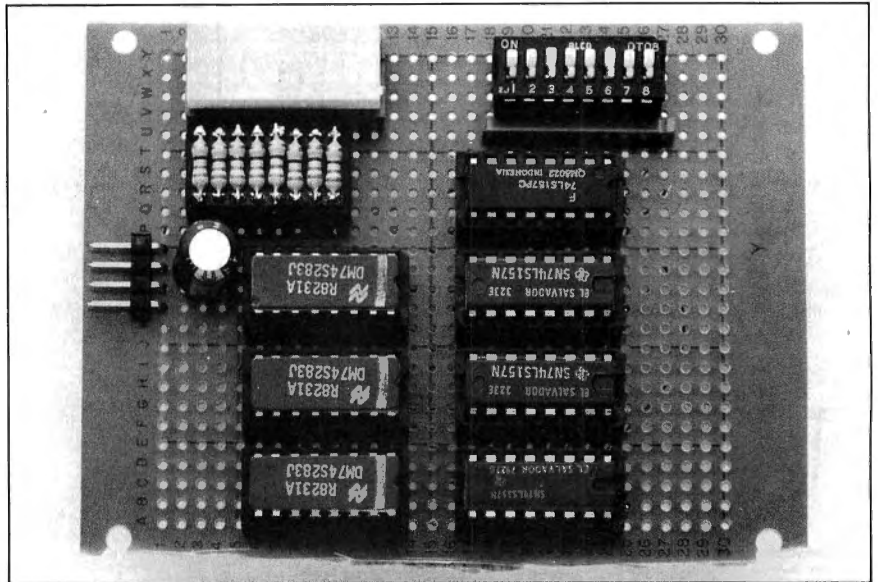

Photo 1. 4-by-4-bit sequential multiplier.

As shown, the computer first multiplies 312 (the multiplicand) by the low-order digit of the multiplier (8); it then puts this product below the line, to add it to other values later. The processor then multiplies the 312 by the next-higher-order multiplier digit (3), and puts this product below the first one, but shifts it one position to the left.

Finally, the computer multiplies the multiplicand by the high-order multiplier digit (2) and puts this product below the previously calculated products, shifted yet another position to the left.

Once the computer calculates all the partial products, it adds them together. You could consider multiplication as merely a systematic sequence of partial products, shifts, and additions. But how do you calculate the partial products? This is where the simplicity of binary

numbers makes calculations easy.

Consider the multiplication of two binary numbers (5 times 6 in decimal) shown in Fig. 2. The computer first multiplies the multiplicand (6) by the low-order multiplier digit (1), and brings the product down below the line. It then multiplies 6 by the next-higher-order multiplier digit (zero), and puts the product below the first partial product, shifted one position to the left. Finally, the processor multiplies the multiplicand by the high-order multiplier digit (1), and puts this partial product below the previous two partial products, shifted one additional position to the left. The computer then adds the partial products to get the final product.

The sequence described above continues for any additional digits that may be in the multiplier. Each partial product is



# PRINTER SALE

## THE STATE OF THE ART

The C.ITOH 3500 is fully IBM/Tandy 1000-1200-2000 compatible and FAST. Using bidirectional, logic-seeking printing across a full width of 13.2 inches, this little beauty prints at a speed of 350 characters per second (CPS). Letter quality printing is available at a rapid 87 CPS—more than twice the speed of most daisywheel printers. Couple that with a quick linefeed of 30 milliseconds per line and a standard buffer of 2K (16K optional, \$50) and you have just about the fastest throughput around. Only 4.7" high and a low noise level of 58 dBA.

Maximum versatility is offered for data and wordprocessing output, spreadsheets and business graphics by a variability of print densities, speeds, character sets and fonts, spacing, forms control and other attributes realized by operator and computer alterable functions, allowing the printer to be tailored to almost any application.

We could rave on and on about this fantastic printer but the proof is using this printer in your application. Try it on our 14 day money-back-if-not-satisfied plan. Don't be printer bound any longer. Call today.



**350 CPS only \$1995**  
(Please Specify Serial or Parallel)  
(Shipping Included)



Low Profile Design  
**ONE YEAR WARRANTY**



**\$229** (Add \$10 S & H)  
List \$299

**ProWriter™ Jr.** Near letter quality and 105 CPS for data processing. Compatible with all popular PCs. Built-in stand, easy front paper loading. The low cost answer for professional performance.

**StarWriter™ Y-10, F-10 40/55.** Daisy wheels with speeds ranging from 22 to 58 CPS for the sharpest in letter quality printing. 13.5 and 15-inch carriage widths. Switch-selectable pitches 10, 12, and 15. Compatible with all popular word processing software.



As Low As **\$899**  
(Add \$15 S & H)

- F10-40 15" wide 40cps Diablo/Qume printwheels . . . \$899
- F10-55 Fastest DW printer at 58cps 15" wide . . . \$999
- F10 Bi-Directional Tractor . . . \$199
- F10 Mechanical sheet feeder . . . \$299



As Low As **\$299**  
(Add \$12 S & H)

**ProWriter™ 8510S/1550S + NLQ Series Dot Matrix Printers.** Near letter quality, 180/120 CPS with throughput speeds of up to 110 LPM for far faster text and graphics than competitors. Models specifically designed to provide the finest performance and flexibility with IBM® and Apple®/Macintosh® microcomputers.

- 8510 BPI IBM Graphics, 120cps 10" friction/tractor . . . \$299
- 8510 SEP IBM Graphics, NLQ and faster at 180cps . . . \$399
- 8510 CEP IBM Graphics, 180cps plus 7 colors . . . \$499
- 1550 EP 15" wide 120cps friction/tractor included . . . \$499
- 1550 BCD Like above but RS232 interface . . . **SPECIAL** . . . \$299
- 1550 SEP 15" IBM Graphics NLQ and a fast 180cps . . . \$599

**ProWriter™ 24LQ.** The Ultimate Printer. 24-pin dot matrix printer. 6 printers in 1 for all professional printing needs. 200 CPS for data, 133 CPS memo quality, 67 CPS letter quality. Selectable type styles. Up to 7-color graphics at 360 x 360 DPI.



**\$999** (Add \$15 S & H)  
List \$1299

**ORDER TODAY CALL TOLL FREE 800-527-0347/800-442-1310**



# MONTEZUMA MICRO

P.O. Box 32027  
Redbird Airport, Hangar #8  
Dallas, TX 75232  
214-339-5104









## New Low Price on these GREAT TRS-80 programs!

Disk Programs only \$9.97    Cassette programs only \$8.57!

### GAMES

|                    |                |
|--------------------|----------------|
| Sparrow Commander  | (disk)         |
| Kitchen Sink       | (disk)         |
| Space Shuttle      | (cass.)        |
| Battle Ground      | (cass.)        |
| Mystery Fun House  | (cass.)        |
| Galactic Empire    | (cass. & disk) |
| Dragonquest        | (cass.)        |
| Temple of the Sun  | (cass. & disk) |
| Ball Turret Gunner | (cass.)        |
| Alien Attack Force | (cass.)        |
| Cosmic Patrol      | (cass.)        |
| Swamp War          | (cass.)        |
| House of 30 Gables | (cass.)        |
| Domes of Kilgari   | (cass. & disk) |
| Night Flight       | (cass.)        |
| Flying Circus      | (disk)         |
| Master Reversi     | (cass. & disk) |

AND MANY MORE TITLES!!

### DOLLAR DISKS!!

Nationally Known Brand!!  
 SS/DD only \$1.00 each    STOCK UP  
 DS/DD only \$1.15 each    NOW!

### TRS-80 ENCYCLOPEDIAS

Helpful and informative for your TRS-80 computer. TEN Volumes available for only \$4.00 per volume!

ORDER ALL TEN TODAY!

### UTILITIES AND EDUCATION

|                        |                |
|------------------------|----------------|
| Cassette Scope         | (cass.)        |
| Renum Compress         | (cass.)        |
| Terminal-80            | (cass.)        |
| Programmer's Converter | (cass.)        |
| Programmer's Primer    | (cass.)        |
| Disk Editor            | (disk)         |
| Disassembler           | (cass.)        |
| Geography Explorer     | (cass. & disk) |
| Typing Teacher         | (cass. & disk) |
| Investor's Paradise    | (cass.)        |
| Music Master           | (cass.)        |
| Music Teacher          | (cass.)        |
| Teacher's Aide         | (disk)         |
| The Elements           | (cass.)        |
| Astrology              | (cass. & disk) |
| Electronic Breadboard  | (cass. & disk) |
| Everyday Russian       | (cass.)        |

To Order Call NOW — TOLL FREE 800-843-6700

Ask for Operator 1107 — in N.H. call 352-3763

Terms: VISA, Mastercard, MO, Check.

Add \$3.00 for shipping/handling. U.S. funds only.

Some items are limited in quantity.

**instant Software**  
computer centers

KEENE 603-352-3736    NASHUA 603-889-0084    HUDSON 603-883-8080    BOSTON 617-353-1582    WELLESLEY 617-235-6652    ACTON 617-263-0418

Name \_\_\_\_\_  
 Address \_\_\_\_\_  
 City \_\_\_\_\_  
 State \_\_\_\_\_ Zip \_\_\_\_\_

Mail to:  
**Instant Software**  
 82 Main St.  
 Keene, NH 03431

# CUT RIBBON COST

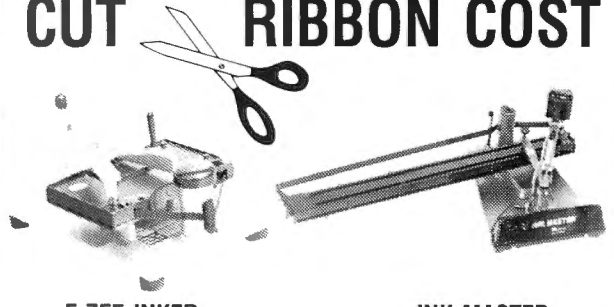

**E-ZEE INKER**  
\$39.50

**INK MASTER**  
\$159.00

Re-ink most fabric ribbons with only one machine

- Versatile
- No Fuss No Mess
- Simple to Use
- Adjustable

Stop throwing away used fabric ribbons. Re-ink them yourself with the E-ZEE INKER or INK MASTER. Re-ink almost any cartridge type fabric ribbon in only a few minutes. And you can do most reel to reel ribbons with an optional attachment. All without fuss! Without mess!

The manual E-Zee Inker is only \$39.50. For higher ribbon volumes and more versatility, choose the electric Ink Master at \$159.00. Ink cost is only a few cents per ribbon.



ORDER TOLL-FREE: 800-553-2404  
 In Iowa: 319/987-2976  
 Visa/MC accepted

# BT SPECIAL CLOSEOUT

## SPECIAL CLOSEOUT

2 user

# MULTIPLEXER (EXPANDABLE TO 4 USERS)

for Models I/III/4 includes 2 Host Adaptors

FOR: Bi-Tech Hard Drives, TANDY Hard Drives, most manufacturers

**\$795<sup>00</sup>**

**SPECIAL** with any purchase of Bi-Tech MULTIPLEXER SYSTEM.

**10 Megabyte Hard Disk** at **\$995<sup>00</sup>** complete

B.T. Enterprises  
 10 Carlough Road  
 Bohemia, NY 11716-2996  
 (516) 567-8155 (800) 645-1165

B.T. Enterprises is a division of Bi-Tech Enterprises Inc.

All prices above include 2% cash discount. Credit card customers add 2% to prices. Add \$4.00 shipping & handling on all prepaid orders. Add \$7.00 shipping & handling on C.O.D. orders.

DEPT 1 H

Mastercard/VISA

the next generation

## Bi-Tech MULTIPLEXER

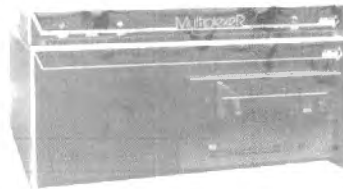

NOW SUPPORTS:

- PC COMPATIBLES
- TANDY 1000/1200/2000

### IBM PC FEATURES

- 10 megabyte removable cartridge
- multiple operating system segments
- 10-60 megabytes
- size capability variable segment
- MS-DOS Support

### MORE CLOSEOUT SPECIALS

- HOLMES VID-80/w CPM for MODEL III ..... 375.00
- HOLMES SPRINTER III ..... 95.00
- MODEL 100 MEMORY CHIPS ..... each 60.00
- EPSON JX-80 COLOR PRINTER ..... 540.00
- C-I/OH F-10 SHEET FEEDER ..... 550.00
- SUPER UTILITY 3.1 ..... 50.00
- FILTERED POWER STRIPS (6 outlet) ..... 75.00
- COMPUTER CARE KIT ..... 15.00
- **CENTECH COLORED DISKETTES 10 COLORS**
- SINGLE SIDE DOUBLE DENSITY ..... 20.00
- DOUBLE SIDE DOUBLE DENSITY ..... 25.00



tion process, until the processor can shift it into the AC. Figure 3 illustrates the multiplier register structure.

The computer multiplies values using this algorithm:

1. It puts the multiplier into the MQR and places the multiplicand into the MDR.
2. It sets a counter to n (for an n- by n-bit multiplication).
3. It clears the AC and Carry registers.
4. It determines if the low-order MQR bit is a 1. If not, it goes to step 6.
5. It adds the MDR value to the AC. It sets the Carry register if a carry occurs, and clears it otherwise.
6. It shifts the AC/MQR double-precision register right one bit position, shifting the Carry bit into the high-order AC bit position and shifting the low-order MQR bit out of the register. It also shifts a zero into the Carry register.
7. It decrements the counter. Is the counter zero? If not, go to step 4.
8. The multiplication is complete. The 2n-bit product is in the AC/MQR double-precision register.

As the algorithm indicates, the multiplication process consists of n add/shift sequences. As the computer shifts the AC/MQR double-precision register to the right, it puts the next-higher-order multiplier bit in the low-order MQR bit position, determining whether or not it should add a value during the next iteration of the algorithm.

### A Software Approach to Multiplication

Most computers do multiplication through software. It's a simple matter to type in PRINT 45\*96 in Basic and watch the result instantly appear. The Program Listing shows a Z80 Assembly-language subroutine that performs 8- by 8-bit multiplication, with a 16-bit product. The processor passes the multiplicand in the accumulator and passes the multiplier in the E register. The processor returns the product in the D/E register pair; it returns all other registers unaffected.

The subroutine follows the multiplication algorithm given above. It uses the C register as the MDR, the D register as the AC (though the actual addition takes place in the Z80's accumulator), and the E register as the MQR.

### Two Hardware Approaches To Multiplication

While the software approach to multiplication is adequate for most applications, many applications still require the increased speed of hardware multiplication. Even processors with internal multiply and divide instructions can often benefit from faster multiplication or division circuitry. While about 1 percent of the run-time instructions executed in such systems involve multiplication and

division, they typically use about 10 percent of the processing time.

Two hardware approaches exist for multiplication: the sequential multiplier and the parallel (combinational) multiplier. The sequential multiplier is by far the more common and economical. All microprocessors with internal multiplication instructions use this approach, as do math coprocessors and slave processors.

I'll discuss each of the hardware approaches below and describe a 4- by 4-bit multiplier to illustrate how they work.

### The Sequential Multiplier

The sequential multiplier implements the multiplication algorithm described above in hardware. A state machine specifies each operation of the sequential circuit. The circuit also consists of a synchronizing clock, a counter, a full-adder, and some shift registers, along with some miscellaneous support circuitry.

Figure 4 shows the schematic diagram for a 4- by 4-bit sequential multiplier (see Parts List 1). The completed circuit appears in Photo 1. You can also choose options for the oscillator (see Fig. 5). Since I designed this board for illustration, I suggest option A because it lets you single-step through the multiplication process, one clock cycle at a time. This is done by using a momentary contact SPDT button switch, the same type of switch used for the Load function. I used light-emitting diodes (LEDs) for displaying the products (see Fig. 6). Note that an LED goes on for a zero value.

You'll notice two four-position DIP (dual in-line package) switches in Fig. 4, one for the multiplier and one for the multiplicand. When you press the load button, the processor loads the multiplier into the 74LS95 shift register (used as the MQR). It also clears the 74LS195 (used as the AC) and the 74LS74 (used as the Carry regis-

| Qty. | Description                                           | Part Dist. number | Price each |
|------|-------------------------------------------------------|-------------------|------------|
| 1    | 74LS93 4-bit binary ripple counter                    | JRD 74LS93        | .55        |
| 2    | 74LS00 quad two-input and gate (LS TTL) IC*           | JDR 74LS00        | .24        |
| 2    | 74LS08 quad two-input and gate (LS TTL)               | JDR 74LS08        | .28        |
| 1    | 74LS73 dual J-K flip-flop (LS TTL)                    | JDR 74LS73        | .39        |
| 1    | 74LS32 quad 2-input or gate (LS TTL) IC               | JDR 74LS32        | .29        |
| 1    | 74LS195 4-bit parallel access shift register (LS TTL) | JDR 74LS195       | .69        |
| 1    | 74LS283 4-bit full adder with fast carry              | JDR 74LS283       | .69        |
| 1    | 74LS95 4-bit shift register (LS TTL)                  | JDR 74LS95        | .75        |
| 1    | 74LS74 dual d-type flip-flop (LS TTL)                 | JDR 74LS74        | .35        |
| 2    | 4 position dip-switch (SPST)                          | RS 275-1304       | 1.49       |
| 10   | 330-ohm resistor (.25 watt)*                          | RS 271-1315       | .08        |
| 12   | 4.7k-ohm resistor (.25 watt)*                         | RS 271-1330       | .08        |
| 2    | Momentary contact SPST pushbutton switch*             | RS 275-1549       | 2.19       |
| 10   | Red light emitting diode (LEDs)*                      | RS 276-041        | .35        |
| 1    | 47 $\mu$ F/35-volt electrolytic capacitor (PC mount)  | RS 272-1027       | .69        |
| 1    | .1-inch matrix grid prototype board                   | RS 276-158        | 1.95       |

\* Quantity shown assumes use of the single-cycle clock option.

Parts List 1. Parts for sequential multiplier

| Qty. | Description                                          | Part Dist. number | Price each |
|------|------------------------------------------------------|-------------------|------------|
| 4    | 74LS157 quad 2-to-1 multiplexer (LS TTL) IC          | JDR 74LS157       | .65        |
| 3    | 74LS283 4-bit full adder with fast carry             | JDR 74LS283       | .69        |
| 8    | 330-ohm resistor (.25 watt)                          | RS 271-1315       | .08        |
| 8    | 47 $\mu$ F/35-volt electrolytic capacitor (PC mount) | RS 271-1027       | .69        |
| 8    | Red light emitting diode (LEDs)                      | RS 276-041        | .35        |
| 2    | 4 position dip switch (SPST)                         | RS 275-1304       | 1.49       |
| 1    | .1-inch matrix grid prototype board                  | RS 276-158        | 1.95       |

JDR Microdevices, 1224 S. Bascom Ave., San Jose, CA 95128, 800-538-5000 or 408-995-5430 outside CA; 800-662-6279 inside CA.

Radio Shack (RS) National Parts Division, 900 E. Northside Drive, Fort Worth, TX 76102, 817-870-5662.

Parts List 2. Parts for combinational multiplier.



# FREE FREE FREE

## PUBLIC DOMAIN SOFTWARE

**1700 programs available for the IBM PC**

Public Domain programs are available to anyone. Programmers have placed them there to be used after deciding not to go the expensive marketing route.

**CATALOG (Disk #0)** - This disk contains not only the latest information on all disks available - but also a search, sort and update capability. So, if you're looking for spreadsheet models, games, etc., it can quickly tell you which disks they're on. **Disk - \$7.00 each**

**SPECIAL #51** - An introductory sample of 5 selected disks plus the disk catalog all for \$35! These disks include sorted directory, games, communications, spreadsheet models, music, etc.

**Interested in LISP or PROLOG? Order Disk #109.**

**ORDERING:** Minimum order - 2 disks, except catalog  
All software runs on IBM PC and compatibles. DOS 1.1, 2.0, 2.1, 3.0 or 3.1 and double-sided drives required. Programs are added monthly.

Name \_\_\_\_\_ Disk # \_\_\_\_\_  
 Address \_\_\_\_\_ Special \_\_\_\_\_  
 City \_\_\_\_\_ Calif. Res., Add \_\_\_\_\_  
 State \_\_\_\_\_ Zip \_\_\_\_\_ 7.0% Tax \_\_\_\_\_  
 Phone \_\_\_\_\_ Payment \_\_\_\_\_  
 CC # \_\_\_\_\_ Enclosed \_\_\_\_\_  
 Exp. Date \_\_\_\_\_ (\$30.00 Min. Credit Card Order) **NO COD's**  
 Signature \_\_\_\_\_ **OR PO's**

For Traceable Shipments: UPS \$5. per 10 disks — U.S. Mail \$10. per 10 disks  
 Canada & Overseas: Add \$10. Shipping

**PUBLIC DOMAIN SW**  
**3080 Olcott St. B 130, Santa Clara, CA 95054**  
**(Phone Orders) 408-988-0230**

IBM is a registered trademark of International Business Machines.

# SOFTWARE ACCESSORIES CHECKLIST

**STOR-A-BIT**

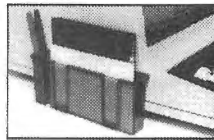

Active storage for disks & cassettes, pens & pencils. Attaches easily to your computer or typewriter with enclosed velcro kit.

**\$4.95**

**DISKFILE**

Stores up to 50 disks vertically. Dust free protection with index dividers.

Special **\$16.95** Save \$3.

**SPECIAL OFFER: STORAGE PAK OFFER**

Includes: 1 Diskfile • 1 Stor-A-Bit  
 10 SS/DD Polar • Diskettes  
 Just **\$29.95** per pak— Save **\$9.90**  
 (add \$2.50 for DS/DD)

**POLAR DISKETTES**

|              | Regular Price | SPECIAL PRICE | 10-99 BOXES OF 10 (PER BOX OF 10) | 100 & UP BOXES OF 10 (PER BOX OF 10) |
|--------------|---------------|---------------|-----------------------------------|--------------------------------------|
| 5 1/4" SS/DD | \$17.95       | \$13.25       | \$12.50                           | \$11.25                              |
| DS/DD        | 22.95         | 15.95         | 14.95                             | 13.50                                |

Manufacturer's Lifetime Warranty.  
 100% certified soft sectored with reinforced hubs

## LAMBDA

Box 756, Dover NH 03820  
 Toll Free 1-800-258-7148 in NH 742-7717  
 Credit Cards/Check/Money Order  
 add \$3.00 shipping per order  
**MONEY BACK GUARANTEE**

For Canadian Pricing & Orders, Call  
**TRINETICS LTD**  
 1-800-267-4292

# ACCOUNTING FOR MICROS

**\$325** Set of Three

**\$395** Set of Four

**\$465** Set of Five

**ACCOUNTING FOR MICROS** is a set of integrated accounting programs which meet professional standards. They're fast and easy to use, with complete instructions. Our manual (shown above) also includes helpful information on bookkeeping and computers.

**GENERAL LEDGER** ..... **\$125**  
 Allows up to 1,000 accounts & 1,000 transactions/month. Retains month-end balances for Last Year, This Year and Forecast. Includes Cash Disbursements, Cash Receipts and General Journals. Reports include Balance Sheet, Income Statement, Annual Summary, and Journal Report.

**ACCOUNTS RECEIVABLE** ..... **\$125**  
 Allows up to 2,500 customers and 1,000 invoices per month. Invoicing can access Inventory Module. Keeps customer names and addresses. Invoice prints on plain paper or any pre-printed form. Statements can be printed at any time.

**INVENTORY** ..... **\$125**  
 Allows up to 4,000 parts. Keeps 3 month history of unit sales as well as year to date. With AR, can

be used as point of sale system (prints invoices, handles cash). Reports include Inventory Value and Stock Report, Internal and Customer Price List.

**ACCOUNTS PAYABLE** ..... **\$125**  
 Allows up to 500 vendors and 600 invoices/mo. Records invoices and handwritten checks. Prints computer checks on any pre-printed form. Keeps vendor names and addresses.

**PAYROLL** ..... **\$125**  
 Will handle up to 100 employees with six deductions per employee. Deductions may be determined as fixed dollar amounts or percentages, or referred to a table for automatic look-up. Tax tables are easily entered, or purchased separately.

**RUN ON MOST CPM AND MACROS**  
 Apple CPM, IBM PC, CPC, PAT, Sanyo (all)  
 Columbia Kaypro (all), Tandy (all)  
 Compaq Morrow (all), TeleVideo  
 Corona Osborne (all), Zenith 100 & 150  
 Eagle (all), Panasonic, 8" CPM  
 Epson QX-10, Radio Shack CPM, Other compatibles

**DEMO DISK**  
**\$18.00**



Try all 5 programs above (GL, AR, AP, IN, PR). Order our DEMO DISK for \$18.00 (includes shipping). Condensed versions of the programs give you the "feel" of data entry and access. Includes sample reports and instructions. Specify machine.

SET OF FIVE ..... **\$465**  
 SET OF FOUR ..... **\$395**  
 SET OF THREE ..... **\$325**

**HOW TO ORDER:** Please specify machine and disk format. You can pay by check, by VISA or MasterCard (we need your expiration date and card number), or by UPS COD (add \$2.50 COD charge). Our price includes shipping. Minnesota residents, add 6% sales tax. We ship most orders the same day.  
 or **ORDER BY PHONE: 612-339-2521**

**James River Group**  
 INCORPORATED



125 North First Street  
 Minneapolis, MN 55401

(612) 339-2521



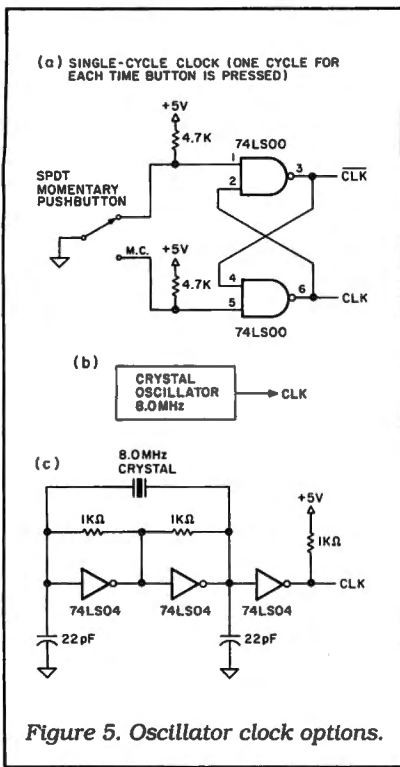

Figure 5. Oscillator clock options.

ter). When you release the button, the computer sets the A bit to indicate that it will begin multiplication. The 74LS283 4-bit full-adder does the additions, and the multiplicand DIP switches act as the MDR. Also, the 74LS93 functions as the counter. I've described the function of the 74LS157 below.

The 74LS73 J-K flip-flops are the basis of the state machine. The outputs of these flip-flops define the activity of the circuit at any given time. The three states are defined as follows:

- |    |    |                                                                |
|----|----|----------------------------------------------------------------|
| S1 | S0 | Activity                                                       |
| 0  | 0  | Idle                                                           |
| 0  | 1  | Add the output of the 74LS157 to the 74LS195                   |
| 1  | 1  | Shift the Carry/74LS195/74LS95 register right one bit position |

If you use the single-cycle clock approach, you'll find it especially helpful to connect the S0 and S1 signals to light-emitting diodes to show the current system state. At power-up, you should step the clock until you reach the 00 idle state. At this point, the computer should set the binary numbers you want multiplied on the DIP switches (a closed

switch represents a zero bit) and you should push the load button to initialize the circuit. After you release the button, the next clock cycle changes the state from 00 to 01. It takes eight clock cycles to complete the multiplication. Afterwards, the 8-bit product appears on the outputs of the 74LS195/74LS95 double-precision register and the state machine returns to idle.

The circuit deviates slightly from the multiplication algorithm given earlier. Instead of skipping the addition with a

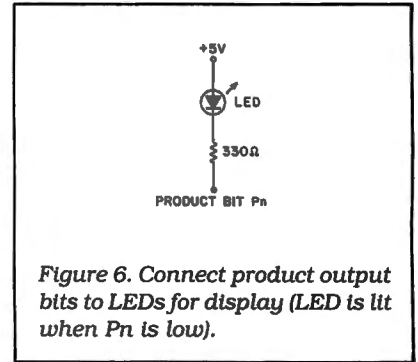

Figure 6. Connect product output bits to LEDs for display (LED is lit when Pn is low).

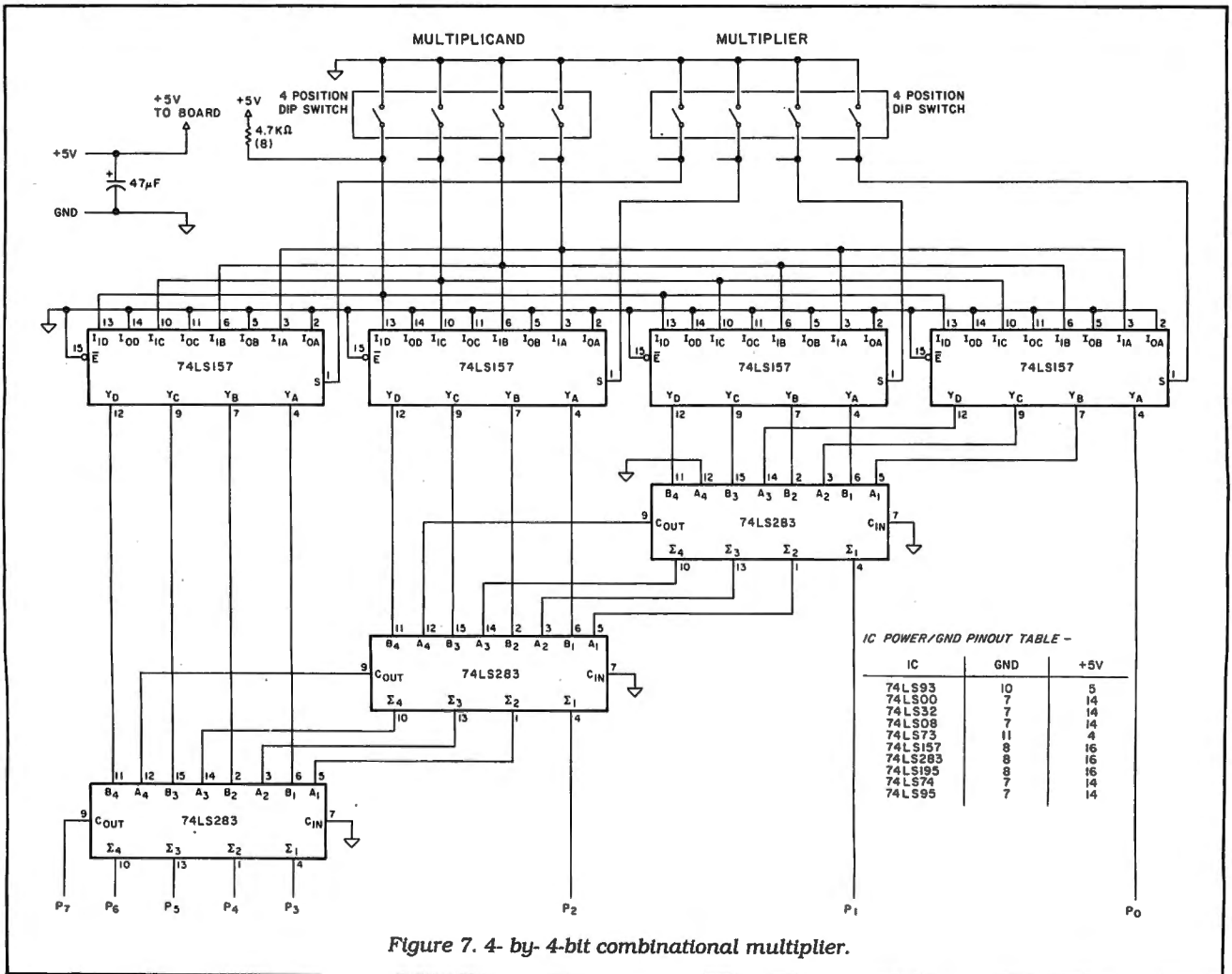

Figure 7. 4-by-4-bit combinational multiplier.

IC POWER/GND PINOUT TABLE -

| IC      | GND | +5V |
|---------|-----|-----|
| 74LS93  | 10  | 5   |
| 74LS00  | 7   | 14  |
| 74LS32  | 7   | 14  |
| 74LS08  | 7   | 14  |
| 74LS73  | 11  | 4   |
| 74LS157 | 8   | 16  |
| 74LS283 | 8   | 16  |
| 74LS195 | 8   | 16  |
| 74LS74  | 7   | 14  |
| 74LS95  | 7   | 14  |



## REAL QUALITY AT LOWER PRICES

**VERBATIM DATALIFE 5 1/4" DISKETTES—LIFETIME GUARANTEE**  
**FREE Color Coder Library Case with every box of 10**

DS1801 (10) SSDD Write protect & Hub Ring ..... \$17.95  
 DS2801 (10) DSDD Write Protect & Hub Ring ..... \$19.95

### INTRODUCING THE SRW COLOR CODER:

Complete diskette filing system by color (holds 10 ea.)  
 CC5CB (5) COLORBURST  
 (Grey, Red, Yellow, Green, Blue) ..... \$16.95  
 CC5CL (5) CLASSIC (Black, Beige, Red, Blue, Grey) .... \$16.95

### FLIP-N-FILE... THE ORIGINAL

YV3FLIP Holds 25 3.5 Micros ..... \$12.95  
 YV5FLIP Holds 50 5 1/4" Diskettes ..... \$19.95  
 YV8FLIP Holds 50 8" Diskettes ..... \$34.95

### CONTINUOUS FEED LABELS—1, 2, 3, or 4 across

1000... \$4.95      5000... \$14.95      10,000... \$24.95  
 20,000... \$46.95      All labels are 3 1/2" x 15/16" (othersizes in catalog)

### DATASHIELD SURGE PROTECTORS

SP75 4 Sockets, on/off switch ..... \$49.95  
 SP85 6 Sockets, Super Filters, on/off switch ..... \$69.95  
 SP100 6 Sockets, Super Filters, Low Voltage Alarm ..... \$75.95

### COMPUTER PAPER—"Clean Edge" 9 1/2" x 11"

(Trims to 8 1/2" x 11")  
 CP120PP 20 lb. White 250 sheets ..... \$9.95  
 CP120MP 20 lb. White 1000 sheets ..... \$24.95  
 CP120DP 20 lb. White 2500 sheets ..... \$39.95

WE CARRY A COMPLETE LINE OF RIBBONS, BACKUP POWER SUPPLIES, COMPUTER FURNITURE, AND OTHER ACCESSORIES.

## TLC COMPUTER PERIPHERALS

3161 STONE CREEK LANE  
 GRAPEVINE, TX 76051  
 (214) 450-4874

\$10.00 Minimum order  
 Texas Residents Add 5.25% sales tax  
 Shipping-add 7% plus \$1.75 insurance  
 Call or write for Free Catalog.



# CONVERT YOUR TRS-80 MODEL III OR 4 INTO A DEVELOPMENT SYSTEM

Now you can develop Z-80 based, stand-alone devices such as games, robots, instruments and peripheral controllers, by using your TRS-80 as a development system. The DEVELOPMATE plugs into the expansion connector of your TRS-80 and adds **PROM PROGRAMMING** and **IN-CIRCUIT-EMULATION** capabilities to your system.

Complete instructions and sample schematics are included to help you design your own simple stand-alone microcomputer systems. THESE SYSTEMS CAN BE AS SIMPLE AS FOUR ICs: one TTL circuit for clock and reset, a Z-80, an EPROM, and one peripheral interface chip.

When the In-Circuit-Emulation cable is plugged into the Z-80 socket of your stand-alone system, the system becomes a part of your TRS-80: You can use the full power of your editor/assembler's debug and trace programs to check out both the hardware and the software. Simple test loops can be used to check out the hardware, then the system program can be run to debug the logic of your stand-alone device.



Since the program is kept in TRS-80 RAM, changes can be made quickly and easily. When your stand-alone device works as desired, you use the Developmate's PROM PROGRAMMER to copy the program into a PROM. With this PROM, and a Z-80 in place of the emulation cable, your stand-alone device will work by itself.

The DEVELOPMATE is extremely compact: Both the PROM programmer and the In-Circuit-Emulator are in one small plastic box only 3.2" x 5.4". A line-plug mounted power supply is included. The PROM programmer has a "personality module" which defines the voltages and connections of the PROM so that future devices can be accommodated. However, the system comes with a "universal" personality module which handles 2758, 2508(8K), 2716, 2516(16K), 2532(32K), as well as the new electrically alterable 2816 and 48016(16K EEPROMs).

The COMPLETE DEVELOPMATE 83 with software, power supply, emulation cable, TRS-80 cable, and "universal" personality module, is ONLY \$329!

PM2 PERSONALITY MODULE for 2732A EPROM ..... \$15  
 PM3 PERSONALITY MODULE for 2764 EPROM ..... \$15

### ORION INSTRUMENTS

702 Marshall Street #614  
 Redwood City, CA 94064  
 415-361-8883

MasterCard and Visa phone orders accepted.  
 California residents please add sales tax.

# AT LAST RUN SIDEKICK ON TANDY 2000

WITH

## - SK 2000 -

SK 2000 is a file modification program which will allow you to RUN SIDEKICK on your TANDY 2000.

SK 2000 adds a new feature too, full color control within SIDEKICK.

Works with LOTUS, dbase II, WORDSTAR, BASIC, etc. Send \$20.00 for SK 2000 including first class airmail, Money order, Draft cheques to:

Said Alayli  
 P. O. Box 224  
 ABU DHABI - U. A. E.  
 Tel. : 09712 - 477 - 570



low-order MQR bit of zero, the computer switches the outputs of the 74LS157 to the value zero (instead of the multiplicand value) and then adds zero to the current 74LS195 value; it also clears the Carry register (74LS74).

The algorithm given earlier would require at most  $n$  (but generally fewer) additions for the multiplication. In the circuit in Fig. 4, however, the algorithm always makes  $n$  additions, though sometimes it adds only the value zero.

It would, of course, be better to include the additional circuitry needed to follow the algorithm given earlier precisely, since this would take fewer clock cycles (on the average) and since speed is the name of the game. For illustrative purposes, however, the circuit in Fig. 4 works well.

### The Parallel Multiplier

The parallel multiplier approach is much faster than the sequential multiplier although the parallel system requires more circuitry (see Photo 2). This approach involves the use of combinational logic and requires no synchronization clock. This approach merely extends the multiplication algorithm using additional hardware for the successive shifts and additions, instead of doing these operations sequentially.

Figure 7 shows the schematic for a 4-by 4-bit parallel multiplier (see Parts List 2). As shown, it has four 74LS157 quad 2-to-1 switches at the top. The inputs to each of these switches are identical, except the select (S) inputs, on pin 1. Each select input connects to a bit of the multiplier, with the low-order multiplier bit selecting the far right 74LS157 input, and the high-order multiplier bit selecting the far left 74LS157.

When the select input is high (a 1) the multiplicand value appears at the outputs of the '157; when the select input is low (a zero), the value zero appears at the outputs of the '157. The low-order bit of the low-order '157 is bit zero of the product (P0). The 3 high-order bits go into a 74LS283 4-bit full-adder. The output of the second '157 also goes to the '283, and their sum appears at the output of the '283. The low-order sum bit is then bit 1 of the product (P1), and the three high-order sum bits, plus the carry, go into the next '283, along with the outputs of the next '157. This process continues through the third full-adder, which provides the 5 high-order product bits.

You should note how the output of one stage is the input to the next stage, which the processor shifts left one bit position. Since there is a full-adder at each stage, the computer makes shifts and adds by the logic configuration. The multiplication time, then, results from

### Program Listing. Subroutine for an 8- by 8-bit multiplication with a 16-bit result.

```

00100 ;*****
00110 ; This subroutine performs an 8 X 8-bit multiplication *
00120 ; giving a 16-bit result. The multiplier is passed in *
00130 ; the E register, and the multiplicand is passed in the *
00140 ; A register (accumulator). The 16-bit product is *
00150 ; returned in the DE register pair. All other Z80 *
00160 ; registers are returned unchanged. The register usage *
00170 ; is as follows: *
00180 ; B register --> acts as the loop counter. *
00190 ; C register --> acts as the MDR. *
00200 ; D register --> acts as the AC. *
00210 ; E register --> acts as the MQR. *
00220 ; Carry flag --> acts as the Carry register. *
00230 ; Note that all additions actually take place in the *
00240 ; Z80's accumulator. *
00250 ; *
00260 ; Written by: Roger C. Alford *
00270 ;*****
FF00 00280 ;
 00290 ORG 0FF00H
 00300 ;
FF00 C5 00310 MLTPLY PUSH BC ;SAVE THE BC REGISTER
 00320 ; ; PAIR TEMPORARILY ON THE
 00330 ; ; STACK.
 00340 LD C,A ;PLACE THE MULTIPLICAND
 00350 ; ; INTO THE C REGISTER,
 00360 ; ; USED AS THE MDR.
FF02 0608 00370 LD B,8 ;SET THE LOOP COUNTER FOR
 00380 ; ; 8 ITERATIONS, SINCE WE
 00390 ; ; ARE DOING AN 8 X 8-BIT
 00400 ; ; MULTIPLICATION.
FF04 1600 00410 LD D,00H ;CLEAR THE D REGISTER,
 00420 ; ; USED AS THE AC.
FF06 B7 00430 MPLYLP OR A ;CLEAR THE CARRY FLAG
FF07 CB43 00440 BIT 0,E ;IS THE LOW-ORDER MQR BIT
 00450 ; ; SET?
FF09 2803 00460 JR Z,NOADD ;IF NOT, DO NOT ADD --
 00470 ; ; BRANCH BELOW FOR THE
 00480 ; ; DOUBLE-PREC. SHIFT.
 00490 LD A,D ;OTHERWISE ADD THE MDR
 00500 ; ; TO THE CURRENT AC.
 00510 ; ; FIRST PLACE THE AC
 00520 ; ; VALUE INTO THE Z80'S
 00530 ; ; ACCUMULATOR.
FF0C 81 00540 ADD A,C ;ADD THE MDR VALUE TO THE
 00550 ; ; AC VALUE. THE CARRY
 00560 ; ; ALSO REFLECTS THE CARRY
 00570 ; ; CONDITION.
FF0D 57 00580 LD D,A ;PLACE THE NEW AC VALUE
 00590 ; ; BACK INTO THE D (AC)
 00600 ; ; REGISTER.
FF0E CB1A 00610 NOADD RR D ;DO A DOUBLE-PRECISION
 00620 ; ; RIGHT SHIFT. FIRST
 00630 ; ; ROTATE THE AC REGISTER,
 00640 ; ; WITH THE CARRY GOING
 00650 ; ; INTO AC BIT 7. AC BIT
 00660 ; ; 0 GETS PLACED INTO THE
 00670 ; ; CARRY REGISTER.
 00680 ; ; NOW COMPLETE THE SHIFT,
 00690 ; ; BY ROTATING THE CARRY
 00700 ; ; INTO MQR BIT 7, AND
 00710 ; ; MOVING ALL OTHER BITS
 00720 ; ; DOWN.
 00730 DJNZ MPLYLP ;DECREMENT THE COUNTER.
 00740 ; ; IF NOT YET ZERO, LOOP
 00750 ; ; AGAIN TO 'MPLYLP' FOR
 00760 ; ; THE NEXT ITERATION.
 00770 LD A,C ;PLACE THE MULTIPLICAND
 00780 ; ; BACK INTO THE Z80'S A
 00790 ; ; REGISTER FOR RETURNING.
FF15 C1 00800 POP BC ;RESTORE THE BC REGISTER
 00810 ; ; PAIR FROM THE STACK.
 00820 RET ;MULTIPLICATION DONE --
 00830 ; ; RETURN TO THE CALLING
 00840 ; ; ROUTINE.
 00850 ;END OF SUBROUTINE: MLTPLY.
 00860 END
0000

```

merely the propagation delays through the chips. Using LS devices, the typical multiplication time is around 50 nanoseconds. This time drops to just a few nanoseconds when you use high-speed logic.

While the sequential multiplier circuit is more complex than the parallel multiplier, it is more useful with practical word sizes (e.g., 16- by 16-bit multipliers). The sequential circuit would require wider shift registers and a wider adder (and a carry look-ahead genera-

tor). The parallel multiplier, however, not only requires wider switches and adders, but many more of them ( $n$  2-to-1 switches and  $n-1$  adders). You can, however, get parallel multiplier chips from companies like TRW. ■

Write to Roger C. Alford at Wash-  
tenaw Digital Systems, P.O. Box 2014,  
Ann Arbor, MI 48106. Please include a  
self-addressed, stamped envelope for a  
reply.



# TRS-80 DISCOUNT

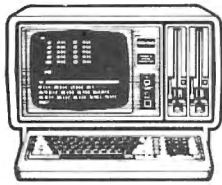

**Computers  
at Guaranteed  
Low Prices\***

**ATON CP/M FOR II, 12, 16**

**EPSON & NEC PRINTERS**

**DYSAN DISKETTES**

**HAYES MODEMS**

**Desert Sound, Inc.  
of California**

**1-800-835-5247**

**Factory Authorized Dealer**

TRS-80 is a Reg. Trademark of Tandy Corp.

**\*Call for FREE CATALOG  
and Price Guarantee**

Calif. Res. Call 619-244-6883

# You're in Good Company When You Program in BetterBASIC



BetterBASIC features include: 640K, STRUCTURED, MODULAR, INTERACTIVE, EXTENSIBLE and COMPILED. Prices: BetterBASIC: \$199; 8087 Math Module: \$99; Runtime System: \$250; Sample Disk: \$10.

Summit Software Technology, Inc.™ 1-800-225-5800

P.O. Box 99, Babson Park, Wellesley, MA 02157.

In Canada: 416-469-5244

MasterCard, VISA, P.O. Checks.

Money Orders and C.O.D. accepted.

BetterBASIC is a registered trademark of Summit Software Technology, Inc. IBM PC and IBM PC/XT are registered trademarks of International Business

## Better BASIC™

Machines Corp. Tandy is a registered trademark of Tandy Corp. Illustrated above are registered trademarks of the following companies: Mobil Oil Corp. AT & T, General Electric Co., Westinghouse Electric Corp., TRW, Inc.

ALSO AVAILABLE FOR THE TANDY 1000, 1200 AND 2000

## ADD THE PICDISC™ TO YOUR PORTABLE\* AND GET DESK TOP COMPUTER PERFORMANCE

### SOFTWARE FEATURES:

- The industry standard CP/M 2.2™ operating system, which provides for access to all popular CP/M based software (including dBASEII™, Supercalc™, and T/Maker™).
- Complete Utilities Package includes:

Filer — A menu driven LOAD/STORE program for transferring individual files (or total memory) to disc

Modem — Public domain communications package (both terminal and disc file transfer modes)

Utilities — DISKCOPY, COPY, FORMAT, and CP/M Utilities.

### HARDWARE FEATURES:

- Lightweight (4.5 lb.) battery powered 3.5 inch micro-floppy system.
- 360K bytes/diskette (same as on the IBM PC).
- Approximately 20 hours on a single battery charge assuming normal disk access.
- 32K bytes additional RAM in the PICDISC — converting your portable to a 64K byte CP/M 2.2 microcomputer.
- Includes all cables, mounting hardware and battery charger.

Complete Hardware/Software System described above — Only \$599

### SAVE ON POWERFUL INTEGRATED SOFTWARE

— when purchased with PICDISC:

T/Maker — an integrated software package that provides:

- Word Processing
- Spelling Checker with a 50,000 word Dictionary
- Spreadsheet
- Relational Database Manager

Complete System above with T/Maker for \$799 (T/Maker sold separately for \$300)



\*Immediately available for the TRS-80 Model 100 (portable must have 32K bytes RAM) and the NEC8201 and OLIVETTI OM-10 pending FCC approval.

Call or write: **PERSONAL INTEGRATED COMPUTERS (PIC)**

18013 SkyPark Circle, Ste. D., Irvine, CA 92714 (714) 261-0503



# Tracking MS-DOS: The 1000 and Other Species

I didn't name this column. In fact, I didn't like the idea. I am, after all, a modest person. I argued with my boss. I even appealed to his self-interest, pointing out that he could never get rid of me as long as the column continued. "I can always find another guy named Dave," he replied.

The subject is Tandy's MS-DOS machines. I'll focus on the 1000, because I use one and am comfortable with it, but I'll also discuss the 2000. The 1200 will receive the least treatment because it's the most IBM PC-compatible and has the fewest idiosyncracies. In spite of the title, I'll range beyond MS-DOS itself, and cover such topics as GW-Basic and commercial software and hardware.

I'll provide hints, tips, and advice that will help you get more out of your machine and, perhaps, give you some intellectual satisfaction. I'll discuss both Basic and 8088 Assembly-language programming. I'll also pass along my experiences with significant and interesting MS-DOS products. For instance, I'm eager to find out how the MS-DOS version of Powersoft's Super Utility compares with the Norton Utilities.

I expect to spend much of my time experimenting and playing. However, I'm hoping that *80 Micro* readers will provide much of the material that goes into the column. Your problems, suggestions, and hints will be my guidelines. What information do you need? What bugs are driving you crazy? What products impress you the most? I'll try to solve some problems, but I also expect to hear from readers who have solutions to pass on. I can't provide financial reward for hints and patches, but I'll give you credit in print.

## Printer Praxis

In my June article on the Model 1000 ("The Tandy 1000 Tip Sheet," p. 38), I reported that the Okidata Microline 80

## System Requirements

**Models 1000, 1200, and 2000**  
GW-Basic



Program Listing 1. A sample Assembly-language routine written with Debug.

```
N SCREEN.COM
A
MOV AX,0600 ;SCROLL UP, BLANK ALL
MOV CX,0000 ;UPPER LEFT CORNER OF SCREEN
MOV DX,184F ;LOWER RIGHT CORNER OF SCREEN
MOV BH,1F ;BRIGHT WHITE ON BLUE BACKGROUND
INT 10 ;BIOS VIDEO INTERRUPT
MOV AH,4C ;TERMINATE PROCESS
INT 21 ;DOS FUNCTION CALL INTERRUPT

RCX
ll
W
Q
```

End

Program Listing 2. A demonstration of the Sound statement.

```
10 CLS : SOUND ON : PLAY "MF"
20 ON KEY(13) GOSUB 110
30 ON KEY(14) GOSUB 130
40 ON KEY(15) GOSUB 150
50 ON KEY(16) GOSUB 170
60 FOR I = 13 TO 16 : KEY(I) ON : NEXT I
70 T = 200 : V = 1
80 SOUND T,1,V
90 LOCATE 10,35 : PRINT RIGHT$(" " + STR$(T),5);
100 GOTO 80
110 T = T + 15 : IF T > 16000 THEN T = 16000
120 RETURN
130 V = V - 1 : IF V < 1 THEN V = 1
140 RETURN
150 V = V + 1 : IF V > 15 THEN V = 15
160 RETURN
170 T = T - 15 : IF T < 1 THEN T = 1
180 RETURN
```

End



# Star demonstrates how to build up your spreadsheet figures without pumping up your budget.

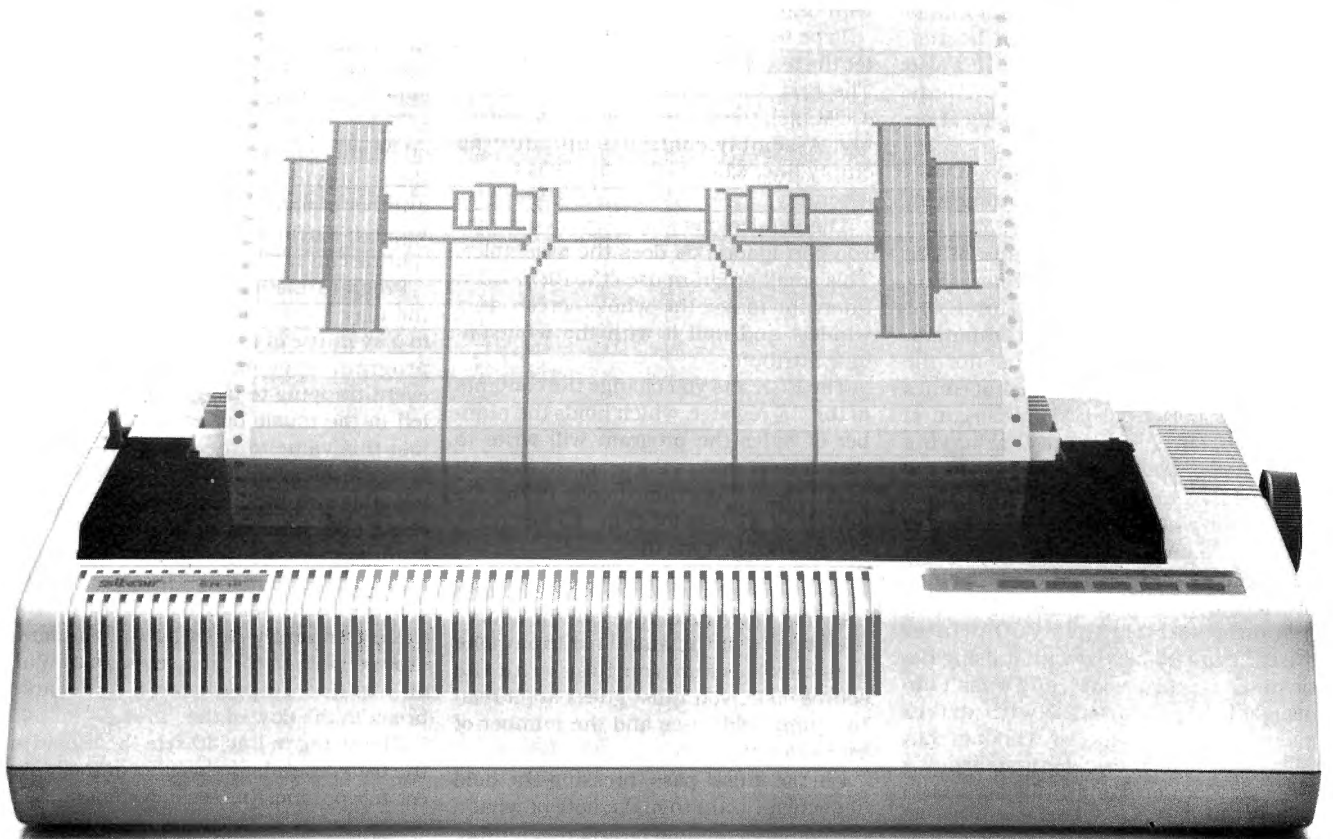

**W**atch those numbers work out! With Star's beefed-up business printers you'll see a physical difference in your figures.

For strength of characters, there's the outstanding near-letter-quality printing of our "S" series. Just flip a switch and each "S" printer kicks into a faster speed that changes from NLO to draft. Every letter and number, in either mode, in excellent shape. It's a standard feature you'd pay extra for elsewhere.

Plus, with the muscle of our

20% increased throughput, these Star printers don't take breaths. They can print on and on using up to an unbeatable 16K memory for storage.

Now, if nothing less than letter-quality definition will do, there's the classic PowerType™ daisy-wheel printer. Or the SB-10,™ Star's letter-quality printer built with a second mode for high-speed draft and full graphics capability.

And of course every printer has Star's hefty one year warranty. And very lean price.

A powerful printer and a trim budget. Now that's the shape you should be in.

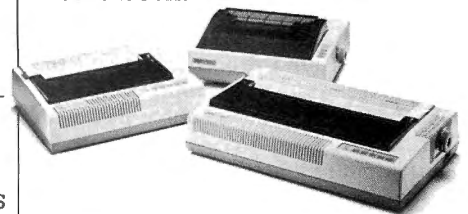

**star** 

THE POWER BEHIND THE PRINTED WORD®  
200 Park Avenue, New York, NY 10166  
Chicago, IL (312) 773-3717 • Boston, MA (617) 329-8560  
Irvine, CA (714) 586-8850



*Program Listing 3. A demonstration of the Play statement.*

```

10 ON PLAY(2) GOSUB 1000
20 PLAY ON
30 PLAY "MBMST25502EFBA"
50 PRINT "Just for Show ";
60 GOTO 50
1000 PLAY "EFBAEFBAEFBAEFBAEFBA"
1010 RETURN

```

End

blew out the 1000's printer port. I subsequently received a fix from Jay Wyrick of Hollywood, FL. If you're comfortable wires on your printer's circuit boards, the modification is easy to make. It's also the method Okidata suggests. Tandy service centers can do the modification for you, too.

You eliminate the offending high voltages on pins 34 and 36 by cutting wire S6 and a lead to resistor R17. You can see both points from the back of the printer, to the left of the Centronics plug opening. Supposedly, the printer will function as usual with other computers.

I've heard of at least one use for the printer driver (LPDRVR.SYS) that comes on the 1000 DOS disk. Tom Siriani of Hillsboro, OR, discovered that having this driver installed as a device in the CONFIG.SYS file solved the "Out of paper" error when printing lines longer than 80 columns in Basic. (The other known solution is to use the Width statement; e.g., Width Print 255.)

Should you use the 1000 printer driver? I don't; I played with it using Basic to send control codes, and wasn't impressed. The DMP-120 with driver installed acted just like my Okidata 82A with or without the driver installed. It's definitely doing something because I could print and list lines longer than 80 columns with either printer.

I would be interested to hear from anyone who finds the driver useful. You can replace codes in its character translation table from Basic or from machine language (with an INT 17H, the Basic input/output system (BIOS) printer interrupt).

## People's Assembler

If you can't afford an assembler and would like to try machine language, you already have the tools, EDLIN and Debug. This is how I've been managing; the small assembler in Debug is fine for short routines. I write source files with EDLIN (or a word processor) and use input/output redirection to force Debug to assemble the source file to an object file.

You can write Assembly-language code right in Debug, on the fly, but the trick is to have it assemble from a file that you can edit later. The text file must have all the keystrokes you would normally use in an assembling session with

Debug. Program Listing 1 is a small program that changes the screen to blue with bright white letters.

Type in EDLIN SCREEN.SRC and enter the text as listed, even the blank line. The first line names the output file (a .COM file), the second line starts assembly. Assembly continues up until the empty line, whose sole purpose is to end assembly.

The semicolons start comments that you can ignore, as does the assembler. This small program uses the BIOS video interrupt to set the whole screen as a window and null it with the white-on-blue attribute.

The RCX lets you change the contents of the CX register, which holds the number of bytes the program will write to disk. The W makes the program write all 11H bytes of assembled code to the file Screen.COM. Q is for Quit. To assemble the source file, type in:

```
DEBUG<SCREEN.SRC
```

Debug takes its input from the source file instead of the standard input (the keyboard). When you first write the source code, you must guess at all relative jump addresses and the number of bytes to put in CX.

I make a first pass, pressing the hold key when I want to make note of what a jump address should be and the number of bytes involved. I then edit the source file and reassemble. With complex routines, I make several passes, especially if a relative jump instruction suddenly becomes a byte longer. Then I have to debug.

## Basic Sounds

I was experimenting with the GW-Basic Sound statements recently. You definitely need to learn a few things if you're used to the Sound statement on the Model 4 or 2000. The 1000's Basic sound has a range of 110 Hz to above hearing with adjustable volume on three voices (like the late PCjr). The Tandy 1000 Basic manual has the value ranges and polarities for the tone and duration parameters mixed up or just wrong. (The more I use this manual, the madder I get.)

Program Listing 2 demonstrates the abilities of the Sound statement. The up-

and down-arrow keys raise and lower the tone, while the left- and right-arrow keys lower or raise the volume (on the 1000 only). The program displays the present tone value in the middle of the screen. The arrow keys act through On Key event-trapping (see 1000 Basic article). The Sound On in line 10 is necessary. The "MF" puts the sound in the foreground.

On the 1000, you also get a Noise command (six types) and the Play command. The Play statement takes a string argument with up to 32 notes or rests. The variety of string arguments provides flexibility, and Tandy implemented them so that musicians can feel comfortable using them. You can play music as a background task while a program does other things. To facilitate this process, Basic provides event-trapping for the number of notes left in the music buffer. When it's near empty, an interrupt subroutine can refill the buffer.

Program Listing 3 shows how to use the Play statement with event-trapping to play music in the background as other program lines execute. Line 10 sets event-trapping to trigger with two notes left in the music buffer. You should adjust this value to the complexity of the foreground task. If it involves uninteruptable graphics that take a while to execute (like filling a large area with the Paint statement), you'll want to set the buffer trip level higher. However, setting the On Play() parameter higher means more frequently interrupting the foreground task. In the present case, a value of 1 in line 10 produced a noticeable break in the flow of the "music."

The string in line 30 sets the music in the background, as staccato, at the highest tempo and the second octave, then starts things off with the notes E, F, B, and A. The subroutine replenishes the music buffer with several repetitions of these four notes; they repeat endlessly while the screen fills with the text in the loop from lines 50-60. When the subroutine is active, screen printing halts momentarily, but the music plays without pause.

## Program Protection

How much can you protect Basic programs from tampering or copying? The Save command has a protect option (Save "File",P) that saves a Basic program in an encoded binary format. The file is then protected from tampering, as you can't list, edit, or merge it. You can, however, load, run, or chain the program, as well as copy it. What more can be done?■

You can write to Dave Rowell at 80 Micro, 80 Pine St., Peterborough, NH 03458.



GT ENTERPRISES  
COMPUTER DISKETTES

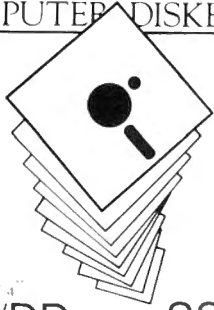

5.25"  
DS/DD  
\$.99 each

5.25"  
SS/DD  
\$.90 each

**LIFETIME GUARANTEE**

Individually Tested. 100% Error Free  
Reinforced Hub Rings Write Protect Tabs  
Color ID Labels and Tyvec Envelopes Included

Add \$3.00 shipping per 100 or fewer diskettes  
WA Residents add 8% sales tax

PHONE ORDERS  
C.O.D. MasterCard & Visa Accepted

MAIL ORDERS  
Certified Checks & Money Orders receive immediate processing  
Personal Checks allow 3 weeks to clear

GT ENTERPRISES  
2400-SW 325th Street, Federal Way, WA 98023  
24 HOUR PHONE (206) 838-5107

Computer Stores ask about our wholesale and private labeling services

# CONVENIENCE?? WHY NOT? YOU'RE WORTH IT!

**TABCO PARALLEL Printer Switch**  
connect 2 printers to one computer!  
PSM-C/2P—Manual printer switch. Prolongs the life of your printer/interface connectors. Saves time & money! Use your existing printer cable to connect TAB SWITCH to your computer. Comes complete with two 3.5' cables to connect your printers. Straight-forward design makes it easy to set-up & use. 1 year limited warranty.

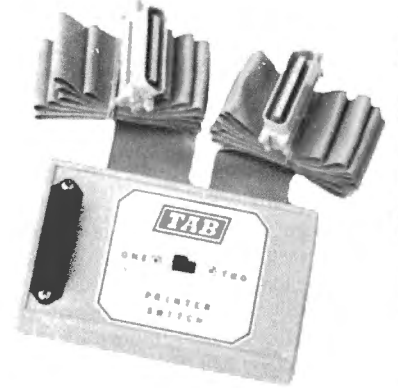

**ORDER TODAY  
Only \$69.95**

Other models available  
Dealer inquiries invited  
\$2.50 Shipping/Handling  
Florida residents add 5% sales tax

Cables built-in  
(optional lengths available)  
Nothing else to buy  
Fingertip control  
Just flick your switch

See your dealer 

or  
Call 1-800-874-1551 

**TAB SALES CO.—704 W. Michigan Ave.  
Pensacola, FL 32505**

P.O. Box 8098

Ph: 904-438-6507

# PIK'EM 85



**A Complete Pro Football  
Prediction Program For The  
1985 NFL SEASON**

**63% +** Accurate vs 'Spread' Since 1981  
More Features — More Information In 1985 To .....

## BEAT THE SPREAD

★ ★ FEATURES ★ ★

- Predicted Scores Each Week
- Season Schedule By Week/Team
- Records & Results:  
Scores By Week  
Scores By Team  
Division Standings  
Stats — Accumulated & Average  
1983-1984 Data Base
- Auto Opponent Input
- Auto Data Update
- Printed Copy All Screens
- Easy Update—Playoffs/1986
- Dealer Inquiries Invited

**49<sup>95</sup>** INCLUDES DISC DOCUMENTATION

- Apple II — IIe — III
- Commodore 64
- IBM PC
- TRS-80, MIII/IV
- Tandy 1000/1200/2000

STATS NEEDED TO RUN PROGRAM  
AVAILABLE IN LOCAL NEWSPAPERS

OR  
WE WILL FURNISH STATS BY MAIL & MODEM  
ALL 20 WEEKS — SEASON PRICE . . . 40<sup>00</sup>

PROGRAM COMES UPDATED THRU CURRENT  
WEEK OF SEASON . . . NO EXTRA CHARGE



Orders Call Collect  
24 Hrs.  
C.O.D.



**MARATHON SOFTWARE DEPT. M**  
P. O. BOX 1349  
JACKSONVILLE, TEXAS 75766  
(214) 586-8212

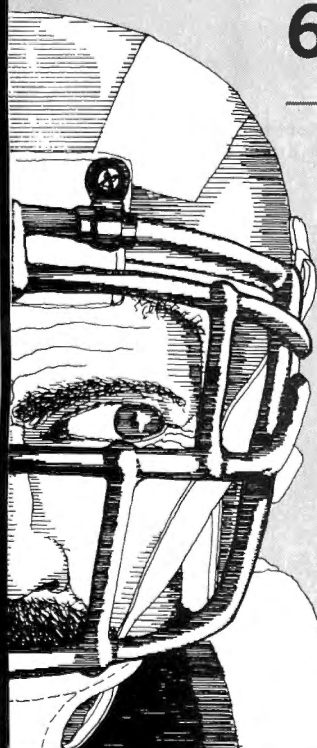



# Good Form: A Close Look At Basic Program Structure

**L**ike a story, a game of chess, or life itself, a Basic program has a beginning, middle, and an end. As you evolve as a programmer, your efforts become more intellectually complex, and you start to recognize the events and rhythms that mark these stages in a program.

For the sake of nonargument, suppose that Basic programs have only four fundamental forms, with these names:

**Arrow**—Linear in form, this Basic program shoots straight through its lines once and ends.

**Skipper**—This one jumps back and forth among line numbers.

**Crucible**—It returns again and again to one or more central testing areas whose products are sliced, diced, molded, and folded into results.

**Choice**—This type features a menu format in which you decide what part of the program to use. Choices lead to and from modular units, which you can think of as small crucibles within the main program.

I've listed these four program forms in the order in which most of us learn to use them. All require a start, middle, and end. Figure 1 shows a template that lumps subevents of these stages. I've keyed brief explanations to the line numbers in the template. The beginning of the program is its foundation.

•100—A remark line or lines. Traditional uses: Giving the program name, computer system, and memory requirements; author's name and address; copyright statement; and restrictions on use. You can run the program without this line.

•110—Data line. You don't need this line if you're not giving variable arrays values. It can go anywhere in the program but it traditionally comes first.

•120—CLS to clear the screen. Not necessary, but it's neat programming practice to start with a clean slate.

•130—A simple Clear statement sets nu-

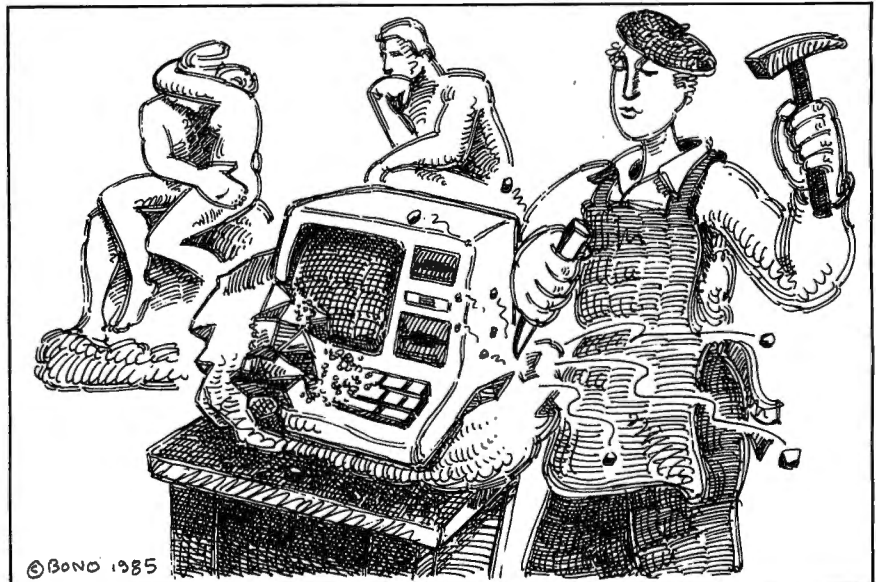

Program Listing 1. Job Aptitude Test.

```

100 REM * Job Aptitude Test * Model 4/4P
110 CLS
120 CLEAR
130 DIM B(2)
140 PRINT "Answer preference as 1 or 2, press enter."
150 INPUT "1-Shoveling 2-Typing";Z
160 IF Z<>1 AND Z<>2 THEN CLS: GOTO 150
170 B(Z)=B(Z)+1
180 CLS
190 INPUT "1-Flower 2-Wrench";Z
200 IF Z<>1 AND Z<>2 THEN CLS: GOTO 190
210 B(Z)=B(Z)+1
220 CLS
230 IF B(1)>B(2) THEN PRINT "Gardening or forestry await you."
240 IF B(2)>B(1) THEN PRINT "Try auto parts inventory."
250 IF B(1)=B(2) THEN PRINT "Write poetry."
260 END

```

End

Program Listing 2. Gumball Route.

```

100 REM * Gumball Route * Model 4/4P
110 DATA A,B,C,D,E,F
120 CLS
130 CLEAR
140 DEFSTR A-D
150 DIM A(6)
160 FOR X=1 TO 6
170 READ A(X)
180 NEXT X
190 RANDOM
200 MIL=500
210 D="A"
300 REM A -----
310 IF LEN(D)>5 THEN 1000
320 R=RND(2)
330 IF R=1 THEN T=T+10: D=D+"B": GOTO 400
340 T=T+12: D=D+"F": GOTO 800
400 REM B -----

```

Listing 2 continued

## System Requirements

Models III, 4, and 1000  
Basic



# MEGABYTES FOR MINI-BUCKS

## Model 1, 3, 4 Hard Drives

|               | Primary | Secondary |
|---------------|---------|-----------|
| 5 Megabyte —  | \$ 795. | \$ 595.   |
| 10 Megabyte — | \$1095. | \$ 895.   |
| 15 Megabyte — | \$1295. | \$1095.   |
| 30 Megabyte — | \$1895. | \$1695.   |

(Model 1 add \$50.)

### TRS-80 Hard Disk Subsystem Features\*

- \* All sizes rated after formatting
- \* TRS-80 Models 1,3,4, and 4P supported
- \* Your choice of DOSPLUS, LDOS, or TRSDOS 6.x Software Drivers included.
- \* Newdos 80/Version 2.5 Systems available.
- \* Up to two secondary drives may be added.
- \* Error checking and correcting controller.
- \* Buffered seek drives for improved access time.
- \* Built in power up diagnostics.
- \* Drives use plated media for long disk life.
- \* Heavy duty power supply.
- \* Fan cooled.
- \* Gold connectors used throughout for high reliability.
- \* 1 year warranty



Shop and compare. Hard Drive Specialist has been building hard drive systems for years and have sold thousands of subsystems to satisfied TRS-80 customers. We fully support TRS-80 Models 1,3,4, and 4P computers on available hard drive operating systems. We use the latest state-of-the-art drives and controllers. Our drives all use buffered seek logic and plated media to result in almost one-fourth the average access times found on our competitors drives. Plated media results in longer platter life and high resistance to head crashers not found on coated media drives. We utilize high construction throughout including heavy duty power supply, cooling fan and gold edge card connectors. We back our drives with a one year parts and labor warranty and we're so sure that you'll like our drive that we offer a thirty day money back guarantee. So when it comes time to buy, look beyond the price and choose the best drive. After all, we are the Hard Drive Specialist!

## HDS Multiplexer

**\$1295.**

The HDS Multiplexer allows the useage of up to 4 Model III or IV systems using Dosplus 3.5, LDOS, TRSDOS 6.x, and DOSPLUS IV on a HDS Hard Drive. The standard package includes the Master Control Unit, Host Adapters for 2 Computers and 40' of cable. Each additional Host adapter add \$150. Each additional foot of cable add \$1. up to 100 feet per computer.

### Model 3/4 Boot Rom \$39.95

Allows you to boot directly from a HDS Hard Drive using DOSPLUS. Versions available for useage with and without Multiplexer.

AS SEEN AT THE RADIO SHACK  
COMPUTER SHOWCASES

## Tandy 1000 Hardware

### Tandy 1000 TanPak

The first and only board that your Tandy 1000 may ever need. Your 1000 is very versatile, new applications and functions are being developed for it every day. And now with the HDS TanPak you can keep your options open for tomorrows technology. As you know the Tandy 1000 only has 3 expansion slots, and those are not quite PC compatible. The TanPak does the job using one expansion slot that normally would require four using Tandy boards. The TanPak includes a Serial Port, a Clock, and sockets for up to 512K of Memory Expansion. And the best part of all, it will save you some big bucks over the Tandy boards.

**TanPak 128K ..... \$399.**

Radio Shack and Tandy are trademarks of Tandy Corporation. TanPak, and TanTel are trademarks of Compukit Corporation.

## Hard Drive Kit

Put a 10 Megabyte Hard Drive inside your Tandy 1000. This Hard drive subsystem includes an interface card and a Half-Height Hard Drive that directly replaces a floppy disk drive in both size and power consumption drive.

- 10 Megabyte Internal Drive System ..... \$895.**
  - 10 Megabyte External Drive System ..... \$1095.**
  - 15 Megabyte External Drive System ..... \$1395.**
  - 30 Megabyte External Drive System ..... \$1895.**
- ### Disk Drives

Fast stepping add on or replacement disk drives for half the Radio Shack price ..... **\$149.**

## HARD DRIVE SPECIALIST

### Ordering Information

Use our Watts line to place your order Via Visa, MasterCard, or Wire Transfer. Or Mail you payment directly to us. Any non-certified funds will be held until proper clearance is made. COD orders are accepted as well as purchase orders from government agencies. Most items are shipped off the shelf with the exception of hard drive products that are custom built. UPS ground is our standard means of shipping unless otherwise specified. Shipping costs are available upon request.

**1-713-480-6000**

**Order Line 1-800-231-6671**

16208 Hickory Knoll,  
Houston, Texas 77059



Listing 2 continued

```

410 R=RND(4)
420 IF R=1 THEN T=T+10: D=D+"A": GOTO 300
430 IF R=2 THEN T=T+3: D=D+"F": GOTO 800
440 IF R=3 THEN T=T+2: D=D+"E": GOTO 700
450 T=T+8: D=D+"C": GOTO 500
500 REM C -----
510 R=RND(3)
520 IF R=1 THEN T=T+8: D=D+"B": GOTO 400
530 IF R=2 THEN T=T+7: D=D+"D": GOTO 600
540 T=T+5: D=D+"E": GOTO 700
600 REM D -----
610 R=RND(3)
620 IF R=1 THEN T=T+7: D=D+"C": GOTO 500
630 IF R=2 THEN T=T+8: D=D+"E": GOTO 700
640 T=T+6: D=D+"F": GOTO 800
700 REM E -----
710 R=RND(4)
720 IF R=1 THEN T=T+5: D=D+"C": GOTO 500
730 IF R=2 THEN T=T+2: D=D+"B": GOTO 400
740 IF R=3 THEN T=T+1: D=D+"F": GOTO 800
750 T=T+8: D=D+"D": GOTO 600
800 REM F -----
810 R=RND(4)
820 IF R=1 THEN T=T+6: D=D+"D": GOTO 600
830 IF R=2 THEN T=T+1: D=D+"E": GOTO 700
840 IF R=3 THEN T=T+3: D=D+"B": GOTO 400
850 T=T+12: D=D+"A": GOTO 300
1000 FOR X=1 TO 6
1010 IF INSTR(D,A(X))=0 THEN 320
1020 NEXT X
1030 IF T<MIL THEN MIL=T: PRINT T;D
1040 D="A"
1050 T=0
1060 GOTO 300
1070 END

```

End

### Program Listing 3. Interest.

```

100 REM * Interest * Model 4/4P
110 CLS
120 CLEAR
130 PRINT "INTEREST"
140 PRINT "This program figures interest on an investment
 compounded daily"
150 PRINT "and prints total at end of every 30 days."
160 PRINT
170 INPUT "Type amount invested and press enter";A
180 INPUT "Type annual interest (10 for 10 percent, for
 example) and press enter";I
190 INPUT "Number of days until withdrawal planned";M
200 I=I/100/365
210 FOR X=1 TO M
220 A=A+A*I
230 IF X/30=INT(X/30) THEN PRINT "Month"X/30;"-"A
240 NEXT X
250 PRINT
260 PRINT "Total at end of"M"days:"A
270 END

```

End

### Program Listing 4. Menu.

```

100 REM * Menu * TRS-80 Model 4/4P
110 DATA Appetizer,Soup,Salad,Entree,Beverage,Dessert
120 CLS
130 PRINT @ 670,"Menu Selection"
140 CLEAR
150 DEFSTR A,B
160 DIM A(6)
170 FOR X=1 TO 6
180 READ A(X)
190 NEXT
200 PRINT @ 990,"Tap a key to continue."
210 Q$=INKEY$
220 IF Q$="" THEN 200
230 CLS
240 PRINT "Categories:"
250 PRINT "-----"
260 FOR X=1 TO 6
270 PRINT X;"- "A(X);TAB(20);B(X)
280 NEXT X
290 PRINT STRING$(40,"-")

```

Listing 4 continued

meric variables to zero and string variables to nulls. The Clear statement offers options I won't go into because you don't need them at this stage.

- 140—Define statements restrict variables to certain uses. Two examples are DEFSTR, as in DEFSTR A, which defines a letter as a string without that pesky dollar sign (e.g., A = "clown"), and DEFINT, as in DEFINT B, which thereafter makes a variable's value an integer of any fractional result.

- 150—You can dimension arrays after you define them; for example, DIM A(20).

- 160—Your program should read in array values at this point; for example, FOR X = 1 TO 20:READ Z\$(X):NEXT X.

- 170—This is a good place to set all beginning values of variables; for example, M = 20.20:L\$ = "line".

- 180 and 190—The title and instructions are up to you, but they are well placed as the final events in program start-up. Your first program was probably of the arrow form, which generally runs straight through its lines and waits like a smug puppy to perform again:

```

100 REM *My First Program
110 PRINT "Look, Ma, I'm dancing!"
120 END

```

That same form can have its pragmatic uses, if it yields some result. See Program Listing 1, Job Aptitude Test. It's a tongue-in-cheek test, but it does illustrate the form: a series of questions whose answers the program keeps track of and acts on. You might use this format to give a test with multiple-choice answers, and to gather information for forms, such as employee files, inventory records, insurance claims, and the like.

#### **Start: Initialization**

- 100 Data line.
- 120 Clear screen.
- 130 Clear statement.
- 140 Define statement(s).
- 150 Dimension arrays.
- 160 Read in array values.
- 170 Set variable values.
- 180 Title screen.
- 190 Instructions.

#### **Middle: Actuation**

- 200 The program works on data supplied by the user and/or itself.

#### **End: Realization**

- 210 The result of work done in the middle phase is given and the program ends.
- 220 Subroutines.

*Figure 1. Program template.*



# BASIC TAKES

Listing 4 continued

```

300 PRINT
310 PRINT "Tap a number to make selection."
320 Q$=INKEY$
330 IF Q$="" OR INSTR("123456",Q$)=0 THEN 320
340 PRINT
350 C=VAL(Q$)
360 ON C GOSUB 380,400,420,440,460,480
370 GOTO 230
380 PRINT "Type choice for APPETIZER and press enter."
390 INPUT B(C): RETURN
400 PRINT "Type SOUP choice and enter."
410 INPUT B(C): RETURN
420 PRINT "Select SALAD and enter."
430 INPUT B(C): RETURN
440 PRINT "ENTREE selection (and enter)"
450 INPUT B(C): RETURN
460 PRINT "Enter a BEVERAGE."
470 INPUT B(C): RETURN
480 PRINT "DESSERT selection."
490 INPUT B(C): RETURN
500 END

```

End

Menu (Program Listing 4) is about food, but remember that the menu of Basic pertains to listing user choices, not culinary decisions. This menu about food illustrates how you can, in this case, plan a meal by adding and replacing elements. Lines 260-280 contain a loop that prints menu choices. Line 320 invites a choice from 1 to 6, and the INSTR test in line 330 prevents any answer except 1 through 6. Line 360 sends the program to the appropriate area for action. This line is a good Basic command to learn, for it shortens otherwise messy decisions.

In a more complex menu program, you might have choices to load material to and from disk, to sort, add, delete, line print items meeting tests set within the program, and more. There's always more.

I'm not claiming that these four forms encompass all of Basic programming. However, when you study program format, I think you'll find many examples that neatly fit these ideas. The four examples should give you a clue to your Basic progress. If you are just arriving at the arrow stage, take heart. The journey ahead grows more interesting. ■

Contact Richard Ramella at 1493 Mountain View Ave., Chico, CA 95926.

Circle 355 on Reader Service card.

## LARGE CAPACITY ACCOUNTING PROGRAMS

FOR TRS-80 1, 3, 4 & 4P, LNW, LOBO

★ NEED JUST 2 DRIVES FOR CAPACITY BELOW ★

### ACCTS RECEIVABLE \$150.00

5000+ ACCOUNTS 15000+TRANSACTIONS  
BALANCE FORWARD 99 TRANSACT CODES  
30 - 60 - 90 - 120 AGED STATEMENTS SHOW  
DATE / INV # / DESCRIPT / AMT / & AGEING  
SELECTIVE FINANCE CHARGES & RATES.  
FAST ENTRY POSTING W / AUDIT REPORT.  
SUB - ACCTS. % CREDIT LIMIT DATE OF  
LAST PAYMENT, LABELS  
ADD \$50.00 FOR INVOICING MODULE  
OTHER OPTIONS AVAILABLE - CALL

### ACCTS PAYABLE \$50.00

DERIVED FROM OUR A/R - WRITES CHECKS

### GENERAL LEDGER \$150.00

400+ACCTS 5000+TRANSACTIONS/MONTH  
- BEST LOOKING FINANCIAL STATEMENTS  
- DEPARTMENTAL P & L (UP TO 9)  
- STATEMENT OF CHANGES  
- SUB-TOTALS WHERE YOU WANT  
- FAST FLEXIBLE POSTING INPUT  
- PERCENTAGE P & L

DEMO AVAILABLE \$20.00 EACH  
APPLIES TOWARDS PURCHASE

### COMBINATION SPECIALS

# 1 A/R & G/L FOR ..... \$200.00  
# 2 A/R, A/P & G/L FOR ..... \$225.00  
HARD DISK VERSION SLIGHTLY MORE

VISA

H.D.P.

MC

2366 Lincoln, Oroville, CA 95965

916-533-5992

MON-FRI 8AM TO 2PM

ADD 3.00 S & H

ADD 3.00 COD

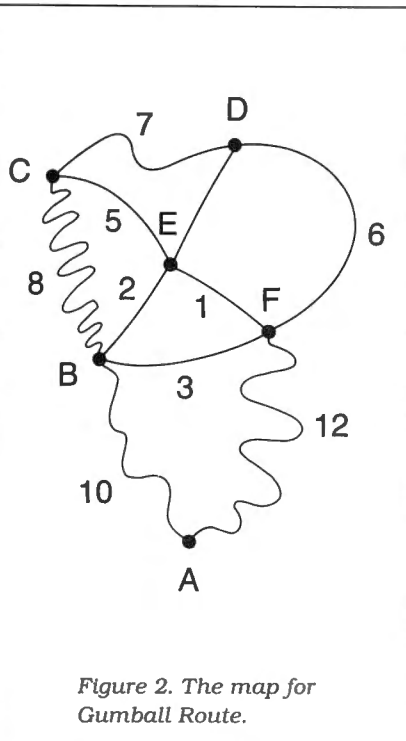

Figure 2. The map for Gumball Route.

The arrow is a simple and useful form on which a beginner can build.

The next beginner's discovery is the skipper, and programming life temporarily becomes a merry series of GOTOs. The skipper can create problems because it's tough to keep control of all the action. It demands precision and attention. Making a skipper work can be disheartening.

The example I've used, Gumball Route (Program Listing 2), is a computer solution to the problem in Fig. 2. That figure shows the mileage among six towns: A, B, C, D, E, and F. The gumball route driver's goal is to start at A, visit each site, and return to A in the shortest possible route. Traditionally, this is called the Traveling Salesman Problem.

It's really critical path scheduling.

The program I've written finds the best possible answer it can by bumbling along the route. Watch the program run. Read the listing's events. I think you'll see what happens. The program will continue to search for a shorter route until you break into it to stop it. I should warn you that even mildly complex critical path simulations might take longer to produce good results than you have time to wait.

So, the arrow form of programming is simplistic and of limited effectiveness. The skipper has its charm but it's difficult to form. We come to my favorite, the crucible. It's the quintessential Basic program format. You might use hundreds of lines to set up the situation, and the crucible focuses on one small area, bringing all force to bear on one or more crucial program events.

Now that I've made it sound mystical, let me deflate myself by offering a lowly example. It's Interest (Program Listing 3). Look at lines 210-240. They contain a For. . . Next loop that prints the building result of an investment. It could loop a million times if asked. It is the crucible of the program, and it is also the result.

In studying programs written by others, look for that crucible to get a quick understanding of what happens and why. Problems with the crucible? Some programs include so many GOSUBs. If. . . Then tests, changing values, and actions that they slow run time measurably. A program performing 50 tests within a crucial area can turn a run into an ice jam.

Now for the choice. It's also called a menu program. It gives you a screen menu from which the program goes on command to a subevent—and returns to the menu. GOSUB and GOTO trigger these forays. A menu program can be speedy because it avoids program areas not needed at the moment.



# Wide Open: Windows for Your Model 4

**W**ith this month's program, I'll complete my Model 4 windowing system. The Program Listing is the system's user interface; it lets you redefine a window or invoke any TRSDOS library command at any time without destroying the screen contents.

Assemble this month's program as WU/FLT. Then, provided you named the first program WD/CMD (see the June Next Step, p. 102) and last month's program WS/CMD (see p. 100), you can install the entire windowing system from the TRSDOS Ready prompt with these commands:

```
WD
WS
SET *WU WU
FILTER *KI *WU
```

The first line puts the window driver in place, the second adds the windowing supervisory call (SVC), and the last two lines link this month's user routine to the keyboard driver. As each module loads, it prints an appropriate message on the screen.

When you have all three programs up and running, you can press control-W at any time and a block of information will appear at the top of the screen telling you the row and column parameters of the present window as well as how many windows sit in an alternate memory bank.

The program gives you the option of opening a new window, closing a window and returning to the one below it, calling a DOS command, or returning to the present window and the program running there. Programs that display text with the @DSPLY and @DSP SVCs will stay within whatever windows you set. Those that transfer blocks of data directly to the screen or move the cursor to specific locations may not.



Program Listing. The windowing system's user interface.

```
00002 ;*****
00003 ;
00004 ; Windowing system -- User interface
00005 ;
00006 ; Installation instructions:
00007 ; SET *dv WINDOW/FLT
00008 ; FILTER *KI *dv
00009 ;
00010 ;*****
00011 ;
00012 ;SVCs used:
00013 @CHNIC EQU 20
00014 @CKBRKC EQU 106
00015 @CLS EQU 105
00016 @CMNDR EQU 25
00017 @DCEHEX EQU 96
00018 @DSPLY EQU 10
00019 @EXIT EQU 22
00020 @FLAGS EQU 101
00021 @GTMOD EQU 83
00022 @HIGH$ EQU 100
00023 @KEY EQU 1
00024 @KEYIN EQU 9
00025 @WINDOW EQU 127
00026 ;-----
00027 ; Other equates:
00028 CR EQU 0DH ;Carriage return character
00029 LF EQU 0AH ;Line feed
00030 ETX EQU 03H
00031 ;
00032 ;-----
00033 ;
00034 ; If you use EDAS or PRO-CREATE, add the following Macro definition:
00035 ;
00036 ;SVC MACRO #NUM
00037 ; LD A,#NUM
00038 ; RST 28H
00039 ; ENDM
00040 ;
00041 ; Also change all uses of '.SHL.' to '<'
00042 ; for example, LD BC,1.SHL.8+191
00043 ; should become LD BC,1<8+191
00044 ;
00045 ;*****
00046 ;
00047 PSECT 3000H ;With EDAS use ORG 3000H
00048 BEGIN JR START ;Set up standard header
```

Listing continued



## System Requirements

Models 4 and 4P  
128K RAM  
TRSDOS 6.2  
Assembly language  
Editor/assembler



# H & E COMPUTRONICS INC.

•• EVERYTHING FOR YOUR TRS-80™ • ATARI™ • APPLE™ • PET™ • CP/M™ • XEROX™ • IBM™ • OSBORNE™ ••

\* TRS-80 is a trademark of the Radio Shack Division of Tandy Corp. - \* ATARI is a trademark of Atari Inc. - \* APPLE is a trademark of Apple Corp. - \* PET is a trademark of Commodore  
\* CP/M is a trademark of Digital Research - \* XEROX is a trademark of Xerox Corp. - \* IBM is a trademark of IBM Corp. - \* OSBORNE is a trademark of Osborne Corp.



## BUSINESS PAC 100 100 Ready-To-Run Business Programs

★ All orders processed within 24-Hours  
★ 30-Day money back guarantee

(ON CASSETTE OR DISKETTE).....Includes 128 Page Users Manual.....  
Inventory Control.....Payroll.....Bookkeeping System.....Stock Calculations.....  
Checkbook Maintenance.....Accounts Receivable.....Accounts Payable.....

### BUSINESS 100 PROGRAM LIST

| NAME          | DESCRIPTION                                            |
|---------------|--------------------------------------------------------|
| 1 RULE78      | Interest Apportionment by Rule of the 78's             |
| 2 ANNU1       | Annuity computation program                            |
| 3 DATE        | Time between dates                                     |
| 4 DAYYEAR     | Day of year a particular date falls on                 |
| 5 LEASEINT    | Interest rate on lease                                 |
| 6 BREAKEVN    | Breakeven analysis                                     |
| 7 DEPRSL      | Straightline depreciation                              |
| 8 DEPRSY      | Sum of the digits depreciation                         |
| 9 DEPRDB      | Declining balance depreciation                         |
| 10 DEPRDDB    | Double declining balance depreciation                  |
| 11 TAXDEP     | Cash flow vs. depreciation tables                      |
| 12 CHECK2     | Prints NEBS checks along with daily register           |
| 13 CHECKBK1   | Checkbook maintenance program                          |
| 14 MORTGAGE/A | Mortgage amortization table                            |
| 15 MULTMON    | Computes time needed for money to double, triple, etc. |
| 16 SALVAGE    | Determines salvage value of an investment              |
| 17 RRVARIN    | Rate of return on investment with variable inflows     |
| 18 RRCONST    | Rate of return on investment with constant inflows     |
| 19 EFFECT     | Effective interest rate of a loan                      |
| 20 FVAL       | Future value of an investment (compound interest)      |
| 21 PVAL       | Present value of a future amount                       |
| 22 LOANPAY    | Amount of payment on a loan                            |
| 23 REGWTH     | Equal withdrawals from investment to leave 0 over      |
| 24 SIMPDISK   | Simple discount analysis                               |
| 25 DATEVAL    | Equivalent & nonequivalent dated values for oblig.     |
| 26 ANNUDEF    | Present value of deferred annuities                    |
| 27 MARKUP     | % Markup analysis for items                            |
| 28 SINKFUND   | Sinking fund amortization program                      |
| 29 BONDDVAL   | Value of a bond                                        |
| 30 DEplete    | Depletion analysis                                     |
| 31 BLACKSH    | Black Scholes options analysis                         |
| 32 STOCVAL1   | Expected return on stock via discounts dividends       |
| 33 WARVAL     | Value of a warrant                                     |
| 34 BONDDVAL2  | Value of a bond                                        |
| 35 EPSEST     | Estimate of future earnings per share for company      |
| 36 BETAALPH   | Computes alpha and beta variables for stock            |
| 37 SHARPE1    | Portfolio selection model-i.e. what stocks to hold     |
| 38 OPTWRITE   | Option writing computations                            |
| 39 RTVAL      | Value of a right                                       |
| 40 EXPVAL     | Expected value analysis                                |
| 41 BAYES      | Bayesian decisions                                     |
| 42 VALPRINF   | Value of perfect information                           |
| 43 VALADINF   | Value of additional information                        |
| 44 UTILITY    | Derives utility function                               |
| 45 SIMPLEX    | Linear programming solution by simplex method          |
| 46 TRANS      | Transportation method for linear programming           |
| 47 EOQ        | Economic order quantity inventory model                |
| 48 QUEUE1     | Single server queueing (waiting line) model            |
| 49 CVP        | Cost-volume-profit analysis                            |
| 50 CONDPFR    | Conditional profit tables                              |
| 51 OPTLOSS    | Opportunity loss tables                                |
| 52 FQOJQ      | Fixed quantity economic order quantity model           |
| 53 FQEOVSH    | As above but with shortages permitted                  |
| 54 FQEOQPB    | As above but with quantity price breaks                |
| 55 QUEUECB    | Cost-benefit waiting line analysis                     |
| 56 NCFANAL    | Net cash-flow analysis for simple investment           |
| 57 PROFIND    | Profitability index of a project                       |
| 58 CAPI       | Cap. Asset Pr. Model analysis of project               |

|              |                                                     |
|--------------|-----------------------------------------------------|
| 59 WACC      | Weighted average cost of capital                    |
| 60 COMBAL    | True rate on loan with compensating bal. required   |
| 61 DISCBAL   | True rate on discounted loan                        |
| 62 MERGANAL  | Merger analysis computations                        |
| 63 FINRAT    | Financial ratios for a firm                         |
| 64 NPV       | Net present value of project                        |
| 65 PRINDLAS  | Laspeyres price index                               |
| 66 PRINDPA   | Paasche price index                                 |
| 67 SEASIND   | Constructs seasonal quantity indices for company    |
| 68 TIMETR    | Time series analysis linear trend                   |
| 69 TIMEOV    | Time series analysis moving average trend           |
| 70 FUPRINF   | Future price estimation with inflation              |
| 71 MAILPAC   | Mailing list system                                 |
| 72 LETWRT    | Letter writing system-links with MAILPAC            |
| 73 SORT3     | Sorts list of names                                 |
| 74 LABEL1    | Shipping label maker                                |
| 75 LABEL2    | Name label maker                                    |
| 76 BUSKID    | HOME business bookkeeping system                    |
| 77 TIMECLK   | Computes weeks total hours from timeclock info.     |
| 78 ACCTPAY   | In memory accounts payable system-storage permitted |
| 79 INVOICE   | Generate invoice on screen and print on printer     |
| 80 INVENT2   | In memory inventory control system                  |
| 81 TELDIR    | Computerized telephone directory                    |
| 82 TIMJAN    | Time use analysis                                   |
| 83 ASSIGN    | Use of assignment algorithm for optimal job assign. |
| 84 ACCTREC   | In memory accounts receivable system-storage ok     |
| 85 TERMSPAY  | Compares 3 methods of repayment of loans            |
| 86 PAYNET    | Computes gross pay required for given net           |
| 87 SELLPR    | Computes selling price for given after tax amount   |
| 88 ARBCOMP   | Arbitrage computations                              |
| 89 DEPRSF    | Sinking fund depreciation                           |
| 90 UPSZONE   | Finds UPS zones from zip code                       |
| 91 ENVELOPE  | Types envelope including return address             |
| 92 AUTOEXP   | Automobile expense analysis                         |
| 93 INSFILE   | Insurance policy file                               |
| 94 PAYROLL2  | In memory payroll system                            |
| 95 DILANAL   | Dilution analysis                                   |
| 96 LOANAFFD  | Loan amount a borrower can afford                   |
| 97 RENTPRCH  | Purchase price for rental property                  |
| 98 SALELEAS  | Sale-leaseback analysis                             |
| 99 RRCONVBD  | Investor's rate of return on convertible bond       |
| 100 PORTVAL9 | Stock market portfolio storage-valuation program    |

- TRS-80 Cassette Version \$99.95
- TRS-80 (Mod-I or III), Pet, Apple or Atari Versions \$99.95
- TRS-80 Mod-II, IBM, Osborne and CP/M Versions \$149.95

ADD \$3.00 FOR SHIPPING IN UPS AREAS  
ADD \$4.00 FOR C.O.D. OR NON-UPS AREAS  
ADD \$5.00 TO CANADA AND MEXICO  
ADD PROPER POSTAGE OUTSIDE OF U.S., CANADA AND MEXICO

**COMPUTRONICS**  
MATHEMATICAL APPLICATIONS SERVICE

50 N. PASCACK ROAD  
SPRING VALLEY, NEW YORK 10977

ASK FOR OUR 64-PAGE CATALOG  
DEALER INQUIRIES INVITED

NEW TOLL-FREE  
ORDER LINE  
(OUTSIDE OF N.Y. STATE)  
(800) 431-2818



24 HOUR  
ORDER  
LINE



(914) 425-1535



ALL PRICES & SPECIFICATIONS SUBJECT TO CHANGE  
DELIVERY SUBJECT TO AVAILABILITY



## THE NEXT STEP

Listing continued

```

00049 OLDHI DW 0 ;Save old HIGH$
00050 DB 2 ;Name length
00051 DEFM 'WU' ;Module name
00052 MODDCB DW 0 ;Storage space
00053 DW 0 ;Reserved for system
00054 NOW_ON DB 0 ;Flag for current status
00055 OPREG DB 0 ;Storage for OPREG$ image
00056 CFLAG DB 0 ;Storage for CFLAG$ image
00057 NUM_W DB 0 ;Storage for current # of windows
00058 OVRLY DB 0 ;Storage for overlay number
00059 ;
00060 ;-----
00061 ;
00062 START JR C,FILTER ;Go if @GET request
00063 ;
00064 ; Here if @CTL
00065 ;
00066 CHAIN LD IX,(MODDCB) ;Get DCB pointer from header
00067 RL01 EQU $-2
00068 SVC @CHNIO ;Pass down the chain
00069 RET
00070 ;
00071 ; Here if @GET
00072 ;
00073 FILTER CALL CHAIN ;Get keystroke
00074 RL02 EQU $-2
00075 RET NZ ;If no character or error
00076 ;
00077 ; Character was received from I/O chain
00078 ;
00079 CP 17H ;Ctrl-W ?
00080 JR Z,MAYBE ;Yes -- continue
00081 CP A ;Reset Z flag
00082 RET ;Back to caller
00083 ;
00084 ; Got a Ctrl-W. Now avoid recursion
00085 ;
00086 MAYBE LD A,(NOW_ON) ;P/u current flag
00087 RL03 EQU $-2
00088 OR A ;Check setting
00089 JR Z,OKAY ;Go if not on
00090 LEAVE OR 1 ;Set NZ flag
00091 LD A,0 ;No key
00092 RET ;And back to caller
00093 ;

```

Listing continued

If you plan to use a job control language (JCL) file to set up the window system, you should make a small change in the window driver program from June 1985. Near the end of the program, add a line just before the @EXIT SVC that returns control to TRSDOS. The new line should read LD HL,0. Without this line, the JCL thinks the program is reporting an error and aborts.

### The User Interface

This month's program is a keyboard filter, with a structure similar to the one I presented in November 1984 (p. 168). The computer calls the filter every time a program asks TRSDOS for keyboard input. If you press control-W, this filter springs into action; otherwise, it passes whatever key you pressed back to the calling program.

The beginning of the program first checks to verify that you've pressed a key, then tests to see if the key is a control-W, and finally checks to ensure that you don't already have the filter running. Without this final check, chaos could result; the filter could end up calling itself over and over, unable to get back to the program that originally called it.

Circle 71 on Reader Service card.

# T80-FS1 Flight Simulator

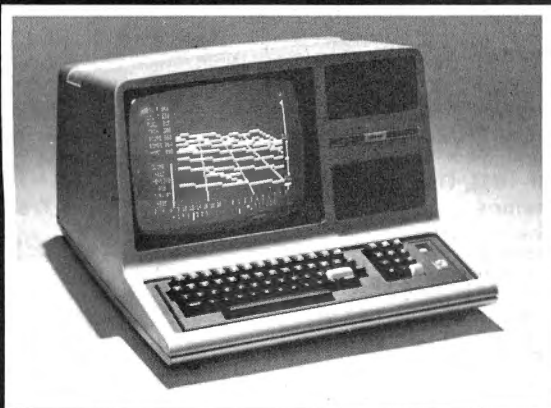

**See your dealer!**

Available for Model I or Model III. \$25.00 on cassette or \$33.50 on disk (with enhancements) All versions require 16K.

If you order direct, please specify whether you have Model I or Model III (the media are different) and whether you want disk or cassette. Include \$1.50 and indicate UPS or first class mail. Illinois residents add 5% sales tax. Visa and Mastercard accepted.

If you don't yet own a disk, don't fret. You can upgrade anytime. Cassette users may send back their cassette (but not the manual) along with \$10 (first class shipping included) and receive the disk version.

## subLOGIC

Communications Corp.  
713 Edgebrook Drive  
Champaign, IL 61820  
(217) 359-8482  
Telex: 206995



## THE NEXT STEP

Once it finishes the tests (line 96), the program sets a flag to show that it's operating. Then it saves the primary and index registers and, by using the window SVC, gets the parameters of the present window.

If the window storage area is full, control returns immediately to the calling program because you can't open any new windows. Otherwise, the program translates the present parameters into ASCII decimal and saves them in display strings. Next, the program sets up its own display window at the top of the screen, clears it, displays the command prompts, and waits for you to press one of four input keys (lines 148-159). It loops until you press a key, then jumps to the appropriate routine.

If you choose to return to the running program, the routine labeled Done (lines 161-177) closes the prompt window, restores the previous condition of the screen and the Z80's registers, then exits as it signals to the calling program that you haven't pressed a key.

The routine to close a window is also very simple. It closes the prompt window and jumps to Done to close the top user window before returning to the running program.

The other two routines are more complex. The DOS routine (lines 183-233) begins by closing the prompt window. Then it saves the current state of the C flag before setting it to allow only DOS library commands.

The DOS routine uses the @CMNDR SVC to send a command to the system for execution, but there is a fundamental problem with using that SVC from a filter. The System commands in TRSDOS use two overlay areas: SYS1-SYS5 and SYS10-SYS12 use the first, 1E00-22FF hexadecimal (hex). The library commands in SYS6 through SYS8 use the second overlay area, 2300-2FFF hex. TRSDOS stores a value at 0069 hex to keep track of the overlay currently in memory. Normally, you can use @CMNDR from a running program without problems. However, if you do so from an input/output filter, the system call might change the contents of the low overlay area. When the filter returns control to the normal input/output path, the routines it expects in the low memory will no longer be there. As a result, your system will crash, sometimes with strange sounds emanating from the internal speaker, sometimes with a frozen display, and sometimes with the disk drives running for no apparent reason.

Therefore, a filter that might cause the low overlay area to change must restore that section of memory before exiting back to the system. I'm sure there must be a way to use TRSDOS routines to per-

Listing continued

```

00094 ; Got here successfully with Ctrl-W
00095 ;
00096 OKAY CPL ;Show that we're here
00097 LD (NOW_ON),A ;And store
00098 RL04 EQU $-2
00099 PUSH BC ;Save everything
00100 PUSH DE
00101 PUSH HL
00102 PUSH IX
00103 PUSH IY
00104 LD B,2 ;Query present window
00105 SVC @WINDOW
00106 LD A,C ;Get current # of windows
00107 CP 15 ;Already full?
00108 JR NC,DONE2 ;Go if no room
00109 LD (NUM_W),A ;Else save count
00110 RL05 EQU $-2
00111 SVC @FLAGS ;IY ==> Flag registers
00112 LD A,(IY+'O'-'A') ;Get OPREG$
00113 LD (OPREG),A ;And save in data area
00114 RL06 EQU $-2
00115 ;
00116 ; Save present parameters in display string
00117 ;
00118 PUSH BC ;Save window count
00119 PUSH DE ;Save bottom paramters
00120 LD DE,TOPW ;DE ==> Display area
00121 RL07 EQU $-2
00122 CALL PARM_DEC ;Put in display string
00123 RL08 EQU $-2
00124 POP HL ;Get bottom parameters
00125 LD DE,BOTW ;DE ==> Display area
00126 RL09 EQU $-2
00127 CALL PARM_DEC ;Put in display string
00128 RL10 EQU $-2
00129 POP HL ;Get window count
00130 LD DE,OPNW ;DE ==> Display area
00131 RL11 EQU $-2
00132 CALL CONVL ;Display value in L
00133 RL12 EQU $-2
00134 ;
00135 ; Set up new window and display info
00136 ;
00137 OUR_W LD BC,1.SHL.8+191 ;Open & outline window
00138 LD HL,0 ;Top corner = 0,0

```

Listing continued

Circle 103 on Reader Service card.

# BRICKWARE

If you invest in brick and mortar, then you should invest in our brickware, Investor III™. Designed by real estate professionals to work on the IBM PC or TRS-80, Investor III™ is a comprehensive software package that aids in investment analysis of property, whether commercial or residential, small or large. It shows both the tax **and** cash aspects of an investment opportunity and is flexible enough to allow you to vary a number of key assumptions (such as cash flow, phased investments, multiple mortgages, and tax parameters) and see the results in an instant. So if you are serious about brick and mortar, look at our brickware. It will help you lay a solid foundation for your investment strategy. Contact your local dealer.

**GOOD**  
SOFTWARE CORP.

A Division of The Goodman Group, Inc.

12900 Preston Road  
Dallas, Texas 75230  
(214) 239-6085

Now available  
at Radio Shack  
stores through  
Express Order  
Software Program.

\$249.00 Suggested Retail  
**Making dollars and sense  
out of information.**

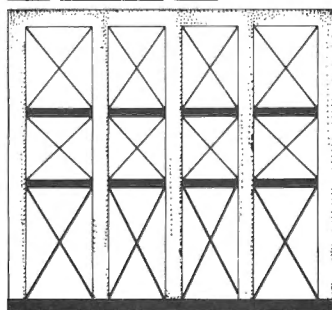



Listing continued

```

00139 LD DE,3.SHL.8+79 ;Bottom = 3,79
00140 SVC @WINDOW ;Set new window
00141 SHOW SVC @CLS ;Clear screen, set 80 char.
00142 LD HL,PROMPT1 ;HL==> Prompt message
00143 RL13 EQU $-2
00144 @DSPLY SVC ;Display it
00145 ;
00146 ; Wait for input and perform requested action
00147 ;
00148 INPUT1 SVC @KEY ;Get a key
00149 AND SFH ;Convert to upper case
00150 CP 'R' ;Return request?
00151 JR Z,DONE ;Yes -- go
00152 CP 'C' ;Close request?
00153 JR Z,CLOSE
00154 CP 'O' ;Open request?
00155 JP Z,OPEN
00156 RL14 EQU $-2
00157 CP 'D' ;Dos request?
00158 JR Z,DOS
00159 JR INPUT1 ;Loop for legal entry
00160 ;
00161 DONE LD B,0 ;Function: close window
00162 SVC @WINDOW
00163 DONE1 LD A,(OPREG) ;Get memory image
00164 RL15 EQU $-2
00165 OUT (84H),A ;Re-establish
00166 LD (IY+'O'-'A'),A ;And reset OPREG$
00167 DONE2 XOR A ;A = 0
00168 LD (NOW_ON),A ;Store ="not here"
00169 RL16 EQU $-2
00170 POP IY ;Recover all registers
00171 POP IX
00172 POP HL
00173 POP DE
00174 POP BC
00175 OR 1 ;Set NZ flag
00176 LD A,0 ;No character to return
00177 RET ;Back to caller
00178 ;
00179 CLOSE LD B,0 ;Function: close window
00180 SVC @WINDOW ;One window closed
00181 JR DONE ;And leave
00182 ;
00183 DOS LD B,0 ;Function: close window
00184 SVC @WINDOW ;Close our window
00185 LD A,(IY+'C'-'A') ;Get CFLAG$
00186 LD (CFLAG),A ;Save in data area
00187 RL17 EQU $-2
00188 SET 4,(IY+'C'-'A') ;Only allow library commands
00189 LD A,(0069H) ;Get current overlay number
00190 LD (OVRLY),A ;and save
00191 RL18 EQU $-2
00192 LD HL,1E00H ;Beginning of low overlay area
00193 LD DE,OVRBUF ;DE==> Temporary storage
00194 RL19 EQU $-2
00195 LD BC,500H ;Bytes to move
00196 LDIR ;Save low overlay area
00197 ;
00198 ; Open full-screen window
00199 ;
00200 LD HL,0 ;Top: 0,0
00201 LD DE,23.SHL.8+79 ;Bottom 23,79
00202 LD BC,1.SHL.8 ;Function: open window
00203 SVC @WINDOW ;Open full-screen window
00204 DOSCMD LD HL,DOSMSG ;HL==> Prompt
00205 RL20 EQU $-2
00206 @DSPLY SVC ;On screen
00207 LD HL,INBUF$;HL==> system input buffer
00208 RL21 EQU $-2
00209 LD BC,79.SHL.8
00210 SVC @KEYIN ;Get the command
00211 JR NZ,DOSEND ;Go if error
00212 JR C,DOSEND ; or if <break>
00213 SVC @CMNDR ;Process the request
00214 WAIT SVC @KEY ;Wait for key stroke
00215 JR NZ,WAIT ;Loop if error
00216 JR DOSCMD ;Loop for another command
00217 DOSEND SVC @FLAGS ;IY==> flag table
00218 LD A,(CFLAG) ;P/u old version
00219 RL22 EQU $-2
00220 LD (IY+'C'-'A'),A ;Replace old version
00221 LD HL,OVRBUF ;HL==Temp storage
00222 RL23 EQU $-2
00223 LD DE,1E00H ;Overlay area
00224 LD BC,500H ;Bytes to restore
00225 LDIR ;Restore low overlay area
00226 LD A,(OVRLY) ;Get old overlay number
00227 RL24 EQU $-2
00228 LD (0069H),A ;Put back in OVRLY$
00229 SVC @CKBRKC ;Clear <break> flag
00230 LD B,0 ;Function: close window
00231 SVC @WINDOW ;Return to original window
00232 JP OUR_W ;Back to our window
00233 RL25 EQU $-2
00234 ;
00235 OPEN LD A,(NUM_W) ;Get current window count
00236 RL26 EQU $-2
00237 CP 14 ;Storage full?
00238 JP NC,INPUT1 ;Yes -- get a new command
00239 RL27 EQU $-2
00240 SVC @CLS ;Else clear our screen
00241 LD HL,TOPMSG ;HL==> message
00242 RL28 EQU $-2
00243 SVC @DSPLY ;And display

```

Listing continued

form the restore, but I haven't found it yet. So, this program stores the entire low overlay area in a buffer, as well as the byte that indicates what overlay is in memory.

The remainder of the DOS routine is simple. It opens a full-screen window and prompts you for a DOS command. The routine passes that command to the system, and a loop returns for another command until you stop it by pressing the break key. Then the program restores everything in low memory to its previous state and loops back to the prompt window.

The final routine opens a new display window (lines 235-283). It clears the prompt area and asks you for the new window parameters.

The only difficult part of this section is accepting the ASCII decimal values you type in and changing them to the binary format the computer requires. The GET RC routine (lines 285-298) does most of the difficult part.

If you enter illegal values or press the break key while entering the parameters, the program returns to the prompt window for further instructions. Otherwise, it opens the new window and exits to it.

The installation section of the program (lines 360-467) does nothing tricky. This program relies on last month's windowing SVC, so it first checks to be sure you've installed that SVC. Since the user interface is a filter, it must also test to see that you used the Set command to load it.

If everything has gone well, the computer moves the main program to high memory and protects it; then the program sets its device control block to show that the filter is capable of handling @GET and @CTL commands. Finally, the initialization section reports a successful installation and returns control to TRSDOS.

### Final Comments

The windowing system is the most extensive set of programs I have presented in The Next Step. Depending on your programming needs, you may want to use just the driver, the driver and windowing SVC, or all three for particular projects.

The windows work well with some programs, poorly with others. You'll have to experiment to see how they work with your Model 4 programs. If you wish, you could use the first two programs to create a system of pull-down menus. Also, with a few changes, you could use the second program to create two active windows on the screen at once.

If you develop any interesting applications with the window system, I'd enjoy seeing them on a disk, along with your source code if possible. Please re-



## THE NEXT STEP

member that *80 Micro* owns the copyright to this windowing system; if you want to distribute any programs based on it, you'll have to take care of some legal formalities first.

A set of programs this complex probably has a bug or two in it. If you find one, write to me and describe in detail what I can do to demonstrate the bug. If you find any major bugs, I'll be sure to include patches in a future column. Please remember, however, that there's a lag time between when I write a column and when you see it. I finished this column during the first week of April. If I hear of a major bug in August, you might not read about it until early next year. ■

*You can contact Hardin Brothers through CompuServe. Go PCS-117 to the Writers' and Editors' SIG (WESIG) and leave your message addressed to him. Feel free to join in discussions started by others.*

*You can also write to Hardin at 280 N. Campus Ave., Upland, CA 91786. Enclose a stamped, self-addressed envelope if you want a reply.*

### Listing continued

```

00244 CALL GET_RC ;Get top row/column
00245 RL29 EQU $-2
00246 JP C,SHOW ;Back on <break>
00247 RL30 EQU $-2
00248 PUSH HL ;Save top row/col
00249 LD HL,BOTMSG ;HL==> bottom prompt
00250 RL31 EQU $-2
00251 SVC @DSPLY ;And display
00252 CALL GET_RC ;Get bottom row/col
00253 RL32 EQU $-2
00254 JR NC,OPEN2 ;Go if no <break>
00255 POP HL ;Else clear stack
00256 JP SHOW ;Back on <break>
00257 RL33 EQU $-2
00258 OPEN2 PUSH HL ;Save bottom row/col
00259 LD HL,FRMSG ;HL==> frame request
00260 RL34 EQU $-2
00261 SVC @DSPLY ;Display it
00262 LD HL,INBUF$;HL==> DOS input buffer
00263 RL35 EQU $-2
00264 LD BC,3.SHL.8 ;B = maximum characters
00265 SVC @KEYIN ;Get frame character
00266 JR NC,OPEN3 ;Go if no <break>
00267 POP HL ;Else clear the stack
00268 POP HL
00269 JP SHOW ;Back on <break>
00270 RL36 EQU $-2
00271 OPEN3 SVC @DECHX ;Convert frame value
00272 PUSH BC ;Save frame value for later
00273 LD B,0 ;Function: close window
00274 SVC @WINDOW
00275 POP BC ;Recover frame value in C
00276 POP DE ;P/u bottom row/col
00277 POP HL ;And top row/col
00278 LD B,1 ;Function: open window
00279 SVC @WINDOW
00280 JP NZ,OUR_W ;To our window if error
00281 RL37 EQU $-2
00282 JP DONE1 ;Back to running program
00283 RL38 EQU $-2
00284 ;
00285 GET_RC LD HL,INBUF$;HL==> DOS input buffer
00286 RL39 EQU $-2
00287 LD BC,6.SHL.8 ;B = maximum characters
00288 SVC @KEYIN ;Get top row/col
00289 RET C ;Back on <break>

```

*Listing continued*

Circle 496 on Reader Service card.

# Communications Gap? LET'S TALK™!

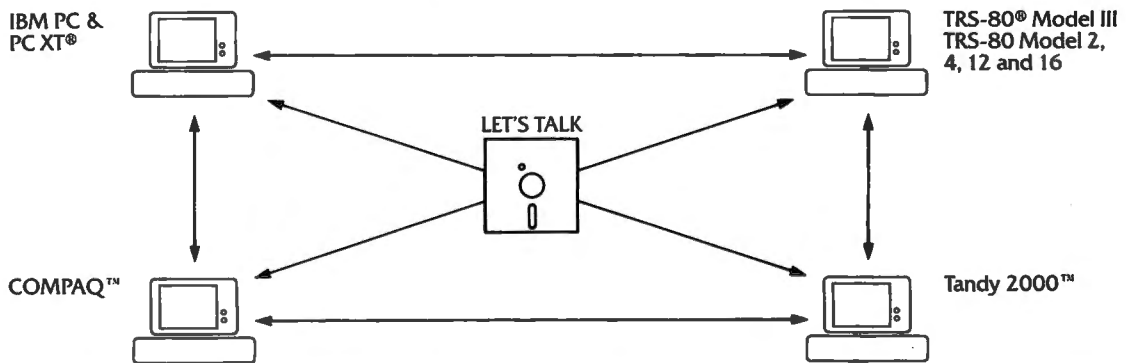

**LET'S TALK CLOSES THE COMMUNICATIONS GAP BETWEEN TODAY'S POPULAR PERSONAL COMPUTERS.**

LET'S TALK is a complete package for fully supported communications between any of these computers. In any direction. Without additional expense.

LET'S TALK is a simple, straightforward program that transfers ASCII data files, including BASIC and VisiCalc®, from one computer to

another. Precisely. Easily. Without professional, expensive data processing expertise.

LET'S TALK allows two computers to communicate directly with each other in a "conversational mode" when not actually transferring data. And, LET'S TALK can send or retrieve files of any size from unattended computers, at three different speeds.

**GROWTH AND EXPANSION REQUIRE OPEN COMMUNICATION. LET'S TALK.**



**Making dollars and sense out of information.**

Now available at Radio Shack stores through Express Order Software Program.

TRS-80 is a registered trademark of Tandy Corporation. Tandy 2000 is a trademark of Tandy Corporation. Visi Calc is a registered trademark of VisiCorp. IBM PC and PC XT are registered trademarks of IBM Corporation. COMPAQ is a trademark of Compaq Computer Corporation.

a division of the goodman group, Inc. 12900 Preston Rd., Dallas, Texas 75230 (214) 239-6085  
LET'S TALK includes all diskettes for each of the above computers. Suggested retail price \$179.00 + \$5.00 shipping



# FAST HARD DISK BACK UP

**FOR TANDY  
II/12/16/6000  
(TRSDOS™, XENIX®,  
or CP/M®)**

How much would you lose if a power failure, hardware glitch, or other disaster damaged or destroyed your hard disk data files? How long would it take to reconstruct them? How would the loss affect your business?

**SNAPBACK** can't prevent a disaster. But it can back up your hard disk so quickly and inexpensively that you can always be prepared for the worst. This is possible because SNAPBACK is...

- **FAST.** It copies 1.5 (Mod. II) to 2.4 (Mod. 12/16/6000) Mbytes of data per minute to 8" floppy disks. Thus, you can back up a 15 Mbyte drive in as little as 7-8 minutes.
- **FLEXIBLE.** It works with any Model II/12/16/6000, any 8.7/12/15/35 Mbyte Tandy drive, and any XENIX, TRSDOS, and/or CP/M data.
- **EASY.** Its menus make it a snap to back up or restore your data (with optional verification).
- **INEXPENSIVE.** It only costs \$125.00.

If you value your data, you need SNAPBACK. It's the best insurance available.

The SNAPBACK package includes two bootable disks and complete documentation. To order, phone or write today.

(Mastercard, VISA, Check, or UPS COD (\$2) accepted. Add \$7.50 for handling/shipping. CA residents add 6% sales tax.)



**PICKLES & TROUT®**  
PO. BOX 1206  
GOLETA, CA 93116  
**(805) 685-4641**

XENIX® Microsoft Corp.  
CP/M® Digital Research, Inc.  
TRSDOS™ Tandy Corp.

## THE NEXT STEP

Listing continued

```

00290 SVC @DECHX ;Convert row to hex
00291 PUSH BC ;And save
00292 INC HL ;Skip comma
00293 SVC @DECHX ;Convert column to hex
00294 LD L,C ;Column to L
00295 POP BC ;Recover row
00296 LD H,C ;Row to H
00297 OR A ;Reset Carry Flag
00298 RET ;And return
00299 ;
00300 ; Put present parameters in display strings
00301 ;
00302 PARM_DEC EQU $
00303 PUSH HL ;Save row/col to convert
00304 LD L,H ;Move row to L
00305 CALL CONVL ;Convert & store row
00306 RL40 EQU $-2
00307 LD A,', ' ;Display character
00308 LD (DE),A ;To string
00309 INC DE ;Point to next area
00310 POP HL ;Recover row/col
00311 CONVL LD H,0 ;Blank H value
00312 LD A,' ' ;Blanking space
00313 LD B,2 ;Maximum string length
00314 CALL @6FAH ;Into middle of @HEXDEC
00315 RET
00316 ;
00317 ; Display messages
00318 ;
00319 PROMPT1 DEFM 'Window Commands:' ;29 spaces
00320 DEFM ' '
00321 DEFM 'Current Window Settings:'
00322 DEFM LF
00323 DEFM '<O>pen, <C>lose, <D>os Command' ;16 spaces
00324 DEFM ' '
00325 DEFM 'Parameters: '
00326 TOPW DEFM ' '
00327 BOTW DEFM ' '
00328 DEFM LF
00329 DEFM '<R>eturn to previous program' ;13 spaces
00330 DEFM ' '
00331 DEFM 'Windows now saved: '
00332 OPNW DEFM ' '
00333 DEFM CR
00334 ;
00335 DOSMSG DEFM '{Press <BREAK> to return}'
00336 DB LF
00337 DEFM 'Dos command? '
00338 DB ETX
00339 ;
00340 TOPMSG DEFM 'New top left corner (row,col): '
00341 DB ETX
00342 ;
00343 BOTMSG DEFM 'Bottom right corner (row,col): '
00344 DB ETX
00345 ;
00346 FRMSG DEFM 'ASCII Frame character (0 for none): '
00347 DB ETX
00348 ;
00349 INBUF$ DS 80
00350 OVRBUF DS 500H
00351 FLTEND EQU $-1 ;End of filter
00352 FLTLEN EQU $-BEGIN ;Length of filter
00353 ;
00354 ;*****
00355 ;
00356 ; Installation section
00357 ;
00358 ;*****
00359 ;
00360 INIT PUSH DE ;Save DCB ptr
00361 LD (MODDCB),DE ;Stuff into filter
00362 LD HL,SGNON ;HL=> Sign-on message
00363 SVC @DSPLY ;Display on screen
00364 LD DE,MODNAME ;DE=>Window SVC name
00365 SVC @GTMOD ;Find SVC
00366 JR Z,VIASET ;Go if found
00367 LD HL,NO_SVC ;HL=>message
00368 ERR_OUT SVC @DSPLY ;Display error message
00369 LD HL,-1 ;Set extended error
00370 SVC @EXIT ;And leave
00371 ;
00372 ; Installed with SET command?
00373 ;
00374 VIASET SVC @FLAGS ;Point IY to flags
00375 BIT 3,(IY+'C'-'A') ;Test bit 3 of CFLAG$
00376 JR NZ,SETHI ;Go if SET used
00377 LD HL,SETMSG ;HL=>"Use SET"
00378 JR ERR_OUT ;And leave
00379 ;
00380 ; Reset HIGH$ and prepare to relocate filter
00381 ;
00382 SETHI LD HL,0 ;Get current value
00383 LD B,L ;B=0 >> select HIGH$
00384 SVC @HIGH$
00385 LD (OLDHI),HL ;Save in filter header
00386 JR Z,RELOC ;Go if no error
00387 LD HL,NOMEM ;HL=> No memory msg
00388 JR ERR_OUT ;Report error & leave
00389 ;
00390 ; Move filter to high memory and protect
00391 ;
00392 RELOC LD IY,RELTAB ;IY=> Relocation table
00393 LD DE,FLTEND ;DE=> End of filter
00394 XOR A ;Reset Carry Flag

```

Listing continued



## THE NEXT STEP

Listing continued

```

00395 SBC HL,DE ;Calculate distance to move
00396 PUSH HL ; and transfer to
00397 POP BC ; BC register pair
00398 RELOC1 LD L,(IX+0) ;Get address to change
00399 LD H,(IX+1) ; in HL
00400 LD A,H ;Pick up MSB
00401 OR A ;Is it 0?
00402 JR Z,MOVE ;Yes -- go
00403 LD E,(HL) ;Move contents
00404 INC HL ; of address to
00405 LD D,(HL) ; DE reg. pair
00406 EX DE,HL ;HL has value to change
00407 ADD HL,BC ;Add the offset
00408 EX DE,HL ;New value back to DE
00409 LD (HL),D ;Put it back
00410 DEC HL ; in the
00411 LD (HL),E ; program
00412 INC IX ;Bump IX to next
00413 INC IX ; entry in table
00414 JR RELOC1 ;Repeat until done
00415 ;
00416 ; Move module to high memory and protect
00417 ;
00418 MOVE LD DE,(OLDHI) ;DE==>Destination address
00419 LD HL,PLTEND ;HL==>Current end of filter
00420 LD BC,PLTLEN ;BC = length of module
00421 LDDM ;Move it
00422 EX DE,HL ;Move new HIGH$ to HL
00423 LD B,0 ;Select HIGH$
00424 SVC @HIGH$;Set new HIGH$ value
00425 INC HL ;HL==>filter entry point
00426 ;
00427 ; Set type and address in filter's DCB
00428 ;
00429 POP IX ;Get DCB addr off stack
00430 LD (IX),@1000101B ;Set as FILTER capable of
00431 ; @GET & @CTL
00432 LD (IX+1),L ;LSB of filter address
00433 LD (IX+2),H ;MSB of filter address
00434 LD HL,SUCCESS ;HL==> Success message
00435 SVC @DSPLY ;Show success
00436 LD HL,0 ;Bact to TRSDOS via SET
00437 RET
00438 ;
00439 ; Messages
00440 ;
00441 MODNAME DEFM 'WS' ;Window SVC module name
00442 DE 0
00443 SGNON DEFM 'Windowing System User Filter'
00444 DE CR
00445 NO_SVC DEFM 'Window SVC not found -- installation aborted'
00446 DE CR
00447 SETMSG DEFM 'Filter must be installed with SET command'
00448 DE CR
00449 NOMEM DEFM 'High memory not available for installation'
00450 DE CR
00451 SUCCESS DEFM 'Installation successfully completed'
00452 DE LF
00453 DEFM 'Use FILTER command to connect to *KI'
00454 DE LF
00455 DEFM 'Then use <CTRL><W> to invoke window commands'
00456 DE CR
00457 ;
00458 ; Relocation table
00459 ;
00460 RELTAB DEFW RL01,RL02,RL03,RL04,RL05,RL06,RL07,RL08
00461 DEFW RL09,RL10,RL11,RL12,RL13,RL14,RL15,RL16
00462 DEFW RL17,RL18,RL19,RL20,RL21,RL22,RL23,RL24
00463 DEFW RL25,RL26,RL27,RL28,RL29,RL30,RL31,RL32
00464 DEFW RL33,RL34,RL35,RL36,RL37,RL38,RL39,RL40
00465 DEFW 0000
00466 ;
00467 END INIT

```

End

Circle 422 on Reader Service card.

## Word Processing SIMPLIFIED

for SuperSCRIPSIT

### IDEAL CLASSROOM TEXT FOR WORD PROCESSING

The simple instruction book use with TRS-80 III, IV, IVP

**CLEAR, SIMPLE, EASY**

- home
- office
- education

All you need is a super SCRIPSIT diskette.

**ORDER NOW**

Send check or **MO** for  
\$19.95

includes shipping to:

**Kelly Enterprises**

P.O. Box 247

Holt, MI

48842-0247

Circle 137 on Reader Service card.

**FOR TRS-80 MODELS 1, 3, 4, 4P  
IBM PC/XT, AT&T 6300, ETC.**

## THE COMPLETE FORTH GETS A MAJOR UPDATE: MMSFORTH V2.4

- A total software environment: custom drivers for printer, video and keyboard improve speed and flexibility. (New TRS-80 M.4 version, too!)
- Common SYS format gives you a big 395K (195K single-sided) per disk, plus a boot track!
- Common wordset (79-Standard plus MMSFORTH extensions) on all supported computers.
- Common and powerful applications programs available (most with MMSFORTH source code) so you can use them compatibly (with the same data disks) across all supported computers.
- Very fast compile speeds and advanced program development environment.
- A fantastic full-screen Forth Editor: Auto-Find (or -Replace) any word (forward or back), compare or Pairs-Edit any two ranges of blocks, much more.
- Temporary dictionary areas.
- QUANs, VECTs, vectored I/O, and many more of the latest high-performance Forth constructs.
- Manual and demo programs are bigger and better than ever!
- Same thorough support: Users Newsletter, User Groups worldwide, telephone tips, Full consulting services.
- Personal Licensing (one person on one computer) is standard. Corporate Site Licensing and Bulk Distribution Licensing available to professional users.

# MMS FORTH

**IT'S BETTER THAN EVER.**

The total software environment for IBM PC/XT, TRS-80 Model 1, 3, 4 and close friends.

- Personal License (required):  
MMSFORTH V2.4 System Disk . . . . \$179.95  
(TRS-80 Model 1 requires lowercase, DDEN, 1 40-track drive.)
- Personal License (additional modules):  
FORTHCOM communications module . . . \$ 49.95  
UTILITIES . . . . . 49.95  
GAMES . . . . . 39.95  
EXPERT-2 expert system . . . . . 69.95  
DATAHANDLER . . . . . 59.95  
DATAHANDLER-PLUS (PC only, 128K req.) . 99.95  
FORTHWRITE word processor . . . . . 99.95
- Corporate Site License  
Extensions . . . . . from \$1,000  
Bulk Distribution . . . from \$500/50 units.
- Some recommended Forth books:  
STARTING FORTH (programming) . . . . 19.95  
THINKING FORTH (technique) . . . . . 15.95  
BEGINNING FORTH (re MMSFORTH) . . . 18.95

Shipping/handling & tax extra. No returns on software. Ask your dealer to show you the world of MMSFORTH, or request our free brochure.

**MILLER MICROCOMPUTER SERVICES**  
61 Lake Shore Road, Natick, MA 01760  
(617) 653-6136



# SAVE A BUNDLE

**WITH ONE OF OUR BUNDLES**

We have put together special bundles of software just in time to save you a bundle of money. Didn't you ever wonder why CP/M was so popular? The reason is the software availability. All programs (except EP) are for the Model 4/4P and have been optimized to install and run without hassle. For example, we have memory-mapped WordStar® and it runs circles around the standard version available elsewhere. We also added printer drivers for the Daisywheel II and the DMP-2100. Our CP/M® 2.2 is the best around. Read the reviews. You know the programs. You know the prices. This is the years' best value. You owe it to yourself to let these CP/M® programs and thousands of others (many in the public domain) start serving your needs.

**Bundle #1**  
 WordStar®  
 MailMerge®  
 SpellStar™  
 StarIndex™  
 Montezuma Micro CP/M®  
**\$299**  
 Delivered  
 RETAIL VALUE \$1009

**Bundle #5**  
 Electric Pencil™  
 Red Pencil™  
 Blue Pencil™  
**\$149**  
 Delivered  
 Works with TRSDOS, NEWDOS-80,  
 DOSPLUS and MULTIDOS  
 (Model 1,3,4)  
 RETAIL VALUE \$240

**Bundle #2**  
 WordStar®  
 DataStar™  
 ReportStar™  
 CalcStar™  
 Montezuma Micro CP/M®  
**\$399**  
 Delivered  
 RETAIL VALUE \$1354

**Bundle #3**  
 WordStar®  
 MailMerge®  
 SpellStar™  
 StarIndex™  
 DataStar™  
 ReportStar™  
 CalcStar™  
 Montezuma Micro CP/M®  
**\$499**  
 Delivered  
 RETAIL VALUE \$1699

**Bundle #4**  
 WordStar®  
 MailMerge™  
 SpellStar™  
 StarIndex™  
 dBASE II®  
 TurboPascal™  
 Montezuma Micro CP/M®  
**\$599**  
 Delivered  
 RETAIL VALUE \$1553

## Save A Bundle on these books and disks

Take advantage of our volume discounts. Buy any three items from this list and deduct \$5 from your total order. Buy four...deduct \$10. Buy five...deduct \$15. Buy six...deduct \$20 and so on. Buy a bunch, save a bundle. Please add \$1 each for shipping. Add \$5 to orders under \$50 for handling.



- TRS-80 Disk & Other Mysteries.** The "How to" book of data recovery for the TRS-80 Model I disk operating system. 128 pages. Retail \$22.50 **Now \$18**
- Microsoft BASIC Decoded & Other Mysteries.** The complete guide to Level II and BASIC. 312 pages. Retail \$29.95 **Now \$24**
- The Custom TRS-80 & Other Mysteries.** The complete guide to customizing TRS-80 Hardware and Software. 336 pages. Retail \$29.95 **Now \$24**
- BASIC Faster & Better & Other Mysteries.** The complete guide to BASIC programming tricks and techniques. 290 pages. Retail \$29.95 **Now \$24**
- BASIC Faster & Better Library Disk.** Contains 121 functions, subroutines and user routines. Search merge, compare and listing routines plus array handlers, BASIC overlays and video drivers. Retail \$19.95 **Now \$16**
- BASIC Faster & Better Demonstration Disk.** Contains 32 demos of the Library Disk contents above. Retail \$19.95 **Now \$24**
- BASIC Disk I/O Faster & Better & Other Mysteries.** Programming tips and techniques to store/retrieve data from disk. 432 pages. Retail \$29.95 **Now \$24**
- BASIC Disk I/O Faster & Better Demonstration Disk.** All of the major demo programs and library of disk I/O subroutines in 25 BASIC programs. Random, Indexed Sequential and TREESAM file handlers included. Retail \$29.95 **Now \$24**
- Machine Language Disk I/O & Other Mysteries.** A guide to machine language disk I/O for the TRS-80. 288 pages. Retail \$29.95 **Now \$24**
- TRSDOS 2.3 Decoded & Other Mysteries.** Detailed explanation of the Model I disk operating system. 298 pages. Retail \$29.95 **Now \$24**
- How To Do It On The TRS-80.** A complete applications guide to the TRS-80 Model I, II, III, 100, and Color Computer. 352 pages. Retail \$29.95 **Now \$24**
- The Custom Apple & Other Mysteries.** Who cares? Retail \$29.95 **Now \$19**

©1984 by Montezuma Micro WordStar®, SpellStar™, StarIndex™, MailMerge®, DataStar™, ReportStar™ and CalcStar™ belong to MicroPro® International Corporation. CP/M® belongs to Digital Research Inc. dBASE II® belongs to Ashton-Tate, Inc. All the Pencils™ belong to Michael Shrayner. Turbo Pascal™ belongs to Borland International.



# MONTEZUMA MICRO

214-339-5104  
 Redbird Airport, Hangar #8  
 P.O. Box 32027  
 Dallas, Texas 75232 "WE KEEP YOU RUNNING"



**ORDER NOW . . . TOLL FREE**  
**800-527-0347**  
**800-442-1310**

The Toll Free lines are for orders only  
 Specifications subject to change without notice





# MONTAZUMA

P.O. Box 2169  
Camp Verde (Lizard Flats)  
Arizona 86322

"WE KEEP YOU RUNNING"

### COMPUTERS

|                                             |         |
|---------------------------------------------|---------|
| 25-1000 1st Model 1000 128K RAM IBM Clone   | \$ 1025 |
| 25-1089 2nd Model 1000 64K Ram Radio Shack  | 1059    |
| 25-1080 64K Model 4 Portable, 2dr & RS232C  | 899     |
| 25-3127 64K Extended BASIC Color Computer 2 | 179     |
| 25-3134 16K Color Computer 2                | 59      |
| 25-3136 16K Extended BASIC Color Computer 2 | 135     |
| 25-3589 Pocket Computer 3 with 4K RAM       | 85      |
| 25-3601 Pocket Computer 2                   | 89      |
| 25-3650 Pocket Computer 4                   | 89      |
| 25-3601 Model 100 8K Portable Computer      | 359     |
| 25-3602 Model 100 24K Portable Computer     | 539     |
| 25-4004 Model 110 4K Portable Computer      | 239     |
| 25-5103 Model 2000 2-drive, 128K            | 2124    |
| 25-5104 Model 2000 W/Hard Disk and 256K     | 3358    |
| 25-6021 Model 8000 2dr 512K                 | 3824    |
| 25-6022 Model 8000 HD 512K                  | 4574    |
| 25-6050 DT-1 Terminal                       | 499     |
| 25-6052 DT-100 Terminal                     | 675     |

### C/ITOH

|                                                      |      |
|------------------------------------------------------|------|
| 3520 350cps Parallel IBM Compatible                  | 1995 |
| 8510BP1 120cps Friction/Tractor, Parallel, IBM Comp  | 349  |
| 8510SP Hot Dot, 180cps, Real Fast                    | 495  |
| 8510SCP Color High Speed Printer                     | 549  |
| 1550P Prowriter 2, 120cps, for Wide Paper, Parallel  | 525  |
| 1550SP Hot Dot, 180cps, Real Fast & Wide             | 675  |
| F10-40 Starwriter, 40cps Daisywheel                  | 899  |
| F10-55 Printermaster, 55cps Daisywheel, FAST         | 1099 |
| F10-B-Directional Tractor with Plastic Cover         | 210  |
| F10 Electric Single Bin Sheet Feeder, Inst. Required | 775  |
| F10 Mechanical Single Bin Sheet Feeder               | 499  |
| GX-100 Goria Banners, 50cps                          | 139  |

We have just discovered for most every printer we sell. Be sure to order one with your new printer to keep it like new.

### MODEMS

|                                            |     |
|--------------------------------------------|-----|
| 25-1063 Model 1000 Int. Modem              | 153 |
| 25-1084 Model 4P Modem Board               | 127 |
| 25-1173 DC Modem II                        | 169 |
| 25-1174 Acoustic Coupler Modem             | 85  |
| 25-1175 DC Modem                           | 127 |
| 76-1176 DC-2212 High Speed Modem           | 339 |
| Anchor Mark I Modem, 300 Baud with cable   | 74  |
| Anchor 300/1200 Baud Modem with cable & PS | 259 |
| Hayes Smartmodem, 300 Baud                 | 239 |
| Hayes Smartmodem, 1200 Baud                | 525 |

### CABLES

We manufacture a great number of different cable assemblies to connect most anything to anything else. Call us with your specific needs. We probably have it in the shelf. All at discount prices, of course.

### PERIPHERALS

|                                                    |      |
|----------------------------------------------------|------|
| LW-80 2dr cabinet w/half high drives               | 449  |
| 12" Green Non-Glare Video Monitor                  | 79   |
| 12" Amber Non-Glare Video Monitor                  | 85   |
| Video cable for Model 1 keyboard-to-monitor        | 7    |
| 25-3010 Model 1000 Mouse & Clock/Calendar          | 85   |
| 25-3010 VM-3 Mouse & Clock                         | 157  |
| 25-3040 Model 1200 Monochrome Adapter              | 169  |
| 25-3043 Model 1200 Graphics Display Adapter        | 229  |
| 25-3044 Model 1200 Technic Graphics Master         | 499  |
| 25-0511 Genuine RS Parity/Noise Anti-Glare Device  | 25   |
| 25-1085 Model 4P Carrying Case                     | 21   |
| 25-1131 Model 1/4 5MB Hard Disk Secondary          | 1299 |
| 25-1133 Model 3 15MB Hard Disk                     | 85   |
| 25-1134 Model 1/4 5MB Hard Disk Inst. Kit          | 68   |
| 25-1183 Model 100 Bar Code Reader                  | 85   |
| 25-1185 Color Computer Keyboard                    | 69   |
| 25-1197 Mouse for Model 2000                       | 85   |
| 25-1198 Serial to Parallel Converter               | 85   |
| 25-1208 CCR-81 Cassette Tape Recorder              | 41   |
| 25-1209 CCR-42 Cassette Tape Recorder              | 41   |
| 25-1326 Anti-Grain Panel, Model 2/12/16            | 11   |
| 25-1342 Clear Keypad for Model 3/4                 | 11   |
| 25-1410 Model 100 Modem Cable                      | 11   |
| 25-1429 Automatic Power Strip/Surge Protector      | 42   |
| 25-1451 Non-Automatic Power Strip/Filter           | 42   |
| 25-1457 Anti-Grain Panel, Model 1/3/4              | 11   |
| 25-3002 Color Computer Deluxe RS-232C Kit          | 69   |
| 25-3007 Color Computer Carrying Case               | 17   |
| 25-3008 Color Computer Joysticks, Per Pair         | 21   |
| 25-3023 Color Computer Deluxe Joystick/Cable       | 33   |
| 25-3024 Color Computer Multi-Port Interface        | 89   |
| 25-3025 Color Computer Mouse                       | 43   |
| 25-3503 PC 1 Cassette Interface                    | 13   |
| 25-3508 PC 1 Carrying Case                         | 13   |
| 25-3608 PC 1 Carrying Case                         | 25   |
| 25-3616 PC 2 RS-232C Interface                     | 89   |
| 25-3615 PC 2 4K RAM Module                         | 118  |
| 25-3616 PC 2 8K RAM Module                         | 118  |
| 25-3654 PC 4 Cassette Interface                    | 33   |
| 25-3653 PC 4 1K Ram Module                         | 118  |
| 25-3654 PC 4 Carrying Case                         | 6    |
| 25-3804 Model 100 AC Adapter                       | 5    |
| 25-3805 Model 100 Acoustic Coupler                 | 34   |
| 25-3809 Model 100 Carrying Case                    | 42   |
| 25-3811 Model 100 Soft Carrying Case               | 34   |
| 25-3812 Model 100 Legs (pair)                      | 24   |
| 25-4154 Model 1200 External Hard Disk Kit          | 244  |
| 25-4155 Model 2/3/4/12/16 15MB Primary Hard Disk   | 1695 |
| 25-4156 Model 2/3/4/12/16 15MB Secondary Hard Disk | 1271 |
| 25-4157 Model 2/12/16 Installation Kit for 25-4155 | 29   |
| 25-5111 Model 2000 VM-1 Modem Monitor              | 169  |
| 25-5112 Model 2000 CM-1 Color Monitor              | 552  |

### SUPPLIES

|                                                   |       |
|---------------------------------------------------|-------|
| 5.25" 5DD Diskettes, Pack of 10, 1 Year Guarantee | \$ 15 |
| 5.25" 5DD Diskettes, Pack of 10, 1 Year Guarantee | 19    |
| 8" 5DD Diskettes, Pack of 10, 1 Year Guarantee    | 29    |
| 8" 5DD Diskettes, Pack of 10, 1 Year Guarantee    | 34    |
| 5.25" Floppy 7.5 Disk                             | 4     |
| 8.5" x 11" Tractor Paper, 20lb, 2900 Sheets       | 25    |
| 14" x 11" Tractor Paper, 20lb, 2900 Sheets        | 35    |
| 5.25" or 8" Head Cleaning Kit                     | 9     |

### PRINTERS & ACCESSORIES

|                                                   |      |
|---------------------------------------------------|------|
| 25-1192 GGP-115 Color Graphics Printer            | 169  |
| 25-1196 GT-116 Graphics Pad                       | 90   |
| 25-1290 DWP-110 2400 dpi Printer                  | 583  |
| 25-1252 DMP-500 220cps Printer                    | 1099 |
| 25-1254 DMP-200 120cps Printer                    | 424  |
| 25-1255 DMP-120 120cps Dual Mode Printer          | 424  |
| 25-1257 DWP-210 Daisywheel Printer                | 85   |
| 25-1261 TP-10 Thermal Matrix Printer              | 85   |
| 25-1268 GCP-220 Color Ink Jet Printer             | 594  |
| 25-1269 PTC-64 Printer Controller (Buffer)        | 212  |
| 25-1270 DWP-510 Daisywheel printer                | 1270 |
| 25-1271 DMP-110 50cps Triple Mode Printer         | 339  |
| 25-1274 DMP-2100 160cps Dual-Mode Printer         | 1695 |
| 25-1275 NEWI TRP-100 Printer                      | 299  |
| 25-1276 DMP-105 New Cheep Printer                 | 169  |
| 25-1277 DMP-430 New Not So Cheep Printer          | 765  |
| 25-1443 B-Directional Tractor for DWP-210         | 144  |
| 25-1443 B-Directional Tractor for DWP-210         | 99   |
| 25-1447 B-Directional Tractor for Daisywheel II   | 188  |
| 25-1448 Single Bin Sheet Feeder for Daisywheel II | 570  |
| 25-1455 Acoustic Coupler                          | 339  |
| 25-1459 B-Directional Tractor for DWP-410         | 63   |
| 25-1401 Model 1/3/4/4P Printer Cable              | 16   |
| 25-1408 RS-232C Printer Cable                     | 16   |
| 25-1409 Model 100 Printer Cable                   | 13   |
| 25-4401 Model 2/12/16/2000 Printer Cable          | 26   |
| 25-1490 10 RS-232C Printer Cable                  | 29   |
| 25-1491 RS-232C Cable                             | 33   |
| 25-1492 50 RS-232C Cable                          | 46   |
| 25-1493 100 RS-232C Cable                         | 76   |
| 25-1495 RS-232C Cable External Adapter            | 29   |
| 25-1496 SW-302 Parallel Printer Switch            | 102  |
| 25-1497 SW-303 RS-232C Selector Switch            | 128  |
| 25-3650 PC 2 Printer                              | 45   |
| 25-3652 PC 4 Printer                              | 68   |

### RIBBONS

We have more ribbons than you do. Way too many types to list here. Add them to your order now. They're cheap too.

## MONTAZUMA'S REVENGE

### MODEL 3 UPGRADE

#### 112K - CP/M - 80 COLUMN

This month Monte offers the deal of the year. The Holmes VID-80 is the only plug in printed circuit board which expands the Mod 3 display to 24 lines of 80 characters and allows operation of the CP/M 2.2 operating system with a 56K TPA. Both 80 x 24 and 84 x 16 modes are available from TRSDOS and BASIC. Reads and writes 18 different disk formats (Kaypro, Osborne, etc.). A total of 112K of RAM. The extra 49K can be set up as a RAM disk through software routines that are furnished with the supplied CP/M operating system. The VID-80 comes complete with easy to follow installation instructions and operational documentation. No trace cuts or soldering required. Guaranteed for one year parts and labor. Monte can ship this today.

### MONTE'S SPECIAL PRICE ..... \$ 279

Add WordStar 3.3 ready to run for \$ 100

"WE KEEP YOU RUNNING"

### SOFTWARE

Note: It is Radio Shack policy that not all multiple-computer software packages contain disks for all models. Optional disks are available at slight extra charge. Be sure to ask for details when you order.

|                                                  |     |
|--------------------------------------------------|-----|
| NEWI CP/M 2.2 by Montezuma Micro For The Model 4 | 169 |
| Rated best by actual test. Get the good one      | 169 |
| NEWI CP/M Hard Disk Driver with Backup & Restore | 30  |
| 25-0312 TRSDOS 1.3 For The Model 3               | 12  |
| 25-0313 TRSDOS 6.x For The Model 4               | 12  |
| 25-0315 TRSDOS 6.2 Utility Disk                  | 34  |
| 25-0316 TRSDOS 6.2 Disk Doc Ref Card             | 34  |
| 25-0413 Disk Drive Analyzer. Why pay more?       | 26  |
| 25-1507 Model 1/3 Stockpack                      | 42  |
| 25-1510 Model 1/3 Trendex                        | 51  |
| 25-1511 Model 3 Home Accountant                  | 85  |
| 25-1512 Model 3 Target PlannerCalc               | 85  |
| 25-1513 Model 3/4 Class. Spectacular             | 42  |
| 25-1514 Model 3 Portfolio Manager                | 169 |
| 25-1515 pfile for Model 3                        | 106 |
| 25-1516 pfile for Model 3                        | 106 |
| 25-1517 pfile for Model 4                        | 85  |
| 25-1518 pfile for Model 4                        | 85  |
| 25-1520 Model 4 VisCalc                          | 85  |
| 25-1521 Model 3 VisCalc Business Forecast        | 89  |
| 25-1522 Model 3/4 Financial Forecast             | 89  |
| 25-1530 Model 4 Multipan                         | 169 |
| 25-1538 NEWI Model 4 Apartment Management        | 255 |
| 25-1539 Model 4/5 Project Manager                | 169 |
| 25-1540 Model 3/4 General Ledger                 | 169 |
| 25-1541 Model 3/4 Accounts Receivable            | 169 |
| 25-1542 Model 3/4 Accounts Payable               | 169 |
| 25-1543 Model 3/4 Payroll                        | 169 |
| 25-1544 Model 3/4 Invoice Writer                 | 42  |
| 25-1545 NEWI Model 3/4 Inventory Control         | 169 |
| 25-1559 Model 3/4 Financial Forecast             | 169 |
| 25-1560 Fixed Assets                             | 169 |
| 25-1562 Model 1/3 Profile                        | 36  |
| 25-1563 Model 1/3 Formation                      | 36  |
| 25-1564 Model 1/3 Mailgram                       | 14  |
| 25-1565 Model 1/3 Microfile                      | 23  |
| 25-1568 Model 1/3 Medical Office Systems         | 23  |
| 25-1569 Model 3 VisCalc Enhanced Version         | 85  |
| 25-1577 Model 1/3 Surveying                      | 85  |
| 25-1579 Model 1/3 Real Estate                    | 85  |
| 25-1580 Model 1/3 Project Manager                | 85  |
| 25-1581 Model 1/3 Personnel Manager              | 85  |
| 25-1582 Model 1/3 Time Manager                   | 85  |
| 25-1583 Model 3 Checkwriter                      | 127 |
| 25-1585 Model 3 Business Checkwriter             | 127 |
| 25-1588 Model 1/3 Videotex Plus                  | 127 |
| 25-1589 Model 3 MICRO/Counter                    | 127 |
| 25-1590 Model 1/3 SuperDISK                      | 89  |
| 25-1591 Model 1/3 Scripstat Dictionary           | 89  |
| 25-1592 Model 3 Profile Plus                     | 169 |
| 25-1593 Model 3 Profile Plus LDOS/HD Version     | 294 |

|                                                        |     |
|--------------------------------------------------------|-----|
| 25-1594 Model 3 Desktop/Plan-80                        | 139 |
| 25-1595 SuperSCRIPT For The Model 4                    | 169 |
| 25-1596 SCRIPSTAT For The Model 4                      | 148 |
| 25-1597 Model 3 Business Graphics Pak                  | 85  |
| 25-1598 Model 4 Vidotex Plus                           | 185 |
| 25-1600 Dictionary for the Model 4                     | 4   |
| 25-1630 NEWI TKI Solver for the Model 4                | 255 |
| 25-1631 NEWI Model 4 Profile                           | 212 |
| 25-1922 Model 3/4 Orchestra 90                         | 68  |
| 25-2011 Model 1/3 EDAS, Tape Version                   | 29  |
| 25-2012 3/4 Assembly Language Development Course, Disk | 126 |
| 25-2013 EDAS, Disk Version, Model 1/3                  | 29  |
| 25-2015 Model 3 Instruction Tapes                      | 21  |
| 25-2017 Model 3 Assembly Language Course, Tape         | 34  |
| 25-2018 Model 3 Assembly Language Course, Disk         | 34  |
| 25-2019 TRSDOS 6.x Training Course                     | 49  |
| 25-2022 Power Tool for the Model 1/3                   | 42  |
| 25-2023 Dot Plot for the Model 1/3                     | 47  |
| 25-2025 NEWI Construction for the Model 4              | 127 |
| 25-2026 NEWI COBOL Query for the Model 4               | 127 |
| 25-2027 NEWI Graphics 90 for something                 | 134 |
| 25-2191 Model 3 FORTRAN                                | 85  |
| 25-2200 Model 1 FORTRAN                                | 85  |
| 25-2203 Model 1/3 COBOL                                | 169 |
| 25-2204 Model 1/3 Compiler BASIC                       | 126 |
| 25-2205 Micro PILOT                                    | 126 |
| 25-2210 Model 3 BASCOM                                 | 169 |
| 25-2211 Model 3 BASCOM                                 | 212 |
| 25-2212 Alcor PASCAL For The Model 4                   | 212 |
| 25-2213 Model 1 LIDOS (LSI version)                    | 69  |
| 25-2214 Model 1 Assembly Language Course, Disk         | 69  |
| 25-2216 CP/M Plus For The Model 4                      | 127 |
| 25-2217 Model 100 Learning                             | 127 |
| 25-2218 Model 4 Double Duty (128K req.)                | 59  |
| 25-2219 Model 4 PILOT                                  | 101 |
| 25-2221 Color Computer LOGO, Disk                      | 85  |
| 25-2222 Color Computer LOGO ROM Pack                   | 43  |
| 25-2223 Color Computer LOGO ROM Pack                   | 43  |
| 25-2224 Color Computer LOGO ROM Pack                   | 43  |
| 25-2225 BASIC '05 For The Color Computer               | 59  |
| 25-2226 BASIC '05 For The Color Computer               | 59  |
| 25-2227 BASIC '05 For The Color Computer               | 59  |
| 25-2228 BASIC '05 For The Color Computer               | 59  |
| 25-2229 BASIC '05 For The Color Computer               | 59  |
| 25-2230 BASIC '05 For The Color Computer               | 59  |
| 25-2231 BASIC '05 For The Color Computer               | 59  |
| 25-2232 BASIC '05 For The Color Computer               | 59  |
| 25-2233 BASIC '05 For The Color Computer               | 59  |
| 25-2234 BASIC '05 For The Color Computer               | 59  |
| 25-2235 BASIC '05 For The Color Computer               | 59  |
| 25-2236 BASIC '05 For The Color Computer               | 59  |
| 25-2237 BASIC '05 For The Color Computer               | 59  |
| 25-2238 BASIC '05 For The Color Computer               | 59  |
| 25-2239 BASIC '05 For The Color Computer               | 59  |
| 25-2240 BASIC '05 For The Color Computer               | 59  |
| 25-2241 BASIC '05 For The Color Computer               | 59  |
| 25-2242 BASIC '05 For The Color Computer               | 59  |
| 25-2243 BASIC '05 For The Color Computer               | 59  |
| 25-2244 BASIC '05 For The Color Computer               | 59  |
| 25-2245 BASIC '05 For The Color Computer               | 59  |
| 25-2246 BASIC '05 For The Color Computer               | 59  |
| 25-2247 BASIC '05 For The Color Computer               | 59  |
| 25-2248 BASIC '05 For The Color Computer               | 59  |
| 25-2249 BASIC '05 For The Color Computer               | 59  |
| 25-2250 BASIC '05 For The Color Computer               | 59  |
| 25-2251 BASIC '05 For The Color Computer               | 59  |
| 25-2252 BASIC '05 For The Color Computer               | 59  |
| 25-2253 BASIC '05 For The Color Computer               | 59  |
| 25-2254 BASIC '05 For The Color Computer               | 59  |
| 25-2255 BASIC '05 For The Color Computer               | 59  |
| 25-2256 BASIC '05 For The Color Computer               | 59  |
| 25-2257 BASIC '05 For The Color Computer               | 59  |
| 25-2258 BASIC '05 For The Color Computer               | 59  |
| 25-2259 BASIC '05 For The Color Computer               | 59  |
| 25-2260 BASIC '05 For The Color Computer               | 59  |
| 25-2261 BASIC '05 For The Color Computer               | 59  |
| 25-2262 BASIC '05 For The Color Computer               | 59  |
| 25-2263 BASIC '05 For The Color Computer               | 59  |
| 25-2264 BASIC '05 For The Color Computer               | 59  |
| 25-2265 BASIC '05 For The Color Computer               | 59  |
| 25-2266 BASIC '05 For The Color Computer               | 59  |
| 25-2267 BASIC '05 For The Color Computer               | 59  |
| 25-2268 BASIC '05 For The Color Computer               | 59  |
| 25-2269 BASIC '05 For The Color Computer               | 59  |
| 25-2270 BASIC '05 For The Color Computer               | 59  |
| 25-2271 BASIC '05 For The Color Computer               | 59  |
| 25-2272 BASIC '05 For The Color Computer               | 59  |
| 25-2273 BASIC '05 For The Color Computer               | 59  |
| 25-2274 BASIC '05 For The Color Computer               | 59  |
| 25-2275 BASIC '05 For The Color Computer               | 59  |
| 25-2276 BASIC '05 For The Color Computer               | 59  |
| 25-2277 BASIC '05 For The Color Computer               | 59  |
| 25-2278 BASIC '05 For The Color Computer               | 59  |
| 25-2279 BASIC '05 For The Color Computer               | 59  |
| 25-2280 BASIC '05 For The Color Computer               | 59  |
| 25-2281 BASIC '05 For The Color Computer               | 59  |
| 25-2282 BASIC '05 For The Color Computer               | 59  |
| 25-2283 BASIC '05 For The Color Computer               | 59  |
| 25-2284 BASIC '05 For The Color Computer               | 59  |
| 25-2285 BASIC '05 For The Color Computer               | 59  |
| 25-2286 BASIC '05 For The Color Computer               | 59  |
| 25-2287 BASIC '05 For The Color Computer               | 59  |
| 25-2288 BASIC '05 For The Color Computer               | 59  |
| 25-2289 BASIC '05 For The Color Computer               | 59  |
| 25-2290 BASIC '05 For The Color Computer               | 59  |
| 25-2291 BASIC '05 For The Color Computer               | 59  |
| 25-2292 BASIC '05 For The Color Computer               | 59  |
| 25-2293 BASIC '05 For The Color Computer               | 59  |
| 25-2294 BASIC '05 For The Color Computer               | 59  |
| 25-2295 BASIC '05 For The Color Computer               | 59  |
| 25-2296 BASIC '05 For The Color Computer               | 59  |
| 25-2297 BASIC '05 For The Color Computer               | 59  |
| 25-2298 BASIC '05 For The Color Computer               | 59  |
| 25-2299 BASIC '05 For The Color Computer               | 59  |
| 25-2300 BASIC '05 For The Color Computer               | 59  |
| 25-2301 BASIC '05 For The Color Computer               | 59  |
| 25-2302 BASIC '05 For The Color Computer               | 59  |
| 25-2303 BASIC '05 For The Color Computer               | 59  |
| 25-2304 BASIC '05 For The Color Computer               | 59  |
| 25-2305 BASIC '05 For The Color Computer               | 59  |
| 25-2306 BASIC '05 For The Color Computer               | 59  |
| 25-2307 BASIC '05 For The Color Computer               | 59  |
| 25-2308 BASIC '05 For The Color Computer               | 59  |
| 25-2309 BASIC '05 For The Color Computer               | 59  |
| 25-2310 BASIC '05 For The Color Computer               | 59  |
| 25-2311 BASIC '05 For The Color Computer               | 59  |
| 25-2312 BASIC '05 For The Color Computer               | 59  |
| 25-2313 BASIC '05 For The Color Computer               | 59  |
| 25-2314 BASIC '05 For The Color Computer               | 59  |
| 25-2315 BASIC '05 For The Color Computer               | 59  |
| 25-2316 BASIC '05 For The Color Computer               | 59  |
| 25-2317 BASIC '05 For The Color Computer               | 59  |
| 25-2318 BASIC '05 For The Color Computer               | 59  |
| 25-2319 BASIC '05 For The Color Computer               | 59  |
| 25-2320 BASIC '05 For The Color Computer               | 59  |
| 25-2321 BASIC '05 For The Color Computer               | 59  |
| 25-2322 BASIC '05 For The Color Computer               | 59  |
| 25-2323 BASIC '05 For The Color Computer               | 59  |
| 25-2324 BASIC '05 For The Color Computer               | 59  |
| 25-2325 BASIC '05 For The Color Computer               | 59  |
| 25-2326 BASIC '05 For The Color Computer               | 59  |
| 25-2327 BASIC '05 For The Color Computer               | 59  |
| 25-2328 BASIC '05 For The Color Computer               | 59  |
| 25-2329 BASIC '05 For The Color Computer               | 59  |
| 25-2330 BASIC '05 For The Color Computer               | 59  |
| 25-2331 BASIC '05 For The Color Computer               | 59  |
| 25-2332 BASIC '05 For The Color Computer               | 59  |
| 25-2333 BASIC '05 For The Color Computer               | 59  |
| 25-2334 BASIC '05 For The Color Computer               | 59  |
| 25-2335 BASIC '05 For The Color Computer               | 59  |
| 25-2336 BASIC '05 For The Color Computer               | 59  |
| 25-2337 BASIC '05 For The Color Computer               | 59  |
| 25-2338 BASIC '05 For The Color Computer               | 59  |
| 25-2339 BASIC '05 For The Color Computer               | 59  |
| 25-2340 BASIC '05 For The Color Computer               |     |



# Cash Crop: Bond Yield to Maturity

by L. H. Southmayd

**W**hile VisiCalc's built-in functions meet most of my needs, they don't handle common financial calculations like yield to maturity (YTM) or internal rate of return (IROR). These functions require solving nonlinear equations by iterative methods; that is, by trial and error. Lotus 1-2-3's @IRR function is only a partial solution: you still must guess a value to initiate the trial-and-error process.

My template, BondYTM, calculates yield to maturity for standard and zero-coupon bonds; this is the return on your investment, incorporating the interest paid and any capital gain or loss you realize when the bond matures or when you sell it.

The template uses functions available with VisiCalc and which are compatible with Lotus 1-2-3. Because BondYTM uses the secant method to solve the nonlinear equation, it's efficient and fast. Also, you don't have to supply estimated YTM's to start the calculation; the formula does that for you.

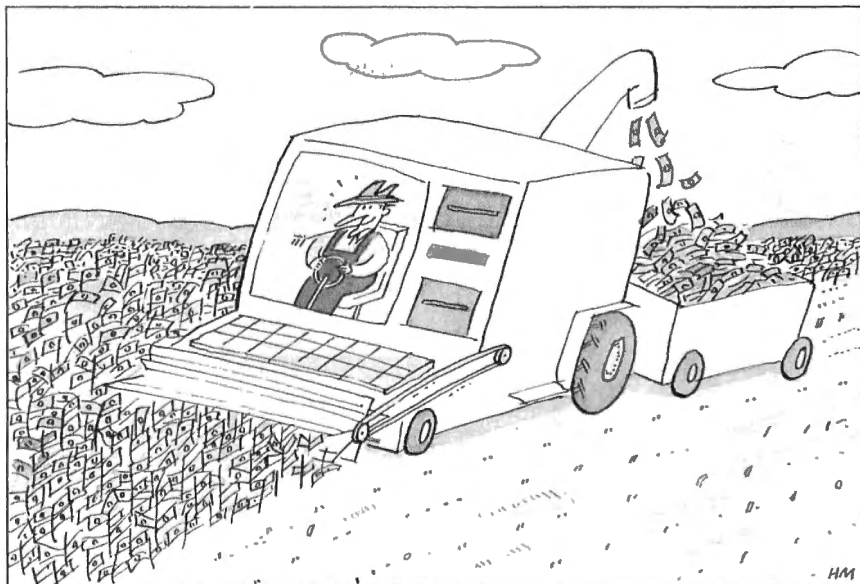

## Template Features

Figure 1 shows a sample calculation. Rows 7-13 and 16 of column C represent the input area, where you enter data about the bond you're evaluating. The settlement date is when payment for the bond is due; in the sample it is

Oct. 15, 1984. Note that you must enter the day, month, and year for settlement and maturity dates.

If you type in zero in the coupon (annual interest) area, the formula calculates both the conventional YTM, using semiannual compounding, and the true

|    | A                                           | B             | C           | D                    | E            | F            | G            | H            |
|----|---------------------------------------------|---------------|-------------|----------------------|--------------|--------------|--------------|--------------|
| 1  | L. H. Southmayd                             | BONDYTM/VC or | BONDYTM.WKS | 13 character columns |              |              |              |              |
| 2  | 27 Barclay Road                             |               | (LOTUS 123) | Row calculation      |              |              |              |              |
| 3  | Scarsdale, N. Y. 10583                      | 914 723 9054  |             |                      |              |              |              |              |
| 4  |                                             |               |             |                      |              |              |              |              |
| 5  |                                             |               |             |                      |              |              |              |              |
| 6  |                                             |               |             |                      |              |              |              |              |
| 7  | Settlement Date                             | MM.DD         | 10.15       |                      |              |              |              |              |
| 8  |                                             | Year          | 1984        |                      |              |              |              |              |
| 9  | Maturity Date *                             | MM.DD         | 7.01        |                      |              |              |              |              |
| 10 |                                             | Year          | 1997        |                      | Days         |              | Full 1/2 Yrs | Frac 1/2 Yrs |
| 11 | Principal Amount *                          |               | 1000.00     |                      | 4642         |              | 25           | .4356164383  |
| 12 | Coupon (annual interest)                    |               | 98.00       |                      |              | Set f(YTM)=0 |              | 49           |
| 13 | Price (for \$1000 bond)                     |               | 990.00      |                      | Initial Est  | f(est YTM)=  | 1017.65      | Secant Est   |
| 14 | Plus accrued interest                       |               | 27.65       |                      | .09928271257 | .55570193    | .55570193    | .09928271257 |
| 15 | Total per bond                              |               | 1017.65     |                      | .09977912613 | -2.95566911  | 2.95566911   | .0993612739  |
| 16 | Number of bonds                             |               | 10          |                      |              | -.00118244   | .00118244    | .09936130534 |
| 17 | Total                                       |               | 10176.50    |                      |              | -.00140525   | .00140525    | .09936110705 |
| 18 |                                             |               |             |                      |              | -.00000007   | .00000007    | .09936110704 |
| 19 |                                             |               |             |                      |              | -.00000001   | .00000001    | .09936110704 |
| 20 |                                             |               |             |                      |              | -.00000001   | .00000001    | .09936110704 |
| 21 |                                             |               |             |                      |              | -.00067811   | .00067811    | .09936110704 |
| 22 |                                             |               |             |                      |              | -.00000001   | .00000001    | .09936110704 |
| 23 |                                             |               |             |                      |              | -.00000001   | .00000001    | .09936110704 |
| 24 |                                             |               |             |                      |              |              |              |              |
| 25 | Bond Yield to Maturity #                    |               | 9.94 %      |                      |              |              |              |              |
| 26 | Calculated Price Check                      |               | 990.00      |                      |              |              |              |              |
| 27 |                                             |               |             |                      |              |              |              |              |
| 28 | # Conventional YTM (semiannual compounding) |               |             |                      |              |              |              |              |
| 29 | If Zero Coupon, True YTM=                   |               | NA %        |                      |              |              |              |              |

Figure 1. BondYTM template.



Prices & Specifications subject to change without notice

IBM is a trademark of International Business Machines Corporation  
TRS-80 is a trademark of the Tandy Corporation

OR WRITE: DISPLAYED VIDEO 111 MARSHALL ST., LITCHFIELD, MI 49252  
(517) 542-3939 (517) 542-3947

Free Shipping in the U.S.  
48 Contiguous States

IMMEDIATE DELIVERY  
180 Days Parts and Labor Warranty  
DEALER INQUIRIES INVITED

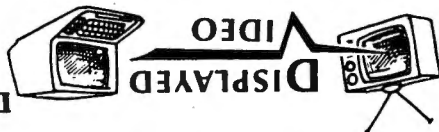

WE CARRY TANDY, RADIO SHACK, SANYO & IBM

OR 886 ECORSE RD. YPSILANTI, MI 48197  
(517) 542-3939 TECHNICAL SUPPORT

111 Marshall Street  
Litchfield, MI 49252  
(517) 542-3280  
(517) 542-3939  
(517) 542-3947

OR  
(313) 426-5086 / (313) 482-4424

886 Ecorse Road  
Ypsilanti, MI 48197

Visit our two retail locations at:

### COMPUTERS

|                                                     |          |                                                                                  |          |
|-----------------------------------------------------|----------|----------------------------------------------------------------------------------|----------|
| TANDY 1000 W/2 drives . . . . .                     | \$1,199. | IBM W/2 double sided drives, 256K . . . . .                                      | \$1,849. |
| TANDY 1000 W/2 drives & RGB color monitor . . . . . | \$1,549. | IBM W/1 double sided disk drive, one 10 meg. hard disk, 256 K . . . . .          | \$2,695. |
| MODEL 4 W/2 drives (26 1069) . . . . .              | \$985.   | Monochrome monitor or color monitor display card for IBM or Tandy 1200 . . . . . | \$225.   |
| MODEL 4P W/2 disk drives . . . . .                  | \$825.   | High resolution RGB Teknika color monitor . . . . .                              | \$325.   |
| MODEL 4P W/2 double sided drives . . . . .          | \$1,049. |                                                                                  |          |
| TANDY 1200 . . . . .                                | \$1,749. |                                                                                  |          |

### DISK DRIVES

#### TEAC HALF HEIGHT DISK DRIVES

|                                         |        |                                             |        |
|-----------------------------------------|--------|---------------------------------------------|--------|
| FD55a 40 trk ssdd bare . . . . .        | \$125. | FD55a 40 trk w/case & power . . . . .       | \$165. |
| FD55b 40/40 trk dsdd bare . . . . .     | \$135. | FD55b 40/40 trk w/case & power . . . . .    | \$175. |
| FD55f 80/80 trk dsdd bare . . . . .     | \$160. | FD55f 80/80 trk w/case & power . . . . .    | \$199. |
| Tandon 40 trk bare . . . . .            | \$125. | Fullsize case & power supply . . . . .      | \$45.  |
| Tandon 40/40 trk bare . . . . .         | \$160. | Slimline case & power supply . . . . .      | \$45.  |
| 8" dual slimline case & power . . . . . | \$149. | Dual slimline case & power supply . . . . . | \$55.  |

### PRINTERS

| EPSON                                                  |          | STAR           |        | JUKI                              |        |
|--------------------------------------------------------|----------|----------------|--------|-----------------------------------|--------|
| LX80 . . . . .                                         | \$375.   | SG10 . . . . . | \$259. | 6100 Daisywheel . . . . .         | \$425. |
| FX80+ . . . . .                                        | \$395.   | SG15 . . . . . | \$379. | (parallel)                        |        |
| FX100+ . . . . .                                       | \$575.   | SD10 . . . . . | \$375. | 6100 Daisywheel . . . . .         | \$475. |
| RX100 . . . . .                                        | \$415.   | SD15 . . . . . | \$475. | (serial)                          |        |
| LQ1500 & interface . . . . .                           | \$1,125. | SR10 . . . . . | \$560. | 6300 Daisywheel . . . . .         | \$725. |
| JX80 . . . . .                                         | \$595.   | SR15 . . . . . | \$640. | 6000 Diasywheel . . . . .         | \$220. |
| We stock all Radio Shack printers . . . . .            |          |                |        | Call for price                    |        |
| Radio Shack, IBM, TI, & Sanyo printer cables . . . . . |          |                |        | \$24.99                           |        |
| Printer paper 20# 2700 sheets . . . . .                |          |                |        | \$29.00                           |        |
| Epson 80 series ribbon . . . . .                       |          | \$8.00         |        | Epson 100 series ribbon . . . . . |        |
|                                                        |          |                |        | \$10.00                           |        |

### PERIPHERALS

| MODEMS                                                            |        | MONITORS                                 |          |
|-------------------------------------------------------------------|--------|------------------------------------------|----------|
| ANCHOR MARK XII<br>300/1200 baud (Hayes compatible) . . . . .     | \$259. | Teknika hi-res. color monitor . . . . .  | \$325.!! |
| ANCHOR MARK X<br>300/1200 baud (Hayes compatible) . . . . .       | \$125. | Comrex green or amber monitor . . . . .  | \$115.   |
| Volksmodem 12 & cable<br>300/1200 baud auto /ans au /dl . . . . . | \$220. | Zenith green or amber monitor . . . . .  | \$120.   |
| Hayes 300 baud . . . . .                                          | \$205. | <b>MISCELLANEOUS</b>                     |          |
| Hayes 1200 baud . . . . .                                         | \$430. | Model III/4RS 232 board . . . . .        | \$75.    |
| Volks modems & cable . . . . .                                    | \$69.  | Model I double density board . . . . .   | \$85.    |
|                                                                   |        | 64k 150ns memory chips . . . . .         | \$2.95   |
|                                                                   |        | Power strip w/surge protection . . . . . | \$25.    |
|                                                                   |        | Bulk diskettes pack of 10 . . . . .      | \$13.    |
|                                                                   |        | Verbatim diskette pack of 10 . . . . .   | \$20.    |

**★ DISPLAYED VIDEO ★**  
**IS TURNING THE COMPUTER WORLD**  
**UPSIDE DOWN!!**



YTM. I provided this feature because I've found that some zero bond salespeople and ads don't always identify which kind of YTM they're quoting.

After you enter the coupon, price and number of bonds, type in an exclamation point to invoke the Calculate command. In 33 seconds (on a Model III), you'll see the YTM displayed on line 25.

BondYTM also calculates the accrued interest, the adjustment you must make for interest earned since the last interest payment before you bought or sold the bond.

The calculated price check tests the template's accuracy. The calculated YTM, entered automatically in the equation, should give you the bond's price.

Note that when you load the template, VisiCalc displays an error message, then recalculates. When the recalculation is complete, BondYTM is ready to use.

## It Figures

The template's calculation area covers columns E-H. The calculation area has two parts: Cell E11 finds the number of days between the settlement and maturity dates, while the rest of the calculation area solves the nonlinear equation using the well-known secant method. Figure 2 shows BondYTM's formula listing.

BondYTM precalculates some variables, such as the number of full half-years and fractional half-years, in order to save computation time per step.

Column E contains the two initial estimates the secant method requires to solve the equation. The first is based on a familiar approximation of YTM. The formula sets the second estimate either ½ percent above or ½ percent below the first, depending on whether the bond's price is below or above par.

I avoid potential divide-by-zero problems by stopping the new iterations when the new estimate equals the old estimate, which is a function of the computer's accuracy. The capacity for nine iterations plus the initial guess provides ample accuracy.

This cell also contains a test for zero-coupon bonds and bonds bought at par. In these two special cases, BondYTM calculates YTM directly and quickly, bypassing all four columns and filling them with @NAs.

The calculations in column F and in cell C26 use the formula for the price of a bond on any date, not necessarily the coupon date. By industry convention, you approximate accrued interest by multiplying half the annual coupon by 1 minus the fractional half-year to the date of the next coupon payment.

The equation in column F is in the form  $f(x)=0$  where all the variables are known except the estimated YTM, cal-

```
>E11: (@INT(365.25*C10)+@INT(30.6*@INT(C9))+(C9-@INT(C9)*100))-(@INT(36
5.25*C8)+@INT(30.6*@INT(C7))+(C7-@INT(C7)*100))
>G11: @INT(E11*2/365)
>H11: @IF((E11*2/365-G11)<.02,0,(E11*2/365-G11))
>H12: +C12/2
>G13: /F$+C13+(H12*(1-H11))
>C14: @INT(H12*(1-H11)*100+.5)/100
>E14: @IF(C12=0,@NA,@IF(C13=1000,@NA,C12+(C11-C13*365/E11)/((C13+C11)/2
))
>F14: -G13+((C12/E14*(1-((1+(E14/2))^G11)))+(C11/((1+(E14/2))^G11)+H12)
/((1+(E14/2))^H11))
>G14: @ABS(F14)
>H14: +E14
>C15: +C13+C14
>E15: @IF(C13<C11,E14*1.005,E14*.995)
>F15: -G13+((C12/E15*(1-((1+(E15/2))^G11)))+(C11/((1+(E15/2))^G11)+H12)
/((1+(E15/2))^H11))
>G15: @ABS(F15)
>H15: @IF(E15=0,E15-(F15*(E15-E14)/(F15-F14))
>F16: -G13+((C12/H15*(1-((1+(H15/2))^G11)))+(C11/((1+(H15/2))^G11)+H12)
/((1+(H15/2))^H11))
>G16: @ABS(F16)
>H16: @IF(F16=F15,H15,H15-(F16*(H15-H14)/(F16-F15))
>C17: /F$+C15*C16
>F17: -G13+((C12/H16*(1-((1+(H16/2))^G11)))+(C11/((1+(H16/2))^G11)+H12)
/((1+(H16/2))^H11))
>G17: @ABS(F17)
>H17: @IF(F17=F16,H16,H16-(F17*(H16-H15)/(F17-F16))
>F18: -G13+((C12/H17*(1-((1+(H17/2))^G11)))+(C11/((1+(H17/2))^G11)+H12)
/((1+(H17/2))^H11))
>G18: @ABS(F18)
>H18: @IF(F18=F17,H17,H17-(F18*(H17-H16)/(F18-F17))
>F19: -G13+((C12/H18*(1-((1+(H18/2))^G11)))+(C11/((1+(H18/2))^G11)+H12)
/((1+(H18/2))^H11))
>G19: @ABS(F19)
>H19: @IF(F19=F18,H18,H18-(F19*(H18-H17)/(F19-F18))
>F20: -G13+((C12/H19*(1-((1+(H19/2))^G11)))+(C11/((1+(H19/2))^G11)+H12)
/((1+(H19/2))^H11))
>G20: @ABS(F20)
>H20: @IF(F20=F19,H19,H19-(F20*(H19-H18)/(F20-F19))
>F21: -G13+((C12/H20*(1-((1+(H16/2))^G11)))+(C11/((1+(H20/2))^G11)+H12)
/((1+(H20/2))^H11))
>G21: @ABS(F21)
>H21: @IF(F21=F20,H20,H20-(F21*(H20-H19)/(F21-F20))
>F22: -G13+((C12/H21*(1-((1+(H21/2))^G11)))+(C11/((1+(H21/2))^G11)+H12)
/((1+(H21/2))^H11))
>G22: @ABS(F22)
>H22: @IF(F22=F21,H21,H21-(F22*(H21-H20)/(F22-F21))
>F23: -G13+((C12/H22*(1-((1+(H22/2))^G11)))+(C11/((1+(H22/2))^G11)+H12)
/((1+(H22/2))^H11))
>G23: @ABS(F23)
>H23: @IF(F23=F22,H22,H22-(F23*(H22-H21)/(F23-F22))
>G24: @MIN(G14...G23)
>H24: @IF(G23=G24,H23,@IF(G22=G24,H22,@IF(G21=G24,H21,@IF(G20=G24,H20,@
IF(G19=G24,H19,@IF(G18=G24,H18,@IF(G17=G24,H17,H16)
>C25: /F$@IF(C12=0,((C11/C13)^(365/(2*E11))-1)*200,@IF(C13=C11,C12/10,1
00*H24))
>C26: /F$@IF(C13=C11,C13,((C12/(C25/100)*(1-((1+(C25/200))^G11)))+(C11/
((1+(C25/200))^G11)+H12)/((1+(C25/200))^H11))-(H12*(1-H11))
>C29: /F$@IF(C12=0,((C11/C13)^(365/E11))-1)*100,@NA)
```

Figure 2. BondYTM's formula listing.

culated by the secant method in the prior step and taken from column H. The estimated YTM becomes more accurate as  $f(x)$  approaches zero within VisiCalc's significant digits.

Column G is the absolute of column F. This part of the algorithm selects the most accurate estimated YTM in column H; that is, the estimated YTM with the lowest absolute value in column F. The @MIN function in cell G24 determines column F's lowest absolute value.

Cell H24 contains a series of chained @IF functions that determine which value in column H matches the lowest absolute value of  $f(x)=0$  in column F. I used this particular select method to make the cell easily translatable by Lotus 1-2-3. ■

L.H. Southmayd uses his Model III for investment and tax planning. You can write to him at 27 Barclay Road, Scarsdale, NY 10583.

The template's days-between-dates algorithm is used with the permission of Spreadsheet newsletter, Stamford, CT.

Submit your template to Spreadsheet Beat, 80 Micro, 80 Pine St., Peterborough, NH 03458. We'll pay \$50 for each one we publish.



## System Requirements

VisiCalc or Lotus 1-2-3



# DAISY WHEEL

## New Smith Corona L-1000

True letter quality printer for less than the cost of an office typewriter! Priced \$500 less than other popular daisy wheel printers!

SALE PRICE:  
**\$249**

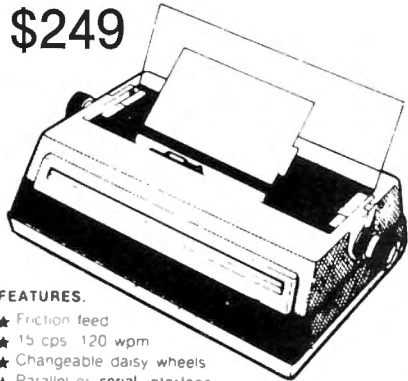

**FEATURES.**

- ★ Friction feed
- ★ 15 cps 120 wpm
- ★ Changeable daisy wheels
- ★ Parallel or serial interface
- ★ Compatible with R S Apple etc



**SUNLOCK SYSTEMS**  
210 Conner Rd.  
Mechanicsville, VA 23111  
(804)-746-1600

**ADDITIONAL PRINTER SPECIALS**

|           |         |             |       |             |       |
|-----------|---------|-------------|-------|-------------|-------|
| Epson     | Okidata | ComrexCR11  | \$359 | Citoh 7500  | \$239 |
| RX80      | ML92    | Comrex III  | 599   | Citoh F10   | 899   |
| LX80      | ML192   | Star SG10   | 239   | Citoh 1550  | 449   |
| RX100     | ML84    | Star PwrTp. | 329   | Citoh 8510  | 319   |
| FX80+     | Ok120   | Str.Radxl0  | 519   | Sv.Reed 550 | 449   |
| FX100+499 | ML93    | Gemini 15x  | 349   | Sv.Reed 500 | 379   |
| JX 80 499 | ML182   | Delta 10    | 359   | Epson 1500  | 899   |

**TO ORDER CALL TOLL FREE 800-368-9191**  
In Virginia call 804-321-9191  
We accept MasterCard, Visa and CODs

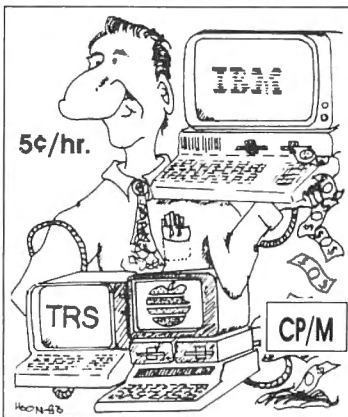

## FILE TRANSFER

### + Conversion Utilities

**Transfers: (no more retyping)**

- Visicalc, Multiplan
- Data Files, ASCII Files
- Word Processing Files
- Basic, Fortran, Cobol



MC/VISA/COD/CHECK OK



### TRANSFER SERVICE: Call for Information

Free with any order this Month Omegbug or Diskette Pens

|       |        |                        |        |
|-------|--------|------------------------|--------|
| TRS   | } To { | IBM PC/XT              | 149.95 |
| Apple |        | Tandy 1000, 1200, 2000 | 149.95 |
| CP/M  |        | IBM AT                 | 224.95 |



IBM PC (To/From) Tandy 2000 Disk Transporter 129.95

|                                  |         |
|----------------------------------|---------|
| Drives 360 KB                    | 265.00  |
| CMI 40 Meg.                      | 1150.00 |
| 128K Ram Set                     | 145.00  |
| Prototype Board & Extender Cards | 120/ea. |
| High Capacity Disks              | \$40/10 |

**PERSONAL COMPUTER PRODUCTS**

3080 Olcott Dr. Ste. 130B, Santa Clara, CA 95051 (408) 988-0164

## NEW PRINTERS ADDED! FIND YOURS BELOW.

# RIBBON SALE

## EXACT REPLACEMENTS

| PRINTER<br>MAKE, MODEL NUMBER<br>Contact us if your printer is<br>not listed. We have many more in stock.<br>We can probably RELOAD your old cartridges | RIBBON<br>SIZE<br>Inches<br>by<br>Yards  | NEW CARTRIDGES<br>From the various<br>manufacturers or made<br>in our own shop<br>Ready to use | RELOADS<br>You SEND your used<br>CARTRIDGES to us. WE<br>put OUR NEW INSERTS<br>in them | INSERTS EZ-LOAD™<br>DROP IN. NO WINDING!<br>EXACT REPLACEMENTS<br>made in our own shop.<br>Cartridges NOT included. |
|---------------------------------------------------------------------------------------------------------------------------------------------------------|------------------------------------------|------------------------------------------------------------------------------------------------|-----------------------------------------------------------------------------------------|---------------------------------------------------------------------------------------------------------------------|
| BASE 2, DIP 81-82-84-85, MPI 88-99-GX                                                                                                                   | 1/2 x 20                                 | \$20/2 \$57/6 \$108/12                                                                         | \$7/1 \$6 ea 2 or more                                                                  | \$15/3 \$54/12 \$288/72                                                                                             |
| CITOH Prowriter 1550-8510, NEC 8023-8025, APPLE DMP-IMAGEW                                                                                              | 1/2 x 18                                 | \$15/2 \$42/6 \$ 78/12                                                                         | \$7/1 \$6 ea 2 or more                                                                  | \$15/3 \$54/12 \$288/72                                                                                             |
| CITOH STARWRITER F-10-40 }<br>DIABLO HYTYPE II }                                                                                                        | Carbon Film Black                        | 5/16 x 130                                                                                     | \$18/3 \$60/12 \$342/72                                                                 | \$5 ea 3-11 \$4 ea 12 or more \$24/6 \$42/12 \$234/72                                                               |
|                                                                                                                                                         | Fabric Black                             | NOT EZ-LOAD<br>5/16 x 17                                                                       | \$18/2 \$51/6 \$ 96/12                                                                  | \$8/1 \$7 ea 2 or more \$7 ea 2 or more \$21/3 \$78/12 \$432/72                                                     |
| RADIO SHACK-TOSHIBA-COMMODORE-PANASONIC-RICOH                                                                                                           |                                          |                                                                                                |                                                                                         |                                                                                                                     |
| Carbon Film - DWP 210 (Hytype II)                                                                                                                       | Black (1445)                             | 5/16 x 145                                                                                     | \$18/3 \$60/12 \$342/72                                                                 | \$5 ea 3-11 \$4 ea 12 or more \$24/6 \$42/12 \$234/72                                                               |
| DW II, DWP 410-510, RICOH 1200-1300-1600                                                                                                                | Black (1419)                             | 1/4 x 145                                                                                      | \$18/3 \$60/12 \$342/72                                                                 | \$5 ea 3-11 \$4 ea 12 or more \$24/6 \$42/12 \$234/72                                                               |
| Red, Green, Blue, Brown                                                                                                                                 | Colors (1419)                            | 1/4 x 130                                                                                      | \$21/3 \$72/12 \$420/72                                                                 | \$6 ea 3-11 \$5 ea 12 or more \$30/6 \$54/12 \$234/72                                                               |
| Fabric (Long Life), DWP 210 (Hytype II)                                                                                                                 | Black (1458)                             | 5/16 x 17                                                                                      | \$18/2 \$51/6 \$ 96/12                                                                  | \$8/1 \$7 ea 2 or more \$21/3 \$78/12 \$432/72                                                                      |
| DW II, DWP 410-510, RICOH 1200-1300-1600                                                                                                                | Black (1449)                             | NOT EZ-LOAD<br>1/4 x 25                                                                        | \$18/2 \$51/6 \$ 96/12                                                                  | \$8/1 \$7 ea 2 or more \$21/3 \$78/12 \$432/72                                                                      |
| DMP-100, LP VII, COMMODORE 1525, GORILLA BANANA (1424)                                                                                                  | (1296) (1483)                            | Inker Loop                                                                                     | \$18/2 \$51/6 \$ 96/12                                                                  |                                                                                                                     |
| DMP-200, 120, (430 Inserts & Reloads Only)                                                                                                              | (1418)                                   | 1/2 x 20                                                                                       | \$20/2 \$57/6 \$108/12                                                                  | \$7/1 \$7 ea 2 or more \$15/3 \$54/12 \$288/72                                                                      |
| DMP-400-420, LP VI-VIII, PANASONIC KXP-130                                                                                                              | (1482)                                   | 5/16 x 14                                                                                      | \$15/2 \$42/6 \$ 78/12                                                                  | \$7/1 \$6 ea 2 or more \$15/3 \$54/12 \$288/72                                                                      |
| DMP-500                                                                                                                                                 | (1482)                                   | 1/2 x 20                                                                                       | \$22/2 \$63/6 \$120/12                                                                  | \$7/1 \$6 ea 2 or more \$15/3 \$54/12 \$288/72                                                                      |
| DMP-2100, TOSHIBA P1340-1350-1351                                                                                                                       | (1442)                                   | 1/2 x 20                                                                                       | \$15/2 \$42/6 \$ 78/12                                                                  | \$7/1 \$6 ea 2 or more \$15/3 \$54/12 \$288/72                                                                      |
| LP-I-II-IV, CENTRONICS 730-737-739-779 (Zip Pack)                                                                                                       | (1413)                                   | 9/16 x 16                                                                                      |                                                                                         | \$12/3 \$45/12 \$252/72                                                                                             |
| LP III-V                                                                                                                                                | (1414)                                   | 1/2 x 15                                                                                       | \$15/2 \$42/6 \$ 78/12                                                                  | \$7/1 \$6 ea 2 or more \$15/3 \$54/12 \$288/72                                                                      |
| EPSON LQ 1500                                                                                                                                           |                                          |                                                                                                |                                                                                         |                                                                                                                     |
| MX-FX-RX 70-80, IBM PC (Standard Paper)                                                                                                                 | 1/2 x 14                                 | \$22/2 \$63/6 \$120/12                                                                         | \$7/1 \$6 ea 2 or more                                                                  | \$15/3 \$54/12 \$288/72                                                                                             |
| MX-FX-RX 100, IBM PC (Wide Paper)                                                                                                                       | 1/2 x 20                                 | \$14/2 \$36/6 \$ 66/12                                                                         | \$7/1 \$6 ea 2 or more                                                                  | \$15/3 \$54/12 \$288/72                                                                                             |
|                                                                                                                                                         | 1/2 x 30                                 | \$18/2 \$51/6 \$ 96/12                                                                         | \$8/1 \$7 ea 2 or more                                                                  | \$18/3 \$66/12 \$360/72                                                                                             |
| COMMODORE 8023P, CENTRONICS 152-2                                                                                                                       | 1/2 x 12                                 | \$14/2 \$36/6 \$ 66/12                                                                         | \$7/1 \$6 ea 2 or more                                                                  | \$15/3 \$54/12 \$288/72                                                                                             |
| ANADEX 9000 Series                                                                                                                                      | 1/2 x 30                                 | \$18/2 \$51/6 \$ 96/12                                                                         | \$8/1 \$7 ea 2 or more                                                                  | \$18/3 \$66/12 \$360/72                                                                                             |
| NEC Spinwriter-Carbon Film-2000-3500 (Reloads BCCOMPCO Only)                                                                                            | 5/16 x 145                               | \$21/3 \$78/12 \$450/72                                                                        | \$5 ea 3-11 \$4 ea 12 or more                                                           | \$24/6 \$42/12 \$234/72                                                                                             |
| -Fabric -5500-7700 (Can Reload Most Types)                                                                                                              | 1/4 x 145                                | \$18/3 \$60/12 \$342/72                                                                        | \$5 ea 3-11 \$4 ea 12 or more                                                           | \$24/6 \$42/12 \$234/72                                                                                             |
| -2000-3500 (Can Reload All)                                                                                                                             | 1/2 x 14                                 | \$18/2 \$51/6 \$ 96/12                                                                         | \$8/1 \$7 ea 2 or more                                                                  | \$15/3 \$54/12 \$288/72                                                                                             |
| -5500-7700 (Can Reload All)                                                                                                                             | 1/2 x 13                                 | \$15/2 \$42/6 \$ 78/12                                                                         | \$8/1 \$7 ea 2 or more                                                                  | \$15/3 \$54/12 \$288/72                                                                                             |
| OKIDATA Pacemark 2350-2410 Black                                                                                                                        | 1/2 x 100                                | \$32 each                                                                                      | \$20/1 \$18 ea 2 or more                                                                | 36/3 \$132/12 \$720/72                                                                                              |
| Microline ML-80-82-83-92-93 (Call for ML-84 Prices)                                                                                                     | 1/2 x 16                                 | Spool \$39/12 \$216/72                                                                         |                                                                                         |                                                                                                                     |
| MANNESMAN-TALLY MT-160                                                                                                                                  | 9mm x 11                                 | \$19/2 \$54/6 \$102/12                                                                         |                                                                                         |                                                                                                                     |
| MT-180                                                                                                                                                  | 9mm x 13                                 | \$20/2 \$57/6 \$108/12                                                                         |                                                                                         |                                                                                                                     |
| -Spirit 80 (SP80) COMMODORE 1526 (Multistrike)                                                                                                          | 1/2 x 35                                 | \$16/2 \$45/6 \$ 84/12                                                                         |                                                                                         |                                                                                                                     |
| PANASONIC KXP-1090-1091-1092-1093                                                                                                                       | 5/16 x 3                                 | \$20/2 \$57/6 \$108/12                                                                         |                                                                                         |                                                                                                                     |
| BROTHER HR-15-25-35 }<br>COMREX DX-15, II }                                                                                                             | Carbon Film (Multistrike or Correctable) | 5/16 x 82                                                                                      | \$18/3 \$60/12 \$342/72                                                                 |                                                                                                                     |
|                                                                                                                                                         | Fabric (Call for Comrex 420 Prices)      | 5/16 x 17                                                                                      | \$15/2 \$42/12 \$ 78/72                                                                 |                                                                                                                     |

SEND CHECK, MONEY ORDER, OR C.O.D. TO.

**BCCOMPCO**  
800 South 17 Box 246  
SUMMERSVILLE, MO 65571  
(417) 932-4196

WE PAY UPS SHIPPING ON PREPAID ORDERS  
PLEASE INCLUDE STREET ADDRESS for UPS DELIVERY  
FOREIGN ADD 15% U.S. FUNDS







# READER SERVICE

This card valid until September 30, 1985.

A. How would you describe your interest in MS/dos, IBM Compatible Systems?

1. I own an MS/dos, IBM compatible system.  
 2. I intend to purchase.  
 3. I'm interested but have no immediate plans to purchase.  
 4. Not interested.

B. On a scale of 1 (no interest) to 5 (great interest), please rate your interest in seeing the following types of programs published in 80 Micro:

- \_\_\_ 1. Business applications \_\_\_ 4. Money management applications  
 \_\_\_ 2. Science/math applications \_\_\_ 5. Games  
 \_\_\_ 3. Home management applications \_\_\_ 6. Programming utilities

C. How many people read your copy of 80 Micro?

1. One  4. Four  
 2. Two  5. Five or more  
 3. Three

D. What type of TRS-80 do you own? Check all that apply.

1. Model I  7. Model 1000  
 2. Model III/12  8. Model 1200  
 3. Model III  9. Model 2000  
 4. Model 4/4P  10. Pocket Computer  
 5. Model 16/16B/6000  11. Color Computer  
 6. Model 100/200

E. How long have you owned your TRS-80?

1. Less than 1 year  4. 3-4 years  
 2. 1-2 years  5. More than 4 years  
 3. 2-3 years

F. Was it a gift?

1. Yes  2. No

G. Do you plan to purchase another TRS-80 during the next 12 months?

1. Yes  2. No  3. Don't know

H. Where do you use your TRS-80? Check all that apply.

1. At home  
 2. At work  
 3. At school

I. How many children use your TRS-80 for educational purposes?

1. Zero  3. Two  
 2. One  4. Three or more

J. Do you plan to make a purchase based on an ad you saw in this issue of 80 Micro?

1. Yes  2. No  3. Don't know

L. Which of the following columns do you read? Please rate them on a scale of 1 (seldom read) to 5 (always read):

- \_\_\_ 1. Side Tracks \_\_\_ 7. The Spreadsheet Beat  
 \_\_\_ 2. Feedback Loop \_\_\_ 8. Input  
 \_\_\_ 3. Pulse Train \_\_\_ 9. Reader Exchange  
 \_\_\_ 4. Basic Takes \_\_\_ 10. Reviews  
 \_\_\_ 5. The Next Step \_\_\_ 11. New Products  
 \_\_\_ 6. Ask Tandy

M. If you are not a subscriber, please circle 500.

N. If you would like a one year subscription to 80 MICRO, please circle 501 on the Reader Service Card. Each subscription costs \$24.97. (Canada & Mexico \$27.97, Foreign Surface \$44.97, one year only). Please allow 10-12 weeks for delivery.

**Reader Service:** To receive more information from any of the advertisers in this issue, circle the number of the Reader Service Card that corresponds with the Reader Service number on the ad in which you are interested. You will find numbers. Complete the entire card, stamp and drop into a mailbox. In 4-6 weeks you will hear from the advertiser directly.

|                     |                     |                     |                     |
|---------------------|---------------------|---------------------|---------------------|
| 1 6 11 16 21        | 151 156 161 166 171 | 301 306 311 316 321 | 451 456 461 466 471 |
| 2 7 12 17 22        | 152 157 162 167 172 | 302 307 312 317 322 | 452 457 462 467 472 |
| 3 8 13 18 23        | 153 158 163 168 173 | 303 308 313 318 323 | 453 458 463 468 473 |
| 4 9 14 19 24        | 154 159 164 169 174 | 304 309 314 319 324 | 454 459 464 469 474 |
| 5 10 15 20 25       | 155 160 165 170 175 | 305 310 315 320 325 | 455 460 465 470 475 |
| 26 31 36 41 46      | 176 181 186 191 196 | 326 331 336 341 346 | 476 481 486 491 496 |
| 27 32 37 42 47      | 177 182 187 192 197 | 327 332 337 342 347 | 477 482 487 492 497 |
| 28 33 38 43 48      | 178 183 188 193 198 | 328 333 338 343 348 | 478 483 488 493 498 |
| 29 34 39 44 49      | 179 184 189 194 199 | 329 334 339 344 349 | 479 484 489 494 499 |
| 30 35 40 45 50      | 180 185 190 195 200 | 330 335 340 345 350 | 480 485 490 495 500 |
| 51 56 61 66 71      | 201 206 211 216 221 | 351 356 361 366 371 | 501 506 511 516 521 |
| 52 57 62 67 72      | 202 207 212 217 222 | 352 357 362 367 372 | 502 507 512 517 522 |
| 53 58 63 68 73      | 203 208 213 218 223 | 353 358 363 368 373 | 503 508 513 518 523 |
| 54 59 64 69 74      | 204 209 214 219 224 | 354 359 364 369 374 | 504 509 514 519 524 |
| 55 60 65 70 75      | 205 210 215 220 225 | 355 360 365 370 375 | 505 510 515 520 525 |
| 76 81 86 91 96      | 226 231 236 241 246 | 376 381 386 391 396 | 526 531 536 541 546 |
| 77 82 87 92 97      | 227 232 237 242 247 | 377 382 387 392 397 | 527 532 537 542 547 |
| 78 83 88 93 98      | 228 233 238 243 248 | 378 383 388 393 398 | 528 533 538 543 548 |
| 79 84 89 94 99      | 229 234 239 244 249 | 379 384 389 394 399 | 529 534 539 544 549 |
| 80 85 90 95 100     | 230 235 240 245 250 | 380 385 390 395 400 | 530 535 540 545 550 |
| 101 106 111 116 121 | 251 256 261 266 271 | 401 406 411 416 421 | 551 556 561 566 571 |
| 102 107 112 117 122 | 252 257 262 267 272 | 402 407 412 417 422 | 552 557 562 567 572 |
| 103 108 113 118 123 | 253 258 263 268 273 | 403 408 413 418 423 | 553 558 563 568 573 |
| 104 109 114 119 124 | 254 259 264 269 274 | 404 409 414 419 424 | 554 559 564 569 574 |
| 105 110 115 120 125 | 255 260 265 270 275 | 405 410 415 420 425 | 555 560 565 570 575 |
| 126 131 136 141 146 | 276 281 286 291 296 | 426 431 436 441 446 | 576 581 586 591 596 |
| 127 132 137 142 147 | 277 282 287 292 297 | 427 432 437 442 447 | 577 582 587 592 597 |
| 128 133 138 143 148 | 278 283 288 293 298 | 428 433 438 443 448 | 578 583 588 593 598 |
| 129 134 139 144 149 | 279 284 289 294 299 | 429 434 439 444 449 | 579 584 589 594 599 |
| 130 135 140 145 150 | 280 285 290 295 300 | 430 435 440 445 450 | 580 585 590 595 600 |

Name \_\_\_\_\_ Title \_\_\_\_\_

Address \_\_\_\_\_

City \_\_\_\_\_ State \_\_\_\_\_ Zip \_\_\_\_\_

Telephone ( ) \_\_\_\_\_

**80micro** • August 1985

# READER SERVICE

This card valid until September 30, 1985.

A. How would you describe your interest in MS/dos, IBM Compatible Systems?

1. I own an MS/dos, IBM compatible system.  
 2. I intend to purchase.  
 3. I'm interested but have no immediate plans to purchase.  
 4. Not interested.

B. On a scale of 1 (no interest) to 5 (great interest), please rate your interest in seeing the following types of programs published in 80 Micro:

- \_\_\_ 1. Business applications \_\_\_ 4. Money management applications  
 \_\_\_ 2. Science/math applications \_\_\_ 5. Games  
 \_\_\_ 3. Home management applications \_\_\_ 6. Programming utilities

C. How many people read your copy of 80 Micro?

1. One  4. Four  
 2. Two  5. Five or more  
 3. Three

D. What type of TRS-80 do you own? Check all that apply.

1. Model I  7. Model 1000  
 2. Model III/12  8. Model 1200  
 3. Model III  9. Model 2000  
 4. Model 4/4P  10. Pocket Computer  
 5. Model 16/16B/6000  11. Color Computer  
 6. Model 100/200

E. How long have you owned your TRS-80?

1. Less than 1 year  4. 3-4 years  
 2. 1-2 years  5. More than 4 years  
 3. 2-3 years

F. Was it a gift?

1. Yes  2. No

G. Do you plan to purchase another TRS-80 during the next 12 months?

1. Yes  2. No  3. Don't know

H. Where do you use your TRS-80? Check all that apply.

1. At home  
 2. At work  
 3. At school

I. How many children use your TRS-80 for educational purposes?

1. Zero  3. Two  
 2. One  4. Three or more

J. Do you plan to make a purchase based on an ad you saw in this issue of 80 Micro?

1. Yes  2. No  3. Don't know

L. Which of the following columns do you read? Please rate them on a scale of 1 (seldom read) to 5 (always read):

- \_\_\_ 1. Side Tracks \_\_\_ 7. The Spreadsheet Beat  
 \_\_\_ 2. Feedback Loop \_\_\_ 8. Input  
 \_\_\_ 3. Pulse Train \_\_\_ 9. Reader Exchange  
 \_\_\_ 4. Basic Takes \_\_\_ 10. Reviews  
 \_\_\_ 5. The Next Step \_\_\_ 11. New Products  
 \_\_\_ 6. Ask Tandy

M. If you are not a subscriber, please circle 500.

N. If you would like a one year subscription to 80 MICRO, please circle 501 on the Reader Service Card. Each subscription costs \$24.97. (Canada & Mexico \$27.97, Foreign Surface \$44.97, one year only). Please allow 10-12 weeks for delivery.

**Reader Service:** To receive more information from any of the advertisers in this issue, circle the number of the Reader Service Card that corresponds with the Reader Service number on the ad in which you are interested. You will find numbers. Complete the entire card, stamp and drop into a mailbox. In 4-6 weeks you will hear from the advertiser directly.

|                     |                     |                     |                     |
|---------------------|---------------------|---------------------|---------------------|
| 1 6 11 16 21        | 151 156 161 166 171 | 301 306 311 316 321 | 451 456 461 466 471 |
| 2 7 12 17 22        | 152 157 162 167 172 | 302 307 312 317 322 | 452 457 462 467 472 |
| 3 8 13 18 23        | 153 158 163 168 173 | 303 308 313 318 323 | 453 458 463 468 473 |
| 4 9 14 19 24        | 154 159 164 169 174 | 304 309 314 319 324 | 454 459 464 469 474 |
| 5 10 15 20 25       | 155 160 165 170 175 | 305 310 315 320 325 | 455 460 465 470 475 |
| 26 31 36 41 46      | 176 181 186 191 196 | 326 331 336 341 346 | 476 481 486 491 496 |
| 27 32 37 42 47      | 177 182 187 192 197 | 327 332 337 342 347 | 477 482 487 492 497 |
| 28 33 38 43 48      | 178 183 188 193 198 | 328 333 338 343 348 | 478 483 488 493 498 |
| 29 34 39 44 49      | 179 184 189 194 199 | 329 334 339 344 349 | 479 484 489 494 499 |
| 30 35 40 45 50      | 180 185 190 195 200 | 330 335 340 345 350 | 480 485 490 495 500 |
| 51 56 61 66 71      | 201 206 211 216 221 | 351 356 361 366 371 | 501 506 511 516 521 |
| 52 57 62 67 72      | 202 207 212 217 222 | 352 357 362 367 372 | 502 507 512 517 522 |
| 53 58 63 68 73      | 203 208 213 218 223 | 353 358 363 368 373 | 503 508 513 518 523 |
| 54 59 64 69 74      | 204 209 214 219 224 | 354 359 364 369 374 | 504 509 514 519 524 |
| 55 60 65 70 75      | 205 210 215 220 225 | 355 360 365 370 375 | 505 510 515 520 525 |
| 76 81 86 91 96      | 226 231 236 241 246 | 376 381 386 391 396 | 526 531 536 541 546 |
| 77 82 87 92 97      | 227 232 237 242 247 | 377 382 387 392 397 | 527 532 537 542 547 |
| 78 83 88 93 98      | 228 233 238 243 248 | 378 383 388 393 398 | 528 533 538 543 548 |
| 79 84 89 94 99      | 229 234 239 244 249 | 379 384 389 394 399 | 529 534 539 544 549 |
| 80 85 90 95 100     | 230 235 240 245 250 | 380 385 390 395 400 | 530 535 540 545 550 |
| 101 106 111 116 121 | 251 256 261 266 271 | 401 406 411 416 421 | 551 556 561 566 571 |
| 102 107 112 117 122 | 252 257 262 267 272 | 402 407 412 417 422 | 552 557 562 567 572 |
| 103 108 113 118 123 | 253 258 263 268 273 | 403 408 413 418 423 | 553 558 563 568 573 |
| 104 109 114 119 124 | 254 259 264 269 274 | 404 409 414 419 424 | 554 559 564 569 574 |
| 105 110 115 120 125 | 255 260 265 270 275 | 405 410 415 420 425 | 555 560 565 570 575 |
| 126 131 136 141 146 | 276 281 286 291 296 | 426 431 436 441 446 | 576 581 586 591 596 |
| 127 132 137 142 147 | 277 282 287 292 297 | 427 432 437 442 447 | 577 582 587 592 597 |
| 128 133 138 143 148 | 278 283 288 293 298 | 428 433 438 443 448 | 578 583 588 593 598 |
| 129 134 139 144 149 | 279 284 289 294 299 | 429 434 439 444 449 | 579 584 589 594 599 |
| 130 135 140 145 150 | 280 285 290 295 300 | 430 435 440 445 450 | 580 585 590 595 600 |

Name \_\_\_\_\_ Title \_\_\_\_\_

Address \_\_\_\_\_

City \_\_\_\_\_ State \_\_\_\_\_ Zip \_\_\_\_\_

Telephone ( ) \_\_\_\_\_

**80micro** • August 1985



**PLACE  
STAMP  
HERE**

**80 MICRO  
P.O. Box 306  
Dalton, MA 01227**

**PLACE  
STAMP  
HERE**

**80 MICRO  
P.O. Box 306  
Dalton, MA 01227**



Continued from p. 36

ments, and so on). It highlights relevant dates when it displays the calendar.

You use the calculator as you would any other calculator. Your current number appears at the top of the window, and the mathematical operands appear in the lower part of the window. The calculator does offer one nonstandard feature, the Auto key. When you press the A key just before closing the calculator window, the results of calculations you made appear on your current screen at the cursor location. You could, for example, insert a calculated value in a letter or annual report.

The index card window lets you enter text on an electronic 3- by 5-inch card. The same editing features available with Notepad are available here. Monte's Window organizes the index cards by subject line and lets you write up to eight lines of text for each one.

You move forward or backward through the cards in the file with the arrow keys, and you can copy the selected card to the note pad for printing or editing.

Index Cards' most powerful feature is the context search capability. You can enter a partial or complete text pattern as a search argument without regard to case.

Monte's Window supports CP/M system commands, too. From within the window, you can easily display the directory of any disk drive, the amount of free space on a drive, change the current default drive, and erase files.

With the CP/M window, you can also change the current user area any time. This is vital if you have a hard disk system with many user partitions, which is the only way CP/M segregates files (similar to MS-DOS's subdirectories).

### And More

Monte's Window offers some clever features that Montezuma Micro doesn't advertise. For example, you've probably encountered CP/M's dreaded R/O error on a disk or file, forcing you to hit control-C to exit a program, thereby losing your files. Monte's Window won't accept this command, and it intercepts control-C's warm boot and tries to return you to the running program.

In addition, you can implement Monte's Window without using the shift keys; you just invoke the program through a system call to address 0040H (in the reserved CP/M area).

### Conclusion

Monte's Window performs well. After the novelty of calling windows and using concurrent applications wears off, you'll find so many uses for the collection of programs that you won't know how you did without them. ■

## Major Math For Math Majors

by Thomas L. Guindry

★★★

The Math Master Series runs on the Model III and requires one disk drive. PAB Software Inc., P.O. Box 15397, Fort Wayne, IN 46885, 219-485-6980. Various math modules \$24.95 to \$39.95 each.

Easy to use: ★★☆☆☆

Good docs: ★☆☆☆☆

Bug free: ★★☆☆☆

Does the job: ★★★★★

The Math Master Series of programs are highly specialized Basic language packages for the engineer, scientist, or math student, that is, the serious math user rather than the average computerist. The programs provide mathematical functions for matrix, polynomial, and vector arithmetic and fast Fourier transforms (FFTs), but they're somewhat awkward to use and the documentation isn't that enlightening.

PAB offers each math module separately, which is advantageous if you need only one module, but adds up to a lot of money if you have to buy them all. The modules perform their routines on matrix or array variables.

### Up and Running

To use a particular function, you have to load the module and protect high memory. Next, you load and run the supplied initialization program. Then you run the Basic program containing the calls to the module, which are made through the /CMD statement. For example, to use the Matrix Master single-precision module, the statement `CMD MAT A = B + C`, sets matrix A equal to the sum of matrixes B and C.

The initialization program is the same for all modules. It sets up a DEFUSR function and calls it by way of the USR function to install the CMD pointer.

If you use more than one math module in a program, you have to use the Math Master executive module, which loads other modules. You can have only one module resident in a program at a time since the modules overlay practically the same memory area. The Math Master executive analyzes the /CMD function and loads the math functions as needed.

The Math Master Series has one major flaw. It provides no error-checking to verify that you've initialized a program; if you try to initialize a module more than once, the computer hangs up. And the series doesn't support Model III

TRSDOS's `CMD L` command to load the modules as needed, because you need to reinitialize.

### The Modules

You can use each of the Matrix Master modules (single- or double-precision, scaler, or complex) to execute a series of math functions on a matrix: addition, subtraction, and multiplication; scalar (or complex) addition, subtraction, multiplication or division; transpose; inverse; scalar (or complex) variable assign; matrix assign; identity matrix, determinant; and disk or tape input/output functions.

The command structure is similar for each module and PAB provides an example of solving a simultaneous linear equation using the single-precision Matrix Master. The Matrix Master functions are matrix inverse and matrix multiply.

The single- or double-precision Poly Master modules provide a series of polynomial functions for initialization, math, and general manipulation. These modules perform addition; subtraction; multiplication; division; derivative; integral; assignment; value; greatest common divisor; normalize; scalar addition, subtraction, multiplication, and division; scalar assign; and disk and tape input/output functions. Command structure is similar for each module. The single- or double-precision Poly Root Master modules add the commands, `Root` and `ROOTD`, allowing polynomial root computations.

The single- and double-precision and scaled integer fast Fourier transform modules provide analyses using several different qualifiers. The qualifiers are real, inverse, Hanning weighting, magnitude, and phase of the transformed data. You don't have to use a qualifier, however, and you can input and output the arrays to a disk file.

### Conclusion

The Math Master Series' documentation runs from only eight to 17 pages for each module. PAB assumes that the user has a working knowledge of matrix and/or fast Fourier transform arithmetic rules and terminology. The instructions are minimal and barely adequate.

This program could be easier to use. It is rather archaic to have to remember the correct memory size to protect each time you use one of the packages.

Though these problems exist, good math packages are hard to find. A highly technical user with specific applications would find these packages useful. Since similar packages are available for the IBM PC and Apple II, it would be easy to transport the Basic programs produced with a minimum of fuss. ■



The  
**Master Handicapper™**   
Series by Professor Jones

**EVALUATES FROM RACING FORM!**

|             |                |              |
|-------------|----------------|--------------|
| Age         | Gender         | Post (Today) |
| Class       | Jockey (Today) | Post (Last)  |
| Condition   | Jockey (Last)  | Speed        |
| Consistency | Length         | Trainer      |
| Earnings    | Time of Year   | Workouts     |

And gives you GRAPHIC REPRESENTATION of finish

**PROGRAM** 

**GLD. Thoroughbred "Gold" Edition™**

A "Full" featured thoroughbred analysis designed for the professional and serious novice. **\$159.95** complete

**EGLD. Enhanced "Gold" Edition™**

"Gold" Edition with complete Master Better™ system integrated onto the same disk. This powerful program will transfer all horses and scores to the bet analysis with a "single keystroke."  
(Master Better™ included) **\$199.95** complete

**GLTD. Limited "Gold"™**

Enables Professional Handicappers to assign specific values to the racing variables "they" feel are important.

**PROFESSIONAL HANDICAPPING SYSTEMS**

|              |                        |                |
|--------------|------------------------|----------------|
| %            | %                      | %              |
| Age 5        | Consistency 15         | Speed 10       |
| Class 15     | Jockey 15              | Workouts 0     |
| Condition 10 | Trainer 5              | Time of Year 0 |
| Earnings 5   | Post 10                | Consistency 5  |
| 100%         | Is Everything OK (Y/N) |                |

Create program weight based on a particular track and fine tune it for maximum win percentage. This program is designed for "ease of use" The user needs **no programming experience.**

(contains Integrated Better™) **\$299.95** complete

**GD. Gold Dog Analysis™** 

The only professional dog handicapper on the market. includes:

- 1) Speed
- 2) Post Today
- 3) Kennel
- 4) Post Last
- 5) Distance
- 6) Condition
- 7) Running Style
- 8) Weight
- 9) All new internal weighting
- 10) NEW class indicator

If you are near a greyhound track, you can't afford not to use this program

**\$149.95** complete

(with integrated Master Better™) **\$199.95**

**Limited Dog™ \$299.95**

**MHH. Master Harness Handicapper™** 

Professional software designed to provide a thorough analysis of all trotter and pacer races in North America and Canada. Features:

|                 |                  |                   |
|-----------------|------------------|-------------------|
| Class           | Post Positions   | Time Finish       |
| Driver          | Track Conditions | Time Last Quarter |
| Days Since Last | Trainer          | Track Rating      |
| Gender          | Time ¼           | Temp Allowance    |

**\$159.95** complete w/Integrated Master Better™ **\$199.95**

**PPX. Professor Jones' Football Predictor, Prof. Pix™**

Complete Football Analysis with Data-Base.

- 1) Overlays
- 2) Point Spreads
- 3) "Super Plays"
- 4) "Over/Under" bets
- 5) Data Base Stats
- 6) Holds "100" teams

Highest percentage of winners 1983 **\$39.95** complete

**\$99.95** with Data Base Management

**NBA. Basketball™**

This data base managed analysis will provide the user with "ALL" betting situations while storing relevant information on the disk

**\$99.95** complete w/Manual **\$129.95** NBA/College Version

**LOT. LOTTERY ANALYSIS™**

Statistical comparison program designed to detect subtle patterns in winning lottery numbers

**\$79.95** complete w/Manual **\$99.95** with Lotto

**BROCHURE AVAILABLE**

Send check / money order / VISA / Mastercharge (Include expiration date) to:



TELEPHONE  
(208) 342-6939

**Prof. Jones**  
1940 W. State St.  
Boise, ID 83702



TERMS: FREE SHIPPING ALL SOFTWARE. Add \$6.00 hardware / \$6.00 C.O.D. / UPS Blue \$6.00 / Out of Country \$9.00 / ID Residents 4% / 3 weeks personal checks / Cash price only, add 2% Visa, MC / Prices subject to change.

**IBM, APPLE, TRS-80, C-64 AND OTHERS**

**EXPRESS CHECKOUTS**

**Pro-Create 4.3**

★★★★★

**Pro-Create 4.3** runs on the Model 4 (64K) and requires one disk drive. Misosys, P.O. Box 4848, Alexandria, VA 22303. \$74.95.

Misosys's biggest change to their new version of Pro-Create is in their implementation of the editor/assembler. Previously, Pro-Create featured only EDAS, its combined editor/assembler; Pro-Create 4.3 not only includes EDAS, it also has stand-alone versions of EDAS's macro assembler and line editor.

In addition, Misosys includes Said in this package, an impressive full-screen text editor that supports many word processor features: insert and overtype, text delete and undelete, block copy and move, and string search and replace. Said also supports macro keys; the ability to edit three files at once on a 128K machine; a help display; a reverse Polish notation calculator for binary, hexadecimal, and decimal values; and customized keyboard mapping with an installation program.

Pro-Create offers enhancements to its original macro assembler, too: eight new expression operators; support for the Intel macros REPT, IRPC, and IRP; three new conditionals for controlling a program's assembly; an include assembler directive; an EXITM pseudo-op for premature exits from macro expansions; an Option pseudo-op altering the assembler switches from within the source code; and an MF switch that instructs the assembler to search the macro table before the opcode table. In addition, the assembler's easier to use than before.

—Mark D. Goodwin

**Microsoft Word 2.0**

★★★★★

**Microsoft Word 2.0** runs on the Models 1000 and 1200 (256K) and requires two disk drives (color graphics recommended). Microsoft Corp., 10700 Northup Way, Bellevue, WA 98009, 206-828-8080. \$375 (includes mail merge and spelling checker with 80,000-word dictionary).

Just as a Ferrari shouldn't be your first car or an F-16 your first plane ride, Microsoft Word shouldn't be your first word processor. If you don't know basic word processing operations, like block moves and boldface, you can't appreciate Word for what it is: a first-strike thermonuclear word processor. This ain't no Scripsit. This ain't no HomeWord. This ain't no fooling around.

Word has more power than most users will ever need. Not only can it keep eight

windowed documents in memory at once and produce a finished book or magazine page on a laser printer, it makes editing with function keys almost as quick and simple as using a mouse. And with Microsoft's mouse, no other software (Macintosh included) is easier to use.

Word is an ultimate version of the Model 100's cut-and-paste editor. You use the function and arrow keys to cut, reformat, or otherwise manipulate text. The most recently cut text goes to a scrap buffer to be relocated or undeleted at a touch of the Insert key.

It also makes on-screen formatting a gleeful what-if game. A few keystrokes can display your text in centered italics, flush-right small caps, justified double or single underlining, indented boldface, or any combination you can think of.

Not only can Word display all these formats, it lets you specify type fonts, sizes, and different options for individual characters. The multilayered commands for these marvels take some practice, but their structure is logical and there's ample on-screen help.

For printing, Word replaces embedded commands with auxiliary disk files called style sheets. You can print text as a plain, double-spaced draft or as a single-spaced, justified, two-column final copy with footnotes, lowercase Roman-numbered pages, and extra space on inside margins for binding.

Before reviewing the IBM PC edition, I briefly tested the Tandy-packaged Word (version 1.15) for the 1000. I'm sure Tandy has updated to version 2.0 by now, but I'd still recommend the Microsoft package. Not only is it cheaper to buy at discount (advertised as low as \$239), but it has drivers for over 50 different printers, instead of only eight or 10 Tandy units.

—Eric Grevstad

**The Norton Utilities 3.0**

★★★★★

**The Norton Utilities 3.0** runs on the Tandy 1000/1200/2000 (128K) or any IBM PC-compatible computer that runs MS-DOS 2.X. The Norton Utilities, 2210 Wilshire Blvd., Santa Monica, CA 90403. \$99.95.

If you've ever wished that you hadn't inadvertently erased a file or that you had an easy way to get more information on your disk files, The Norton Utilities can help—and at a bargain-basement price.

On boot-up, The Norton Utilities displays a menu from which you choose the individual utilities of interest. A graphics



## EXPRESS CHECKOUTS

display indicates where each file resides on the disk and provides information about the file.

The package's 16 programs perform all sorts of disk magic. One utility, File Find, searches all directories for a given file name. Another (Text Search) searches all disk files for a specific text string. A third, Directory Sort, sorts entries contained in a specified directory by either file name, extension, date, and time or file size, and rewrites the directory, rearranging all entries in the specified order.

The Screen Attributes utility controls the background and foreground colors of your display, along with other screen attributes such as blinking, underlining, and reverse video. The System Information utility returns information about your computer such as the type of computer you're using, the revision level of your operating system, the number of logical disk drives, and the amount of memory in the system.

Without a doubt, the Norton Utilities is worth every penny, and it's easy to use to boot.

—Gary A. Shade

## Mod-4 by Jack

★★★★

**Mod-4 by Jack.** Softcover, 218 pp. Crest Software, 2132 Crestview Drive, Durango, CO 81301. \$16.

While the *Model 4 Disk System Owner's Manual* is a good reference, its bloated size can limit its usefulness. *Mod-4 by Jack* puts essentially the same information into a more manageable 6-by 9-inch spiral-bound book. While it's missing some information, it is a good source for day-to-day needs.

Jack's organization is identical to that of the *Disk System Owner's Manual*. But *Mod-4 by Jack* is written in a more readable style than Radio Shack's manual. And the book uses better examples and illustrations to explain TRSDOS and Basic commands. The book also provides ample space for making notes for future reference.

Jack left out a few important facts, however. The book's only reference to the TRSDOS job control language (JCL) states that the JCL is useful and that you should read the manual for more details. Also, there aren't any explanations for the Basic Width statement and logical operators. Like the Radio Shack manual, *Mod-4 by Jack* doesn't provide any machine-language programming information.

Despite its few drawbacks, someone who refers to the manual every day might find *Mod-4 by Jack* more convenient than Radio Shack's oversized opus.

—Mark D. Goodwin

Circle 392 on Reader Service card.

# Now Dell® & The New York Times® Crossword Puzzles Run On Your Computer.

Since Arthur Wynne ran the first crossword puzzle in a 1913 newspaper, millions of Americans have become devoted puzzle solvers. Now you can be challenged by the best crossword puzzles from either The New York Times or Dell on your personal computer.

And you can do it with all the convenience computers offer:

Ask for hints, check answers, erase, save partial puzzles and much more. Beginners can use Computer Crosswords to become accomplished puzzlers. Experts can test their skills—even match wits with friends in contests.

Each diskette comes with 30 puzzles and sells for only \$19.95. Order both for \$34.95 and save

\$5. Satisfaction is unconditionally guaranteed for 90 days from the date of purchase. Send a check or money order to Computer Crosswords, P.O.B. 60010, San Diego, CA 92106. Add \$2.50 for postage and handling. (California residents add 6% sales tax). We will ship C.O.D., or you can charge the puzzles to your MasterCard or VISA:

## Call 800-325-1289

California residents call 619-224-3788.

We'll deduct \$.75 from the handling charge to cover California calls.

## Memories Are Made of This

### ACROSS

- 1 - Tie over, in music  
5 - Follows character  
10 - Chooses raster  
14 - Video  
15 - Endearing word, to Maurice  
16 - Home of the Jazz  
17 - Rummage sale words  
18 - Consumer  
19 -

- shanter (cap)  
20 - Mathematical function  
22 - Compute arithmetically  
24 - Part of a video-game machine  
25 -

- quand (where or when); French  
26 - Frequent error message  
29 - Hard-copied  
32 - Seventeen, to a computer  
33 - Campus orgs.  
34 - A class of memory, for short  
36 - Run smoothly  
37 - Is down  
38 - Word for the White Rabbit

- 50 - A Turning Machine?  
54 - Arc; abbr.  
55 - Wake up  
57 - Rush-hour component  
58 - City on the Truckee  
59 - A class of memory, for short  
60 - Small weight  
61 - Hebrew month  
62 - Part of a Mae West line  
63 - Tolkien trees

### DOWN

- 1 - Tito was one  
2 - A big Apple  
3 - Join, in Madrid  
4 - Computer component  
5 - Item in granny's kitchen  
6 - Part of a Commandment

- 7 - Head of France?  
8 - Former Eng. Soc.  
9 - They're in the chips?  
10 - Computer production  
11 - Chief god of Memphis  
12 - Unexciting  
13 - Toots of restaurant fame  
21 - Four-sevenths of a fronton game?  
23 - Charged atoms  
25 - Examinations  
26 - Small tastes

- 27 - "I'll look sometime"  
28 - Marilyn's real name  
29 - Lions' group  
30 - Clear  
31 - Post office machine  
33 - Dracula's strong points?  
35 - Military dining area  
37 - Newspaper specialties  
38 - It needs an interpreter  
40 - Agenda, for short  
41 - Tandy, for one; abbr.  
43 - Musical key

- 44 - The same, in Paris  
46 - buddies  
47 - Part of XL, in shirt sizing  
48 - "I gave my love  
red rose"  
49 - Emile Zola novel  
50 - Panacea  
51 - Twist  
52 - State of France?  
53 - A class of memories, for short  
56 - Unshutter, to Shakespear

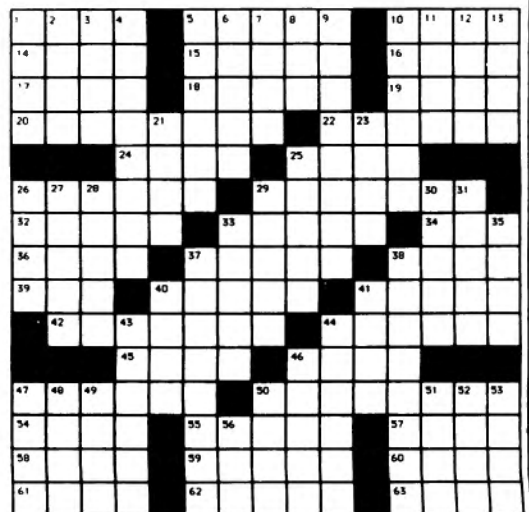

System requirements: 48k—TRS-80\* I, III, & IV; IBM\* PC or compatible (e.g., Tandy 1000\*) Apple\*II; Commodore\*; Atari\*

Purchase the puzzles or circle the Reader Service number and we will send you the answers to this original Computer Crosswords puzzle.

## COMPUTER CROSSWORDS™

\*Registered Trade Mark

©EVOLVING TECHNOLOGY COMPANY



# \$777

**NEW!**

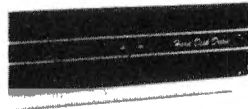

# 5 MEG HARD DRIVE

**Comes complete with cable  
and choice of software driver\***  
(CPM, LDOS, TRSDOS)

- 10 Megabyte Hard Drive..... **\$899**
- 15 Megabyte Hard Drive..... **1095**
- 30 Megabyte Hard Drive..... **1495**

## SYSTEM FEATURES

- For TRS-80 Model 3-4-4P
- One Year Parts & Labor Warranty
- Size Rated After Format
- Continuous Duty Power Supply
- Error Checking & Correcting
- Continuous Duty Fan
- Size 11.5" x 12.5" x 5.0"
- All Contacts Gold Plated

\*Model 3 requires LDOS

Model 4 requires TRSDOS 6.2 or Montezuma Micro CP/M 2.2

There are firms which offer benefits, experience or products seemingly too good to be true. Now why would you want to expose yourself to unhappiness when Aerocomp has a proven record of thousands of happy, satisfied TRS-80 customers. Just take a minute to look through back issues of this magazine. You won't find many companies that have been around as long as Aerocomp. We fully support TRS-80 computers and most all operating systems including CP/M 2.2. Aerocomp leads the way to low hard disk prices so you can afford to enjoy the benefits of increased storage and faster disk I/O. These units are precision engineered, tested and delivered complete and ready to use, right from our stock. Each unit is guaranteed for one year parts and labor. You can count on us to be here if you should ever need us. As always, your satisfaction is assured with our 14 day free trial offer. If, for some reason, you are dissatisfied with our drive merely return it for a full refund (less shipping). How can you go wrong? Specify the software driver of your choice and start enjoying your computer's real capability. Do it today! Call our toll-free number now!

**See opposite page** ▶▶▶▶▶▶

## MODEL I DOUBLE DENSITY BOARD

**Add 80% more capacity to your disk system with the Double Density Controller (DDC) from Aerocomp.**

### The Story

Some products have what it takes to seem to last forever. Our "DDC" is one of those products. What it does is allow you to operate your TRS-80 Model 1 disk system in double density. In this case double density means almost doubling the storage capacity of your diskettes. Single density, that's the way Radio Shack designed your Model I expansion interface, organizes your disk into 10 sectors per track. Each sector contains 256 bytes of data for a total storage capacity of 2,560 bytes or 2.5K per track times the number of tracks your drive is capable of addressing. Double density, on the other hand, writes 18 sectors per track each containing 256 bytes for a total of 4,608 bytes or 4.5K. That is 80% more data in the same space. Why didn't Radio Shack do that in the beginning, you ask? Well it costs money to do double density because it is more difficult to do than single density and the data is harder to capture reliably. That means more cost and the Model I was meant to be a low-cost computer for the masses. Therefore, no double density for the original Model I.

### The Facts

Other companies introduced double density controllers for the Model I but they were not so good. We waited and waited but, even new models failed to correct problems with data separation that kept cropping up. So we went to work and came up with a new design to cure the old problem. At last! A double density controller for the Model I with a higher probability of data recovery than with any other double density controller on the market then or since. Our analog design phase lock loop data separator has a wider capture window than the digital types the others use. This allows high resolution data centering. Our "DDC" analog circuit allows infinitely variable tuning. The attack and settling times are optimum for 5.25" diskettes. The oft-stated fears of adjustment problems rumored by digital dilettantes have been proved groundless by thousands of satisfied users the world over. The bottom line here is state-of-the-art performance and reliability.

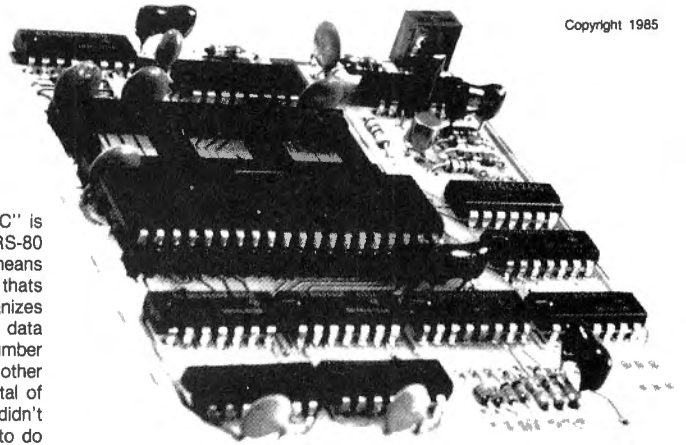

Copyright 1985

### ORDER YOURS TODAY

TRS-80 Model I disk system owners who are ready for reliable double density operation will get 80% more storage per diskette; single and double density data separation with far fewer disk I/O errors; single density compatibility; simple plug-in operation. You will need a disk operating system that has the necessary double density software. All the popular DOS's (except TRSDOS) have the drivers. We have put together two special packages in the event you don't already have one of the more popular DOS's.

Please add \$4 handling & shipping

- "DDC" by itself..... \$ 99**
- "DDC" and LDOS..... 159**
- "DDC" and NEWDOS 80 2.0 .... 179**



- ☞ 40 Track
- ☞ 80 Track
- ☞ Single Head
- ☞ Dual Head
- ☞ Bare
- ☞ Complete
- ☞ Full Size
- ☞ Half Size

# DISK DRIVES

Aerocomp leads the way to the BEST value in disk drives and related peripheral products on the market today. Sound engineering, high performance, quality construction, no-risk free trial, outstanding warranty service and a reputation for doing the right thing make your decision to buy Aerocomp the correct one. Please look over our offerings and make your selection. When you have made your choice call our toll-free number and place your order. If you need assistance in making your selection, please call our information number. It's listed in the box at the bottom of this ad along with the technical assistance number for those of you who want to get right to the nitty-gritty. Thanks, we all appreciate your business and will continue to do our very best to support you.

## BARE DRIVES Add \$4 S&H

These drives are completely burned-in and tested for your ultimate satisfaction. Add that extra drive today! These are new factory drives. No blems, seconds or closeouts. Instruction manual included at no extra cost. Service manuals are available. See "Miscellaneous Goodies" for info.



- 40tk SS full size Tandon TM100-1 .....\$ 129
- 40tk DS full size Tandon TM100-2 .....169
- 40tk SS half high TEAC FD55-A.....129
- 40tk DS half high TEAC FD55-B.....169
- 80tk DS full size Tandon TM101-4 .....289
- 80tk DS half high TEAC FD55-F.....239
- 8" SS Thinline Tandon TM848-1E.....260
- 8" DS Thinline Tandon TM848-2E.....335

## 8" FLOPPY DRIVES Add \$12 S&H

These 8" Thinline drives work with the Model 2 and 16 plus others that use standard drives. The rugged all-steel cabinet has an extra heavy duty power supply rated for continuous operation. A removable air filter allows only clean air to circulate. Cabinets with single drives are supplied with a blank panel to cover the unused space. A second drive can be added at any time. Service manuals are available. See "Miscellaneous Goodies" for info.



- 1-8" SS Tandon TM848-1E & case .....\$ 389
- 2-8" SS Tandon TM848-1E's & case .....649
- 1-8" DS Tandon TM848-1E & case .....439
- 2-8" DS Tandon TM848-2E's & case .....699

## MISCELLANEOUS GOODIES \$2 S&H

- Model 1 TRSDOS 2.3 disk & manual.....\$ 25
- Model 3 TRSDOS 1.3 disk & manual.....25
- Model 4 TRSDOS 6.2.x disk & manual.....20
- LDOS (specify Model I or III).....69
- NEWDOS 80 v2.0 (specify Model I or III).....99
- Montezuma Micro Model 4 CP/M 2.2 .....169
- Tandon TM100-1/2 Service Manual .....20
- Tandon TM848-1/2 Service Manual .....20
- TEAC FD55A/B/F Service Manual .....20
- 10 SSDD disks in library box, Lifetime Guar .16
- 10 DSDD disks in library box, Lifetime Guar .19
- 5.25" drive power supply & enclosure.....59
- 8" drive pwr sply & encl w/fan 5V-24V .....150
- 5.25" 1-drive cable, a nice length.....19
- 5.25" 2-drive cable, a 44 incher.....24
- 5.25" 3-drive cable, just the right size .....29
- 5.25" 4-drive cable, the top dog.....34
- 5.25" Extender cable with gold contacts.....10

## COMPLETE DRIVES Add \$6 S&H

Fits TRS-80 Models 1,3,4 and the Color Computer plus the others that use standard drives. The drive of your choice is mounted in a sturdy, all-steel cabinet. An external gold plated drive connector allows cabling without disassembly of the cabinet. Half-high drives come in a full-size cabinet that will hold and power our half-high drives. Single drives have a panel covering the unused space allowing a second drive to be added at any time. All are shipped fully assembled ready to use. Specify silver or white enclosure.



- 40tk Single Side full size (TM100-1).....\$ 169
- 40tk Double Side full size (TM100-2).....199
- 80tk DS full size (TM101-4).....299
- 1-40tk SS half-high FD-55A in dual case .....169
- 2-40tk SS half-high FD-55A's in dual case...319
- 1-40tk DS half-high FD-55B in dual case .....199
- 2-40tk DS half-high FD-55B's in dual case ...359
- 1-80tk DS half-high FD-55F in dual case.....219
- 2-80tk DS half-high FD-55F's in dual case...389

## FREE TRIAL OFFER

Use your Aerocomp hardware product for up to 14 days. If you are not satisfied for ANY REASON (except misuse, damage or improper handling), return it (insured) in the original shipping container for a full purchase price refund, less shipping. Sorry, this offer does not apply to software. Defective software will be replaced. Any hardware/software specials will be prorated and the software will be charged at the regular unbundled price. We have confidence in our products and we know you will be satisfied.

## WARRANTY

We offer a one year warranty on parts and labor against defects in materials and workmanship. In the event service becomes necessary for any reason you will find our service department fast, friendly and cooperative. We want to keep you happy. Out of warranty repairs are also available.

## 100% BURN-IN and TEST

All our products are burned-in and fully tested prior to shipment. We want you to receive an item ready-to-go. AEROCOMP means reliability!

## ORDER NOW!

Call our toll-free number service and place your order. Have your American Express, Mastercharge or Visa number ready. We will not charge your card until the day we ship your order. You may order by mail using your credit card, check or money order. Personal and company checks are welcome and cause no shipping delay as long as they are bank printed and the signature exactly agrees with the name printed on the check. We will ship surface COD with no deposit but all COD's require cash or a cashier's check on delivery. Texas residents add 6% State Sales Tax. No tax collected on out of state shipments. Canadian addresses add \$20 to your order if over \$550 for customs documentation.

## TRS-80 Model III & 4 DISK CONTROLLER and DRIVE KITS

Convert your cassette Model III or 4 to disk operation with one of our complete kits. You receive our own advanced disk controller board with gold plated edge contacts capable of 4-drive operation; our own power supply; plated steel mounting towers complete with RFI shield plus all the cables and hardware necessary. Detailed instructions are included. All you need is a screwdriver and a pair of pliers. System kits come with 40 track single-side drives or just order the basic kit and pick the drives you want from the selection in the next column.

### CONTROLLER KIT .....\$ 199

(Everything you need - less drives/DOS)

### 1 DRIVE SYSTEM.....319

### 2 DRIVE SYSTEM.....439

Add \$8 S&H

### MOUNTING KIT & POWER SUPPLY .....95

Add \$8 S&H

### CONTROLLER BRD. ONLY ..110 RS-232 BOARD & KIT .....69

Add \$4 S&H

## OUR FAMOUS MODEL I STARTER PACKAGE

If you have a Model I and an Expansion Interface this is what you need to get started with disks. Included is one 40 track single-side disk drive complete with matching silver case and power supply, a 2-drive cable, a TRSDOS 2.3 disk operating system and TRSDOS manual plus all insurance and delivery charges to your door (lower 48 states).

Yours for only **\$ 199**

You can add our renown "DDC" double density controller to either the Radio Shack or the LNW Expansion Interface for 80% more storage capacity on your drive. Order it at the same time as our starter package above and we'll pay the shipping. Go ahead, you deserve increased density. See the opposite page for the latest technical details.

**\$ 99**

## CALL TOLL-FREE

**800-527-3582** USA  
**800-442-1310** TEXAS

For inquiries or information  
or to check on or change an order  
call 214-339-8324

**AEROCOMP**  
Redbird Airport, Bldg. 8  
P.O. Box 24829  
Dallas, TX 75224



### Color Me In

Sharp's four-color, high-resolution plotter, the CE-515P (\$399), connects to most personal computers that run Basic. Sharp will initially bundle the plotter with Softkey's Keychart software, which provides IBM PC compatibility.

The plotter uses black, blue, green, and red colors that change over automatically. For more information, contact Sharp Electronics Corp., System Division, 10 Sharp Plaza, Paramus, NJ 07652, 201-599-3853.

Circle 567 on Reader Service card.

### Changing Around

Gee-Whiz Convert (\$99.95) from The Alternate Source converts IBM and IBM-compatible Basic programs to Model 4 Basic. It even handles graphics programs written for the Radio Shack or Grafix Solution high-resolution boards. In addition, Gee-Whiz includes several functions and subroutines that you can incorporate into your new Model 4 programs.

Contact The Alternate Source (704 N. Pennsylvania, Lansing, MI 48906, 517-482-8270) for further information.

Circle 555 on Reader Service card.

### Manage Yourself

Little Brother (\$99) is a new data management system from Logical Systems Inc. It's available for the Model 4/4P running TRSDOS 6.2 or PC/MS-DOS 2.0 users.

Little Brother handles up to 65,534 records where each record can contain up to 1,024 bytes. It supports up to 64 different data fields of from 1-254 bytes. Nine dif-

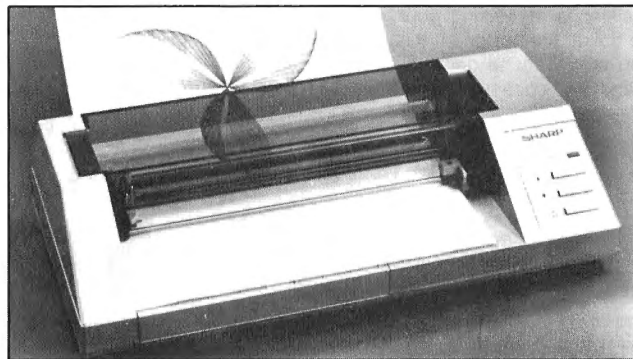

CE-515P, a multifunction plotter from Sharp.

ferent types of data fields are available.

For ease of use every function is menu-driven and on-line help is always available.

Contact Logical Systems Inc., 8970 N. 55th St., P.O. Box 23956, Milwaukee, WI 53223, 414-355-5454 for more details.

Circle 565 on Reader Service card.

### Author's Helper

Autoref (\$89.95) compiles reference lists of citations made in manuscripts. It works with most word processors and runs on MS-DOS, CP/M-80, and CP/M-86 computers and on the Models I, II, III, 4, 12, and 16.

Autoref automatically finds author citations (in name/date format) in text and alphabetizes them. Then it retrieves a complete reference from a master reference file and builds the document's bibliography. You can create and maintain the master file with Autoref, a word processor, or a data base manager like dBase II or III.

For more information, contact Scilab Inc., P.O. Box 614, Guilderland, NY 12084, 518-355-3363.

Circle 557 on Reader Service card.

### Super Data

The Institute for Scientific Analysis Inc. offers a new version of Super, a Xenix-based menu-driven data base management system for the Models 16 and 6000.

Super provides you with simple-to-use data entry, data manipulation, and a report generation system. Automatic record locking lets multiusers access the same data files. The system can handle up to 60 fields and 32,767 records.

The program requires MBasic and sells for \$295. For more information, contact ISA, 36 E. Baltimore Pike, Suite 106, Media, PA 19063, 215-566-0801.

Circle 561 on Reader Service card.

### Open Windows

SASSE (\$75) from En Fleur Corp. is a free-form filing system for the Model III that takes full advantage of its windowing capability.

The program offers a word processor and multitasking features. You can write memos and save them to disk, call the help or operations manual in the midst of an operation, print or sort a file while working on another, and stack seven windows of

various information at one time.

Using simple key commands you can edit, write, read, sort, and print any file. SASSE displays each file within its own window and you can scroll them up or down. You can display four record windows within a file at any given time. When you have selected a record you can enlarge the window to show a full view of the text.

You need a 48K, two-disk Model III and TRSDOS to run SASSE. For more details, contact En Fleur Corp., 2494 Sun Valley Circle, Silver Spring, MD 20906, 301-598-4532.

Circle 572 on Reader Service card.

### Phonics Fun

K-12 MicroMedia's new phonics program for the Models III and 4, Starting with Phonics, provides more than 1,200 games for practicing phonics with fourth- to sixth-graders. You can use it individually or in small groups. K-12 MicroMedia also offers Winning with Phonics for grades 5-7.

Both packages are \$39.95. Contact MicroMedia (172 Broadway, Woodcliff Lake, NJ 07675, 800-922-0401) for more details.

Circle 559 on Reader Service card.

### Assembly Line

Christopher Lampton's *Z80 Assembly-Language Programming for Radio Shack, Timex Sinclair, Adam, and CP/M Computers* presents a tutorial on assembly language for programmers already familiar with Basic or other high-level languages.

The book is available for



From Computer Plus to YOU...

# PLUS after PLUS after PLUS



Tandy 200 24K \$739  
Model 100 8K \$339  
Model 100 24K \$425



Color Computer II  
w/16K Ext. Basic \$135  
w/64K Ext. Basic \$179



Tandy 1000 \$799  
Tandy 1200 \$1599

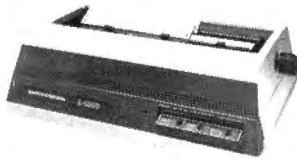

Smith Corona L-1000  
\$259

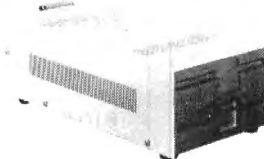

Color Computer Disk Drive  
Drive 0 \$279 Drive 1 \$169

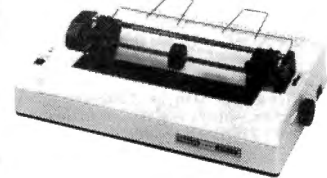

DMP105 \$160

## BIG SAVINGS ON A FULL COMPLEMENT OF RADIO SHACK COMPUTER PRODUCTS

### COMPUTERS

|                         |         |
|-------------------------|---------|
| Tandy 1000 1 Drive 128K | 779.00  |
| Tandy 1200 10 Meg. 256K | 1599.00 |
| Tandy 2000 2 Drive 256K | 1295.00 |
| Tandy 2000 10 Meg. 256K | 2025.00 |
| Model IV Portable 64K   | 559.00  |
| Model IV Desktop 64K    | 959.00  |

### PRINTERS

|                                 |        |
|---------------------------------|--------|
| Radio Shack DMP-110             | 299.00 |
| Radio Shack DMP-430             | 660.00 |
| Radio Shack DWP-220 Daisy Wheel | 469.00 |
| Radio Shack TRP-100 Portable    | 229.00 |
| Silver Reed EXP-550 Daisy Wheel | 430.00 |
| Star Powertype Daisy Wheel      | 345.00 |
| Star SG-10                      | 245.00 |
| Star SG-15                      | 410.00 |
| Star SD-10                      | 365.00 |
| Panasonic P-1091                | 275.00 |
| CITOH Prowriter 8510AP          | 320.00 |
| CITOH 7500                      | 230.00 |
| Okidata 192                     | 389.00 |
| Okidata 193                     | 539.00 |
| Epson                           | CALL   |

### TANDY 1000/2000 ACCESSORIES

|                                  |        |
|----------------------------------|--------|
| Tandy 1000 Disk Drive Kit        | 159.00 |
| 256K Ram Board (inc. 128K & DMA) | 199.00 |
| 512K Ram Board (includes 128K)   | 169.00 |
| 128K Ram Upgrade Kit (Tandy)     | 135.00 |
| 128K Ram Upgrade Kit (NEC)       | 98.00  |
| 300 Baud Modem Board             | 129.00 |
| RS-232 Serial Board              | 89.00  |
| Hard Disk Controller Board       | 249.00 |
| Digi-Mouse/Clock Board           | 89.00  |
| Tandy VM-2 Green Monitor         | 129.00 |
| Tandy CM-2 RGB Color Monitor     | 379.00 |
| Tandy VM-3 TTL Green Monitor     | 179.00 |
| Tandy 1200 Text Monitor Adapt.   | 179.00 |
| Tandy 1200 Color/Graphics Adapt. | 240.00 |

### MODEMS

|                              |        |
|------------------------------|--------|
| Radio Shack DCM-3            | 52.00  |
| Radio Shack DC Modem IB      | 89.00  |
| Radio Shack DC Modem II      | 160.00 |
| Radio Shack DC Modem 2212    | 315.00 |
| Hayes Smartmodem II 300 Baud | 215.00 |
| Hayes Smartmodem 1200 Baud   | 429.00 |
| Novation J-Cat 300 Baud      | 115.00 |

### MODEL III/IV ACCESSORIES

|                           |        |
|---------------------------|--------|
| PTC-64K Printer Buffer    | 199.00 |
| Model III/IV Drive 0 Kit  | 465.00 |
| Model III/IV Drive 1 Kit  | 220.00 |
| Model III/IV Hi-Res Board | 229.00 |
| Model III/IV RS-232 Board | 99.00  |
| Model IV 64K Upgrade Kit  | 79.00  |

### FOR EVERYONE

|                                    |       |
|------------------------------------|-------|
| Radio Shack Powerline Filter       | 45.00 |
| CCR-81 Cassette Recorder           | 52.00 |
| CCR-82 Cassette Recorder           | 43.00 |
| C-20 Digital Cassette Tapes (10pk) | 9.95  |
| Verbatim SSDD Plastic Box (10pk)   | 24.95 |
| Verbatim DDDD Plastic Box (10pk)   | 34.95 |
| Generic SSDD Diskettes (10pk)      | 17.95 |
| NEC 64K Ram Chips (set of 8)       | 39.00 |
| Radio Shack 16K Ram Chips (8)      | 25.00 |
| Locking Disk Box (holds 70)        | 19.95 |
| Flip N File Disk 50                | 15.00 |
| Fanfold CleanEdge Paper (2600)     | 35.00 |

Radio Shack software 10% off.  
Send for complete listing of  
brand name software and hardware.

**CALL TOLL FREE  
1-800-343-8124**

- LOWEST POSSIBLE PRICES
- BEST POSSIBLE WARRANTY
- KNOWLEDGEABLE SALES STAFF
- TIMELY DELIVERY
- SHOPPING CONVENIENCE



# computer plus

P.O. Box 1094  
480 King Street  
Littleton, MA 01460

**SINCE 1973**

IN MASSACHUSETTS CALL (617) 486-3193

**Wow! Over 170 Formats!**

**\*HYPERCROSS/XT TRS80 - CP/M - MS-DOS File Transfer\***

Now you can **CROSS** the barrier between computers! Using **HYPERCROSS** you can **COPY** files between TRS-80 disks and those from many different **CP/M** and **IBM-PC** type computers. If you have access to more than one kind of computer, or you are changing to a new machine then you need **HYPERCROSS** to transfer your text files, BASIC, FORTRAN PASCAL or C programs, Visicalc files, general ledger and accounting files, data bases and even binary files.

**HYPERCROSS** lets you do this directly on your own **TRS-80** or **MAX-80** without using cables. Just put a disk from a **CP/M** or **PC/MS-DOS** (Tandy 1000, 1200, 2000 too) in one drive and a **TRS-80** type **DOS** disk in another drive and you can copy files back and forth at will! You can copy multiple files in one go, and even copy directly from one alien disk format to another. You can also **FORMAT** an alien disk, display the **DIRECTORY**, and **KILL** files.

\***Formats supported:** IBM-PC and MS-DOS compatibles include DOS 1.1, 2.x/3.0 single and double sided and Tandy 2000. CP/M from Aardvark to Zorba, including Cromemco, DEC, Epson, HP, IBM CP/M 86, Kaypro, LNW, MAX-80 Morrow, NEC, Osborne, Otrona, Sanyo, Superbrain, Teletex, Teletek, Televideo, TRS-80: all Model I, III and IV CP/Ms, Xerox, Zenith plus many others. **New version XT/2.0-Plus supports an additional 100 formats including PC J-formats.**

**Hardware required:** 48K and 2 drives minimum, Model 1 needs a doubler. Some formats need double sided or 80 track drives. 80 track skip supported.

**PRICES** including disk, manual and shipping. We will match any advertised price.  
 Hypercross CP/M with 40 single sided formats ..... \$49.95  
 Hypercross PC/MS-DOS standard sided formats only ..... \$49.95  
 Hypercross XT 2.0 with 70 CP/M and PC formats ..... \$99.95  
 Hypercross XT 2.0-Plus. Now with 170 formats ..... \$129.95  
 Upgrade at any time for price difference plus \$5 plus old disk.

Please specify **TRS-80 Model I, III, 4/4P, or MAX-80.**

**HYPERZAP 3.2c Disk Magic!**

Do you want to back up your precious copy of Copycat 3 or SU. Do you want to fix or modify a disk - if so then you need **HYPERZAP!** On the market for over 2 years, **HYPERZAP** is more than just another disk copying program - it is the program for analyzing, copying, repairing, creating floppy disks or all kinds. It will copy any TRS-80 format as well as many others such as CP/M, PC, CoCo etc. Specially designed to handle mixed density sectors on any track in any sequence. Many features for reading, writing, editing track and sector data. **Hyperzap** is the tool that lets you be in charge.

**Make your own self booting disks.** Take your own CMD file and turn it into a dual booting Mod 1/III/IV disk. **Autopilot mode** allows learn, saves and repeats procedures. Disk comes with fascinating examples.

**Hardware needed:** 48K 1 drive minimum, One version for all TRS-80 models 1, 3 and 4. Manual and disk \$49.95 ppd. Separate **Max-80** version available.

**Arranger II Disk Index System**

World's finest disk cataloging system. At last you can find that file when you want it. Arranger will **CATALOG**, **SORT** and **FIND** up to 11000 files fast! Runs on any Model I, III or IV and automatically recognizes virtually any DOS even double sided ones!  
 Highly recommended - \$49.95 = \$3 ship

**HYPERSOFT**

PO Box 51155, Raleigh, NC 27609  
 (919) 847-4779 6-11 pm EST

Check, C.O.D., Mastercard and Visa Accepted.



**NEW PRODUCTS**

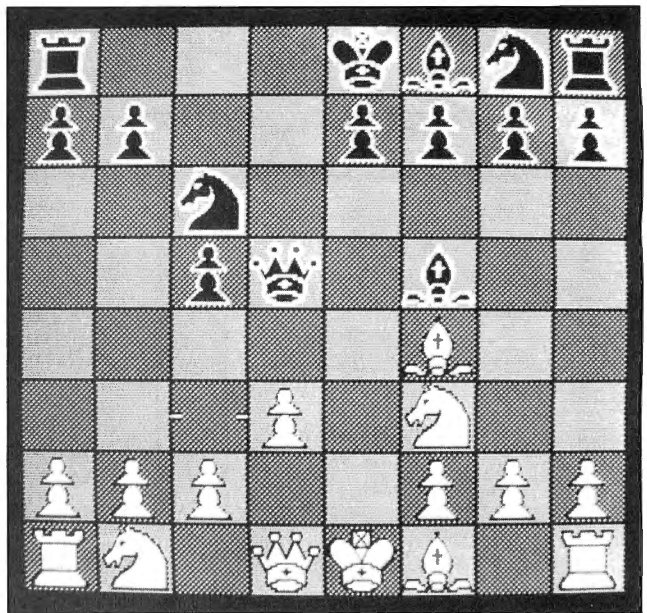

*Tournament Chess from Micro-Labs Inc.*

\$10.90 from Franklin Watts Inc., 387 Park Ave. S., New York, NY 10016, 212-686-7070.

Circle 554 on Reader Service card.

**Check Mate**

Tournament Chess (\$49.95) lets you play chess against a friend or the computer (Models I, III, 4, and 4P). The program uses standard block graphics. If you have a Micro-Labs or Radio Shack high-resolution board installed, the chessboard and pieces are highly detailed.

You can select the following playing levels at any time: Tournament, Rapid Transit, Mate Finder, and Postal. You can cancel a move, turn the board, print out the current board, and save an unfinished game. Tournament Chess is fast and provides complete game control with over 40 execution options and features. For more details, contact Micro-Labs Inc., 902 Pinecrest, Richardson, TX 75080, 214-235-0915.

Circle 558 on Reader Service card.

**No More Surges**  
 Perma Power Electronics has two Socket Plus rack-mount surge suppressors for under \$100 to protect sensitive circuitry from power line voltage transients. Both suppressors have six outlets and a shutdown

**No More Surges**

Both suppressors have six outlets and a shutdown



**NEW PRODUCT FOR AUTOMATION**

**USE YOUR TRS-80 MODEL III, IV or 4P:**

- For direct measurement of: voltage, or alarm conditions
- With one resistor to measure: current, resistance, or 4-20 ma. signals
- With transducers to measure: acceleration, dewpoint, force, humidity, pH, position, pressure, temperature, velocity, viscosity, wind speed or direction
- With interfaces to turn power on/off, control analog voltage, motor speed, temperature, etc.

Note: We also manufacture the Model 100 A/D for the TRS-80\* Model 100 Computer MODEL III, IV, or 4P—A/D, converter and digital interface for your TRS-80\* Model III or IV:

- 0 to 4.096 volts full scale (adjustable)
- 12 bit integrating A/D converter (.025%)
- 16 analog voltage input
- 8 digital inputs, expansion to 24 bits
- 8 digital outputs, expansion to 24 bits
- 3 addressable output strobes

Price: \$580 including software (\$5.00 for manual)

**HUMPHREY INSTRUMENTS, INC.**  
 301 N. Harrison St., Suite 191  
 Princeton, N.J. 08540  
 (609) 896-1612

\*TRS-80 is a trademark of The Tandy Corporation

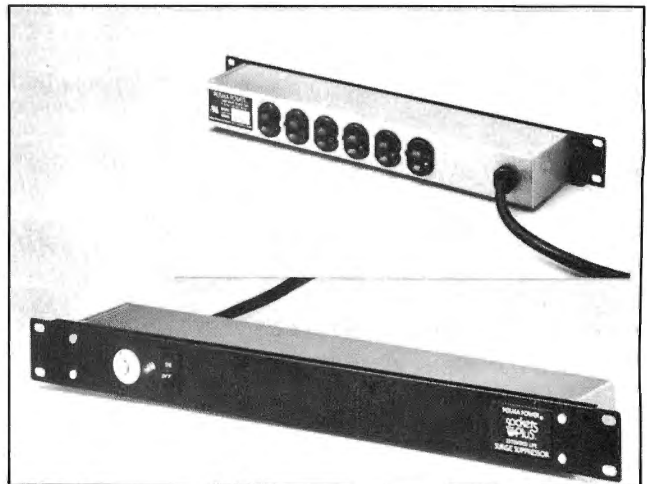

*Socket Plus surge suppressor protects sensitive circuitry.*



# Nibble Theory

**A Short Term Strategy for Making a Small Profit Everyday.**

Send **\$39.95** for complete "Nibble Theory" Software Package and detailed explanation of how to nibble money out of the stock market on a daily basis. (MOD III/IV only).

**DATA COVER INC.** 3657 HiDale • Lake Orion, MI 48035  
Call or write Dept F

## MODULAR I/O PORT KITS

PARALLEL 8 BIT INPUT & OUTPUT •  
MODELS I, III, 4 & CoCo

MODULAR DESIGN FOR ADDITION OF MULTIPLE PORTS  
LATCHED OUTPUT STATUS MONITORED BY LED'S  
SWITCH SELECTABLE I/O ADDRESS  
SOFTWARE DIAGNOSTICS

**I/O PORT KIT INCLUDES...**  
4.5" x 6" Printed circuit board; All components;  
Cable (connects to bus expansion port);  
Diagnostic software listing (Basic); and Manual.  
(Requires 5V 100ma supply)

|                                    |             |
|------------------------------------|-------------|
| <b>J107K Complete I/O Port Kit</b> | <b>\$35</b> |
| <b>D100K 5 Volt Power Supply</b>   | <b>\$25</b> |
| <b>J202K A-D/D-A Interface</b>     | <b>\$35</b> |
| <b>J105K Buffer Board Kit</b>      | <b>\$25</b> |
| <b>J112K Model III/4 Adaptor</b>   | <b>\$20</b> |
| <b>J110K CoCo Adaptor</b>          | <b>\$15</b> |

(1 J105K FREE FOR EVERY 4 J107K'S ORDERED)  
SEND CHECK OR MONEY ORDER

**D & A Research**  
400 Wilson Avenue  
Satellite Beach, Florida 32937  
305-777-1728

## PROFILE III PLUS / 4 PLUS USERS!!

**PROAID III + / 4 + Gives You New Relational Reporting Capabilities:**

- \*Print fields from up to three related files at the same time
- \*Use up to four fields from any segments of related files to sort and select records
- \*Print up to 60 lines per record (132 wide)
- \*Print multiple records per page
- \*Print records 1 or 2 up with printer control code
- \*Print grand totals and record count
- \*Print master record with multiple related detail records
- \*Print existing screens in report format
- \*Print field information

Programs use existing Profile files.  
Price includes documentation and 30 day guarantee:

|              |            |
|--------------|------------|
| PROAID III + | \$95       |
| PROAID 4 +   | write/call |

Write for more information or send check or money order to:

**Clay Watts Software**  
68C North Loop  
Cedar Hill, TX 75104  
214-291-1171

*Profile is a trademark of Tandy Corp.*

**NEW! Lower Prices!!**

# wabash

six-year warranted

## DISKETTES!

**\$9.80/box (10)**

5 1/4" single-side, single-density; double-density add \$2/box. Add \$3 per order shipping. In Illinois add 7% sales tax.

**Library Case-\$1.75** (with disk purchase)  
Immediate shipment on VISA, MasterCard or Money order; add 14 days for personal checks.

**CALL TOLL FREE**  
**(800) 222-1248**

**In Illinois Call (312) 882-8315**

**DEALERS! SCHOOLS! USER GROUPS!**  
Call for our volume discount prices!

## DIGITAL IMAGES

1185 Tower, Schaumburg IL 60195

# PRINTER OWNERS

Letters are received here on a regular basis from customers saying how much they really enjoy receiving our lists.

It's probably safe to say that the price lists issued here are different from most of the others. Maybe it's the chatty folksy style of writing? Perhaps it's the low, almost unbelievable, prices on printer cartridges? Again, it could be dealing with a dealer that understands the hobby Computer user and really cares about what you think?

Send your name and address today for a rather fat envelope of printer and computer related offers.

**ZYGOTRON**  
P.O. Box 27  
Fremont, Michigan 49412

## Micro Data Products

1-800-423-5414

# maxell BASF

|                       |            |                |
|-----------------------|------------|----------------|
| MD-2 5 1/4" DSDD 2.16 | Box of 10  | DS DD 1.65 5/4 |
| MD-1 5 1/4" SSDD 1.50 | --         | SS DD 1.45 5/4 |
| MD-2 5 1/4" DSDD 1.75 | Bulk Pack- | DS DD 1.36 5/4 |
| MD-1 5 1/4" SSDD 1.45 | ing        | SS DD 1.20 5/4 |

**MAXELL**  
3.5" 4.36 5/4 DSHD 4.10  
Pre Paid COD's accepted  
Orders shipped within 24 hours  
Shipping & handling charges vary  
TN. residents add 7.75% sales tax  
In TN. call 1-615-553-0521  
545 Haymarket Rd. Clarksville, TN 37043  
Prices subject to change

# MODEM80

## Communications Package

*The most complete and versatile communications package of its kind.*

Available versions are:

TRS-80 I/III ..... only \$39.95 + \$2.00 S&H  
LOBO MAX80 ..... only \$49.95 + \$2.00 S&H  
TRS-80 4/4P ..... only \$79.95 + \$2.00 S&H

All versions are supplied on 5 1/4" disk and include full documentation.

For additional information or to order contact:

**The ALTERNATE CHOICE**  
9505 W. Brown Deer Rd.  
Milwaukee, WI 53224  
(414) 355-4544

C.O.D. service available for a \$3.00 additional charge. Sorry no charge cards.

# INTELLIBURNER

EPROM-EEPROM-MICROCONTROLLER PROGRAMMER

**\$299 (Cable \$12)**

Communicates through the serial port of any personal computer. Use your PC's modem software to read, verify, or program all popular EPROMs, EEPROMs and 87xx series microcontrollers. Custom software included for most popular PCs (source included).

Other serial programmers available from **\$149**. Bare PC boards with software from **\$39**.

**ROSS CUSTOM ELECTRONICS**  
1307 Darlene Way-Suite A12  
Boulder City, Nevada 89005  
702-293-7426  
Add \$3 Shipping and Handling COD's OK

# wabash

**When it comes to Flexible Disks, nobody does it better than Wabash.**

MasterCard, Visa Accepted.  
Call Free: (800) 235-4137

**PACIFIC EXCHANGES**  
100 Foothill Blvd.  
San Luis Obispo, CA  
93401 (In Cal. call  
(805) 543-1037)

# DISKETTE CLEARANCE

Here's your chance to save BIG BUCKS on first-quality disks made by America's top manufacturers for their private label customers. Field Magnetics has warehoused thousands of these FACTORY-SEALED disks and can pass tremendous savings on to you.

ALL DISKS ARE SURFACE-TESTED, CERTIFIED ERROR-FREE, AND EXCEED ANSI STANDARDS. IF YOU ARE NOT COMPLETELY SATISFIED WITH THESE DISKS, YOU MAY RETURN THEM TO FIELD MAGNETICS, INC. WITHIN 30 DAYS FOR A FULL REFUND. OUR OWN LIFETIME WARRANTY APPLIES TO ALL DISKS. (Copy of warranty available upon request.)



**5 1/4"** In boxes of 10 disks

SSSD, compares to \$26.00  
now **\$8.50**  
SSDD, compares to \$29.00  
now **\$9.50**  
DSDD, compares to \$40.00  
now **\$11.00**

**8"** for TRS 80\*  
In boxes of 10 disks

SSSD, compares to \$33.00  
now **\$12.50**  
SSDD, compares to \$39.50  
now **\$15.00**  
DSDD, compares to \$45.00  
now **\$20.00**

\*Soft-sectored. Full range of hard-sectored disks available; please write or call.

First come, first served, so order today. This offer is good only as long as our supply lasts!

We ship UPS. Add \$2.00 for first box, \$1.00 each additional. If ordering by phone, please have credit card # and expiration date ready. We accept Visa, MasterCard, American Express, money orders, and checks.

**FIELD  
MAGNETICS  
I N C.**

5865 SW 21st St., W. Hollywood, FL 33023. Call (305) 962-0707.

# Moving?

## Subscription Problems?

Get help with your subscription by calling our new toll free number:

# 1-800-645-9559\*

between 9 a.m. and 5 p.m. EST, Monday-Friday. If possible, please have your mailing label in front of you as well as your cancelled check or credit card statement if you are having problems with payment.

If moving, please give both your old and new addresses.

\*New York State residents call 1-800-732-9119.

## NEW PRODUCTS

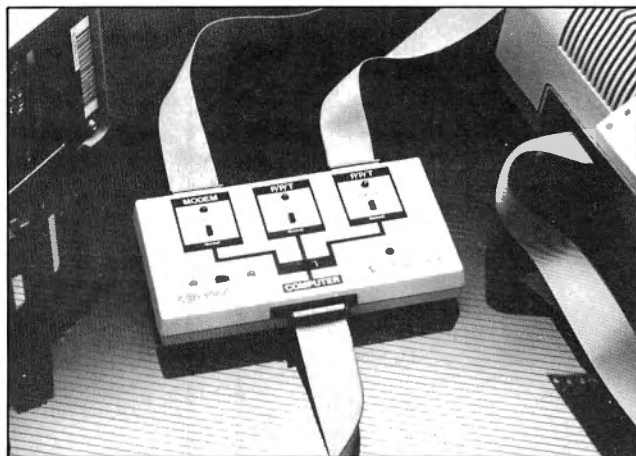

Connect a modem and two printers to your computer with The Smart Switch Box.

mechanism that prevents you from using unprotected equipment in the event of suppression element failure.

Model JT06BO (\$63.70) offers single-stage suppression using three metal oxide varistors, while model JS06BO (\$92.50) has two-stage filters and uses both metal oxide varistors and silicon avalanche diodes.

For more information, contact Perma Power Electronics, 5615 W. Howard St., Chicago, IL 60648, 312-647-9414.

Circle 560 on Reader Service card.

### Back-Up in a Snap

Snapback copies Xenix, TRSDOS, and CP/M data from any Tandy 8.7-, 12-, 15-, and 35-megabyte hard disk to any Model II/12/16/6000 floppy drive at a rate of 1.5 to 2.4 megabytes per minute, without any hardware modifications.

The package includes two bootable disks and documentation. It costs \$125 plus \$7.50 for handling/shipping. For more information, contact Pickles & Trout, P.O. Box 1206, Goleta, CA 93116, 805-685-4641.

Circle 563 on Reader Service card.

### School Days

Scholarships Today (Module I) gives you a list of financial aid programs sponsored by the federal and state government.

You will learn about Pell grants, guaranteed student loans, Plus loans, supplement-

tal educational opportunity grants, college work-study programs, national direct student loans, and sources of state aid.

For each type of financial aid, the exercises cover eligibility criteria, dollar amount available, application procedures, and deadlines. The program also writes custom letters of inquiry and includes a financial aid quiz.

Scholarships Today (\$65) runs on the Models III and 4. For more information, contact Jefferson Software, Systems Software Associates Inc., 723 Kanawha Blvd. E., Charleston, West Virginia 25301, 304-342-0769.

Circle 573 on Reader Service card.

### Smart Connection

The Smart Switch Box (SSB1000) connects a modem and two peripherals to a single computer. It has one computer port and three peripheral ports (one dedicated to modems).

The Smart Switch Box uses straight-through 25-wire ribbon cables to make the correct RS-232 interconnection between the computer and the peripherals. It also indicates which piece of equipment is disabling data transfer if this type of problem occurs.

The box retails for \$159.95. For more information, contact IQ Technologies Inc., 11811 N.E. First St., Suite 308, Bellevue, WA 98005, 206-451-0232.

Circle 570 on Reader Service card.



## NEW PRODUCTS

Circle 476 on Reader Service card.

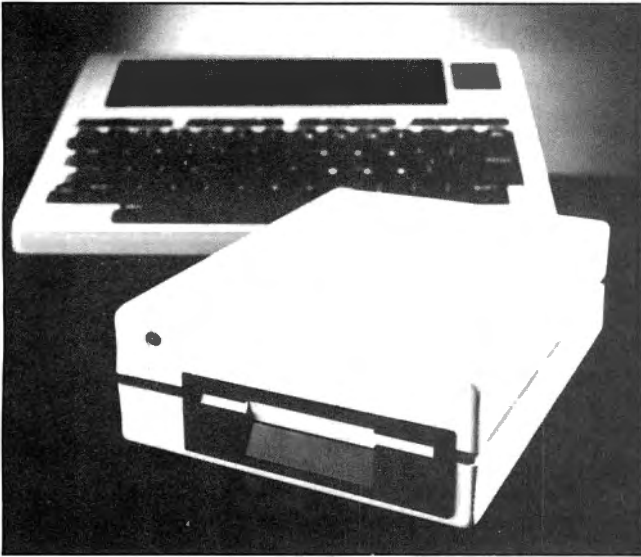

The Chipmunk now comes bundled with software.

### Pocket That Drive

Portable Computer Support Group Inc. sells Holmes Engineering's Chipmunk portable disk drive for the Models 100 and 200 bundled with six helpful programs for \$599.

The drive weighs 3½ pounds and uses 3½-inch 358K disks. The software includes data base, invoice, sort, telecommunications, calendar, and personal finance programs.

Contact Portable Computer Support Group (11035, Harry Hines Blvd., #207, Dallas, TX 75229, 214-351-0564) for more information.

Circle 569 on Reader Service card.

### Security Blanket

Computer Security Institute offers Computer Security Issues and Answers, a 24-page magazine supplement, for free. It contains eight articles that cover planning, computer crime prevention, society's responsibility for data security, legal aspects, software security, and disaster recovery.

Send requests, together with a self-addressed 9- by 12-inch envelope with 73 cents postage affixed, to Phyllis St. Martin, Computer Security Institute, 43 Boston Post Rd., Northborough, MA 01532.

Circle 571 on Reader Service card.

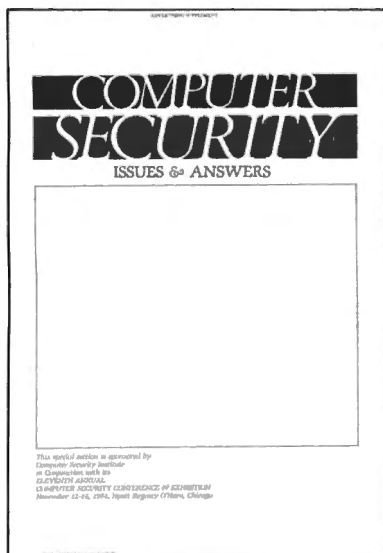

Get this 24-page supplement free from the Computer Security Institute.



## MULTIDOS 80/64 - FOR THE MODEL 4

**New for your Model 4...A completely unique DOS...Not a rehash of TRSDOS 6...Not just another Model III DOS...A totally redesigned operating system for your Model 4.**

- flip between 64 and 80 characters on the screen; 32 and 40 character widths also available
- runs Model III software
- use your extra 64K memory as a MEMDISK; automatically sets up MEMDISK as system disk, allowing use of the 0 drive for a data disk
- for 4P owners, never load MODELIII/A file again!
- disk I/O code written for Model 4; get fewer errors than you get using a Model III DOS
- a much faster BASIC; many enhancements and debugging tools
- over 41000 free bytes of memory in BASIC
- runs BASIC programs written for the Model III in 64 characters, or easily modified to 80 characters
- write programs using 80 character screen, function keys, and extra memory
- keyboard returns an extended character set; user controllable
- includes all the new features in 1.7 MULTIDOS

MULTIDOS 80/64 reads many disk formats, including all Model I/III DOS' and TRSDOS 6. If you're a Model III owner thinking about upgrading, this makes the transition easy.

MULTIDOS 80/64 .....\$99.95

### NEW VERSION MULTIDOS FOR MODEL I/III \$89.95

- includes a MEMDISK - set aside part of memory as a disk file
- for double-sided drives, select either one or two volume operation
- handles 8 inch drives
- all the great features of 1.6, including compatibility with all other DOS', plus many enhancements

NOTE: MULTIDOS 80/64 does not run TRSDOS 6 programs

# INTRODUCING



## A NEW VERSION OF LAZY WRITER

**NEW IMPROVED** printer customization - automatic underlining, bold, different type sizes, super/subscript with almost any printer...over 20 NEW printer commands

**SELF INSTALLING** on any Model I or III DOS for TRS-80 I, III, 4 (or use Model 4 version on TRSDOS 6)

**SAME PRICE....**Lazy Writer 3.5 is only \$124.95

AlphaBit Communications, Inc.

☎call (313) 581-2896

13349 Michigan Ave.  
Dearborn, Michigan 48126

# THE RS-232

**MODEL III                      MODEL 4**



TRS-80 MODEL III  
TRS-80 Model 4  
RS-232 SERIAL INTERFACE  
MODIFICATION KIT

Manual Number 5108-002

**CompuLogic**

State of the art technology in board design, our direct replacement of Radio Shack's internal RS-232 board, mounts inside the Model III or 4 on the existing brackets. All cables, screws and complete mounting instructions are included. Non-technical people will find that installation is quick, straight forward and simple requiring less than 15 minutes to complete.

Total compatibility with Radio Shack and all existing software is maintained. Software programmable baud rates from 50 to 19,200 baud are supported along with programmable word length, stop bits, and parity. May be utilized in either half of full duplex operation.

**Outstanding Value  
At  
Only \$69.95**

Guaranteed One Full Year  
Dealer Inquiries invited

Please forward payment by a cashier's  
check or money order.

Visa or Mastercharge also accepted.

Add \$3.00 shipping & handling  
(Foreign orders quoted on request)

**CompuLogic**

4831 SOUTH HAMPTON RD. LB41  
DALLAS, TEXAS 75232  
214/390-1332

## NEW PRODUCTS

### DIFFERENT TRACK

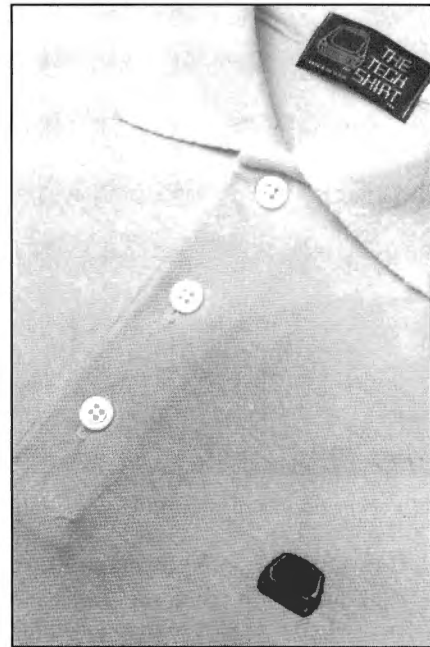

High-tech shirt from Sweet Gum Inc.

#### Wash 'n' Ware

The Tech Shirt (\$18.95 plus \$1.50 for shipping) is a major breakthrough in software technology. It represents a graphic statement between man and computer.

The pullover shirt is perfect for summer and casual wear. It's available in red and navy blue, in both men's and women's sizes (S, M, L, and XL). The shirts are made of 50 percent cotton and 50 percent polyester.

Contact Sweet Gum Inc. (15490 N.W. 7th Ave., Miami, FL 33169, 800-237-9338) for more information.

Circle 564 on Reader Service card.

# NEW FROM 80 MICRO Classifieds

## GET THE ATTENTION YOU DESERVE

Tell more than 200,000 dedicated, interested TRS-80 users about your product or service with an efficient and economical **80 Micro** classified ad.

You'll reach the most people in the market for the least amount of money!

With **80 Micro's** well-established audience of involved buyers, sellers, and swappers, your ad is bound to get fast results!

For more information, write to:

**80 Micro**

Attn. Classified Manager  
80 Pine Street  
Peterborough, NH 03458

## New Products Index

| Reader Service Number | Company                                | Page |
|-----------------------|----------------------------------------|------|
| 555                   | The Alternate Source                   | 118  |
| 571                   | Computer Security Institute            | 123  |
| 572                   | En Fleur Corp.                         | 118  |
| 554                   | Franklin Watts Inc.                    | 118  |
| 561                   | Institute for Scientific Analysis Inc. | 118  |
| 570                   | IQ Technologies Inc.                   | 122  |
| 573                   | Jefferson Software                     | 122  |
| 565                   | Logical Systems Inc.                   | 118  |
| 558                   | Micro-Labs Inc.                        | 120  |
| 559                   | MicroMedia                             | 118  |
| 569                   | Portable Computer Support Group Inc.   | 123  |
| 560                   | Perma Power Electronics                | 120  |
| 563                   | Pickles & Trout                        | 122  |
| 557                   | Scilab Inc.                            | 118  |
| 567                   | Sharp Electronics Corp.                | 118  |
| 564                   | Sweet Gum Inc.                         | 124  |

New Products listings are based on information supplied in manufacturers' press releases. 80 Micro has not tested or reviewed these products and cannot guarantee any claims.



## MS-DOS NEW PRODUCTS

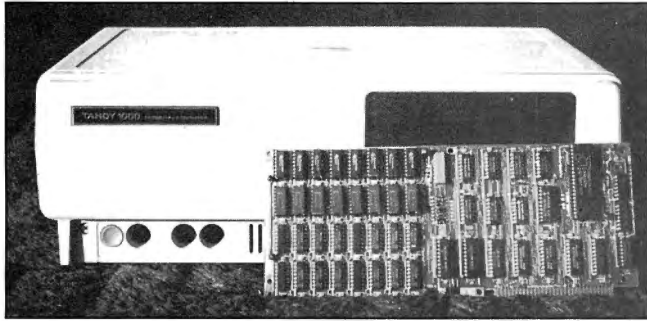

The 4N1 card uses one slot on the Model 1000 for four functions.

### Memory Lane

Micro Mainframe's multi-function memory card, the 4N1, lets you add up to 512K of additional memory to your Model 1000, thereby giving you the 1000's direct memory access feature, and includes a free RS-232 serial port.

The 4N1 also accepts an optional real-time clock module and/or an optional mouse, giving you four functions while using but a single expansion slot.

The card (with the serial

port) comes in four versions: without additional memory (\$259.95) and with 128K (\$309.95), 256K (\$469.95), or 512K (\$649.95).

Direct inquiries to Micro Mainframe, 11285-E Sunrise Gold Circle, Rancho Cordova, CA 95670, 916-635-3997.

Circle 556 on Reader Service card.

### Super Rescue

Powersoft Products, makers of Super Utility Plus, has released an MS-DOS version of their disk utility for the

Models 1000, 1200, and 2000.

In addition to restoring lost data, Super Utility provides diagnostic sector checking, sector modification in hexadecimal or ASCII mode, sector to file copying, string searching of files or raw sector data, and more. It supports both color and monochrome monitors.

The price is \$89.95. Contact Powersoft Products (17060 Dallas Parkway, Suite 114, Dallas, TX 75248, 214-733-4475) for more information.

Circle 551 on Reader Service card.

### Around the World

Software Concepts Inc. puts a 3-D four-color world globe on the screen of the Models 1000, 1200, and 2000 (128K required).

Atlas (\$69.95) also provides geographic facts on more than 3,500 cities and displays the current cursor latitude and longitude. On request, it can identify the city



Software Concepts Inc.'s Atlas puts the globe at your fingertips.

closest to the cursor, find distances between cities, and list facts on population, currency, languages, and so on. You can also rotate the globe and zoom in or out.

For more information, contact Software Concepts Inc., 1116 Summer St., Stamford, CT 06905, 203-357-0522.

Circle 553 on Reader Service card.

Circle 464 on Reader Service card.

## Grafyx Solution™ Save \$100.00 High-Resolution Graphics for Mod 4/4P/III

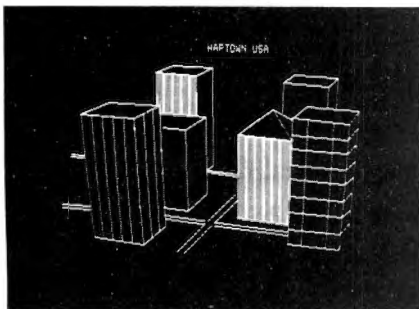

**Superior Hardware.** The Grafyx Solution provides 153,600 pixel elements which are arranged in a 640 x 240 or on the Model III a 512 x 192 matrix. Hundreds of new business, personal, engineering, and educational applications are now possible. The hi-res display can be shown on top of the standard display containing text, special characters, and block graphics. This simplifies program debugging, text labeling, and upgrading current programs to use graphics. The Grafyx Solution fits completely within any tape or disk based Model 4, 4P, or III. Installation is easy with the plug-in, clip-on board.

**Superior Basic.** Over 20 commands are added to the Basic language. These commands will set, clear or complement points, lines, boxes, circles, ellipses, or arcs. The hi-res screen can be printed on any of 20 popular printers or saved or loaded to disk without leaving Basic. Areas may be filled in with any of 256 patterns. Sections of the screen may be saved and then put back using any of five logical functions. Labels can be printed in any direction. The viewing area can be changed. The entire screen can be complemented or cleared. Graphics Basic provides dot densities of 640 x 240, 320 x 240, 160 x 240, and 160 x 120, all of which can be used in the same display.

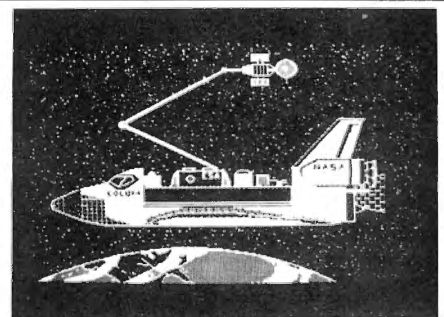
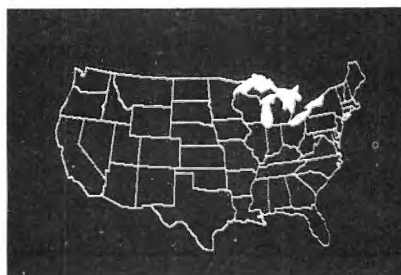

**Superior Software.** The board comes with over 40 programs and files which make it easier to use, serve as practical applications, demonstrate its capabilities, and serve as programming examples. The software works with TRSDOS 1.3, 6.1.2, 6.2, LDOS, NEW-DOS80, and DOSPLUS. The Grafyx Solution is also supported by a number of optional applications programs: Draw, Bizgraph, xT.CAD, 3D-Plot, Mathplot, Surface Plot, Biorhythm & USA, Music.

The Grafyx Solution package is shipped complete for \$199.95 (reduced from \$299.95). A manual for review is \$15. Payment may be by check, Visa/MC, or COD. Domestic shipping is free on pre-paid orders. Texas residents add 5% tax.

**MICRO-LABS, INC.** 214-235-0915  
902 Pinecrest, Richardson, Texas 75080

## MS-DOS NEW PRODUCTS

### Account on It

Dac Software Inc. offers Dac-Easy, seven accounting modules (general ledger, accounts receivable, accounts payable, inventory, purchase order, billing, and forecasting) on one Model 1000, 1200, or 2000 MS-DOS disk for \$49.95.

Among the program's special features are automatic forecasting without a spreadsheet, keeping up to three years of history, multilevel accounting, and flexible report formats. For more information, contact Dac Software Inc., 1550 Peterson, Suite 130, Dallas, TX 75240, 214-458-0038.

Circle 566 on Reader Service card.

### Music for Your Computer

Quartet (\$399.95) is an integrated, menu-driven accounting system for the Models 1000, 1200, and 2000. The user interface makes this package special. When you enter payroll data,

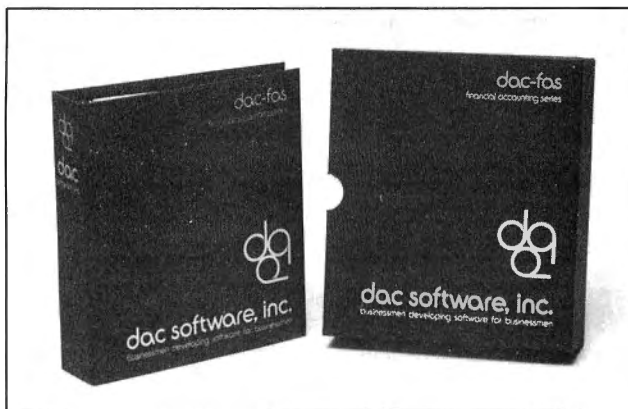

Dac-Easy, an accounting package for the Models 1000, 1200 and 2000.

the screen displays a time-card. You pay bills by filling in on-screen check forms, and you fill in accounts receivable on a screen invoice. In addition, the package provides a general ledger program.

You need two disk drives and 256K to run Quartet. For more information, contact Tandy Corp./Radio Shack, 1800 One Tandy Center, Fort

Worth, TX 76102.

Circle 562 on Reader Service card.

### Seven in One

The Ultimate (\$149.95) is an integrated package of seven Model 1000, 1200, or 2000 applications: word processing, data base manager, mail merger, dictionary, sort, electronic mail, and Western Union Easy Link. All the programs work together.

The package requires 96K RAM, one 360K disk drive, a parallel printer, a modem, and a monochrome monitor. It's available at Radio Shack stores.

For additional information, contact Computer Creations Inc., 6861 Convoy Court, San Diego, CA 92111, 619-277-8822.

Circle 568 on Reader Service card.

### A Mystical Adventure

Icon (\$49.95) is a new color graphics adventure game from Macrocom for the IBM PCs and PC-compatibles, including the 128K Models 1000 and 1200. In the quest for the ring you journey through dungeons in search of mystical icons. You have to fight vampire bats, fierce kobolds, ghosts, and other monsters.

For more information, contact Macrocom Inc., P.O. Box 70012, Marietta, GA 30007, 800-622-8086.

Circle 552 on Reader Service card.

Circle 227 on Reader Service card.

# NEW And IMPROVED CP/M-68K

Treat your TRS-80 Model-16 or Enhanced Model-II or -12 to our new Version 1.2 CP/M-68K, now with:

- **Keyboard Typeahead**
- **C compiler with standard and IEEE floating point**
- **Overlay loader**
- **New utilities**
- **68000 assembler**

Option languages\* — CBASIC-68K, PASCAL MT+, FORTRAN-77, PASCAL-68K, BASIC-68K

Version 1.1 users; order a language and receive your version 1.2 upgrade FREE. Upgrade alone only \$25.

## Trisoft

4102 Avenue G  
Austin, Texas 78751  
(512) 453-2233

\*Requires 256 kbytes minimum except for BASIC-68K.





## MS-DOS NEW PRODUCTS

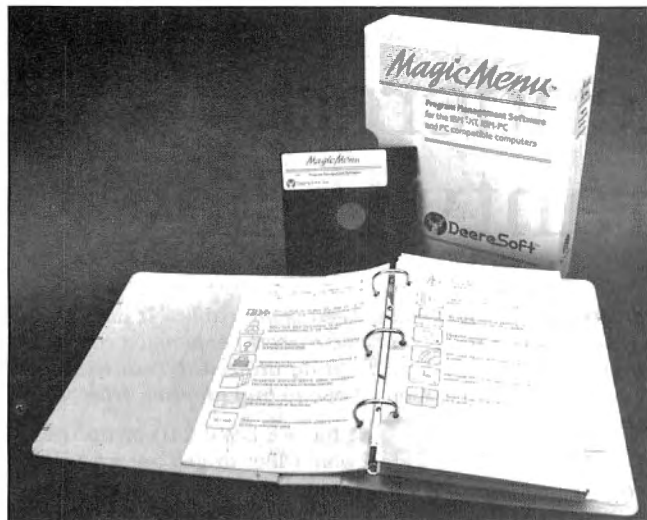

*Magic Menu comes between you and MS-DOS.*

### Menu, Menu On the Wall

Magic Menu (\$99) is a menu system that lets you select and execute over 1,000 applications programs with a few keystrokes, without dealing with MS-DOS (version 2.0 or later) or consulting a manual.

The system interfaces between you and the DOS so you can call any application. Sequence screens let you automatically execute a series of menu entries, and password security is available for all applications.

Magic Menu can be made memory resident so you can

use it on systems without a fixed disk. You can select the presentation format for each menu screen in the system. Presentation format choices include black and white or color screen, foreground, background, and border colors, date/time display, and

menu character size.

Magic Menu works with 128K on the Models 1000 and 1200HD. For more information, contact DeereSoft Inc., P.O. Box 1360, Melbourne, FL 32901, 305-768-2477.

Circle 574 on Reader Service card.

## MS-DOS New Products Index

| Reader Service Number | Company                 | Page |
|-----------------------|-------------------------|------|
| 568                   | Computer Creations Inc. | 126  |
| 566                   | DAC Software Inc.       | 126  |
| 574                   | DeereSoft Inc.          | 127  |
| 552                   | Macrocom Inc.           | 126  |
| 556                   | Micro Mainframe         | 125  |
| 551                   | PowerSoft Products      | 125  |
| 553                   | Software Concepts Inc.  | 125  |
| 562                   | Tandy/Radio Shack       | 126  |

*New Products listings are based on information supplied in manufacturers' press releases, 80 Micro has not tested or reviewed these products and cannot guarantee any claims.*

# THE CLASSIFIED 80micro

### DISKS & SUPPLIES

**Disks, Program Packaging.** Low prices on BASF, Memorex, Verbatim, Dysan. Binders, Slips like Tandy 1000, 2000. Much more. Free Catalog. Anthropomorphic, 376 East Saint Charles, Lombard, IL 60148 (312) 629-5160.

**Wholesale Computer Paper** • You'll appreciate the savings • FREE Catalog Progressive Programming P.O. Box 98 Grove City, OH 43123.

**Dollar Diskettes!** DS/DD w/Hub ring. Dollar Brand are available in packs of 10 for \$10.00. Add \$2.00 postage and handling to total order. No minimum no maximum lifetime gar-

antee. 4831 S. Hampton, LB-41 Dallas, TX 75232.

### SERVICES

**128K Upgrade, \$69.95** installed. Co-Co 2 64K Upgrade, \$44.95 installed. Call for best repair rates. Paulin Computer Service. 501-869-2626.

**Get the attention you deserve.** 80 Micro is now offering classified ads at a special introductory price. Reach over 100,000 readers with news of your product or service. Classified ads on the pages of 80 Micro get results. Write to 80 Micro 80 Pine St. Peterborough, NH 03458 attn: Classified manager for information and deadlines.

### PUBLICATIONS

**Close-out Sale!** TRS-80 Encyclopedia by Wayne Green Inc. 10 volume hardcover was \$199.50 now \$79.99. 10 volume softcover was \$109.50 now \$58.99. Mail to DiskCount Data see page 31 for address.

**The Kepner Letter**, from the author of Feedback Loop and Campbell Communications. Has the most timely Hardware, Software and book news for the TRS-80 Computers. Special Offer. Call (603) 924-9450 for information, or write to 145 Grove St. Peterborough, NH 03458.

Circle 549 on Reader Service Card

### SOFTWARE

**Coin Collectors!** Unique program uses built-in market value file and prices your U.S. collection. Brochure available. Compu-Quote 6914 Berquist, Catnoga Park, CA 91307 (818) 348-3662.

### HARDWARE

**Modular I/O Port Kits.** Parallel 8 bit input & output. Models I, III, 4 and CoCo. Modular design for addition of multiple ports. J107K complete I/O port kit \$35 D100K 5 volt power supply \$25 J202K A-D/D-A Interface \$35 J105K Buffer Board Kit \$25 J112K Model III/4 Adaptor \$20 J110K CoCo Adaptor \$15 D&A Research, 400 Wilson Ave. Satellite Beach, FL 32937. 305-777-1728

# Services Rendered: Tandy's Warranty Policy

Send your questions dealing specifically with Tandy products, services, or policies to Ask Tandy, 80 Micro, 80 Pine St., Peterborough, NH 03458. A representative at Tandy's Fort Worth, TX, headquarters supplies all answers published here.

**Q:** I'm in the market for a Tandy 1000. Some companies advertise Tandy products at discounts, but I hear that Tandy might not service products bought by mail order. What's the real story?

**A:** Our standard warranty covers any Tandy product as long as you're the original owner and you bought it from a Radio Shack Computer Center, store, or authorized dealer. Your original sales slip is the vehicle by which you get warranty service; nothing else is valid. Making a purchase by mail doesn't affect the warranty. My suggestion, however, is always to deal with your local outlet, on which you'll lean for support. We require Radio Shack company-owned stores to provide service and support in a timely manner for all products bought through any authorized channel.

**Q:** I've read that the Tandy 2000's MS-Assembler doesn't support two Intel 80186 instructions, PUSHA and POPA. Why?

**A:** The assembler's manufacturer, Microsoft, didn't support those commands. Tandy didn't push for them, in order to insure some software compatibility between the 2000 and our 8088-based computers, the Tandy 1200 HD and 1000. I'm told Microsoft has a new assembler that does support those instructions, but I don't know when it will become available. Also, we haven't decided if you'll see it as a Tandy product.

**Q:** Will Tandy transfer Model III disk-based software to Model I format if a customer requests it?

**A:** When a Model III program worked reasonably well on the Model I, Tandy usually made it available for the I. However, some Model III programs just wouldn't run in the amount of disk space available on a Model I.

You could always transfer a program from a III to a I via an RS-232 port. But if we didn't offer the program for the I, it's likely you wouldn't be pleased with the results. And no, we don't offer a conversion service.

**Q:** SuperScript has a problem: When one document contains multiple line spacings, it prints out correctly, but the line number on the status line is wrong. Will you fix it?

**A:** On investigation, we found that the problem could be solved, but at the cost of slowing SuperScript's overall operation significantly. Our merchandising people decided to leave the current version as-is. If and when we do a major rewrite of SuperScript, fixing that problem is definitely on our wish list.

**Q:** I need help with a serious Tandy 1000 problem. With a monochrome monitor, when MS-DOS boots up, the display's intensity is inadequate, even with the brightness control set to maximum. I know MS-DOS's Mode CO command, or Basic's SCREEN 0,1 will improve it, but what do I do when running IBM PC software?

**A:** You're right about the problem. Two possibilities. First, we can do a hardware modification; check with your local repair facility. Second, as you boot up, press the F12 key when the buzzer sounds. That makes the computer think you're using a color monitor, forcing a higher intensity configuration at the monochrome port.

**Q:** I bought a pretty complete Tandy 1000 system. After receiving the hard disk drive board I ordered, I'm upset to find that it works only with a secondary hard disk drive and not with the 15-megabyte primary drive I already have. Nobody told me this. What am I supposed to do now?

**A:** The difference between a primary and a secondary 15-megabyte hard disk drive is that the former contains a controller board; the latter doesn't. On the Tandy 1000, the board you bought is the controller. It should be easy to convert your primary drive to a secondary one. All it takes is disconnecting the controller card; also,

you'll need some cables. It does mean you have a pretty expensive controller board sitting unused, but at least you won't have to buy another drive.

**Q:** I have a DWP-210 printer, and I would like to get colored printer ribbons: blue, brown, and so forth. But I can't find them anywhere. Why? Not to be able to order a \$6 ribbon is almost ridiculous.

**A:** While we realize some customers would kill for ribbons of a particular color, we've found the demand isn't enough to justify our producing them. The DWP-210 ribbon is a standard Diablo Hy-Type II ribbon. The ribbons you want should be easy to find in distribution.

**Q:** I completely disagree with your response on sending out customer support letters to registered TRS-80 owners (February 1985, p. 144). I've been a registered owner of a Model I, and I have yet to receive one word about it.

**A:** That's probably because we haven't sent out anything. The program started long after Tandy discontinued the Model I. It's a software registration program. The only Model I package for which we mailed a notice was the Model III version of SuperScript. We contact owners only when we have a software update notice.

**Q:** Will Tandy be coming out with a 128K upgrade for the Color Computer?

**A:** No.

A couple of notes: In the June 1985 issue, I answered a question about getting replacements for lost software manuals. I said they were available on a case-by-case basis. Wrong. Tandy's policy changed about a year ago. Replacement software manuals aren't available under any circumstances. We've joined other industry leaders like Microsoft and Lotus in an attempt to discourage software piracy. Sorry for misleading you.

Also, I've gotten several questions about products that are available for more than one Tandy computer. When you write with a question, please specify what computer you own. ■



# MEMORY MINDER T.M.

... A UNIQUE APPROACH TO DISK RELIABILITY!

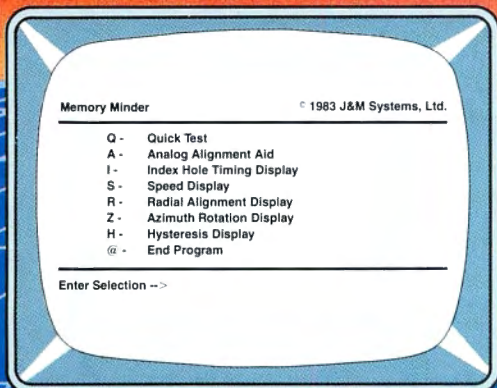

Select any one of seven tests to perform preventive maintenance or to isolate problems. Simple, single-letter commands make MM easy to use! Use MM to align the head, adjust the index hole detector, or adjust the speed.

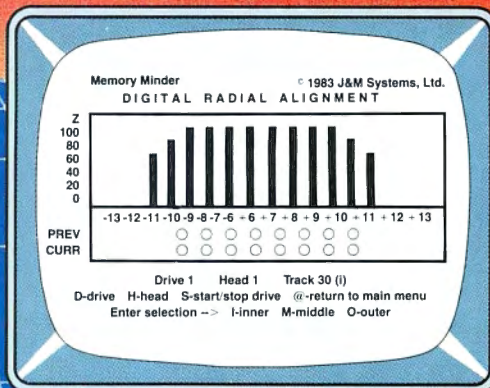

Use the MM Radial Alignment Test to check the head alignment of your drives. No need for an oscilloscope or other expensive test equipment!

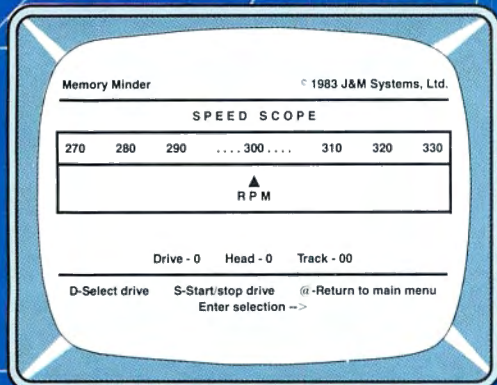

Check the motor speed of your drives. Or, you can even use the Speed Test to adjust the drive speed. No need for any test equipment!

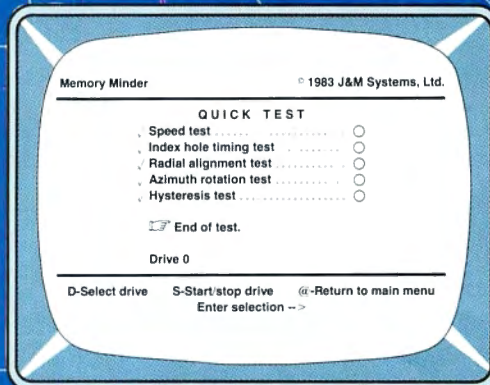

Use the Quick Test to quickly and automatically test five of the most important performance parameters of your drive. Monitor your drives for long term drift. Isolate problems quickly and automatically!

## PROTECT YOUR DATA.

Now you can make sure your data is being recorded properly by the use of the revolutionary *Memory Minder*.

The Memory Minder from J & M Systems, tests your disk's performance and calibration without any additional equipment! It measures your disk's performance and displays it on your screen.

This is the most comprehensive disk diagnostic program available for your TRS-80 microcomputer. You can even adjust drive alignment while watching the display!

Spot problems *before* they endanger your data! If you own a disk drive, you *need* the *Memory Minder*!

|                                            | Price # |
|--------------------------------------------|---------|
| <b>TRS-80 Model III/4</b>                  |         |
| 1 - 48 tpi Single Side (Standard)          | \$79    |
| 2 - 48 tpi Double Side                     | \$89    |
| 3 - 96 tpi Double Side                     | \$129   |
| Includes 48 tpi & 96 tpi program diskettes |         |
| <b>TRS-80 Model -I</b>                     |         |
| 1 - 48 tpi Single Side Single Density      | \$89    |
| <b>TRS-80 Color Computer and TDP-100</b>   |         |
| 1 - 48 tpi Single Side (Standard)          | \$79    |
| 2 - 48 tpi Double Side                     | \$99    |

MM also available for other models

J & M SYSTEMS IS THE DRIVING FORCE!



**J & M SYSTEMS, LTD.**  
 15100-A CENTRAL SE  
 ALBUQUERQUE, NEW MEXICO 87123  
 505/292-4182



# Introducing the Most Powerful Business Software Ever!

TRS-80™ (Model I, II, III, or 16) • APPLE™ • IBM™ • OSBORNE™ • CP/M™ • KAYPRO™

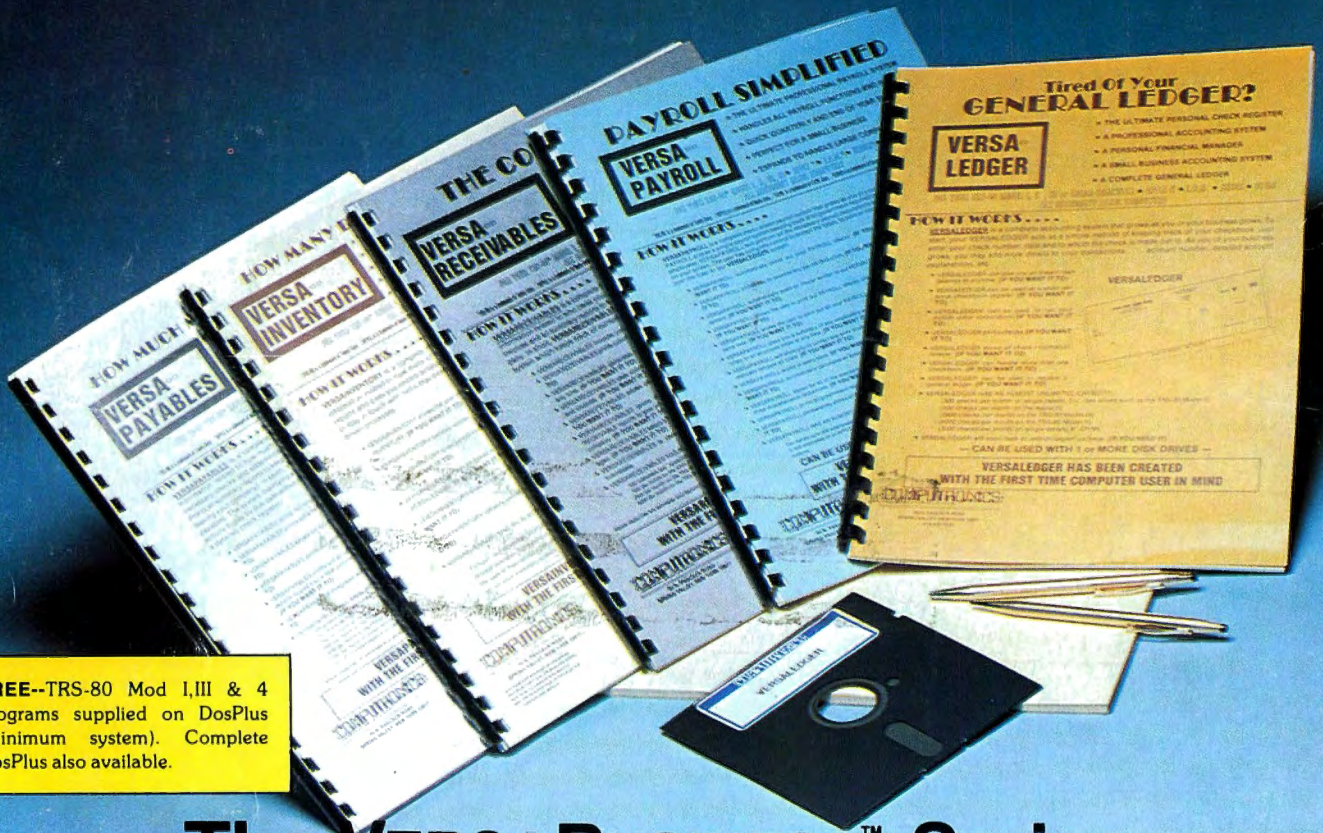

**FREE--TRS-80 Mod I, III & 4 programs supplied on DosPlus (minimum system). Complete DosPlus also available.**

## The VERSABUSINESS™ Series

Each VERSABUSINESS module can be purchased and used independently, or can be linked in any combination to form a complete, coordinated business system.

**VERSARECEIVABLES™** \$99.95  
 VERSARECEIVABLES™ is a complete menu-driven accounts receivable, invoicing, and monthly statement-generating system. It keeps track of all information related to who owes you or your company money, and can provide automatic billing for past due accounts. VERSARECEIVABLES™ prints all necessary statements, invoices, and summary reports and can be linked with VERSALEDGER II™ and VERSAINVENTORY™.

**VERSAPAYABLES™** \$99.95  
 VERSAPAYABLES™ is designed to keep track of current and aged payables, keeping you in touch with all information regarding how much money your company owes, and to whom. VERSAPAYABLES™ maintains a complete record on each vendor, prints checks, check registers, vouchers, transaction reports, aged payables reports, vendor reports, and more. With VERSAPAYABLES™, you can even let your computer automatically select which vouchers are to be paid.

**VERSAPAYROLL™** \$99.95  
 VERSAPAYROLL™ is a powerful and sophisticated, but easy to use payroll system that keeps track of all government-required payroll information. Complete employee records are maintained, and all necessary payroll calculations are performed automatically, with totals displayed on screen for operator approval. A payroll can be run totally, automatically, or the operator can intervene to prevent a check from being printed, or to alter information on it. If desired, totals may be posted to the VERSALEDGER II™ system.

**VERSAINVENTORY™** \$99.95  
 VERSAINVENTORY™ is a complete inventory control system that gives you instant access to data on any item. VERSAINVENTORY™ keeps track of all information related to what items are in stock, out of stock, on backorder, etc., stores sales and pricing data, alerts you when an item falls below a preset reorder point, and allows you to enter and print invoices directly or to link with the VERSARECEIVABLES™ system. VERSAINVENTORY™ prints all needed inventory listings, reports of items below reorder point, inventory value reports, period and year-to-date sales reports, price lists, inventory checklists, etc.

**VERSALEDGER II™** \$149.95  
 VERSALEDGER II™ is a complete accounting system that grows as your business grows. VERSALEDGER II™ can be used as a simple personal checkbook register, expanded to a small business bookkeeping system or developed into a large corporate general ledger system **without any additional software.**

- VERSALEDGER II™ gives you almost unlimited storage capacity (300 to 10,000 entries per month, depending on the system),
- stores all check and general ledger information forever,
- prints tractor-feed checks,
- handles multiple checkbooks and general ledgers,
- prints 17 customized accounting reports including check registers, balance sheets, income statements, transaction reports, account listings, etc.

VERSALEDGER II™ comes with a professionally-written 160 page manual designed for first-time users. The VERSALEDGER II™ manual will help you become quickly familiar with VERSALEDGER II™, using complete sample data files supplied on diskette and more than 50 pages of sample printouts.

### SATISFACTION GUARANTEED!

Every VERSABUSINESS™ module is guaranteed to outperform all other competitive systems, and at a fraction of their cost. If you are not satisfied with any VERSABUSINESS™ module, you may return it within 30 days for a refund. Manuals for any VERSABUSINESS™ module may be purchased for \$25 each, credited toward a later purchase of that module. All CP/M-based Computers must be equipped with Microsoft BASIC (MBASIC or BASIC-80)

**To Order:**  
 Write or call Toll-free (800) 431-2818  
 (N.Y.S. residents call 914-425-1535)

- \* add \$3 for shipping in UPS areas
- \* add \$5 to CANADA or MEXICO
- \* add \$4 for C.O.D. or non-UPS areas
- \* add proper postage elsewhere

DEALER INQUIRIES WELCOME

All prices and specifications subject to change / Delivery subject to availability.



# COMPUTRONICS!

50 N. PASCACK ROAD, SPRING VALLEY, N.Y. 10977